

This Base Manual covers 19,20,22 Cu. Ft.
Bottom Mount Refrigerators
Refer to individual Technical Sheet for
information on specific models.

Service

19, 20 & 22 Cu. Ft. Bottom Mount Refrigerators

Service Manual for Amana® and Maytag® models

This manual is to be used by qualified appliance technicians only. Maytag does not assume any responsibility for property damage or personal injury for improper service procedures done by an unqualified person.

MAYTAG®

16021484
Revision 1
July 2002

Important Information

Pride and workmanship go into every product to provide our customers with quality products. It is possible, however, that during its lifetime a product may require service. Products should be serviced only by a qualified service technician who is familiar with the safety procedures required in the repair and who is equipped with the proper tools, parts, testing instruments and the appropriate service manual. **REVIEW ALL SERVICE INFORMATION IN THE APPROPRIATE SERVICE MANUAL BEFORE BEGINNING REPAIRS.**

Important Notices for Consumers and Servicers



WARNING

To avoid risk of serious injury or death, repairs should not be attempted by unauthorized personnel, dangerous conditions (such as exposure to electrical shock) may result.



CAUTION

Maytag will not be responsible for any injury or property damage from improper service procedures. If performing service on your own product, assume responsibility for any personal injury or property damage which may result.

To locate an authorized servicer, please consult your telephone book or the dealer from whom you purchased this product. For further assistance, please contact:

MAYTAG APPLIANCES SALES COMPANY **OR**
ATTN: Maytag CAIR® Center **CALL**
P.O. Box 2370
Cleveland, TN 37320-2370

U.S. and Canada 1-800-462-9824
U.S. customers using TTY for deaf, hearing
impaired, call 1-800-688-2080

If outside the United States contact:

MAYTAG APPLIANCES SALES COMPANY
ATTN: Maytag CAIR® Center
P.O. Box 2370
Cleveland, TN 37320-2370
Telephone: 1-800-462-9824

Recognize Safety Symbols, Words, and Labels



DANGER

DANGER—Immediate hazards which **WILL** result in severe personal injury or death.



WARNING

WARNING—Hazards or unsafe practices which **COULD** result in severe personal injury or death.



CAUTION

CAUTION—Hazards or unsafe practices which **COULD** result in minor personal injury or product or property damage.

Table of Contents

Important Information	2	System Diagnosis	27
Product Design	4	Disassembly Procedures	
Component Testing	5	Fresh Food Door	30
Service Procedures	10	Freezer Door	30
Service Equipment	10	Refrigerator Compartment	
Drier Replacement	10	Light Bulb	30
Refrigerant Precautions	11	Light Bulb Assembly	30
Line Piercing Valves	11	Light Bulb Sockets	31
Open Lines	11	Defrost Timer	31
Compressor Operational Test	11	Light Switch	31
Dehydrating Sealed Refrigeration System	12	Temp- Assure™ Damper control	31
Leak Testing	12	Water Tank	31
Testing Systems Containing a		Water Dispenser	32
Refrigerant Charge	12	Freezer Compartment	
Testing Systems Containing		Freezer Temperature Control	32
No Refrigerant Charge	12	Light Socket	32
Restrictions	13	Light Switch	32
Symptoms	13	Freezer Back Panel	32
Testing for Restrictions	13	Evaporator Fan Blade and Fan Motor	32
Evacuation and Charging	14	Defrost Terminator (thermostat)	33
Evacuation	14	Defrost Heater	33
Charging	15	Evaporator Removal	33
Refrigerant Charge	15	Drawer Assembly	34
HFC134a Service Information	16	Drawer Rails	34
Health, Safety, and Handling	16	Front roller assembly	34
Comparison of CFC12 and HFC134a Properties	16	Rear roller assembly.....	34
Replacement Service Compressor	17	Machine Compartment	
Compressor Testing Procedures	17	Condenser Fan and Fan motor	34
Brazing	17	Compressor	34
Refrigerant Flow 19, 20, 22 cu. ft	18	Overload/Relay/Capacitor	34
Cabinet Air Flow 19, 20, 22 cu. ft	19	Condensate Drain Pan	35
20 cu. ft Machine Compartment Air Flow Diagram	20	Condensate Drain Tube	35
19, 22 cu. ft Machine Compartment Air Flow Diagram	21	Condenser Removal	35
Water Dispenser Flow	22	Appendix A	
Typical External Sweat Pattern.....	23	Owner's Manual	A-2
Troubleshooting Chart.....	24	Appendix B	
		Ice Maker Installation and Operation	B-2

Product Design



WARNING

To avoid risk of electrical shock, personal injury, or death, disconnect electrical power source to unit, unless test procedures require power to be connected. Discharge capacitor through a resistor before attempting to service. Ensure all ground wires are connected before certifying unit as repaired and/or operational.

Refrigeration System

Compressor forces high temperature vapor into fan cooled tube and wire condenser where vapor is cooled and condensed into high pressure liquid by circulation of air across condenser coil. (See Refrigerant Flow Diagram, page 18)

High pressure liquid passes into post-condenser loop which helps to prevent condensation around freezer compartment opening and through molecular sieve drier and into capillary tube. Small inside diameter of capillary offers resistance, decreasing pressure, and temperature of liquid discharged into evaporator. Capillary diameter and length is carefully sized for each system.

Capillary enters evaporator at top front. Combined liquid and saturated gas flows through front to bottom of coil and into suction line. Aluminium tube evaporator coil is located in freezer compartment where circulating evaporator fan moves air through coil and into fresh food compartment.

Large surface of evaporator allows heat to be absorbed from both fresh food and freezer compartments by airflow over evaporator coil causing some of the liquid to evaporate. Temperature of evaporator tubing near end of running cycle may vary from -13° to -25° F.

Saturated gas is drawn off through suction line where superheated gas enters compressor. To raise temperature of gas, suction line is placed in heat exchange with capillary.

Temperature Controls

Freezer compartment temperature is regulated by air sensing thermostat at top front of freezer compartment which actuates compressor. Control should be set to maintain freezer temperature between 0° to -2° F.

Fresh food compartment temperature is regulated by an air damper control governing amount of refrigerated air entering fresh food compartment from freezer. Fresh food compartment temperature should be between 38° and 40° F.

Defrost System

Every 8 hours of compressor run time defrost timer activates radiant electric defrost heater suspended from evaporator. After 33 minutes of defrost cycle time, timer restores circuit to compressor.

Defrost terminator (thermostat) is wired in series with defrost heater. Terminator opens and breaks circuit when preset high temperature is reached. After defrost thermostat opens, thermostat remains open until end of defrost cycle when cooling cycle starts and terminator senses present low temperature and closes.

Defrost heater is suspended on left side of evaporator coil and across bottom to keep defrost drain free flowing during defrost. Defrost water is caught in trough under evaporator coil and flows through drain hole in liner and drain tubing into drain pan. Air circulated by condenser fan over pan evaporates water.

Component Testing



WARNING

To avoid risk of electrical shock, personal injury, or death, disconnect electrical power source to unit, unless test procedures require power to be connected. Discharge capacitor through a resistor before attempting to service. Ensure all ground wires are connected before certifying unit as repaired and/or operational.



Component	Description	Test Procedures
<div data-bbox="188 474 329 632" data-label="Image"> </div> <p data-bbox="164 401 285 428">Compressor</p>	<p data-bbox="345 401 745 625">When compressor electrical circuit is energized, the start winding current causes relay to heat. After an amount of starting time, the start winding circuit turns off. The relay will switch off the start winding circuit even though compressor has not started (for example, when attempting to restart after momentary power interruption).</p> <p data-bbox="345 646 745 766">With "open" relay, compressor will not start because there is little or no current to start windings. Overload protection will open due to high locked rotor run winding current.</p> <p data-bbox="345 787 745 907">With "shorted" relay or capacitor, compressor will start and overload protector will quickly open due to high current of combined run and start windings.</p> <p data-bbox="345 928 745 1014">With open or weak capacitor, compressor will start and run as normal but will consume more energy.</p>	<p data-bbox="745 401 911 428">Resistance test</p> <ol data-bbox="745 428 1521 573" style="list-style-type: none"> 1. Disconnect power to unit. 2. Discharge capacitor by shorting across terminals with a resistor for 1 minute. <p data-bbox="745 474 1292 501">NOTE: (Some compressors do not have a run capacitor.)</p> <ol data-bbox="745 501 1521 674" style="list-style-type: none"> 3. Remove leads from compressor terminals. 4. Set ohmmeter to lowest scale. 5. Check for resistance between <ul data-bbox="841 573 1183 625" style="list-style-type: none"> Terminals "S" and "C", start winding Terminals "R" and "C", run winding <p data-bbox="745 625 1521 674">If either compressor winding reads open (infinite or very high resistance) or dead short (0 ohms), replace compressor.</p> <p data-bbox="745 680 873 707">Ground test</p> <ol data-bbox="745 707 1521 852" style="list-style-type: none"> 1. Disconnect power to refrigerator. 2. Discharge capacitor, if present, by shorting terminals through a resistor. 3. Remove compressor leads and use an ohmmeter set on highest scale. 4. Touch one lead to compressor body (clean point of contact) and other probe to each compressor terminal. <ul data-bbox="781 831 1466 852" style="list-style-type: none"> • If reading is obtained, compressor is grounded and must be replaced. <p data-bbox="745 861 898 888">Operation test</p> <p data-bbox="745 888 1484 936">If voltage, capacitor, overload, and motor winding tests do not show cause for failure, perform the following test:</p> <ol data-bbox="745 936 1521 1205" style="list-style-type: none"> 1. Disconnect power to refrigerator. 2. Discharge capacitor by shorting capacitor terminals through a resistor. 3. Remove leads from compressor terminals. 4. Wire a test cord to power switch. 5. Place time delayed fuse with UL rating equal to amp rating of motor in test cord socket. (Refer to Technical Data Sheet) 6. Remove overload and relay. 7. Connect start, common and run leads of test cord on appropriate terminals of compressor. 8. Attach capacitor leads of test cord together. If capacitor is used, attach capacitor lead to a known good capacitor of same capacity. <div data-bbox="971 1213 1300 1560" data-label="Diagram"> </div> <p data-bbox="745 1604 1521 1652">9. Plug test cord into multimeter to determine start and run wattage and to check for low voltage, which can also be a source of trouble indications.</p> <p data-bbox="745 1652 1521 1680">10. With power to multimeter, press start cord switch and release.</p> <ul data-bbox="781 1680 1521 1902" style="list-style-type: none"> • If compressor motor starts and draws normal wattage, compressor is okay and trouble is in capacitor, relay/overload, freezer temperature control, or elsewhere in system. • If compressor does not start when direct wired, recover refrigerant at high side. After refrigerant is recovered, repeat compressor direct wire test. If compressor runs after recovery but would not run when direct wired before recovery, a restriction in sealed system is indicated. • If compressor does not run when wired direct after recovery, replace faulty compressor.

Component Testing

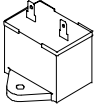

WARNING

To avoid risk of electrical shock, personal injury, or death, disconnect electrical power source to unit, unless test procedures require power to be connected. Discharge capacitor through a resistor before attempting to service. Ensure all ground wires are connected before certifying unit as repaired and/or operational.

Component	Description	Test Procedures
<p>Capacitor</p> 	<p>Run capacitor connects to relay terminal 3 and L side of line.</p> <p>Some compressors do not require a run capacitor; refer to the Technical Data Sheet for the unit being serviced.</p>	<div style="border: 1px solid black; padding: 5px; margin-bottom: 10px;">  <h3 style="margin: 0;">WARNING</h3> <p>To avoid electrical shock which can cause severe personal injury or death, discharge capacitor through a resistor before handling.</p> </div> <ol style="list-style-type: none"> 1. Disconnect power to refrigerator. 2. Remove capacitor cover and disconnect capacitor wires. 3. Discharge capacitor by shorting across terminals with a resistor for 1 minute. 4. Check resistance across capacitor terminals with ohmmeter set on "X1K" scale. <ul style="list-style-type: none"> • Good—needle swings to 0 ohms and slowly moves back to infinity. • Open—needle does not move. Replace capacitor. • Shorted—needle moves to zero and stays. Replace capacitor. • High resistance leak—needle jumps toward 0 and then moves back to constant high resistance (not infinity).
<p>Condenser</p>	<p>Condenser is a tube and wire construction located in machine compartment.</p> <p>Condenser is on high pressure discharge side of compressor. Condenser function is to transfer heat absorbed by refrigerant to ambient.</p> <p>Higher pressure gas is routed to condenser where, as gas temperature is reduced, gas condenses into a high pressure liquid state. Heat transfer takes place because discharged gas is at a higher temperature than air that is passing over condenser. It is very important that adequate air flow over condenser is maintained.</p> <p>Condenser is air cooled by condenser fan motor. If efficiency of heat transfer from condenser to surrounding air is impaired, condensing temperature becomes higher. High liquid temperature means liquid will not remove as much heat during boiling in evaporator as under normal conditions. This would be indicated by high than normal head pressures, long run time, and high wattage. Remove any lint or other accumulation, that would restrict normal air movement through condenser.</p> <p>From condenser the refrigerant flows into a post condenser loop which helps control exterior condensation on flange, center mullion, and around freezer door. Refrigerant the flows through the drier to evaporator and into compressor through suction line.</p>	<p>Leaks in condenser can usually be detected by using an electronic leak detector or soap solution. Look for signs of compressor oil when checking for leaks. A certain amount of compressor oil is circulated with refrigerant.</p> <p>Leaks in post condenser loop are rare because loop is a one-piece copper tube.</p> <p>For minute leaks</p> <ol style="list-style-type: none"> 1. Separate condenser from rest of refrigeration system and pressurize condenser up to a maximum of 235 PSI with a refrigerant and dry nitrogen combination. 2. Recheck for leaks. <div style="border: 1px solid black; padding: 5px; margin-top: 10px;">  <h3 style="margin: 0;">WARNING</h3> <p>To avoid severe personal injury or death from sudden eruption of high pressures gases, observe the following: Protect against a sudden eruption if high pressures are required for leak checking. Do not use high pressure compressed gases in refrigeration systems without a reliable pressure regulator and pressure relief valve in the lines.</p> </div>

Component Testing



WARNING

To avoid risk of electrical shock, personal injury, or death, disconnect electrical power source to unit, unless test procedures require power to be connected. Discharge capacitor through a resistor before attempting to service. Ensure all ground wires are connected before certifying unit as repaired and/or operational.

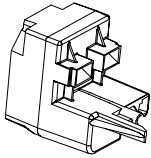
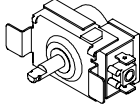
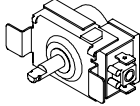
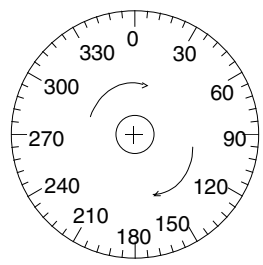
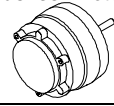
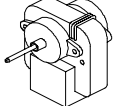

Component	Description	Test Procedures														
 <p>Overload / Relay</p>	<p>When voltage is connected and relay is cool, current passes through relay to start winding.</p> <p>After a short time, current heats the resistor in relay and resistance will rise blocking current flow through relay.</p> <p>Start winding remains in the circuit through run capacitor.</p> <p>Solid state relay plugs directly on compressor start and run terminals. Relay terminals 2 and 3 are connected within relay. Run capacitor is connected to relay terminal 3. L2 side of 120 VAC power is connected to relay terminal 2.</p>	<ol style="list-style-type: none"> 1. Disconnect power to the refrigerator. 2. Remove relay cover and disconnect leads. 3. Check resistance across terminals 2 and 3 with an ohmmeter: Normal = 3 to 12 ohms Shorted = 0 ohms Open = infinite ohms 														
 <p>Freezer temperature control</p>	<p>Freezer temperature control is a capillary tube operating a single pole, single throw switch.</p> <p>Freezer temperature control controls run cycle through defrost timer.</p>	<p>Check for proper calibration with thermocouple capillary in air supply well by recording cut-in and cut-out temperatures at middle setting. Refer to tech sheet for model being serviced for expected temperatures.</p> <p>Check control contacts are opening by disconnecting electrical leads to control and turning control knob to coldest setting. Check for continuity across terminals.</p>														
 <p>Altitude Adjustment</p>	<p>When altitude adjustment is required on a G.E. control, turn altitude adjustment screw 1/7 turn counter clockwise for each 1,000 feet increase in altitude up to 10,000 feet. One full turn equals 10,000 feet maximum.</p> <p>In most cases the need for altitude adjustments can be avoided by simply turning temperature control knob to colder setting.</p>	<table border="1"> <thead> <tr> <th colspan="2">Altitude Counter in Feet</th> </tr> <tr> <th>Feet Above Sea Level</th> <th>Turn Screw Clockwise (Angular Degrees)</th> </tr> </thead> <tbody> <tr> <td>2,000</td> <td>30</td> </tr> <tr> <td>4,000</td> <td>81</td> </tr> <tr> <td>6,000</td> <td>129</td> </tr> <tr> <td>8,000</td> <td>174</td> </tr> <tr> <td>10,000</td> <td>216</td> </tr> </tbody> </table> 	Altitude Counter in Feet		Feet Above Sea Level	Turn Screw Clockwise (Angular Degrees)	2,000	30	4,000	81	6,000	129	8,000	174	10,000	216
Altitude Counter in Feet																
Feet Above Sea Level	Turn Screw Clockwise (Angular Degrees)															
2,000	30															
4,000	81															
6,000	129															
8,000	174															
10,000	216															
Ice maker	<p>Optional on some models.</p> <p>See "Ice Maker" section for service information.</p>															
 <p>Condenser motor</p>	<p>Condenser fan moves cooling air across condenser coil and compressor body.</p> <p>Condenser fan motor is in parallel circuit with compressor.</p>	<p>Check resistance across coil.</p>														
 <p>Evaporator fan motor</p>	<p>Evaporator fan moves air across evaporator coil and throughout refrigerator cabinet.</p>	<ol style="list-style-type: none"> 1. Disconnect power to unit. 2. Disconnect fan motor leads. 3. Check resistance from ground connection solder. Trace to motor frame must not exceed .05 ohms. 4. Check for voltage at connector to motor with unit in refrigeration mode and compressor operating. 														

Component Testing



WARNING

To avoid risk of electrical shock, personal injury, or death, disconnect electrical power source to unit, unless test procedures require power to be connected. Discharge capacitor through a resistor before attempting to service. Ensure all ground wires are connected before certifying unit as repaired and/or operational.

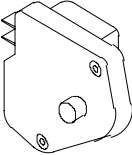

Component	Description	Test Procedures
Switch, refrigerator light, freezer light 	Single pole, single throw switch completes circuit for light when door is open.	Check resistant across terminals. Switch arm depressed "NO" terminals Open Switch arm up "NO" terminals Closed
Drier 	Drier is placed at post condenser loop outlet and passes liquefied refrigerant to capillary. Desiccant (20) 8 x 12 4AXH - 7 M>S> - Grams	<p>Drier must be changed every time the system is opened for testing or compressor replacement.</p> <p>NOTE: Drier used in R12 sealed system is not interchangeable with drier used in R134a sealed system. Always replace drier in R134a system with Amana part number B2150504.</p> <p>Before opening refrigeration system, recover HFC134a refrigerant for safe disposal.</p> <ol style="list-style-type: none"> Cut drier out of system using the following procedure. Do not unbraid drier. Applying heat to remove drier will drive moisture into the system. Score capillary tube close to drier and break. Reform inlet tube to drier allowing enough space for large tube cutter. Cut circumference of drier 1/4" below condenser inlet tube joint to drier. Remove drier. Apply heat trap paste on post condenser tubes to protect grommets from high heat. Unbraid remaining part of drier. Remove drier from system. Discard drier in safe place. Do not leave drier with customer. If refrigerator is under warranty, old drier must accompany warranty claim. <div style="border: 1px solid black; padding: 5px; margin-top: 10px;">  <h3>WARNING</h3> <p>To avoid death or severe personal injury, cut drier at correct location. Cutting drier at incorrect location will allow desiccant beads to scatter. If spilled, completely clean area of beads.</p> </div>
Defrost timer 	Timer motor operates only when freezer control is closed. After specified amount of actual operating time, inner cam in timer throws the contacts from terminal 4, compressor circuit, to terminal 2, defrost thermostat/defrost heater circuit. After specified defrost cycle time, timer cam resets the circuitry through terminal 4 to compressor.	<ol style="list-style-type: none"> To check timer motor winding, check for continuity between terminals 1 and 3 of timer. Depending on rotating position of the cam, terminal 1 of timer is common to both terminal 2, the defrost mode, and terminal 4, the compressor mode. There should never be continuity between terminals 2 and 4. With continuity between terminals 1 and 4, rotate timer knob clockwise until audible click is heard. When the click is heard, reading between terminals 1 and 4 should be infinite and there should be continuity between terminals 1 and 2. Continuing to rotate time knob until a second click is heard should restore circuit between terminals 1 and 4.

Component Testing

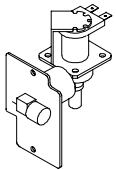

WARNING

To avoid risk of electrical shock, personal injury, or death, disconnect electrical power source to unit, unless test procedures require power to be connected. Discharge capacitor through a resistor before attempting to service. Ensure all ground wires are connected before certifying unit as repaired and/or operational.

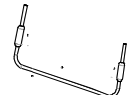
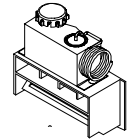
Component	Description	Test Procedures
 <p>Water valve</p>	<p>Controls water flow to the ice maker.</p> <p>Controlled by thermostat in ice maker.</p> <p>See Ice Maker Section for further information.</p>	<p>Check resistance across coil windings.</p>
<p>Evaporator</p>	<p>Inner volume of evaporator allows liquid refrigerant discharged from capillary to expand into refrigerant gas.</p> <p>Expansion cools evaporator tube and fin temperature to approximately -20°F transferring heat from freezer section to refrigerant.</p> <p>Passing through suction line to compressor, the refrigerant picks up superheat (a relationship between pressure and temperature that assures complete vaporization of liquid refrigerant) as the result of capillary tube soldered to suction line.</p> <p>Refrigerant gas is pulled through suction line by compressor, completing refrigeration cycle.</p>	<p>Test for leaks in evaporator with electronic leak detector or with soap solution. Compressor oil is circulated with refrigerant; check for oil when checking for leaks.</p> <p>For minute leaks</p> <ol style="list-style-type: none"> 1. Separate evaporator from rest of refrigeration system and pressurize evaporator up to a maximum of 140 PSI with a refrigerant and dry nitrogen combination. 2. Recheck for leaks.
 <h2>WARNING</h2> <p>To avoid severe personal injury or death from sudden eruption of high pressures gases, observe the following:</p> <ul style="list-style-type: none"> • Protect against a sudden eruption if high pressures are required for leak checking. • Do not use high pressure compressed gases in refrigeration systems without a reliable pressure regulator and pressure relief valve in the lines. 		
 <p>Evaporator heater (defrost)</p>	<p>Activated when defrost thermostat, defrost timer, and freezer control complete circuit through heater.</p>	<p>Check resistance across heater.</p> <p>To check defrost system :</p> <ol style="list-style-type: none"> 1. Thermocouple defrost thermostat and plug refrigerator into wattmeter. 2. Turn into defrost mode. Wattmeter should read specified watts (according to Technical Data Sheet). 3. When defrost thermostat reaches specified temperature $\pm 5^\circ\text{F}$ (see Technical Data Sheet), thermostat should interrupt power to heater.
<p>Thermostat (defrost)</p>	<p>Thermostat is in a series circuit with terminal 2 of defrost timer, and defrost heater. Circuit is complete if evaporator fan motor operates when cold.</p> <p>Controls the circuit from freezer thermostat through defrost terminator to defrost heater. Opens and breaks circuit when thermostat senses preset high temperature.</p>	<p>Test continuity across terminals.</p> <p>With power off and evaporator coil below freezing, thermostat should show continuity when checked with ohmmeter. See "Heater, evaporator (defrost)" section for additional tests.</p> <p>After defrost thermostat opens, thermostat remains open until end of defrost cycle and refrigerator starts cooling again. Defrost thermostat senses a preset low temperature and resets (closes).</p>
 <p>Damper control</p>	<p>Damper control balances the air delivery between refrigerator and freezer compartments providing temperature control for refrigerator.</p> <p>Internal capillary activates damper control and door closes restricting flow of air from freezer compartment to refrigerator compartment.</p>	<p>Subject capillary to appropriate temperature (refer to Technical Data Sheet for model being serviced).</p> <p>Damper door should close to within ¼" of completely shut.</p> <p>If altitude adjustment is required, turn altitude adjustment screw 1/8 turn clockwise for each 1,000 feet increase in altitude.</p> <p>There are no electrical connections to damper control. See Technical Data Sheet for damper specifications for unit being serviced.</p>

Service Procedures



WARNING

To avoid risk of electrical shock, personal injury, or death, disconnect electrical power source to unit, unless test procedures require power to be connected. Discharge capacitor through a 10,000 ohm resistor before attempting to service. Ensure all ground wires are connected before certifying unit as repaired and/or operational.

Service Equipment

Listed below is equipment needed for proper servicing of HFC134a systems. Verify equipment is confirmed by manufacturer as being compatible with HFC134a and ester oil system.

Equipment must be exclusively used for HFC134a. Exclusive use of equipment only applies to italic items.

- **Evacuation pump**

Check with vacuum pump supplier to verify equipment is compatible for HFC134a. Robinair, Model 15600 2 stage, 6 cubic feet per minute pump is recommended.

- ***Four-way manifold gauge set, with low loss hoses***

- **Leak detector**

- ***Charging cylinder***

- ***Line piercing saddle valve***

(Schroeder valves). Seals must be HFC134a and ester oil compatible. Line piercing valves may be used for diagnosis but are not suitable for evacuation or charging, due to minute holes pierced in tubing. Do not leave mechanical access valves on system.

Valves eventually will leak. Molecules of HFC134a are smaller than other refrigerants and will leak where other refrigerants would not.

- ***Swagging tools***

- ***Flaring tools***

- ***Tubing cutter***

- **Flux**

- **Sil-Fos**

- **Silver solder**

- ***Oil for swagging and flaring***

Use only part # R0157532

- ***Copper tubing***

Use only part # R0174075 and # R0174076

- **Dry nitrogen**

99.5% minimum purity, with -40°F or lower dew point

- **Crimp tool**

- **Tube bender**

- **Micron vacuum gauge**

- ***Process tube adaptor kit***

- **Heat trap paste**

- ***ICI appliance grade HFC134a***

Drier Replacement

Before opening refrigeration system, recover HFC134a refrigerant for safe disposal.

Every time sealed HFC134a system is repaired, drier filter must be replaced with, part # B2150504.

Cut drier out of system by completing the following steps. Do not unbrazed drier filter. Applying heat to remove drier will drive moisture into system.



WARNING

To avoid risk of severe personal injury or death, cut drier at correct location. Cutting drier at incorrect location will allow desiccant beads to scatter. Completely clean area of beads, if spilled.

1. Score capillary tube close to drier and break.
2. Reform inlet tube to drier allowing enough space for large tube cutter.
3. Cut circumference of drier at 1-1/4", below condenser inlet tube joint to drier.
4. Remove drier.
5. Apply heat trap paste on post condenser tubes to protect grommets from high heat.
6. Unbrazed remaining part of drier. Remove drier from system.
7. Discard drier in safe place. Do not leave drier with customer. If refrigerator is under warranty, old drier must accompany warranty claim.

Service Procedures



WARNING

To avoid risk of electrical shock, personal injury, or death, disconnect electrical power source to unit, unless test procedures require power to be connected. Discharge capacitor through a 10,000 ohm resistor before attempting to service. Ensure all ground wires are connected before certifying unit as repaired and/or operational.

Refrigerant Precautions



WARNING

To avoid risk of personal injury, do not allow refrigerant to contact eyes or skin.



CAUTION

To avoid risk of property damage, do not use refrigerant other than that shown on unit serial number identification plate.

NOTE: All precautionary measures recommended by refrigerant manufacturers and suppliers apply and should be observed.

Line Piercing Valves

Line piercing valves can be used for diagnosis, but are not suitable for evacuating or charging due to holes pierced in tubing by valves.

NOTE: Do not leave line piercing valves on system. Connection between valve and tubing is not hermetically sealed. Leaks will occur.

Open Lines

During any processing of refrigeration system, never leave lines open to atmosphere. Open lines allow water vapor to enter system, making proper evacuation more difficult.

Compressor Operational Test

(short term testing only)

If compressor voltage, capacitor, overload, and motor winding tests are successful (do not indicate a fault), perform the following test:

1. Disconnect power to unit.
 2. Discharge capacitor by shorting capacitor terminals through a resistor.
- NOTE:** Not all units have run capacitor.
3. Remove leads from compressor terminals.
 4. Attach test cord to compressor windings.
 - Common lead on test cord attaches to C terminal on compressor.
 - Start lead on test cord attaches to S terminal on compressor.
 - Run lead on test cord attaches to M terminal on compressor.

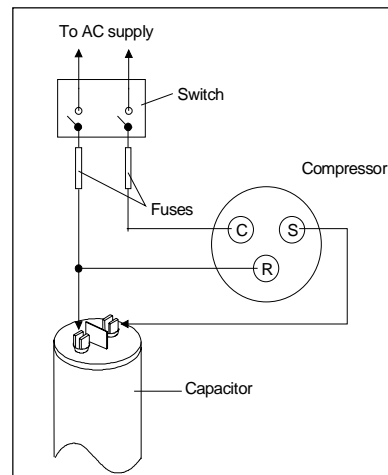

Attaching Capacitor for Compressor Test

5. Connect a known good capacitor into circuit as shown above. For proper capacitor size and rating, see technical data sheet for unit under test.

NOTE: Ensure test cord cables and fuses meet specifications for unit under test (see Technical Sheet for unit under test).

6. Replace compressor protector cover securely.
7. Plug test cord into outlet, then press and release start cord switch.



CAUTION

To avoid risk of damage to compressor windings, immediately disconnect (unplug) test cord from power source if compressor does not start. Damage to compressor windings occurs if windings remain energized when compressor is not running.

If compressor runs when direct wired, it is working properly. Malfunction is elsewhere in system.

If compressor does not start when direct wired, recover system at high side. After the system is recovered, repeat compressor direct wire test.

If compressor runs after system is recovered (but would not operate when wired direct before recovery) a restriction in sealed system is indicated.

If motor does not run when wired direct after recovery, replace faulty compressor.

Service Procedures



WARNING

To avoid risk of electrical shock, personal injury, or death, disconnect electrical power source to unit, unless test procedures require power to be connected. Discharge capacitor through a 10,000 ohm resistor before attempting to service. Ensure all ground wires are connected before certifying unit as repaired and/or operational.

Dehydrating Sealed Refrigeration System

Moisture in a refrigerator sealed system exposed to heat generated by the compressor and motor reacts chemically with refrigerant and oil in the system and forms corrosive hydrochloric and hydrofluoric acids. These acids contribute to breakdown of motor winding insulation and corrosion of compressor working parts, causing compressor failure.

In addition, sludge, a residue of the chemical reaction, coats all surfaces of sealed system, and will eventually restrict refrigerant flow through capillary tube.

To dehydrate sealed system, evacuate system (see paragraph *Evacuation*).

Leak Testing



DANGER

To avoid risk of serious injury or death from violent explosions, NEVER use oxygen or acetylene for pressure testing or clean out of refrigeration systems. Free oxygen will explode on contact with oil. Acetylene will explode spontaneously when put under pressure.

It is important to check sealed system for refrigerant leaks. Undetected leaks can lead to repeated service calls and eventually result in system contamination, restrictions, and premature compressor failure.

Refrigerant leaks are best detected with halide or electronic leak detectors.

Testing Systems Containing a Refrigerant Charge

1. Stop unit operation (turn refrigerator off).
2. Holding leak detector exploring tube as close to system tubing as possible, check all piping, joints, and fittings.

NOTE: Use soap suds on areas leak detector cannot reach or reliably test.

Testing Systems Containing No Refrigerant Charge

1. Connect cylinder of nitrogen, through gauge manifold, to process tube of compressor and liquid line strainer.
2. Open valves on nitrogen cylinder and gauge manifold. Allow pressure to build within sealed system.
3. Check for leaks using soap suds.

If a leak is detected in a joint, do not to attempt to repair by applying additional brazing material. Joint must be disassembled, cleaned and rebrazed. Capture refrigerant charge (if system is charged), unbrazed joint, clean all parts, then rebraze.

If leak is detected in tubing, replace tubing. If leak is detected in either coil, replace faulty coil.

Service Procedures



WARNING

To avoid risk of electrical shock, personal injury, or death, disconnect electrical power source to unit, unless test procedures require power to be connected. Discharge capacitor through a 10,000 ohm resistor before attempting to service. Ensure all ground wires are connected before certifying unit as repaired and/or operational.

Restrictions

Symptoms

Restrictions in sealed system most often occur at capillary tube or filter drier, but can exist anywhere on liquid side of system.

Restrictions reduce refrigerant flow rate and heat removal rate. Wattage drops because compressor is not circulating normal amount of refrigerants.

Common causes of total restrictions are moisture, poorly soldered joints, or solid contaminants. Moisture freezes at evaporator inlet end of capillary tube. Solid contaminants collect in filter drier.

If restriction is on low side, suction pressure will be in a vacuum and head pressure will be near normal.

If restriction is on high side, suction pressure will be in a vacuum and head pressure will be higher than normal during pump out cycle.

Refrigeration occurs on low pressure side of partial restriction. There will be a temperature difference at the point of restriction. Frost and/or condensation will be present in most case at the point of restriction. Also, system requires longer to equalize.

Slight or partial restriction can give the same symptoms as refrigerant shortage including lower than normal back pressure, head pressure, wattage, and warmer temperatures.

Total restriction on the discharge side of compressor, when restriction is between compressor and first half of condenser, results in higher than normal head pressure and wattage while low side is being pumped out.

Testing for Restrictions

To determine if a restriction exists:

1. Attach gauge and manifold between suction and discharge sides of sealed system.
2. Turn unit on and allow pressure on each side to stabilize. Inspect condenser side of system. Tubing on condenser should be warm and temperature should be equal throughout (no sudden drops at any point along tubing).
 - If temperature of condenser tubing is consistent throughout, go to step 4.
 - If temperature of condenser tubing drops suddenly at any point, tubing is restricted at point of temperature drop (if restriction is severe, frost may form at point of restriction and extend down in direction of refrigerant flow in system). Go to step 5.

3. Visually check system for kinks in refrigeration line which is causing restriction. Correct kink and repeat step 2.
 4. Turn unit off and time how long it takes high and low pressure gauges to equalize:
 - If pressure equalization takes longer than 10 minutes, a restriction exists in the capillary tube or drier filter. Go to step 5.
 - If pressure equalization takes less than 10 minutes, system is not restricted. Check for other possible causes of malfunction.
 5. Recover refrigerant in sealed system.
- NOTE:** Before opening any refrigeration system, capture refrigerant in system for safe disposal.
6. Remove power from unit.



CAUTION

To avoid risk of personal injury or property damage, take necessary precautions against high temperatures required for brazing.

7. Remove and replace restricted device.
 8. Evacuate sealed system.
 9. Charge system to specification.
- NOTE:** Do not use captured or recycled refrigerant in units. Captured or recycled refrigerant voids any compressor manufacturer's warranty.
- NOTE:** Charge system with exact amount of refrigerant. Refer to unit nameplate for correct refrigerant charge. Inaccurately charged system will cause future problems.

Service Procedures



WARNING

To avoid risk of electrical shock, personal injury, or death, disconnect electrical power source to unit, unless test procedures require power to be connected. Discharge capacitor through a 10,000 ohm resistor before attempting to service. Ensure all ground wires are connected before certifying unit as repaired and/or operational.

Evacuation and Charging



CAUTION

To avoid risk of fire, sealed refrigeration system must be air free. To avoid risk of air contamination, follow evacuation procedures exactly.

NOTE: Before opening any refrigeration system, EPA regulations require refrigerant in system to be captured for safe disposal.

Proper evacuation of sealed refrigeration system is an important service procedure. Usable life and operational efficiency greatly depends upon how completely air, moisture and other non-condensables are evacuated from sealed system.

Air in sealed system causes high condensing temperature and pressure, resulting in increased power requirements and reduced performance.

Moisture in sealed system chemically reacts with refrigerant and oil to form corrosive hydrofluoric and hydrochloric acids. These acids attack motor windings and parts, causing premature breakdown.

Before opening system, evaporator coil must be at ambient temperature to minimize moisture infiltration into system.

Evacuation

To evacuate sealed refrigeration system:

1. Connect vacuum pump, vacuum tight manifold set with high vacuum hoses, thermocouple vacuum gauge and charging cylinder as shown in illustration. Evacuation should be done through I.D. opening of tubes not through line piercing valve.
2. Connect low side line to compressor process tube.
3. Connect high side line to drier/process tube.
4. Evacuate both simultaneously. With valve "C" and "F" closed, open all other valves and start vacuum pump.

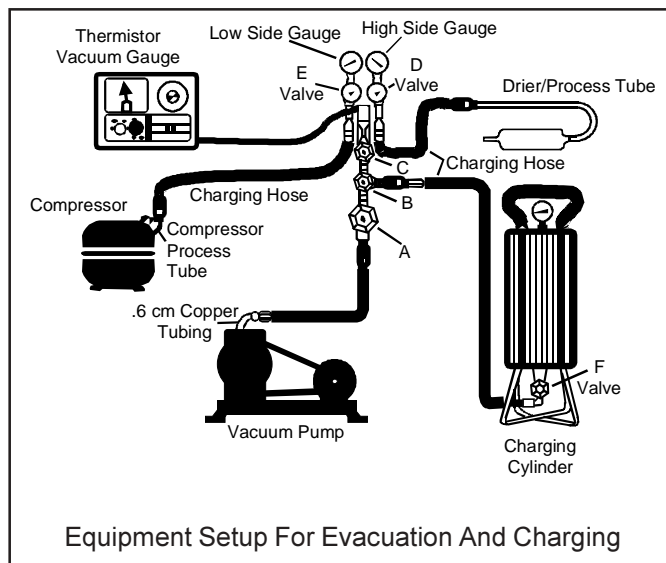

Equipment Setup For Evacuation And Charging

5. After compound gauge (low side) drops to approximately 29 inches gauge, open valve "C" to vacuum thermocouple gauge and take micron reading.

NOTE: A high vacuum pump can only produce a good vacuum if oil in pump is not contaminated.

6. Continue evacuating system until vacuum gauge registers 600 microns.
7. At 600 microns, close valve "A" to vacuum pump and allow micron reading in system to balance. Micron level will rise.
 - If in 2 minutes, micron level stabilizes at 1000 microns or below, system is ready to be charged.
 - If micron level rises above 1000 microns and stabilizes, open valve "A" and continue evacuating.
 - If micron reading rises rapidly and does not stabilize, a leak still exists in system.

Close valve "A" to vacuum pump and valve "C" to vacuum gauge. Invert charging cylinder and open charging cylinder valve "F" to add partial charge for leak checking. With leak detector, check manifold connections and system for leaks. After locating leak, capture refrigerant, repair leak, and begin at step 1.

Service Procedures



WARNING

To avoid risk of electrical shock, personal injury, or death, disconnect electrical power source to unit, unless test procedures require power to be connected. Discharge capacitor through a 10,000 ohm resistor before attempting to service. Ensure all ground wires are connected before certifying unit as repaired and/or operational.

Charging

NOTE: Do not use captured or recycled refrigerant in units. Captured or recycled refrigerant voids any warranty.

NOTE: Charge system with exact amount of refrigerant. Refer to unit serial plate for correct refrigerant charge. Inaccurately charged system will cause future problems.

To charge system:

1. Close valves "A" to vacuum pump and "C" to vacuum gauge and "E" to low side manifold gauge.
2. Set scale on dial-a-charge cylinder for corresponding HFC134a pressure reading.
3. Open valve "F" to charging cylinder and let exact amount of refrigerant flow from cylinder into system. Close valve.
Low side gauge pressure should rise shortly after opening charging cylinder valve as system pressure equalizes through capillary tube.
If pressure does not equalize, a restriction typically exists at capillary/drier braze joint.
4. If pressure equalizes, open valve "E" to low side manifold gauge and pinch off high side drier process tube.
5. Start compressor and draw remaining refrigerant from charging hoses and manifold into compressor through compressor process tube.
6. To check high side pinch-off drier process tube. Close valve "D" to high side gauge. If high side pressure rises, repeat high side pinch-off and open valve "D". Repeat until high side pinch-off does not leak.
7. Pinch-off compressor process tube and remove charging hose. Braze stub closed while compressor is operating.
8. Disconnect power. Remove charging hose and braze high side drier process tube closed.
9. Recheck for refrigerant leaks.

Refrigerant Charge

Refrigerant charge in all capillary tube systems is critical and exact amount is required for proper performance. Factory charges are shown on serial plate.

NOTE: Do not use refrigerant other than shown on serial plate.

Service Procedures



WARNING

To avoid risk of electrical shock, personal injury, or death, disconnect electrical power source to unit, unless test procedures require power to be connected. Discharge capacitor through a 10,000 ohm resistor before attempting to service. Ensure all ground wires are connected before certifying unit as repaired and/or operational.

HFC134a Service Information

HFC134a is alternative refrigerant for CFC12. HFC134a has an ozone depletion potential (ODP) factor of 0.0 and a global warming potential (GWP) factor of 0.27. HFC134a is not flammable and has acceptable toxicity levels. HFC134a is not interchangeable with CFC12. There are significant differences between HFC134a and CFC12 which must be considered when handling and processing refrigeration system.

Health, Safety, and Handling

Health, safety and handling considerations for HFC134A are virtually no different than those for CFC12.

Health, Safety, and Handling	CFC12	HFC134a
Allowable overall exposure limit	1,000 ppm	Same
Vapor exposure to skin	No effect	Same
Liquid exposure to skin	Can cause frostbite	Same
Vapor exposure to eye	Very slight eye irritant	Same
Liquid exposure to eye	Can cause frostbite	Same
Above minimum exposure limit	Can cause Asphyxiation, Tachycardia, and Cardia Arrhythmias	Same
Safety and handling	Wear appropriate skin and eye protection. Use with adequate ventilation.	Same
Spill management	Remove or extinguish ignition or combustion sources. Evacuate or ventilate area.	Same
Fire explosion hazards	May decompose if contact with flames and heating elements. Container may explode if heated due to resulting pressure rise. Combustion products are toxic.	Same
Disposal procedures	Recycle or reclaim.	Same

Comparison of CFC12 and HFC134a Properties

Properties/Characteristics	CFC12	HFC134a
Ozone Depletion Potential (ODP)	1.0*	0.0*
Global Warming Potential (GPW)	3.2*	0.27*
Molecular weight	121	102
Boiling point at 1 atmosphere	-22°F (-30°C)	-15°F (-126°C)
Vapor pressure at 77°F (25°C)	80 psig	82 psig
Liquid density at 77°F (25°C)	82 lb/ft ³	75 lb/ft ³
Flammability	No	No
High-side system operating Pressure at 65°F (18°C)	HFC134a approximately 3 psig higher than CFC12	
Low-side system operating Pressure at 65°F (18°C)	HFC134a approximately 2 psig lower than CFC12	



CAUTION

To minimize contamination, exercise extreme care when servicing HFC134A sealed systems.

- No trace of other refrigerants is allowed in HFC134a systems. Chlorinated molecules in other refrigerants such as CFC12, etc. will lead to capillary tube plugging.
- Ester oil is used in HFC134a systems. Do not use mineral oil. HFC134a and mineral oils cannot be mixed. If mineral oils were used in HFC134a systems, lubricant would not return to compressor and would cause early compressor failure. If significant amount of oil has been lost from compressor, replace oil rather than adding oil.
- Ester oils used in HFC134a systems are so hydroscopic that by the time an inadequate system performance is detected, oil will be saturated with moisture.
- CFC12 has much higher tolerance to system processing materials, such as drawing compounds, rust inhibitors, and cleaning compounds, than HFC134a. Such materials are not soluble in HFC134a systems. If materials were to be washed from system surfaces by ester oils, they could accumulate and eventually plug capillary tube.
- Care must be taken to minimize moisture entering HFC134a system. Do not leave compressor or system open to atmosphere for more than 10 minutes. Excessive moisture in HFC134a system will react with compressor oil and generate acid.
- Compressor must be replaced when performing low side leak repair.
- Drier filter must always be replaced with service drier filter, part #B2150504.

Important: Unbrazing drier filter from tubing will drive moisture from desiccant and into system, causing acids to form. Do not unbraid filter drier from tubing. If CFC12 service drier was installed in HFC134A system, drier could overload due to excessive moisture.

- HFC134a compatible copper tubing, part #R0174075 (1/4" O.D. X 18" length) and part #R0174076 (5/16" O.D. X 24" length) must be used when replacing tubing.
- Avoid system contamination by using Towerdraw E610 evaporating oil, part # R0157532, when flaring, swagging, or cutting refrigeration tubing.

Service Procedures



WARNING

To avoid risk of electrical shock, personal injury, or death, disconnect electrical power source to unit, unless test procedures require power to be connected. Discharge capacitor through a 10,000 ohm resistor before attempting to service. Ensure all ground wires are connected before certifying unit as repaired and/or operational.

Replacement Service Compressor

HFC134a service compressors will be charged with ester oil and pressurized with dry nitrogen. Before replacement compressor is installed, pull out 1 rubber plug. A *pop* from pressure release should be heard. If a *pop* sound is not heard, do not use compressor. Positive pressure in compressor is vital to keep moisture out of ester oil. Do not leave compressor open to atmosphere for more than 10 minutes.

Compressor Testing Procedures



WARNING

To avoid death or severe personal injury, never use oxygen, air or acetylene for pressure testing or clean out of refrigeration system. Use of oxygen, air, or acetylene may result in violent explosion. Oxygen may explode on contact with oil and acetylene will spontaneously explode when under pressure.

Refer to Technical Data Sheet "Temperature Relationship Chart" for operating watts, test points, and temperature relationship test for unit being tested.

- Temperature testing is accomplished by using 3 lead thermocouple temperature tester in specific locations. Test point T-1 is outlet on evaporator coil and T-2 is inlet. Test point T-3 is suction tube temperature midway between where armaflex ends and suction port of compressor (approximately 12 inches from compressor).
- Thermocouple tips should be attached securely to specified locations.
- Do not test during initial *pull down*. Allow one off cycle or balanced temperature condition to occur before proceeding with testing.
- Refrigerator must operate minimum of 20 minutes after thermocouples are installed.
- Turn control to colder to obtain required on time.
- Wattage reading must be recorded in conjunction with temperature test to confirm proper operation.
- Suction and head pressures are listed on "Temperature and Relationship Chart". Normally these are not required for diagnosis but used for confirmation on systems which have been opened.

Brazing



CAUTION

To avoid risk of personal injury or property damage, take necessary precautions against high temperatures required for brazing.

Satisfactory results require cleanliness, experience, and use of proper materials and equipment.

Connections to be brazed must be properly sized, free of rough edges, and clean.

Generally accepted brazing materials are:

- **Copper to copper joints:** SIL-FOS (alloy of 15 percent silver, 80 percent copper, and 5 percent phosphorous). Use without flux. Recommended brazing temperature is approximately 1400°F. **Do not use for copper to steel connection.**
- **Copper to steel joints:** SILVER SOLDER (alloy of 30 percent silver, 38 percent copper, 32 percent zinc). Use with fluoride based flux. Recommended brazing temperature is approximately 1200°F.
- **Steel to steel joints:** SILVER SOLDER (see copper to steel joints).
- **Brass to copper joints:** SILVER SOLDER (see copper to steel joints).
- **Brass to steel joints:** SILVER SOLDER (see copper to steel joints).

Refrigerant Flow

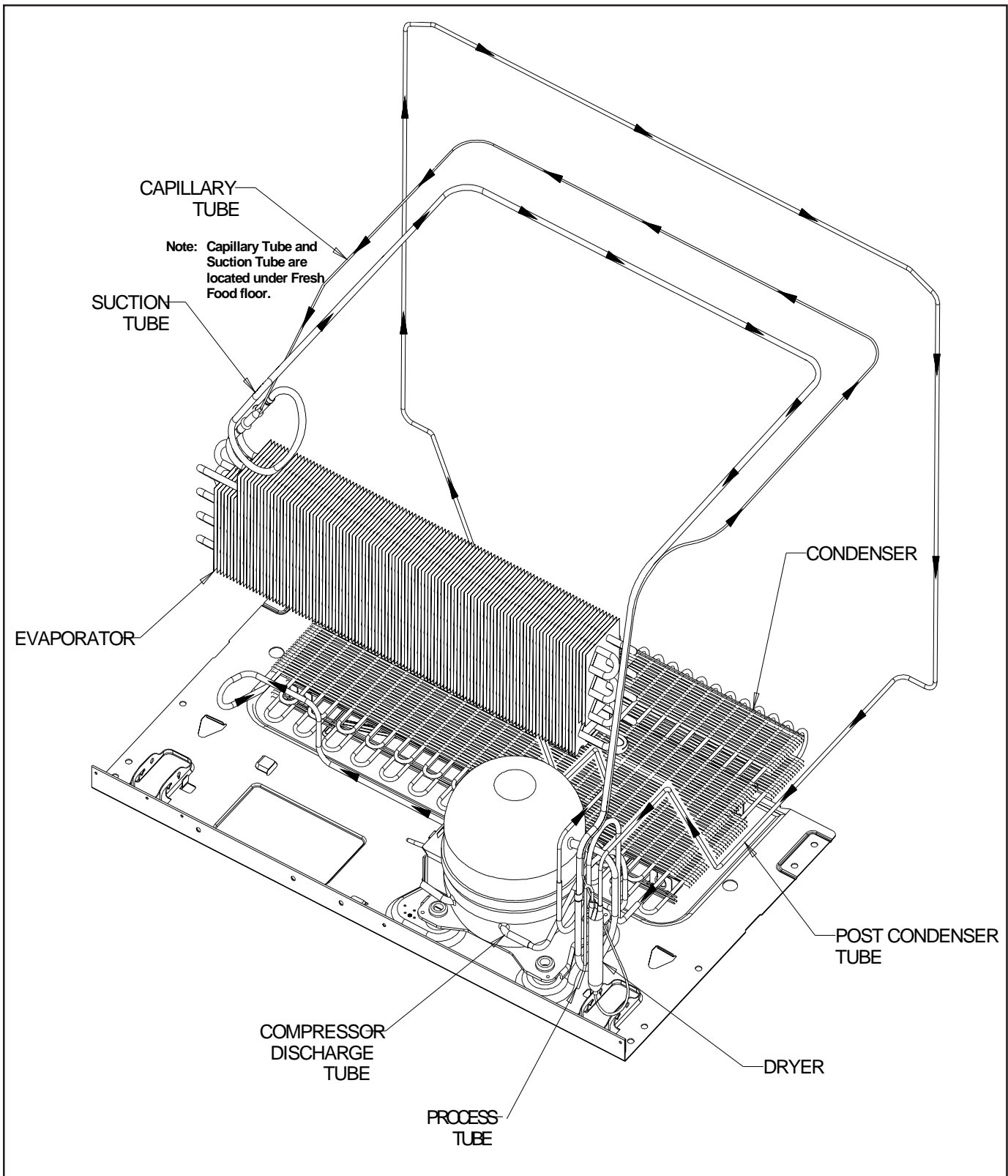

19, 20, 22 cu. ft. Bottom Mount Refrigerant Flow Diagram

Cabinet Air Flow

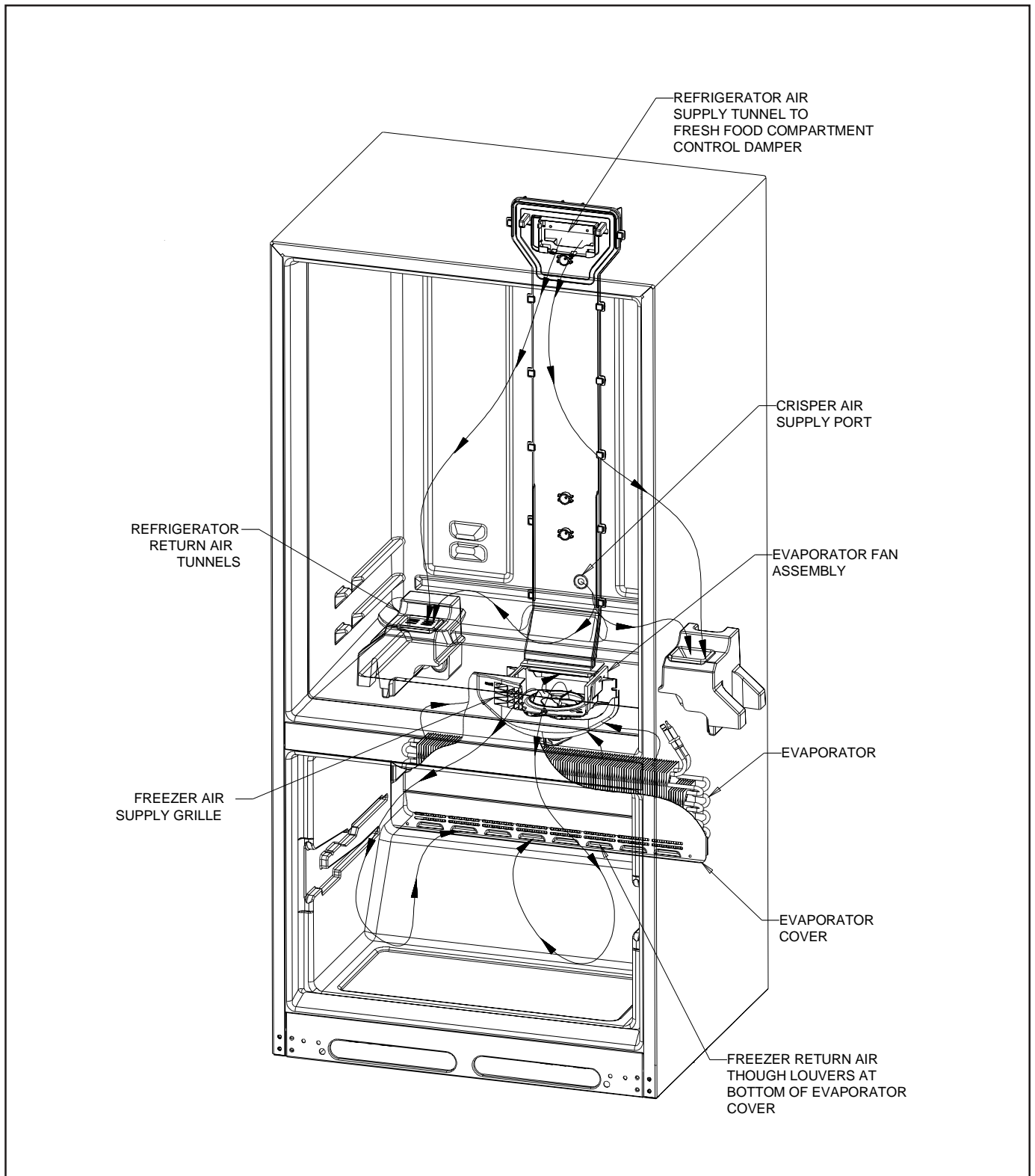

**19, 20, 22 cu. ft. Bottom Mount
Cabinet Air Flow Diagram**

Machine Compartment Air Flow

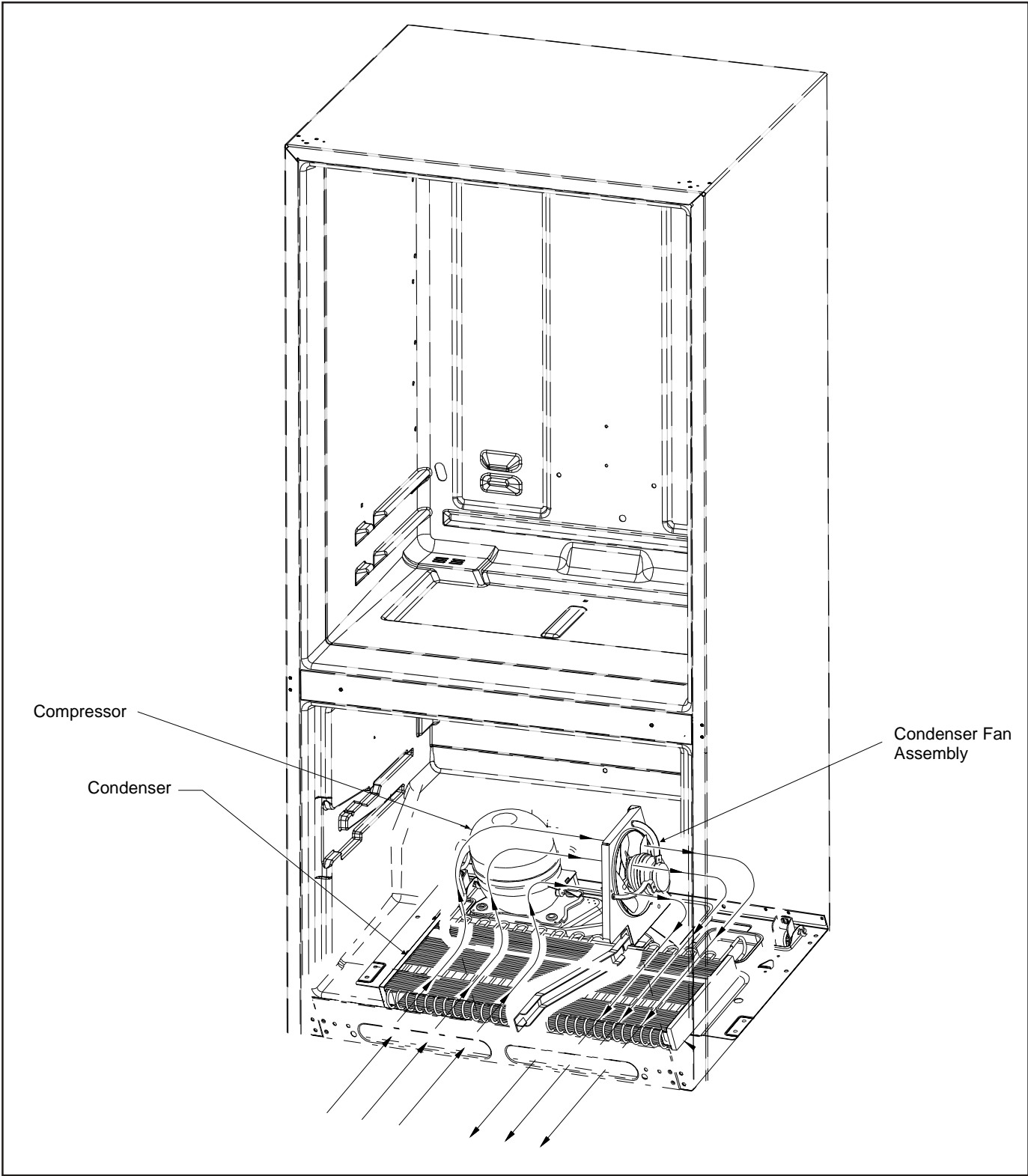

**20 cu. ft. Bottom Mount
Machine Compartment Air Flow Diagram**

Machine Compartment Air Flow

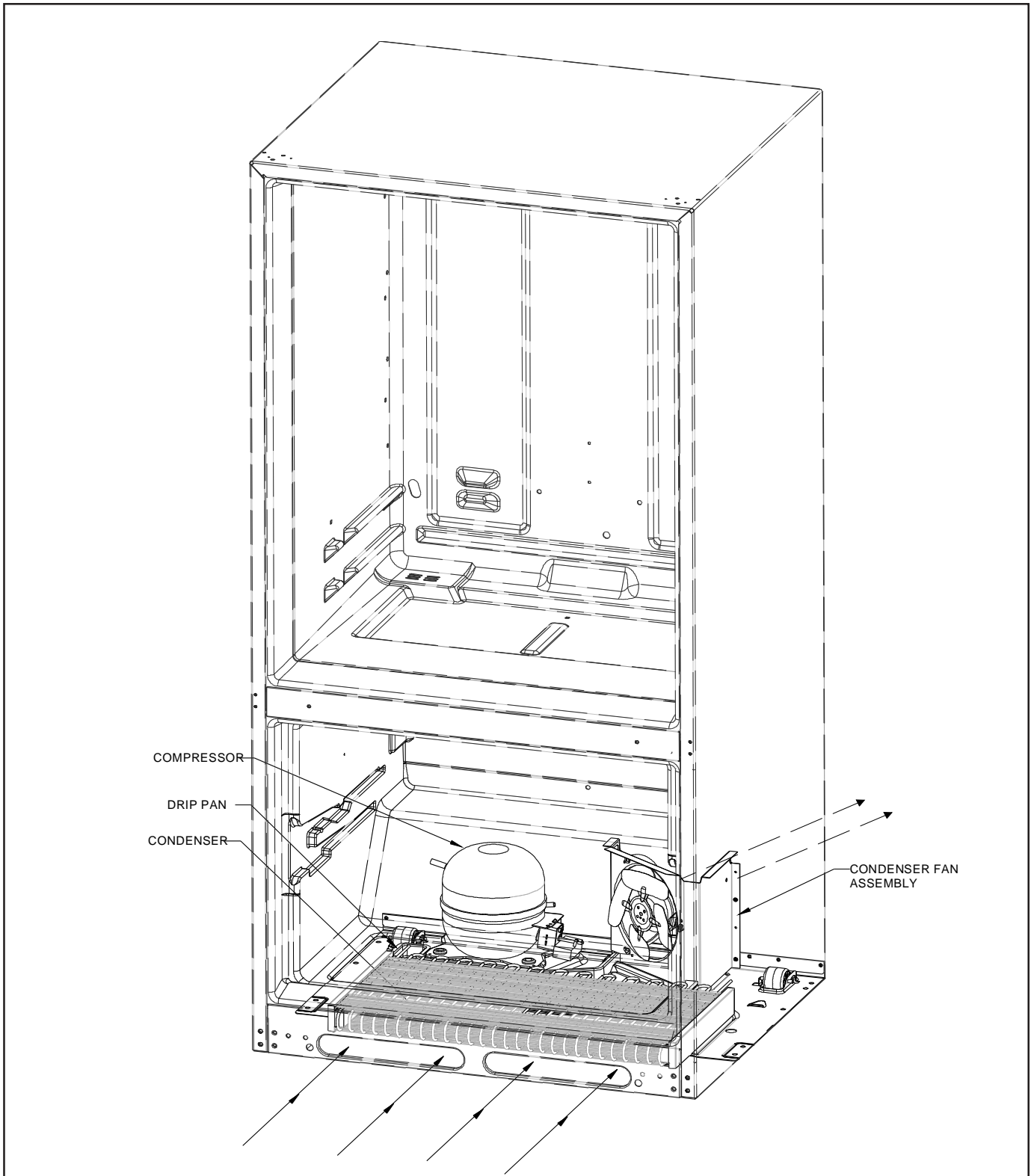

**19, 22 cu. ft. Model Bottom Mount
Machine Compartment Air Flow Diagram**

Water Dispenser

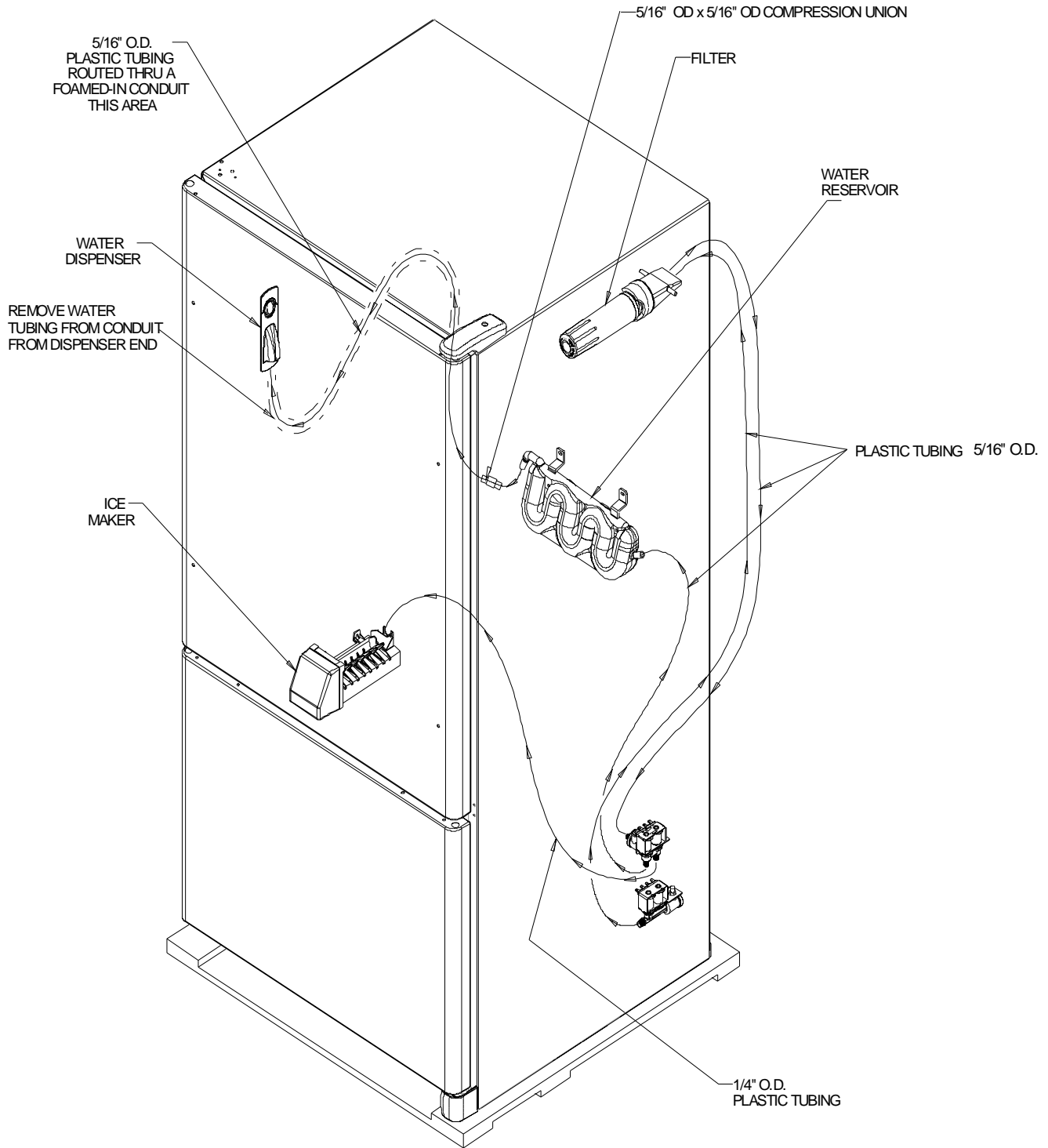

WATER DISPENSING FLOW

Typical External Sweat Pattern

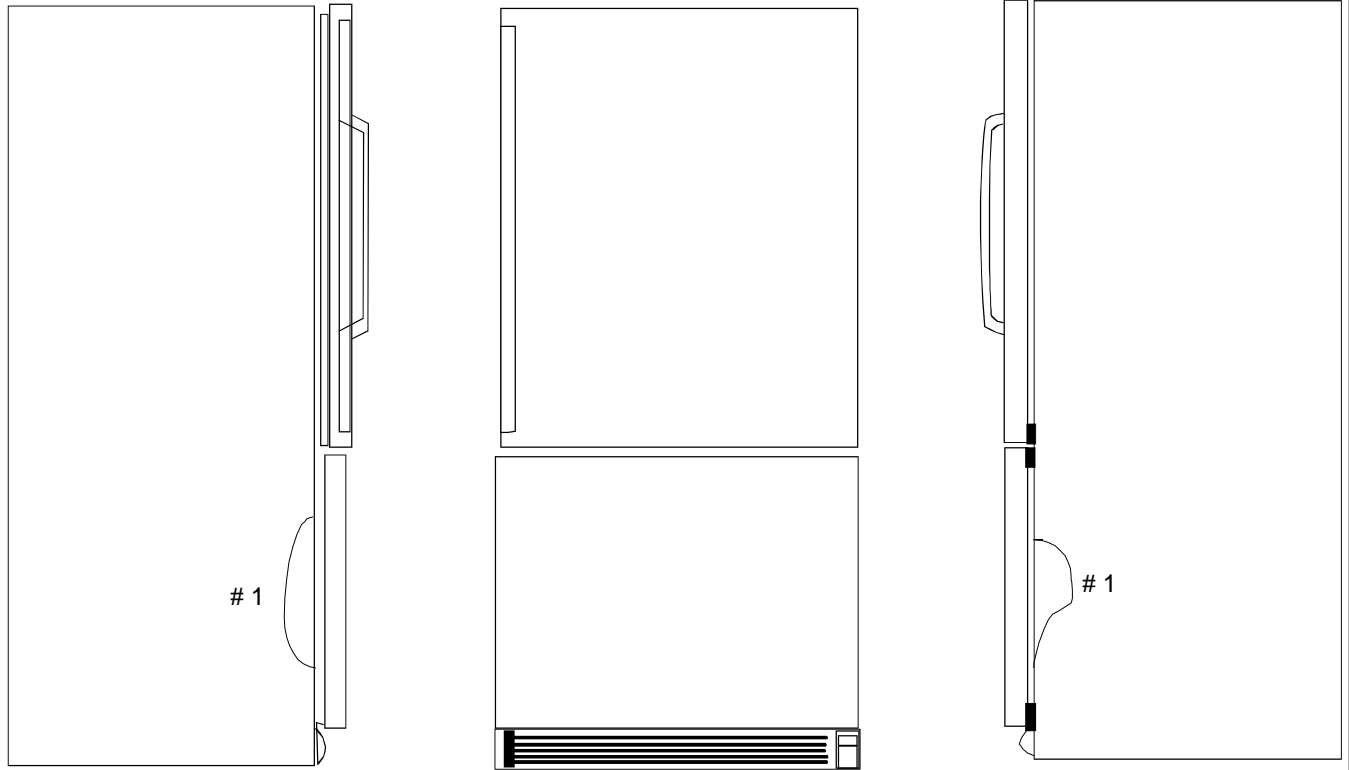

CLASSIFICATION OF CONDENSATION

- 1 = Haze or fog
- 2 = Beading
- 3 = Beads or small drops
- 4 = Drops running together

Conditions after 4 hour
Laboratory Sweat Test.
Ambient: 90 dF
Relative humidity 84%
Refrigerator Temp. 40 dF
Freezer Temp. 0 dF

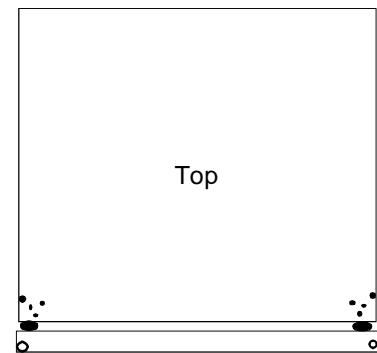
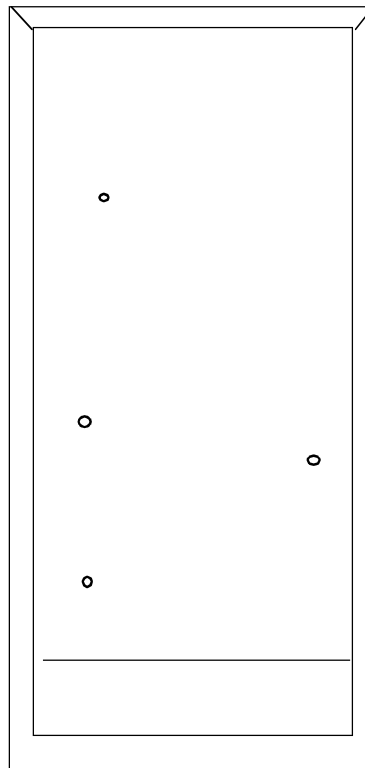

Refrigerator door bottom

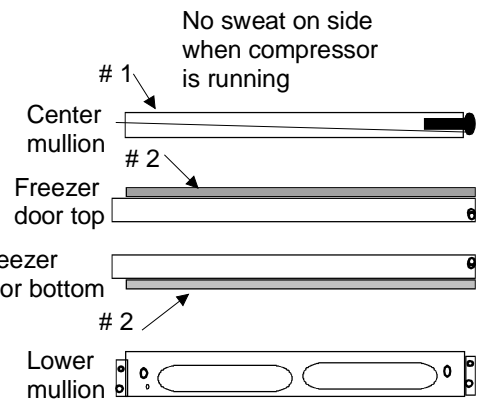

Troubleshooting Chart



WARNING

To avoid risk of electrical shock, personal injury, or death, disconnect electrical power source to unit, unless test procedures require power to be connected. Discharge capacitor through a resistor before attempting to service. Ensure all ground wires are connected before certifying unit as repaired and/or operational.

Troubleshooting chart on following pages contains symptoms that may be seen in malfunctioning units. Each symptom is accompanied by one or more possible causes and by a possible remedy or test to determine if components are working properly.

Symptom	Possible Causes	Corrective Action
Unit does not run	No power to unit	Check for power at outlet. Check fuse box/circuit breaker for blown fuse or tripped breaker. Replace or reset.
	Faulty power cord	Check with test light at unit; if no circuit and current is indicated at outlet, replace or repair.
	Low voltage	Check input voltage for proper voltage. Take appropriate action to correct voltage supply problem.
	Faulty motor or freezer temperature control	Check all connections are tight and secure. Jumper across terminals of control. If unit runs, replace control.
	Faulty timer	Check with test light. Replace if necessary.
	Faulty relay	Check relay. Replace if necessary.
	Faulty compressor	Check compressor motor windings for opens/shorts. Perform compressor direct wiring test. Replace if necessary.
	Faulty overload	Check overload for continuity. NOTE: Ensure compressor/overload are below trip temperature before testing. Replace if necessary.
Refrigerator section too warm	Excessive door opening	Consumer education
	Overloading of shelves	Consumer education
	Warm or hot foods placed in cabinet	Consumer education
	Cold control set too warm	Set control to colder setting.
	Poor door seal	Level cabinet. Adjust hinges. Replace gasket.
	Refrigerator airflow	Check damper is opening by removing grille. With door open, damper should open. Replace if faulty. Turn control knob to colder position.
	Interior light remains on	Check switch. Replace if necessary.
	Faulty condenser fan or evaporator fan	Check fan and wiring. Replace if necessary.
	Faulty compressor	Replace compressor.

Troubleshooting Chart



WARNING

To avoid risk of electrical shock, personal injury, or death, disconnect electrical power source to unit, unless test procedures require power to be connected. Discharge capacitor through a resistor before attempting to service. Ensure all ground wires are connected before certifying unit as repaired and/or operational.

Symptom	Possible Causes	Corrective Action
Refrigerator section too cold	Refrigerator temperature control set too cold	Adjust refrigerator temperature control.
	Refrigerator airflow not properly adjusted	Check air flow.
Freezer and refrigerator sections too warm	Temperature controls set too warm	Reset temperature controls.
	Poor door seal	Level cabinet. Adjust hinges. Replace gasket.
	Dirty condenser or obstructed grille	Check condenser and grille. Clean.
	Faulty control	Test control. Replace if failed.
	Refrigerant shortage or restriction	Check for leak or restriction. Repair, evacuate and recharge system.
Freezer section too cold	Freezer temp control set too cold	Adjust freezer temperature control.
	Faulty control	Test control. Replace if failed.
	Cold control capillary not properly clamped to evaporator	Reposition clamp and tighten.
Unit runs continuously	Temperature control set too cold	Adjust temperature control.
	Dirty condenser or obstructed grille	Check condenser and grille. Clean.
	Poor door seal	Level cabinet. Adjust hinges. Replace gasket.
	Interior light remains on	Check switch. Replace if necessary.
	Faulty condenser fan or evaporator fan	Check fan and wiring. Replace if necessary.
	Faulty control	Test control. Replace if failed.
	Refrigerant shortage or restriction	Check for leak or restriction. Repair, evacuate and recharge system.
	Refrigerant overcharge	Check for overcharge. Evacuate and recharge system.
	Air in system	Check for low side leak. Repair, evacuate and recharge system.
Unit runs continuously. Temperature normal.	Ice on evaporator	See "Ice on evaporator".
Unit runs continuously. Temperature too cold.	Faulty defrost thermostat	Check thermostat. Replace if necessary.
Noisy operation	Loose flooring or floor not firm	Repair floor or brace floor.
	Cabinet not level	Level cabinet.
	Tubing in contact with cabinet, other tubing, or other metal	Adjust tubing.
	Drip pan vibrating	Adjust drain pan.
	Fan hitting another part	Ensure fan properly aligned and all attaching hardware and brackets are tight and not worn. Tighten or replace.
	Worn fan motor bearings	Check motor for loss of lubricant or worn bearings. Replace if necessary.
	Compressor mounting grommets worn or missing. Mounting hardware loose or missing	Tighten hardware. Replace grommets if necessary.
	Free or loose parts causing or allowing noise during operation	Inspect unit for parts that may have worked free or loose or missing screws. Repair as required.

Troubleshooting Chart



WARNING

To avoid risk of electrical shock, personal injury, or death, disconnect electrical power source to unit, unless test procedures require power to be connected. Discharge capacitor through a resistor before attempting to service. Ensure all ground wires are connected before certifying unit as repaired and/or operational.

Symptom	Possible Causes	Corrective Action
Frost or ice on evaporator	Defrost thermostat faulty	Check defrost thermostat. Replace if failed.
	Evaporator fan faulty	Check fan motor. Replace if failed.
	Defrost heater remains open	Check defrost heater continuity. Replace if failed.
	Defrost control faulty	Check control and replace if failed.
	Open wire or connector	Check wiring and connections. Repair as necessary.
	Refrigerant shortage or restriction	Check for leak or restriction. Repair, evacuate and recharge system.
Unit starts and stops frequently (cycles on and off)	Loose wire or thermostat connections	Check wiring and connections. Repair as necessary.
	Supply voltage out of specification	Check input voltage. Correct any supply problems.
	Overload protector open	Check overload protector for continuity. If open, replace overload. NOTE: Ensure overload/compressor are below trip temperature before testing.
	Faulty compressor motor capacitor (some compressors do not require motor capacitor)	Check capacitor for open/short. Replace if necessary. NOTE: Discharge capacitor before testing.
	Faulty fan motor	Check fan motor. Replace if failed.
	Restricted air flow	Check condenser and grille for dirt. Clean.
	Refrigerant shortage or restriction	Check for leak or restriction. Repair, evacuate and recharge system.

System Diagnosis

CONDITION	SUCTION PRESSURE VARIATION FROM NORMAL	HEAD PRESSURE VARIATION FROM NORMAL	T1 INLET TEMPERATURE VARIATION FROM NORMAL	T2 OUTLET TEMPERATURE VARIATION FROM NORMAL	T3 SUCTION TEMPERATURE VARIATION FROM NORMAL	WATTAGE VARIATION FROM NORMAL
Refrigerant Overcharge	Increase	Increase	Warmer	Warmer	Colder	Increase
Shortage of Refrigerant	Decrease	Decrease or Increase See Text	Colder	Warmer	Warmer	Decrease
Partial Restriction	Decrease	Decrease or Increase See Text Note 2	Colder	Warmer	Warmer	Decrease
Air in System	Near Normal	Increase	Warmer	Warmer	Warmer	Increase
Low Ambient Installations (High Ambients the Reverse)	Decrease	Decrease	Colder	Warmer	Warmer	Decrease
Additional Heat Load	Increase	Increase	Warmer	Warmer	Warmer	Increase
Inefficient Compressor	Increase	Normal or Decrease	Warmer or Colder	Warmer	Warmer	Decrease

Symptoms of an Overcharge

- Above normal freezer temperatures.
- Longer than normal or continuous run.
- Freezing in refrigerator.
- Higher than normal suction and head pressure.
- Higher than normal wattage.
- Evaporator inlet and outlet temperatures warmer than normal.
- Suction tube temperature below ambient. Always check for separated heat exchanger when suction temperature is colder than ambient.

Various conditons could indicate an overcharge. For example, if the cooling coil is not defrosted at regular intervals, due to a failure of the defrost system, the refrigerant will "flood out" and cause the suction line to frost or sweat. The cause of this problem should be corrected rather than to purge refrigerant from the sytem. Running the freezer section colder than necessary (-2 to -1 F. is considered normal package temperatures) or continuous running of the compressor for a variety of reasons, or the freezer fan motor not running, may give the indication of an overcharge.

Symptoms of Refrigeration Shortage

- Rise in food product temperature in both compartments. (See Note 1 below.)
- Long or continuous run time.
- Look for obvious traces of oil that would occur due to a leak or cracked refrigerant line.
- Lower than normal wattage.
- Compressor will be hot to touch because of the heat generated by the motor windings from long continuous running. It will not be as hot as it would be with a full charge and long run times for some other reason such as a dirty condenser.
- Depending on the amount of the shortage, the condenser will not be hot, but closer to room temperature. The capillary tube will be warmer than normal from a slight shortage.
- If the leak is on the high side of the system, both gauges will show lower than normal readings and will show progressively lower readings as this charge becomes less. The suction pressure guage will probably indicate a vacuum.
- If the leak is on the low side of the system the suction pressure guage will be lower than normal - probably in a vacuum - and the head pressure gauge will be higher than normal. It will probably continue to become higher because air drawn in through the leak is compressed by the compressor and accumulates in

System Diagnosis

the high side (condenser) of the system.

- Only partial frosting of evaporator instead of even frosting of entire coil.

NOTE 1: Usually the first thing that is noticed by the user is a rise in temperature foods. Although temperatures will rise in both the freezer section and the food compartment, the frozen meats and vegetables will not thaw immediately. The customer doesn't associate the problem with the freezer section and will first notice that milk and other food beverages are not cold enough.

Under some circumstances, such as in the case of forced air meatkeeper model with a slight shortage of refrigerant, freezing in the food compartment may be experienced due to the additional running time. With a refrigerant leak, however, it always gets worse and as the refrigerant charge decreases the temperature will continue to rise.

With a shortage of refrigerant the capillary line will not have a full column of liquid. As a result, there is a noticeable hissing sound in the evaporator. This should not be mistaken for the regular refrigerant boiling sounds that would be considered normal.

Symptoms of a Restriction

Always remember refrigeration (cooling) occurs on the low pressure side of a partial restriction (obviously a total restriction will completely stop the circulation of refrigerant and no cooling will take place).

Physically feel the refrigeration lines when a restriction is suspected. The most common place for a restriction is at the drier-filter or at the capillary tube inlet or outlet. If the restriction is not total there will be a temperature difference at the point of restriction, the area on the evaporator side will be cooler. In many cases frost and/or condensation will be present. A longer time is required for the system to equalize.

Any kinked line will cause a restriction so the entire system should be visually checked.

A slight restriction will give the same indications as a refrigerant shortage with lower than normal back pressure, head pressure, and wattage, warmer product temperatures.

NOTE 2: If a total restriction is on the discharge side of the compressor, higher than normal head pressures and wattages would result. This is true only while the low side is being pumped out and if the restriction was between the compressor and the first half of the condenser.

To diagnose for a restriction versus a refrigerant shortage, discharge the system, replace the drier-filter, evacuate and recharge with the specified refrigerant charge. If the unit performs normally three possibilities exist: 1) refrigerant loss, 2) partially restricted drier-filter, and 3) moisture in system.

If the unit performs as it previously did you may have a restricted capillary line or condenser or kinked line. Find the point of restriction and correct it.

A restriction reduces the flow rate of the refrigerant and consequently reduces the rate of heat removal. Complete restriction may be caused by moisture, solid contaminants in the system, or a poorly soldered joint. Moisture freezes at the evaporator inlet end of the capillary tube or solid contaminants collect in the drier-filter. The wattage drops because the compressor is not circulating the usual amount of refrigerant.

As far as pressure readings are concerned, if the restriction, such as a kinked line or a joint soldered shut is anywhere on the low side, the suction pressure would probably be in a vacuum while the head pressure will be near normal. If the restriction is on the high side, the suction pressure, again, will probably be in a vacuum while the head pressure will be higher than normal during the pump out period described earlier. In either case, it will take longer than the normal ten minutes or so for the head pressure to equalize with the low side after the compressor stops.

Symptoms of Air in System

This can result from a low side leak or improper servicing. If a leak should occur on the low side, the temperature control would not be satisfied; thus, continuous running of the compressor would result. The compressor would eventually pump the low side into a vacuum drawing air and moisture into the system. Air and R134A do not mix so the air pressure would be added to the normal head pressure, resulting in higher than normal head pressures.

One way to determine if air is in the system is to read the head pressure gauge with the product off and evaporator and condenser at the same temperature and then take the temperature on the condenser outlet tube. This temperature should be within 3° or 4° F. of what the Pressure-Temperature Relation chart shows for the given idle head pressure. If the temperature of the condenser outlet is considerably lower than the idle head pressure of the gauge this would indicate there is air in the system.

Thorough leak checking is necessary. Correct the source of the leak. Do not attempt to purge off the air because this could result in the system being undercharged. It is best to discharge, replace drier, evacuate and recharge with the specified refrigerant charge.

System Diagnosis

Symptoms of Low or High Ambient Temperature Installation

Lower ambient air temperature reduces the condensing temperature and therefore reduces the temperature of the liquid entering the evaporator. The increase in refrigeration effect due to operation in a lower ambient results in a decrease in power consumption and run time. At lower ambients there is a reduction in cabinet heat leak which is partially responsible for lower power consumption and run time.

An increase in refrigeration effect cannot be expected below a certain minimum ambient temperature. This temperature varies with the type and design of the product.

Generally speaking, ambient temperatures cannot be lower than 60° F. without affecting operating efficiency. Conversely, the higher the ambient temperature the higher the head pressure must be to raise the high side refrigerant temperature above that of the condensing medium. Therefore, head pressure will be higher as the ambient temperature raises. Refrigerators installed in ambient temperatures lower than 60° F. will not perform as well because the pressures within the system are generally reduced and unbalanced. This means that the lower head pressure forces less liquid refrigerant through the capillary line. The result is the symptoms of a refrigerant shortage. The lower the ambient temperature the more pronounced this condition becomes.

When a point where the ambient temperature is below the cut-in of the Temperature Control is reached, the compressor won't run.

The drain traps will freeze in ambient temperatures of 32° F.

Heat Load

A greater heat load can result from the addition of more than normal supply of foods, such as after doing the weekly shopping. Other items contributing to an additional heat load would be excessive door openings, poor door sealing, interior light remaining on, etc.

An increase in heat being absorbed by the refrigerant in the evaporator will affect the temperature and pressure of the gas returning to the compressor. Compartment temperatures, power consumption, discharge, and suction pressures are all affected by heat load.

Pressures will be higher than normal under heavy heat load.

Disassembly Procedures



WARNING

To avoid risk of electrical shock, personal injury, or death, disconnect electrical power source to unit, unless test procedures require power to be connected. Discharge capacitor through a resistor before attempting to service. Ensure all ground wires are connected before certifying unit as repaired and/or operational.

Door Removal

Fresh Food Door

1. Open both compartment doors. Remove door buckets, all shelving and drawers from refrigerator and freezer compartments. Place components on a padded surface to avoid damage.
2. Close both doors and tape them shut so they won't fall off unexpectedly when hinges are removed.

NOTE: To minimize possibility of personal injury and/or property damage, make sure unit doors are taped shut before you undertake the next steps:

3. On top of unit, remove screw and retain plastic cap from door hinge.
4. Remove and retain screws from top door hinge.
5. Pull tape off of door and lift door off unit. Set door on a padded surface to prevent damage to finish.
6. Remove and retain center hinge pin and all plastic shims. Note number and location of shims as you do so.

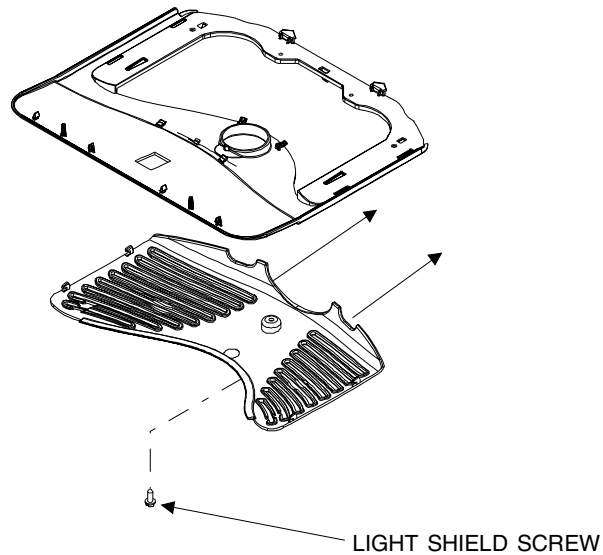

Freezer Door (some models)

1. Pull tape off freezer door and lift door off unit. Set door on a padded surface to prevent damage to finish.
2. If clearance requirements so dictate, remove center and lower door hinges:
 - a. Remove screws from center hinge bracket. Remove and retain bracket, screws, and all shims.
 - b. Remove toe grille by pulling it directly away from unit, and pop plastic cover off bottom door hinge. Grille and cover are fragile: keep both parts safe from harm.
 - c. Remove bottom hinge pin and all shims from bottom hinge bracket. Note number and location of shims. Retain all parts.
 - d. Loosen mounting screws from bottom hinge bracket. Remove and retain bracket and bolts.

Freezer Drawer (some models)

1. Open drawer to fully open position.
2. Remove upper and lower basket.
3. Remove screws one in each rail marked on side of rail.
4. Lift front of drawer up and out to remove drawer.
5. Set drawer on a padded surface to prevent damage to finish.

Refrigerator Compartment

Light Bulb

1. Loosen mounting screw from refrigerator light cover. Remove screw and slide cover to the rear to release it from holding tabs. Retain all parts.

Light Bulb Assembly

1. Loosen mounting screw from refrigerator light cover. Remove screw and slide cover to the rear to release it from holding tabs. Retain all parts.
2. Remove light bulbs.
3. Remove damper control cover and foam insert by pulling straight on sides of rear cover and tilt forward 1/2" to 1". This will release the cover from the tabs holding it in place.
4. Release tension on damper control belt by squeezing tabs on bottom of belt tensioner to release tensioner from its holding tabs.
5. Slip belt off of damper control cog.
6. Use a taped putty knife to carefully pry front edge of light assembly plastic housing. This releases tabs holding up front of housing.
7. When released disconnect connector plugged in to cabinet liner.

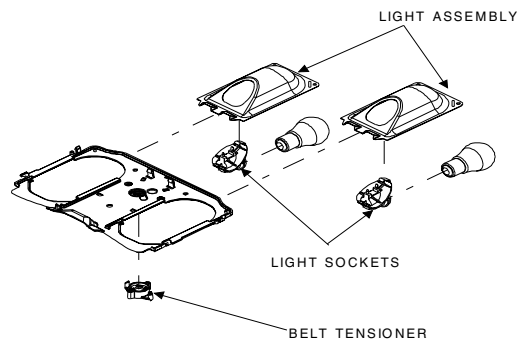

Disassembly Procedures



WARNING

To avoid risk of electrical shock, personal injury, or death, disconnect electrical power source to unit, unless test procedures require power to be connected. Discharge capacitor through a resistor before attempting to service. Ensure all ground wires are connected before certifying unit as repaired and/or operational.

Light Bulb Sockets

1. After following procedure on removing light bulb assembly.
2. Disconnect wires to sockets.
3. Squeeze tab on back side of socket to release it from assembly.
4. Reverse procedure to reassemble.

Defrost Timer

1. After following procedure on removing light bulb assembly.
2. Remove hex head screws holding timer to assembly.
3. Disconnect plug from timer.
4. Reverse procedure to reassemble.

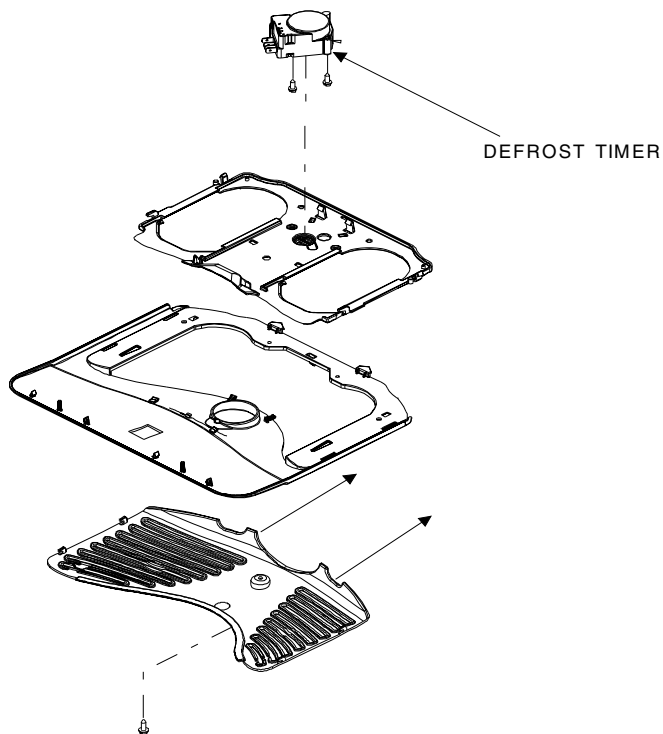

Light Switch

1. After following procedure on removing light bulb assembly.
2. Disconnect wires from light switch.
3. Squeeze tab to release light switch from light assembly.
4. Reverse procedure to reassemble.

Temp-Assure™ Damper Control

1. Remove light shield.
2. Remove damper control cover and foam insert by pulling straight on sides of rear cover and tilt forward 1/2" to 1". This will release the cover from the tabs holding it in place.
3. Release tension on damper control belt by squeezing tabs on bottom of belt tensioner to release tensioner from it's holding tabs.
4. Slip belt off of damper control cog.
5. Damper can be removed by pushing in tabs on left and right side of damper control to release damper from rear wall.
6. Reverse procedure to reassemble.

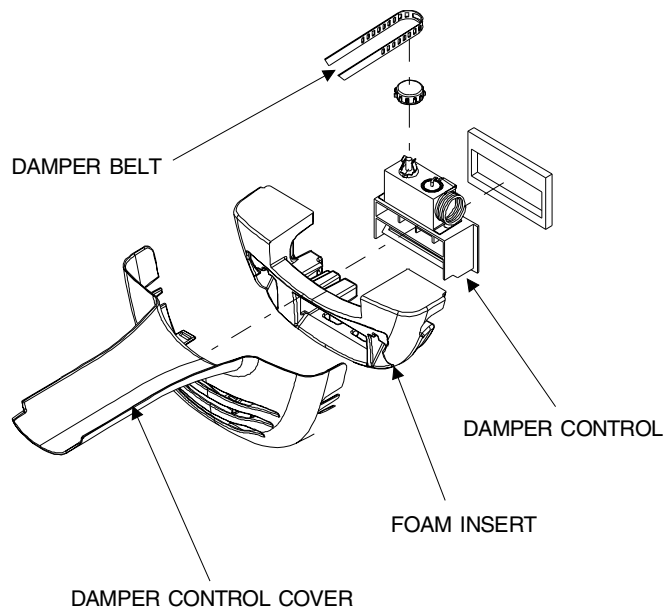

Water Tank (some models)

1. Turn water off to unit.
2. Disconnect water line that supplies water tank from water valve.
3. Remove compression nut off of inlet to tank.
4. Remove crispers from fresh food compartment.
5. Disconnect compression nut from union on outlet of tank.
6. Remove two hex head screws holding tank to rear bulkhead.
7. Remove water tank and tubing.
8. Reverse procedure to reassemble.

Disassembly Procedures



WARNING

To avoid risk of electrical shock, personal injury, or death, disconnect electrical power source to unit, unless test procedures require power to be connected. Discharge capacitor through a resistor before attempting to service. Ensure all ground wires are connected before certifying unit as repaired and/or operational.

Water Dispenser (some models)

1. Turn water off to unit.
2. Remove crispers from fresh food compartment.
3. Carefully pry top cover of dispenser out and remove.
4. Remove hex head screw to release dispenser from cabinet.
5. Disconnect compression nut from union at outlet of tank.
6. Remove compression nut from tubing.
7. Pull dispenser assembly and tube out of side wall.
8. Reverse procedure to reassemble.

Freezer Compartment

Freezer Temperature Control

1. Remove screw from rear edge of light shield.
2. Squeeze lens to release lens cover and remove.
3. With flat blade screwdriver release tabs in front of cold control knob.
4. Cold control assembly will drop down when released.
5. Remove Knob by pulling off shaft.
6. Disconnect wires from cold control.
7. Release cold control capillary from retainers.
8. Squeeze tab to release cold control from assembly.

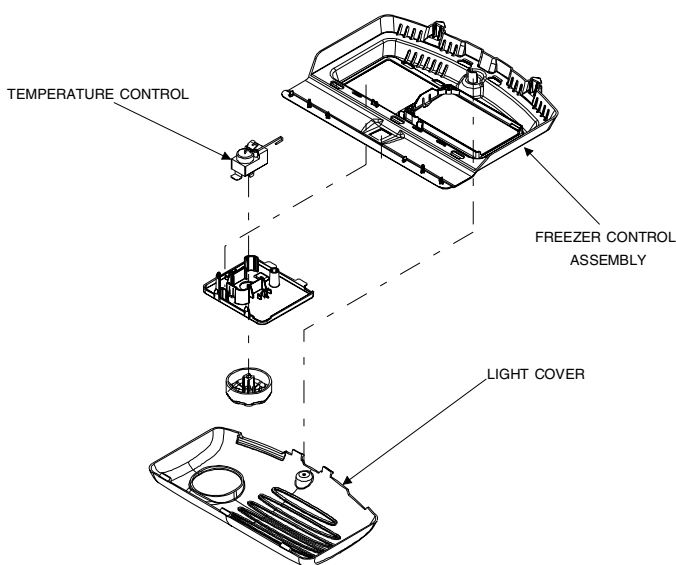

Light Socket

1. Remove screw from rear edge of light shield.
2. Squeeze lens to release lens cover and remove.
3. With flat blade screwdriver release tabs in front of cold control knob.
4. Cold control assembly will drop down when released.
5. Remove light bulb.
6. Squeeze tab holding light housing in place to release housing and remove.
7. Disconnect wires to socket.
8. Squeeze tab on back side of housing to release socket.

Light Switch

1. Carefully pry with taped putty knife pry the front of light bulb assembly to release tabs.
2. The whole light bulb assembly will drop down.
3. Disconnect wiring to light switch.
4. Squeeze tabs on back side of switch to release it from assembly.

Freezer Back Panel

NOTE: Freezer compartment should now be empty and walls should be clear of anything that will obstruct removal of back panel.

1. Loosen screws that mount icemaker to freezer compartment walls.
2. Pull icemaker gently away from wall of compartment. As you do so, work fill cup free of fill tube. Unplug icemaker electrical connector and remove icemaker from unit.
3. (Pull out Drawer only) Loosen and remove screws that hold 2 basket glides in place at left and right sides of compartment.
4. If unit has no icemaker pry with flatblade icemaker connection cover. Remove cover.
5. Remove hex head screws that hold back panel and remove panel.
6. Squeeze tabs on ice maker plug to release it from back panel

Evaporator Fan, Evaporator Motor

1. Follow instructions in removing freezer back panel.
2. Remove screws that anchor evaporator fan bracket to back wall of compartment. Pull fan and bracket out of place as a unit
3. Free fan bracket from wiring harness by disconnecting wires to motor and wire in clips that go to defrost terminator.
4. Pull evaporator fan blade off motor shaft.
5. Separate bracket and motor by squeezing lower retainer bracket to release motor from bracket.
6. When reinstalling motor reference position of terminals of new motor the same as old motor.

Disassembly Procedures



WARNING

To avoid risk of electrical shock, personal injury, or death, disconnect electrical power source to unit, unless test procedures require power to be connected. Discharge capacitor through a resistor before attempting to service. Ensure all ground wires are connected before certifying unit as repaired and/or operational.

Defrost Terminator (Thermostat)

1. Terminator is fastened to evaporator tubing with a spring clip.
2. Snap terminator off tubing and cut wires to terminator.
3. Remove terminator from unit.

Defrost Heater

1. Follow instructions in removing freezer back panel.
2. Remove hex head screws retaining evaporator to back cabinet wall.
3. Disconnect plugs from both sides of heater.
4. Release connectors from air dams on each side of evaporator coil.
5. Grip evaporator tubing at left and right sides and tug evaporator sharply forward. Evaporator will pop out of plastic clips that hold it to back wall of unit. Then roll bottom of evaporator forward and up, exposing evaporator heater in its location amid fins at bottom of evaporator.
6. Taking care to notice how and where they are placed, remove spring clips that hold heater into evaporator fins.
7. Pull evaporator heater out of evaporator fins, being careful that heater electrical leads do not snag on air dams, evaporator fins, tubing or other object.

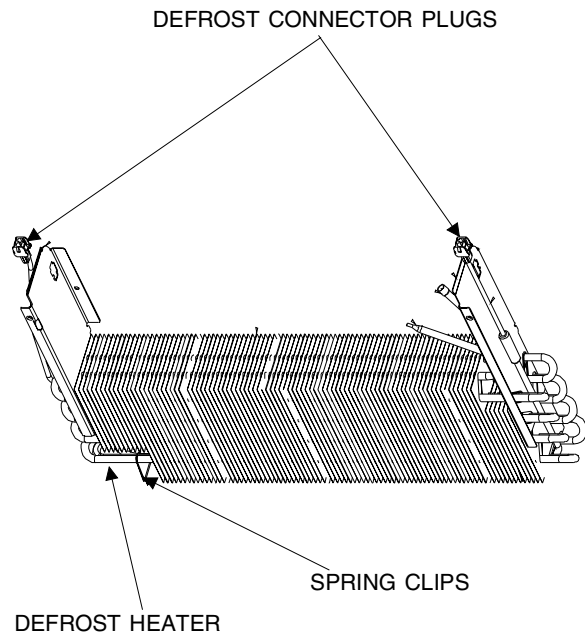

Evaporator Removal

NOTE: Reclaim refrigerant per instructions in "Service Procedures" before attempting evaporator removal. To avoid system contamination, do not leave system open for more than 10 minutes.

1. Follow instructions in removing freezer back panel.
2. Remove defrost thermostat. Refer to defrost thermostat removal.
3. Remove defrost heater. Refer to defrost heater removal.
4. Install protective cloth to prevent damage to cabinet liner
5. Unbraid suction copper fitting at evaporator.
6. Score and break copper capillary at evaporator.
7. Install new evaporator and reassemble taking care in not kinking tubing when reassembling.

Disassembly Procedures



WARNING

To avoid risk of electrical shock, personal injury, or death, disconnect electrical power source to unit, unless test procedures require power to be connected. Discharge capacitor through a resistor before attempting to service. Ensure all ground wires are connected before certifying unit as repaired and/or operational.

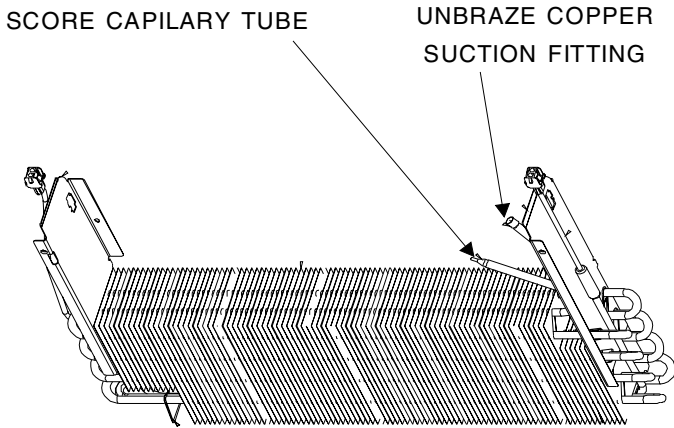

Machine Compartment

Condenser Fan & Fan Motor

1. Remove machine compartment cover.
2. Unplug wiring harness connector from fan motor.
3. On backside of fan motor, screws secure the motor to its brackets. Remove those screws.
4. Note which side of fan blade is "front" and which side is "rear." Then use pliers to loosen nut that secures fan blade to motor shaft. Remove nut and fan blade.

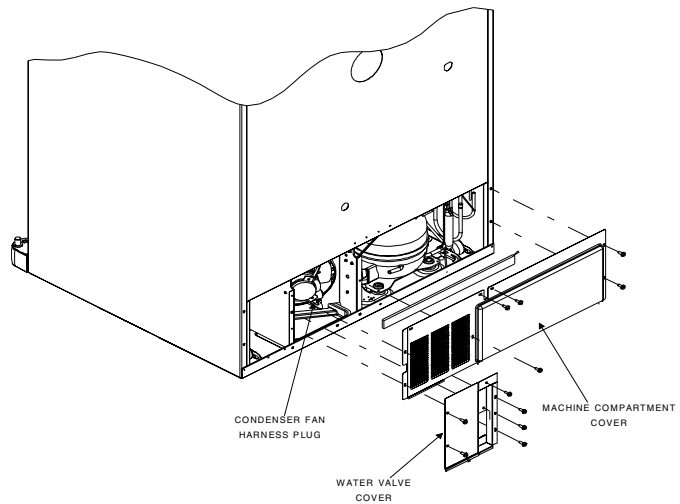

Drawer Assembly (some models)

1. Open drawer to fully open position.
2. Remove upper basket.
3. Remove screws one in each rail marked on side of rail.
4. Lift front of drawer up and out to remove drawer.

Drawer Rails

1. Remove screws inside plastic rail retainer.
2. Remove rails from retainer by depressing plastic tabs on back side of retainer.
3. Slide rails off of retainer.

Bottom of Cabinet

Front Roller Assembly

1. Remove toe grille by pulling it straight away from unit.
2. Raise front of refrigerator at least 4" off the deck and block it up.
3. Unscrew leveling bolt until wheel is free of leveling bolt.
4. Tip wheel assembly down until wheel assembly will slide out of mount from the rear of assembly.
5. Remove roller assembly from unit.

Rear Roller Assembly

NOTE: Condensate drip pan may spill when steps 1 thru 4 are performed. Have a towel ready to mop up spillage.

1. Tape both doors shut to prevent doors from opening
2. Raise back of refrigerator at least 4" off the deck and block it up.
3. Remove machine-compartment cover.
4. Locate and slide roller pins out of rollers.
5. Install new rollers and reinstall pins.

Compressor

NOTE: Install new drier and compressor per instructions in "Service Procedures." Evacuate and recharge sealed system per instructions in "Service Procedures."

1. Remove machine compartment cover.
2. Remove drier.
3. Disconnect all compressor wiring and overload/relay assembly.
4. Unbraid low and high pressure lines at compressor.
5. Remove compressor mounting bolts.
6. Lift compressor out of unit.

Overload/Relay/Capacitor

1. Remove machine compartment cover.
2. Using fingers and standard screwdriver, press and pry bale strap off the overload/relay assembly
3. Disconnect wires from overload/relay assembly. Reference wire location.
4. Unplug overload/relay assembly from compressor.

Disassembly Procedures



WARNING

To avoid risk of electrical shock, personal injury, or death, disconnect electrical power source to unit, unless test procedures require power to be connected. Discharge capacitor through a resistor before attempting to service. Ensure all ground wires are connected before certifying unit as repaired and/or operational.

Condensate Drain Pan

NOTE: Condensate drip pan may spill when steps 1 thru 4 are performed. Have a towel ready to mop up spillage.

1. Remove machine compartment cover.
2. Tape both doors shut to prevent doors from opening
3. Raise back of refrigerator at least 4" off the deck and block it up.
4. Remove Rear torx head screws holding base pan and loosen front torx head screws on bottom of cabinet.
5. Carefully lower basepan taking care not to kink tubing to compressor or condenser.
6. Remove hex screws holding condenser fan shroud to basepan.
7. Lift shroud up and out of the way to allow removal of condensate drain pan.
8. Remove drain pan.

Condensate Drain Tube

1. Remove machine compartment cover.
2. Drip tube is mounted to bottom of cabinet with clip. Reach into machine compartment and squeeze the clip to release drain tube.
3. Pull drip tube down, off drain nipple and back, out of unit.

Condenser Removal

NOTE: Install new drier per instructions in "Service Procedures." Evacuate and recharge sealed system per instructions in "Service Procedures."

1. Remove machine compartment covers.
2. Unbraid tubing going to PC loop and heat exchanger.
3. Disconnect all machine compartment wiring at molex plug to cabinet
4. Tape both doors shut to prevent doors from opening
5. Raise back of refrigerator at least 6" off the deck and block it up.
6. Remove torx head screws to drop base pan and condenser out of unit.
7. Remove basepan and condenser out of unit.
8. Unbraid discharge and condenser out at condenser.
9. Unsnap condenser from basepan and replace.

Appendix A



Owner's Manual

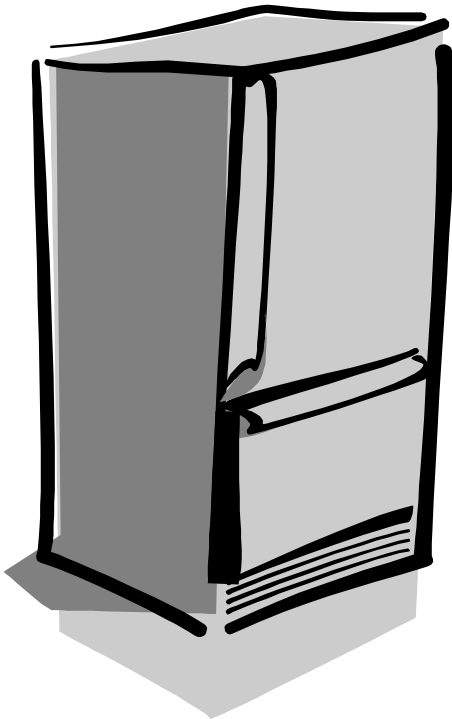

Keep instructions for future reference.

Keep this manual and your sales receipt together in a safe place in case warranty service is required.

Contents

- Introduction 3
- Important Safety Information 4
- Installing Your Refrigerator 5
 - How to Remove the Doors and Hinges 5
 - How to Reverse the Doors 6
 - How to Install and Remove Handles 6
 - How to Replace the Doors and Hinges 7
- How to Remove and Install the Pullout Drawer 8
- How to Connect the Water Supply 9
- How to Level Your Refrigerator 10
- How to Adjust the Temperature Controls 10
- Fresh Food Features 11
 - Interior Shelves 11
 - Door Storage 11
 - Accessories 11
 - Climate-Controlled Drawers 12
 - Storage Drawers 12
- Freezer Features 13
 - Primary Features 13
 - Shelves 13
 - Drawers 13
 - Door Storage 13
 - Accessories 14
- Hints and Care 15
 - How to Clean Your Unit 15
 - How to Remove and Replace Light Bulbs 16
- Trouble Shooting 17
- Warranty 20

Bottom Freezer Refrigerator

**Ordering parts and accessories?
Questions about your features?**

Please contact us with your model and serial number:

Consumer Affairs Department
Amana Appliances
2800 - 220th Trail
Amana, Iowa 52204
Ph# 1(800)843-0304 in U.S.A.
1(866)587-2002 au Canada
Internet: <http://www.amana.com>

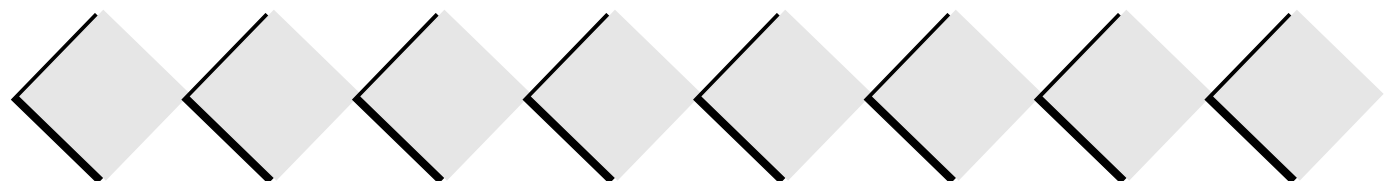

Thank you for buying an Amana refrigerator!

Please read this Owner's Manual thoroughly. This manual provides proper maintenance information.

Complete registration card and promptly return. If registration card is missing, call the Consumer Affairs Department.

Warranty service must be performed by an authorized servicer. Amana also recommends contacting an authorized servicer if service is required after warranty expires. To locate an authorized servicer, call **1-800-NAT-LSVC (1-800-628-5782)**, or call **1(319)622-5511** if outside the U.S.A. You may also contact us on the web at **www.amana.com**.

When contacting Amana, please provide the following information. Product information is on the serial plate, located on ceiling of fresh food section.

Model Number _____

'P' Number _____

Serial Number _____

Purchase Date _____

Dealer Name _____

Dealer Address _____

Dealer Phone _____

Asure™ Extended Service Plan

Amana offers long-term service protection for this new refrigerator. **Asure™ Extended Service Plan** is specially designed to supplement Amana's strong warranty. This plan covers parts, labor, and travel charges. Call **1(800)528-2682**, or contact us at **www.amana.com** for more information.

Before Calling Service...

If something seems unusual, please check "Trouble Shooting" section, which is designed to help you solve problems before calling service.

What if These Features are Different from Mine?

This book is intended to show the variety of features that are available in the product line. If your refrigerator does not have all the options that are shown, many of these options may be purchased by contacting the Consumer Affairs Department. See contact information on the cover of your manual.

Important Safety Information

Recognize Safety Symbols, Words, Labels



DANGER

DANGER—Immediate hazards which **WILL** result in severe personal injury or death.



WARNING

WARNING—Hazards or unsafe practices which **COULD** result in severe personal injury or death.



CAUTION

CAUTION—Hazards or unsafe practices which **COULD** result in minor personal injury or product or property damage.

What You Need to Know about Safety Instructions

Warning and Important Safety Instructions appearing in this manual are not meant to cover all possible conditions and situations that may occur. Common sense, caution, and care must be exercised when installing, maintaining, or operating refrigerator. Always contact your dealer, distributor, service agent, or manufacturer about problems or conditions you do not understand.



WARNING

To reduce risk of fire, electric shock, serious injury, or death when using your refrigerator, follow these basic precautions, including the following:

1. Read all instructions before using refrigerator.
2. Observe all local codes and ordinances
3. Be sure to follow grounding instructions.
4. Check with a qualified electrician if you are not sure this appliance is properly grounded.
5. DO NOT ground to a gas line.
6. DO NOT ground to cold water pipe.
7. Refrigerator is designed to operate on a separate 103 to 126 volt, 15 amp., 60 cycle line. DO NOT modify plug on power cord. If plug does not fit electrical outlet, have proper outlet installed by a qualified electrician.
8. DO NOT use a two-prong adapter, extension cord or power strip.
9. DO NOT remove warning tag from power cord.
10. DO NOT tamper with refrigerator controls.
11. DO NOT service or replace any part of refrigerator unless specifically recommended in owner's manual or published user-repair instructions. DO NOT attempt service if instructions are not understood or if they are beyond personal skill level.
12. Always disconnect refrigerator from electrical supply before attempting any service. Disconnect power cord by grasping the plug, not the cord.
13. Install refrigerator according to Installation Instructions. All connections for water, electrical power, and grounding must comply with local codes and be made by licensed personnel when required.
14. Keep your refrigerator in good condition. Bumping or dropping refrigerator can damage unit or cause unit to malfunction or leak. If damage occurs, have refrigerator checked by qualified service technician.
15. Replace worn power cords and/or loose plugs.
16. Always read and follow manufacturer's storage and ideal environment instructions for items being stored in refrigerator.



DANGER

To reduce risk of injury or death, follow basic precautions, including the following:

Proper Disposal of Your Refrigerator

IMPORTANT: Child entrapment and suffocation are not problems of the past. Junked or abandoned refrigerators are still dangerous—even if they sit out for "just a few days". If you are getting rid of your old refrigerator, please follow the instructions below to help prevent accidents.

BEFORE YOU THROW AWAY YOUR OLD REFRIGERATOR OR FREEZER:

- Take off the doors.
- Leave the shelves in place so children may not easily climb inside.

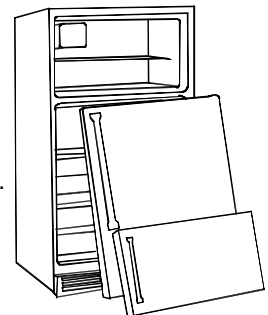

Save These Instructions

Installing Your Refrigerator

These instructions were provided to aid you in the installation of your unit. Amana cannot be responsible for improper installation.

How do I measure an opening to insure proper fit?

A 1/2" of air space should be provided for the top and back of the unit to allow for proper air circulation. When installing your unit, measure carefully. Subflooring or floor coverings (i.e. carpet, tile, wood floors, rugs) may make your opening smaller than anticipated.

Some clearance may be gained by using the leveling procedure under *How to Level Your Refrigerator*.

IMPORTANT: If unit is to be installed into a recess where top of unit is completely covered, use dimensions from floor to top of hinge cap to verify proper clearance.

How to Transport Your Unit

Follow these tips when moving the unit to final location:

- NEVER transport unit on its side. If an upright position is not possible, lay unit on its back. Allow unit to sit upright for approximately 30 minutes prior to plugging unit in to assure oil return to the compressor. Plugging unit in immediately may cause damage to internal parts.
- Use an appliance dolly when moving unit. ALWAYS truck unit from its side—NEVER from its front or back.
- Protect outside finish of unit during transport by wrapping cabinet in blankets or inserting padding between the unit and dolly.
- **Secure unit to dolly firmly with straps.** Thread straps through handles when possible. DO NOT overtighten. Overtightening restraints may dent or damage outside finish.

How to Select the Best Location

Observe these points when choosing the final location for your unit:

- DO NOT install refrigerator near oven, radiator, or other heat source. If not possible, shield unit with cabinet material.
- DO NOT install where temperature falls below 55°F (13°C). Malfunction may occur at this temperature.
- Make sure floor is level. If floor is not level, shim rear wheels of unit with a piece of plywood or other shim material.
- To assure proper door closure, verify that the unit is leveled with a 1/4" tilt to the back.

How to Remove the Doors and Hinges

Some installations require door removal to get refrigerator to final location. If removal of the pullout drawer is required, see later section entitled **How to Remove and Install the Pullout Drawer**



WARNING

To avoid electrical shock which can cause severe personal injury or death, observe the following:

- Disconnect power to refrigerator before removing doors. Connect power only after replacing doors.



CAUTION

To avoid damage to walls and flooring, protect soft vinyl or other flooring with cardboard, rugs, or other protective material.

1 Unplug power cord from power source.

2 Remove toe grille and bottom bracket cover(s).

- Open freezer door as wide as possible.
- Depending on the model of your unit, you may have one or two bracket covers.

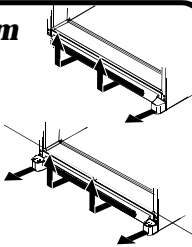

3 Remove top hinge cover by removing Phillips screw.

- Retain screw and cover for replacement.

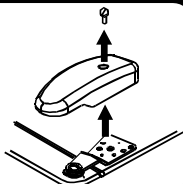

4 Unscrew 5/16" hex head screws from top hinge to remove hinge.

- Retain all screws for later use.

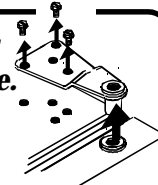

5 Lift refrigerator door from center hinge pin.

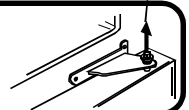

6 Hold freezer door in place while removing center hinge pin with a 5/16" hex nut driver. Remove freezer door.

- Retain hinge pin for later use.

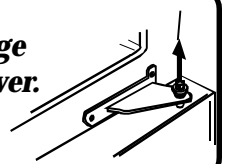

7 Remove Phillips screws to remove center hinge.

- Retain all screws for later use.

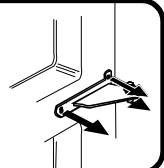

8 Remove bottom hinge or stabilizing bracket with 3/8" hex head driver.

- Lift out bottom hinge pin (some models).
- Retain hinge pin and screws for later use.

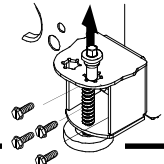

Installing Your Refrigerator

How to Reverse the Doors

1 Perform all steps listed in How to Remove the Doors and Hinges.

2 Transfer cabinet plugs and cabinet screws to opposite side of cabinet.

- Remove cabinet plugs with flat blade screwdriver tip wrapped in masking tape.
- Remove center mullion screws with $\frac{5}{16}$ " hex head driver.
- **For swing doors only** Remove bottom mullion screws with $\frac{3}{8}$ " hex head driver.

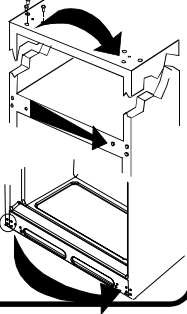

IMPORTANT: When working directly on doors, place doors on a nonabrasive surface protected by towels or rugs to avoid damage to door finish.

3 Transfer door stops from bottom edge of fresh food and freezer door to opposite side of door edge.

- Use a Phillips screwdriver for removal and installation.

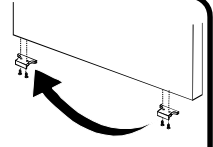

4 See How to Install and Remove Handles to **remove and reinstall handles.**

5 Proceed to How to Replace the Doors and Hinges to **mount doors.**

How to Install and Remove Handles

Installing Fresh Food Front-Mounted Handles

If installing handles for the first time, the fresh food handles can be located within the fresh food section. The handle trim will be located in the literature pack.

1 Remove $\frac{1}{4}$ " hex nut screws from door face with hex nut driver.

- If reversing door, remove door plugs from opposite side of door and insert in screw holes.

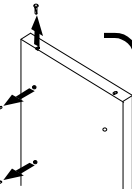

2 Align handle holes with screw holes on door face and secure with 2 door face screws from step 1.

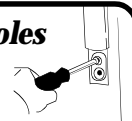

3 Locate handle trim in literature pack and install over top and bottom of handle, as illustrated.

- Secure top handle trim with remaining screw removed in step 1.
- Snap bottom trim over bottom portion of handle.



Removing Fresh Food Front-Mounted Handles

Removing handles may be necessary when transporting unit through tight spaces, or when reversing the door.

1 Remove top handle trim by removing top handle screw.

- Retain trim and screw for later replacement.

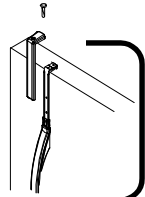

2 Pry bottom handle trim from handle with screwdriver flat blade wrapped in masking tape.

- Retain trim for later replacement.

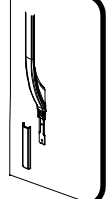

3 Remove two remaining handle screws and remove handle.

- Retain screws for later replacement.

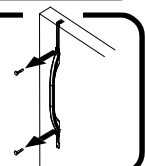

Installing Freezer Handles

If installing handles for the first time, the freezer handles can be located within the freezer section.

Install handle by fastening with screws removed from edge of door.

- If reversing freezer door, remove door plugs from top edge of door and insert into screw holes.

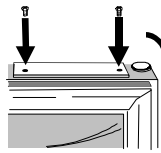

Removing Freezer Handles

Removing handles may be necessary when transporting unit through tight spaces, or when reversing the door.

Remove handle screws with Phillips screwdriver:

- Retain screws for later replacement.

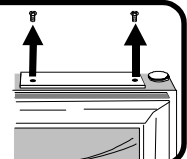

Installing Your Refrigerator

How to Install and Remove Handles *continued*

Installing Fresh Food Side-Mounted Handles

If installing handles for the first time, the fresh food handles can be located on the back of the refrigerator.

Install handle by fastening with screws removed from edge of door.

NOTE: If reversing door, remove door plugs from opposite side of door and insert in screw holes.

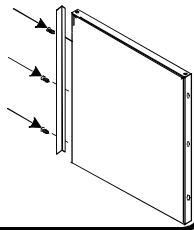

Removing Fresh Food Side-Mounted Handles

Removing handles may be necessary when transporting unit through tight spaces, or when reversing the door.

Remove handle by removing three screws from side of door.

- Retain screws for later replacement.

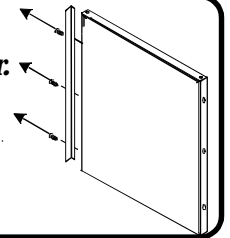

Installing Freezer Handles

If installing handles for the first time, the freezer handles can be located on the back of the refrigerator.

Install handle by fastening with screws removed from edge of door.

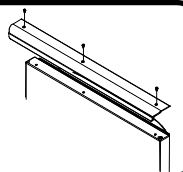

Removing Freezer Handles

Removing handles may be necessary when transporting unit through tight spaces.

Remove handle by removing three screws from handle.

- Retain screws for later replacement.

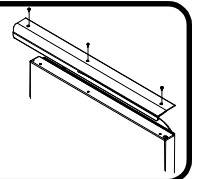

Installing and Removing Stainless Steel Front-Mounted Handles



DANGER

To avoid risk of serious personal injury from sharp edges, do not remove front-mounted stainless steel handles from unit.

How to Replace the Doors and Hinges

1 Install hinge assemblies.

- Install top hinge *loosely* with $\frac{5}{16}$ " hex head screws.
- Install center hinge with Phillips screws.
- Install bottom hinge with $\frac{3}{8}$ " hex head screws.

2 Insert bottom hinge pin (some models).

- Locate bottom hinge hole closest to outside edge of cabinet, and insert bottom hinge pin. Replace any door shims, if present.

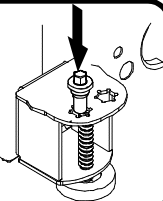

3 Place hinge side of freezer door on bottom hinge pin and hold freezer door upright while installing center hinge pin with $\frac{5}{16}$ " hex head driver.

- Replace any applicable door shims.
- Make sure the hinge pin is installed tight.

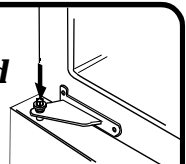

4 Place hinge side of refrigerator door on center hinge pin.

5 While holding refrigerator door upright, tighten down top hinge with $\frac{5}{16}$ " hex head driver and replace hinge cover.

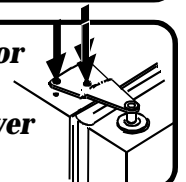

Installing Your Refrigerator

How to Remove and Install the Pullout Drawer

WARNING

To avoid electrical shock which can cause severe personal injury or death, disconnect power to refrigerator before removing doors. After replacing doors, connect power.

CAUTION

To avoid possible injury, product, or property damage, you will need two people to perform the following instructions.

Removing Pullout Drawer

- 1 Pull drawer open to full extension. Remove Phillips screw from each side of rail system.**

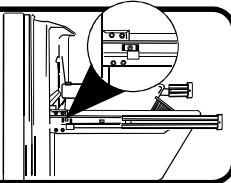

- 2 Remove lower basket by lifting basket from rail system.**

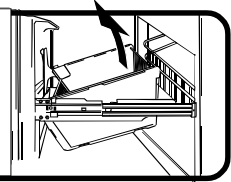

- 3 Pull upper basket out to full extension, and lift out to remove.**

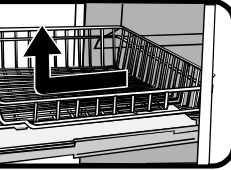

- 4 Lift top of door to unhook door supports from rail system. Lift door out to remove.**

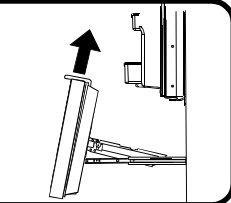

Installing Pullout Drawer

- 1 Pull both rails out to full extension.**

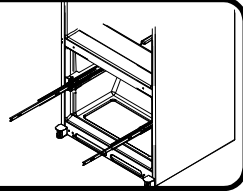

- 2 Hook door supports into rail tabs, as illustrated, and lower door into final position.**

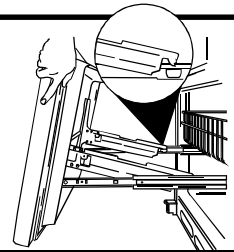

- 3 With drawer pulled out to full extension, insert lower basket by aligning tabs on both side of lower basket with notches in rail assembly.**

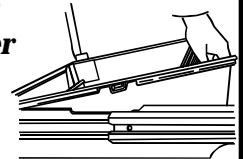

- 4 Slide upper basket into unit. Make sure that rear of basket hooks behind rail catch.**

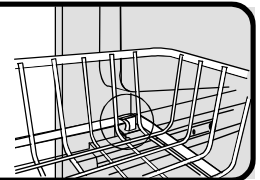

Installing Your Refrigerator

How to Connect the Water Supply

WARNING

To reduce the risk of injury or death, follow basic precautions, including the following:

- Read all instructions before installing device.
- DO NOT attempt installation if instructions are not understood or if they are beyond personal skill level.
- Observe all local codes and ordinances.
- DO NOT service device unless specifically recommended in owner's manual or published user-repair instructions.
- Disconnect power to unit prior to installing device.

CAUTION

To avoid property damage or possible injury, follow basic precautions, including the following:

- Consult a plumber to connect copper tubing to household plumbing to assure compliance with local codes and ordinances.
- Confirm water pressure to water valve is between 20 and 100 pounds per square inch. If water filter is installed, water pressure to water valve must be a minimum of 35 pounds per square inch.
- **DO NOT use a self-piercing, or $\frac{3}{16}$ " saddle valve!** Both reduce water flow, become clogged with time, and may cause leaks if repair is attempted.
- Tighten nuts by hand to prevent cross threading. Finish tightening nuts with pliers and wrenches. Do not overtighten.
- Wait 24 hours before placing unit into final position to check and correct any water leaks.

Materials Needed

- $\frac{1}{4}$ " outer diameter flexible copper tubing

- Shut-off valve (requires a $\frac{1}{4}$ " hole to be drilled into water supply before valve attachment)

- Adjustable wrench
- $\frac{1}{4}$ " hex nut driver

NOTE: Add 8' to tubing length needed to reach water supply for creation of service loop.

- 1** Create service loop with tubing using care to avoid kinks in tubing.

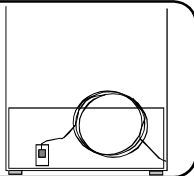

- 2** Remove plastic cap (A) from water valve inlet port (B).

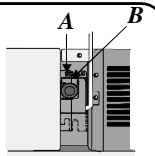

- 3** Place brass nut (D) and sleeve (E) on copper tube end as illustrated.

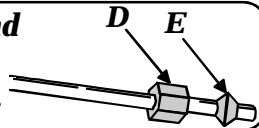

- 4** Place end of copper tubing into water valve inlet port. Shape tubing slightly—DO NOT KINK—so that tubing feeds straight into inlet port.

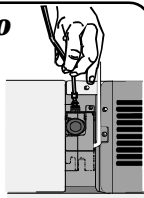

- 5** Slide brass nut over sleeve and screw nut into inlet port. Tighten nut with wrench.

IMPORTANT: DO NOT overtighten. Cross threading may occur.

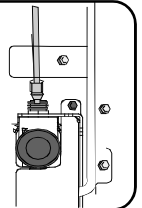

- 6** Pull on tubing to confirm connection is secure. Connect tubing to frame with water tubing clamp (F) and turn on water supply. Check for leaks and correct, if present.

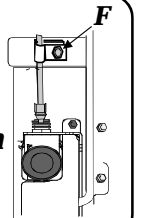

- 7** Monitor water connection for 24 hours. Correct leaks, if necessary.

Installing Your Refrigerator

How to Level Your Refrigerator

If your refrigerator requires an ice maker water supply connection, proceed to How to connect the water supply section before leveling your refrigerator.

CAUTION

To protect personal property or unit from damage, observe the following:

- Protect soft vinyl or other flooring with cardboard, rugs, or other protective material.
- Do not use power tools when performing leveling procedure.

Materials Needed • $\frac{3}{8}$ " hex head driver • Level

1 Move refrigerator to final location and plug in power cord.

2 Remove toe grille and bottom cover(s)

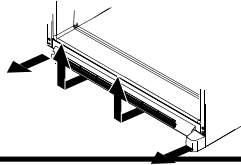

3 Turn left and right adjustment screws (A) to raise or lower front of refrigerator.

- Make sure refrigerator cabinet is level from side to side by adjusting left and right roller adjustment screws.
- Turn stabilizing leg clockwise until firmly against floor.

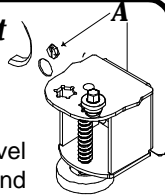

For Pullout Drawer Models: After completing the above listed steps, turn roller adjustment screws (A) 2 to 3 times counterclockwise, so that full weight of unit rests on stabilizing legs.

4 Using a level, make sure front of refrigerator is $\frac{1}{4}$ " (6 mm) or $\frac{1}{2}$ bubble higher than back of refrigerator.

- See leveling step 3 for assistance.

5 Replace toe grille and bracket cover(s). See markings on inside of toe grille to insure proper placement.

- Snap bottom portion into place first. Press down on top part of grille until top portion snaps into place.

How to Adjust the Temperature Controls

This refrigerator is designed to operate at a household temperature of 55° to 110°F (13° to 43° C). For initial temperature setting, follow all five steps listed below. If doing a simple temperature modification for an operational unit, only steps 3 through 5 are required.

1 Locate refrigerator controls at the top of fresh food compartment and freezer controls at top of freezer section. Set both controls to 4. **IMPORTANT:** Neither section will cool if freezer control is set to Off.

2 Allow 24 hours for temperatures to stabilize.

3 Check to see if freezer temperature is 0° to 2° F (-17° to -16° C).

- Turn control to next highest number if too warm.
- Turn control to next lowest number if too cold. Allow 5 to 8 hours for adjustments to take effect.

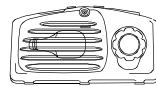

4 Check to see that fresh food section is 38° to 40° F (3° to 4° C).

- Turn control to next highest number if too warm.
- Turn control to next lowest number if too cold.
- Allow 5 to 8 hours for adjustments to take effect.

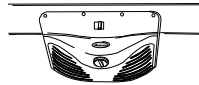

5 Repeat steps 3 & 4, as necessary.

How do I perform a temperature test?



Materials needed

- 2 thermometers measuring -5° to 50°F (-21° to 10°C)
- 2 drinking glasses

For Freezer

- Place thermometer in glass of vegetable oil in middle of freezer and continue with step 3 of Temperature Adjustment section.

IMPORTANT: Always start temperature adjustments with freezer section.

For Refrigerator

- Place thermometer in glass of water in middle of unit and continue with step 3 of Temperature Adjustment section.

Fresh Food Features

Interior Shelves

CAUTION

To avoid personal injury or property damage, observe the following:

- Confirm shelf is secure before placing items on shelf.
- Handle tempered glass shelves carefully. Shelves may break suddenly if nicked, scratched, or exposed to sudden temperature change.

Full-Width Shelf

- To remove shelves, unhook shelf from rear ladder assembly and pull out.
- To install shelves, insert shelf hooks into rear ladder assembly and lower into place.

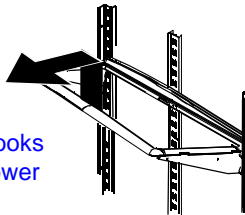

Spillsaver™ *some models*

Spillsaver™ stationary shelves hold simple spills for easier cleaning.

- To remove shelves, lift up and out.
- To install shelves, reverse above procedure.

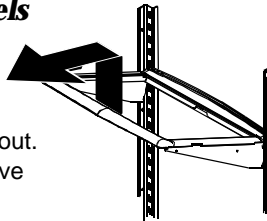

Spillsaver™ EasyGlide™ *some models*

Spillsaver™ EasyGlide™ shelves feature the convenience of easy cleaning with a pullout design to reach items in the back. For ease of cleaning, glass shelf may be removed by pulling to full extension and lifting out of frame.

- To remove shelf and frame, see instructions for Spillsaver™ stationary shelves.

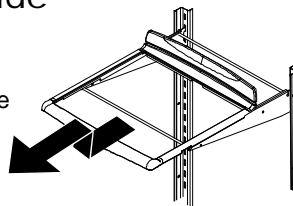

Rear Shelf Extensions *some models*

Rear shelf extensions help prevent articles from falling off the back of the shelf.

To remove and install shelf extension:

- To remove, pull extension straight up from rear of shelf.
- To install, insert posts of the shelf extension into holes in the shelf frame.

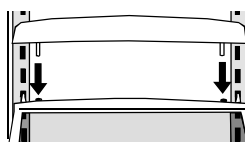

Door Storage

Dairy Center

The dairy center provides convenient storage for items such as butter, yogurt, cheese, etc. This compartment is an adjustable feature located in the door. It can be moved to several different locations to accommodate storage needs.

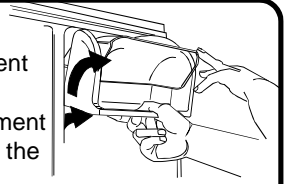

- To remove, open dairy door, pull upward and tilt out.
- To install, reverse above procedure.

Door Buckets

Door buckets adjust to meet individual storage needs.

- To remove, slide bucket up and pull straight out.
- To install, reverse above procedure.

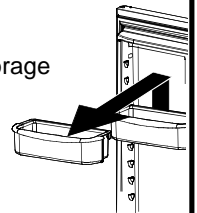

Door Retainer

Door retainers remove for easy cleaning.

- To remove, slide retainer up and pull straight out.
- To install, reverse above procedure.

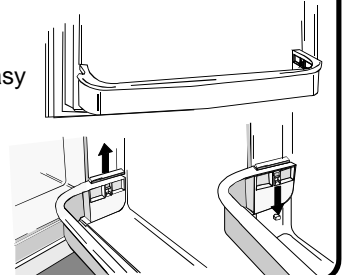

Accessories

Grip Pads *some models*

The Grip Pads prevents objects from sliding in the door bucket. Grip Pads are removable and are top-rack dishwasher safe for easy cleaning.

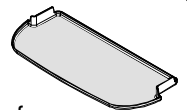

Wine Trivet/Can Rack *some models*

The Wine Trivet/Can Rack accessory fits in the bottom of most drawer assemblies.

Beer bottles can be laid cross-wise, or a single bottle may be laid in the center depression. Cans may also be stored, as illustrated.

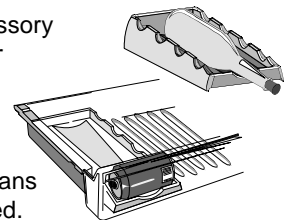

Pantry Divider *some models*

The pantry divider is used to organize the Chef's Pantry™ into sections, and features a collapsible joint on the front edge to ensure a snug fit.

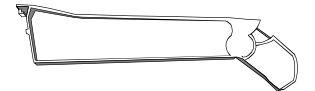

NOTE: For easiest execution, remove pantry. If removal is not possible, pull drawer open to its fullest extension.

To remove and replace divider:

- To remove, unhook divider from rear wall of pantry, and pull out.
- To install, hook back of divider over rear wall of pantry and press down until front joint snaps into place.

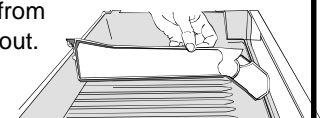

Fresh Food Features

Climate-Controlled Drawers

Humidity-Controlled Crisper Drawers

The crisper drawer keeps produce fresh longer by providing an environment with adjustable humidity.

Controls

The crisper controls regulate the amount of humidity in the crisper drawer. Use the *low* setting for produce with outer skins. Use the *high* setting for leafy produce.

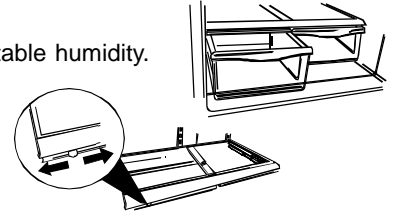

Temperature-Controlled Drawer

Chef's Pantry™

The Chef's Pantry™ system provides a drawer with a variable temperature control that keeps the compartment up to 5°F (3°C) colder than refrigerator temperature. This drawer can be used for large party trays, deli items, or beverages.

Control

The Chef's Pantry™ control regulates the air temperature in the drawer. Set control level to *cold* to provide normal refrigerator temperature. Use the *coldest* setting for meats or other deli items.

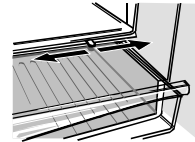
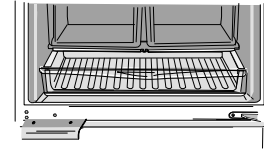

NOTE: Cold air directed to the Chef's Pantry™ can decrease refrigerator temperature. Refrigerator control may need to be adjusted.

Storage Drawers

Snack Drawer

This drawer can be used for storage of food items or extra produce.

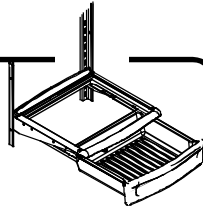

Beverage Organizer™ *some models*

The Beverage Organizer™ slides out from underneath the Spillsaver™ stationary shelf. The Beverage Organizer™ holds up to twelve 12-ounce beverage cans.

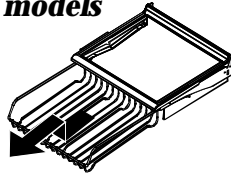

What if I can't open my door wide enough to remove the drawers?

- Remove drawer furthest from hinge side of cabinet.
- Remove glass as previously instructed.
- Lift center divider from frame. Slide existing drawer away from hinge side of cabinet and remove.

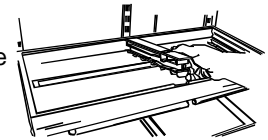

What can I do to prolong the life of my produce?

Please observe the following rules when storing produce in humidity-controlled crisper drawers:

- DO NOT wash produce before placing in crispers. Any additional moisture added to the drawers may cause produce to prematurely spoil.
- DO NOT line crispers with paper towels. Towels will retain moisture.
- Follow control instructions carefully. Not setting controls correctly may damage produce.

See chart below for assistance with controls:

- LOW**
- cauliflower
 - apples
 - corn
 - oranges
 - zucchini
 - grapes
 - cucumbers

- HIGH**
- lettuce
 - asparagus
 - spinach
 - cabbage
 - celery
 - broccoli
 - fresh sprouts
 - fresh herbs

To remove and install drawers:

- To remove drawer, pull drawer out to full extension. Tilt up front of drawer and pull straight out.
- To install, insert drawer into frame rails and push back into place.

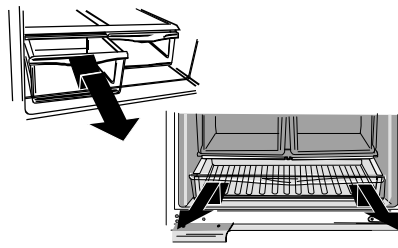

To remove and install glass and frame:

- Remove drawers as instructed above.
- Place hand beneath frame to push up glass from underneath. Lift glass out.
- Lift frame from refrigerator liner rails.
- To install, repeat above instructions in reverse order.

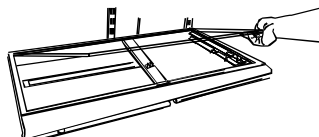

Freezer Features

Primary Features

Automatic Ice Maker *(some models)*

Using Ice Maker for the First Time

- Confirm ice bin is in place and ice maker arm is down.
- After freezer section reaches between 0° to 2°F (-18° to -17° C), ice maker fills with water and begins operating.
- Allow approximately 24 hours after installation to receive first harvest of ice.
- Discard ice created within first 12 hours of operation to verify system is flushed of impurities.

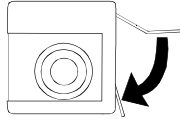

Operating Instructions

- Confirm ice bin is in place and ice maker arm is down.
- After freezer section reaches 0° to 2°F (-18° to -17° C), ice maker fills with water and begins operating. You will have a complete harvest of ice approximately every 3 hours.
- Stop ice production by raising ice maker arm until click is heard.
- Ice maker will remain in the *off* position until arm is pushed down.

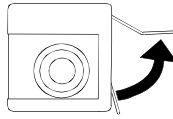

Shelves

Ice Service Rack

To install and remove rack:

- To install, slide L-shaped groove of shelf down over back wall screw. Push rack back until screw is stopped in L-shaped groove (1). Slide front portion of shelf over front wall screw (2).
- To remove, perform above steps in reverse order.

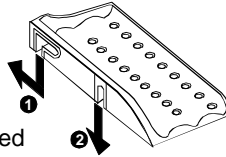

Fixed Freezer Shelf

To remove and install shelves:

- Remove shelf by pulling out to full extension. Tilt up front of shelf and pull straight out.
- To install, insert shelf into refrigerator liner rails and push to back of compartment.

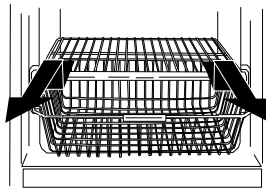

Slide-Out Freezer Shelf

To remove and install shelves:

- Remove shelf by pulling out to full extension. Tilt up front of shelf and pull straight out.
- To install, insert shelf into refrigerator liner rails and push to back of compartment.

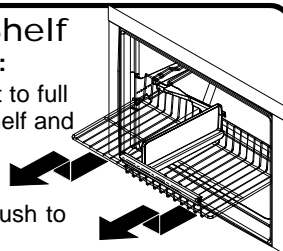

CAUTION

To avoid property damage, observe the following:

- Do not force ice maker arm down or up.
- Do not place or store anything in ice storage bin.

Drawers

Wire Basket

To remove and install basket:

- To remove basket, pull basket out to full extension. Tilt up front of basket and pull straight out.
- To install, insert basket into refrigerator liner rails and push back into place.

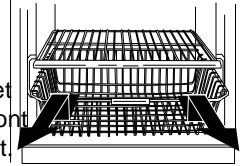

Pullout Drawer Baskets *(some models)*

(Door assembly of drawer removed from illustration for visual clarity)

To remove and replace top basket:

- Remove basket by pulling basket out to its full extension and lift out.
- Replace basket by sliding into upper molded railing.

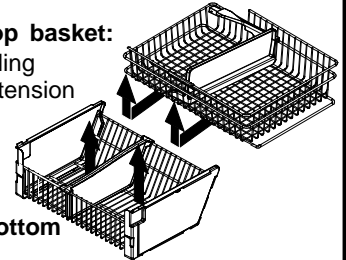

To remove and replace bottom basket:

- Remove basket by lifting basket from rail guides.
- Replace basket by placing into rail guides.

Door Storage

Fixed Door Shelf

The fixed door shelf provides convenient storage for frozen food items in freezer door.

To remove and install door shelf:

- To remove shelf, lift assembly from side liner tabs and pull out.
- To install, fit ends of shelf assembly on liner tabs and slide down.

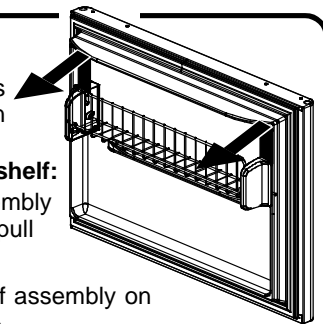

Tilt-Out Bin *(some models)*

The tilt-out bin (A) provides convenient storage for frozen food items in freezer door and tilts forward for easy access of those items.

To remove and install door shelf:

- See above instructions listed for Fixed Door Shelf.

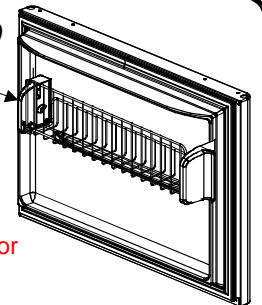

Freezer Features

Accessories

Ice Cube Tray *(some models)*

The ice cube tray provides an area to freeze cubes for manual dispensing of ice.

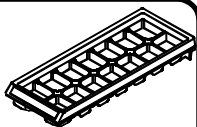

To release ice cubes from tray, hold tray upside down over a storage container and twist both ends of tray until cubes release.

Lower Basket Divider *(some models)*

The lower basket divider allows the option to organize the basket area into sections.

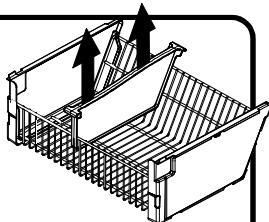

To remove and replace divider:

- To remove, pull divider straight up.
- To install, hook top corners of divider over top horizontal basket rungs.

Hints and Care

What cleaners does Amana recommend for my stainless steel product?

Amana has a cleaner available for purchase (Part # 31960801) through our Consumer Affairs division. For this, or a list of other recommended cleaning products, please contact us at Amana Consumer Affairs using the information on the cover of your Owner's Manual.

How to Clean Your Unit



WARNING

To avoid electrical shock which can cause severe personal injury or death, disconnect power to refrigerator before cleaning. After cleaning, connect power.

CAUTION

To avoid personal injury or property damage:

- Read and follow manufacturer's directions for all cleaning products.
- Do not place buckets, shelves, or accessories in dishwasher. Cracking or warping of accessories may result

How do I remove an odor from my refrigerator?

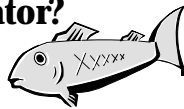

1. Remove all food.
2. Disconnect refrigerator.
3. Clean the following items using the appropriate instructions in *How to Clean Your Unit* :
 - Walls, floor, and ceiling of cabinet interior.
 - Drawers, shelves, and gaskets according to the instructions in this section.
4. Pay special attention to clean all crevices by completing the following steps:
 - Dilute mild detergent and brush solution into crevices using a plastic bristle brush.
 - Let stand for 5 minutes.
 - Rinse surfaces with warm water. Dry surfaces with a soft, clean cloth.
5. Wash and dry all bottles, containers, and jars. Discard spoiled or expired items.
6. Wrap or store odor-causing foods in tightly-sealed containers to prevent reoccurring odors.
7. Connect power to refrigerator and return food to unit.
8. After 24 hours, check if odor has been eliminated.

If odor is still present...

1. Remove drawers and place on top shelf of refrigerator.
2. Pack refrigerator and freezer sections—including doors—with crumpled sheets of black and white newspaper.
3. Place charcoal briquettes randomly on crumpled newspaper in both freezer and refrigerator compartments.
4. Close doors and let stand 24–48 hours.
5. Repeat steps 5 through 7.

AREA	DO NOT USE	DO...
Textured Doors and Exterior Cabinet Interior	<ul style="list-style-type: none"> • Abrasive or harsh cleaners • Ammonia • Chlorine bleach • Concentrated detergents or solvents • Metal or plastic-textured scouring pads 	<ul style="list-style-type: none"> • Use 4 tablespoons (60 milliliters) of baking soda dissolved in 1 quart (1 liter) warm soapy water. • Rinse surfaces with clean warm water and dry immediately to avoid water spots
Stainless Steel Doors and Exterior <i>IMPORTANT: Damage to stainless steel finish due to improper use of cleaning products or non-recommended products is not covered under any warranty</i>	<ul style="list-style-type: none"> • Abrasive or harsh cleaners • Ammonia • Chlorine bleach • Concentrated detergents or solvents • Metal or plastic-textured scouring pads • Vinegar-based product • Citrus-based cleaners 	<ul style="list-style-type: none"> • Use warm, soapy water and a soft, clean cloth or sponge. • Rinse surfaces with clean warm water and dry immediately to avoid water spots
Door Gaskets	<ul style="list-style-type: none"> • Abrasive or harsh cleaners • Metal or plastic-textured scouring pads 	<ul style="list-style-type: none"> • Use a vacuum cleaner hose nozzle
Condenser Coil <i>Remove toe grille to access</i>	N/A	<ul style="list-style-type: none"> • Use a vacuum cleaner hose nozzle with brush attachment.
Condenser Fan Outlet Grille <i>See back of refrigerator</i>	<ul style="list-style-type: none"> • A Dishwasher 	<ul style="list-style-type: none"> • Follow removal and installation instructions from appropriate feature section. • Allow items to adjust to room temperature. • Dilute mild detergent and use a soft clean cloth or sponge for cleaning. • Use a plastic bristle brush to get into crevices • Rinse surfaces with clean warm water. • Dry glass and clear items immediately to avoid spots.
Accessories <i>Shelves, buckets, drawers, etc</i>	<ul style="list-style-type: none"> • A Dishwasher 	<ul style="list-style-type: none"> • Follow removal and installation instructions from appropriate feature section. • Allow items to adjust to room temperature. • Dilute mild detergent and use a soft clean cloth or sponge for cleaning. • Use a plastic bristle brush to get into crevices • Rinse surfaces with clean warm water. • Dry glass and clear items immediately to avoid spots.

Hints and Care

How to Remove and Replace Light Bulbs

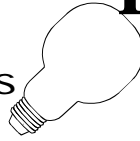

WARNING

To avoid electrical shock which can cause severe personal injury or death, disconnect power to refrigerator before replacing light bulb. After replacing light bulb, connect power.



CAUTION

To avoid personal injury or property damage, observe the following:

- Allow light bulb to cool.
- Wear gloves when replacing light bulb.



How to Get the Most Out of Your Energy Dollar

- When placing refrigerator into final position, allow for 1" clearance around the top and sides of unit to supply ample ventilation for optimum energy efficiency.
- Avoid overcrowding refrigerator shelves. This reduces effectivity of air circulation around food and causes refrigerator to run longer.
- Avoid adding too much warm food to unit at one time. This overloads compartments and slows rate of cooling.
- Do not use aluminum foil, wax paper, or paper toweling as shelf liners. This decreases air flow and causes unit to run less efficiently.
- A freezer that is $\frac{2}{3}$ full runs most efficiently.
- Locate refrigerator in coolest part of room. Avoid areas of direct sunlight, or near heating ducts, registers, or other heat producing appliances. If this is not possible, isolate exterior by using a section of cabinet or an added layer of insulation.
- Refer to owner's manual section on temperature controls for recommended control settings
- Clean door gaskets every three months according to Owner's Manual cleaning instructions. This will assure that door seals properly and unit runs efficiently.
- Take time to organize items in refrigerator to reduce time that door is open.
- Be sure your doors are closing securely by leveling unit as instructed in your Owner's Manual.
- Clean condenser coils of as indicated in the owner's manual every 3 months. This will increase energy efficiency and cooling performance.

Fresh food section

1. Remove screw from light shield. Retain for replacement.
1. Slide shield toward back of compartment to release from light assembly.
2. Remove light bulbs.
3. Replace with appliance bulbs **no greater than 40 watts**.
4. Replace light bulb cover by inserting tabs on light shield into liner holes on each side of light assembly. Slide shield toward front of unit until it locks into place. **DO NOT** force shield beyond locking point. Doing so may damage light shield.
5. Replace screw removed in step 1.

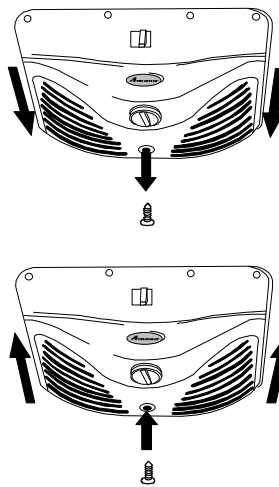

Freezer section

1. Pinch rear tabs (**A**) on light cover and pull straight out.
2. Remove light bulb.
3. Replace bulb with appliance bulb **no greater than 40 watts**.
4. Insert top tabs (**B**) of light cover into refrigerator liner and snap back portion over light assembly.

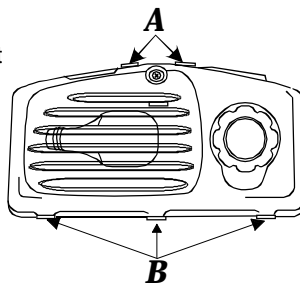

Trouble Shooting

NOISE)))

Today's refrigerators have new features and are more energy efficient. Foam insulation is very energy efficient and has excellent insulating capabilities, however, foam insulation is not as sound absorbent. As a result, certain sounds may be unfamiliar. In time, these sounds will become familiar. Please refer to this information before calling service.

TOPIC	POSSIBLE CAUSE	SOLUTION
Clicking	Freezer control (A) clicks when starting or stopping compressor.	Normal operation
	Defrost timer (B) sounds like an electric clock and snaps in and out of defrost cycle.	Normal operation
Air rushing or whirring	Freezer fan (C) and condenser fan (D) make this noise while operating.	Normal operation
Gurgling or boiling sound	Evaporator (E) and heat exchanger (F) refrigerant makes this noise when flowing.	Normal operation
Thumping	Ice cubes from ice maker (some models) drop into ice bucket (G).	Normal operation
Vibrating noise	Compressor (H) makes a pulsating sound while running.	Normal operation
	Refrigerator is not level.	See <i>Installation Instructions</i> for details on how to level your unit.
Buzzing	Ice maker water valve (I) hookup (some models) buzzes when ice maker fills with water.	Normal operation
Humming	Ice maker (J) is in the 'on' position without water connection.	Stop sound by raising ice maker arm to 'off' position. See <i>Automatic Ice Maker</i> section in your owner's manual for details.
	Compressor (H) can make a high pitched hum while operating.	Normal operation
Hissing or popping	Defrost heater (K) hisses, sizzles, or pops when operational.	Normal operation

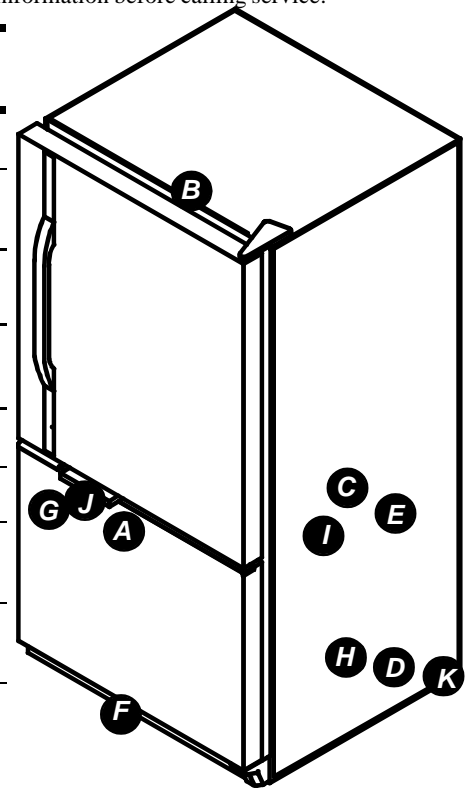

OPERATION



Freezer control and lights are on, but compressor is not operating.	Refrigerator is in defrost mode.	Normal operation Wait 40 minutes to see if refrigerator restarts.
Crisper drawer temperature is too warm	Control settings are too low.	See section on Crisper drawer to adjust controls.
	Freezer controls are set too low.	See controls section in owner's manual on how to adjust your controls.
	Drawer is improperly positioned.	See section on Crisper drawer to verify drawer positioning.
Refrigerator does not operate	Refrigerator is not plugged in.	Plug in unit.
	Freezer control is not on.	See section on controls in your owner's manual.
	Fuse is blown, or circuit breaker needs to be reset.	Replace any blown fuses. Check circuit breaker and reset if necessary.
	Power outage has occurred	Call local power company listing to report outage.
Refrigerator still won't operate	Unit is malfunctioning.	Unplug refrigerator and transfer food to another unit. If another unit is not available, place dry ice in freezer section to preserve food. Warranty does not cover food loss. Contact service for assistance.
Food temperature is too cold	Condenser coils are dirty.	Clean according to cleaning instructions in your owner's manual.
	Refrigerator or freezer controls are set too high.	See controls section in owner's manual on how to adjust your controls.

Trouble Shooting

OPERATION

TOPIC	POSSIBLE CAUSE	SOLUTION
Food temperature appears too warm	Door is not closing properly.	Refrigerator is not level. See <i>How to Level Your Refrigerator</i> for details on how to level your unit.
		Check gaskets for proper seal. Clean, if necessary, according to cleaning instructions in owner's manual.
		Check for internal obstructions that are keeping door from closing properly (i.e. improperly closed drawers, ice buckets, oversized or improperly stored containers or foodstuffs, etc.).
	Controls need to be adjusted.	See the controls section in your for assistance in how to adjust your controls.
	Condenser coils are dirty.	Clean according to cleaning instructions in your owner's manual.
	Rear air grille is blocked.	Check the positioning of food items in refrigerator to make sure grille is not blocked. Rear air grilles are located under crisper drawers.
Door has been opened frequently, or has been opened for long periods of time.		Reduce time door is open. Organize food items efficiently to assure door is open for as short a time as possible.
		Allow interior environment to adjust for period the door has been open.
Food has recently been added.		Allow time for recently-added food to reach refrigerator or freezer temperature.
Refrigerator has an odor	Compartment is dirty or has odor-causing food.	Refer to <i>Hints and Care</i> in this owner's manual for odor removal instructions.
Water droplets form on outside of refrigerator	Check gaskets for proper seal.	Clean, if necessary, according to cleaning instructions in owner's manual.
	Humidity levels are high.	Normal during times of high humidity.
	Controls require adjustment	See the controls section in your Owner's Manual for assistance in how to adjust your controls.
Water droplets form on inside of refrigerator	Humidity levels are high or door has been opened frequently.	See the controls section in your Owner's Manual for assistance in how to adjust your controls.
	Check gaskets for proper seal.	Reduce time door is open. Organize food items efficiently to assure door is open for as short a time as possible.
		Clean, if necessary, according to cleaning instructions in owner's manual.
Refrigerator or ice maker make unfamiliar sounds or seems too loud	Normal operation	Refer to noise section of troubleshooting guide in owner's manual.
Crisper drawers do not close freely	Contents of drawer, or positioning of items in the surrounding compartment could be obstructing drawer	Reposition food items and containers to avoid interference with the drawers.
	Drawer is not in proper position	See section Crisper drawer section for proper placement.
	Refrigerator is not level.	See <i>How to Level Your Refrigerator</i> for details on how to level your unit.
	Drawer channels are dirty or need treatment.	Clean drawer channels with warm, soapy water. Rinse and dry thoroughly.
Apply a thin layer of petroleum jelly to drawer channels.		
Refrigerator runs too frequently	Doors have been opened frequently or have been opened for long periods of time.	Reduce time door is open. Organize food items efficiently to assure door is open for as short a time as possible.
		Allow interior environment to adjust for period the door has been open.
	Humidity or heat in surrounding area is high.	Normal operation
	Food has recently been added.	Allow time for recently-added food to reach refrigerator or freezer temperature.
	Unit is exposed to heat by environment or by appliances nearby.	Evaluate your unit's environment. Unit may need to be moved to run more efficiently.
Condenser coils are dirty.		Clean according to cleaning instructions in your owner's manual.

Trouble Shooting

OPERATION (continued)

TOPIC	POSSIBLE CAUSE	SOLUTION
Refrigerator runs too frequently (continued)	Controls need to be adjusted.	See controls section in your Owner's Manual for assistance in how to adjust your controls.
	Door is not closing properly.	Refrigerator is not level. See <i>How to Level Your Refrigerator</i> for details on how to level your unit.
		Check gaskets for proper seal. Clean, if necessary, according to cleaning instructions in owner's manual.
		Check for internal obstructions that are keeping door from closing properly (i.e. improperly closed drawers, ice buckets, oversized or improperly stored containers or foodstuffs, etc.).

ICE

Unit is leaking water	Plastic tubing was used to complete water connection.	Amana recommends using copper tubing for installation. Plastic is less durable and can cause leakage. Amana is not responsible for property damage due to improper installation or water connection.
Ice forms in inlet tube to ice maker	Improper water valve was installed.	Check water connection procedure in your <i>Installation Instructions</i> . Self-piercing and $\frac{3}{16}$ " saddle valves cause low water pressure and may clog the line over time. Amana is not responsible for property damage due to improper installation or water connection.
	Water pressure is low.	Water pressure must be between 20 to 100 pounds per square inch to function properly. A minimum pressure of 35 pounds per square inch is recommended for units with water filters.
Water flow is slower than normal	Freezer temperature is too high.	See the controls section in your owner's manual for assistance on how to adjust your controls. Freezer is recommended to be between 0 to 2°F (-18 to -17°C).
	Water pressure is low.	Water pressure must be between 20 to 100 pounds per square inch to function properly. A minimum pressure of 35 pounds per square inch is recommended for units with water filters.
	Improper water valve was installed.	Check water connection procedure in your <i>Installation Instructions</i> . Self-piercing and $\frac{3}{16}$ " saddle valves cause low water pressure and may clog the line over time. Amana is not responsible for property damage due to improper installation or water connection.

Amana Refrigerator Warranty

First Year

Amana will replace, free of charge, any part which is defective due to workmanship or materials.

Second through Fifth Year

Amana will replace free of charge, any sealed system component (compressor, condenser, evaporator, drier and interconnecting tubing) and repair any food compartment liner (exclusive of door liner) which is defective due to workmanship or materials.

Warranty Limitations

- Begins at date of original purchase.
- Excludes original and replacement water or air filter cartridges (if equipped with the filtration system). Original and replacement cartridges are warranted for 30 days, parts only, against defects of material or workmanship.
- Service must be performed by an authorized Amana technician.
- Damage due to shipping and handling is not covered by this warranty.

Warranty Is Void If

Repairs resulting from the following:

- Serial plate is defaced.
- Product is used on a commercial, rental, or leased basis.
- Product has defect or damage due to product accident, alteration, connection to an improper electrical supply, fire, flood, lightning, or other conditions beyond the control of Amana.
- Product is improperly installed or used.

Owner's Responsibility

- Provide proof of purchase (sales receipt).
- Provide normal care and maintenance. Replace owner replaceable items where directions appear in Owner's Manual.
- Make product reasonably accessible for service.
- Pay premium service costs for service outside technician's normal business hours.
- Pay for service calls related to product installation and usage.

Amana Appliances Factory Service

1-800-628-5782 inside USA

For more information, Amana Appliances Consumer Services

Amana Appliances
2800 220th Trail
Amana, Iowa 52204
1-800-843-0304 inside USA
1-866-587-2002 au Canada
www.amana.com

IN NO EVENT SHALL AMANA BE LIABLE FOR INCIDENTAL OR CONSEQUENTIAL DAMAGES.

This warranty gives you specific legal rights, and you may have others which vary from state to state. For example, some states do not allow the exclusion or limitation of incidental or consequential damages, so this exclusion may not apply to you.

Appendix B

Installation and Operating Instructions

IC 11

Bottom Freezer
Refrigerator
Ice Maker Kit

Ordering parts and accessories?
Questions about your features?

Please contact us with your model and serial number:

Consumer Affairs Department
Amana Appliances
2800 - 220th Trail
Amana, Iowa 52204
Ph# 1(800)843-0304
1(319)622-5511 outside U.S.A.
Internet: <http://www.amana.com>

Keep instructions for future reference.

Keep this manual and your sales receipt together in a safe place in case warranty service is required.

Contents

Important Safety Information	3
About Your Ice Maker	4
How the Ice Maker Works	4
How to Use Your Ice Maker	4
Installing Your Ice Maker	5
How to Prepare the Freezer Compartment	6
How to Mount the Water Valve Assembly	6
How to Mount the Ice Maker Kit	7
How to Connect the Water Supply	8
Trouble Shooting	8
Warranty	10



Important Safety Information

What You Need to Know about Safety Instructions

Warning and Important Safety Instructions appearing in this manual are not meant to cover all possible conditions and situations that may occur. Common sense, caution, and care must be exercised when installing, maintaining, or operating refrigerator.

Read entire manual before installing kit. All necessary tools and materials must be available prior to installation. Verify all listed parts are included in kit. If parts are missing, contact source from whom kit was purchased.

- If unable to solve a problem during installation, contact an authorized Amana technician. Locate a factory Service Center or independent authorized technician by calling **1-800-628-5782** inside U.S.A. and **1-319-622-5511** outside U.S.A. Service is at owner's expense.

Before Calling Service...

If something seems unusual, please check "Trouble Shooting" section, which is designed to help you solve problems before calling service.

Recognize Safety Symbols, Words, Labels



DANGER

DANGER—Immediate hazards which **WILL** result in severe personal injury or death.



WARNING

WARNING—Hazards or unsafe practices which **COULD** result in severe personal injury or death.



CAUTION

CAUTION—Hazards or unsafe practices which **COULD** result in minor personal injury or product or property damage.



WARNING

To avoid electrical shock which can cause severe personal injury or death, follow basic precautions, including the following:

- Unplug power cord or open household circuit breaker to refrigerator before installing kit. After installing kit, reconnect power.



CAUTION

To avoid risk of personal injury or property damage, follow basic precautions, including the following:

- Do not place fingers or hands on or around the automatic icemaking mechanism while the refrigerator is plugged in.
- REPLACE ORIGINAL ICE STORAGE BUCKET WITH ONE FROM KIT to avoid spilling ice cubes.
- Confirm water pressure to water valve is between 20 and 100 pounds per square inch. If water filter is installed, water pressure to water valve must be a minimum of 35 pounds per square inch.
- Start nuts by hand to avoid cross threading. Finish tightening nuts using a wrench. Do not over-tighten.
- Check carefully for water leaks prior to returning refrigerator to normal location and 24 hours after connection.

About Your Ice Maker

How the Ice Maker Works

1 Water fills the empty cube mold when the freezer has cooled to freezing temperature. Cold air is forced directly over the mold.

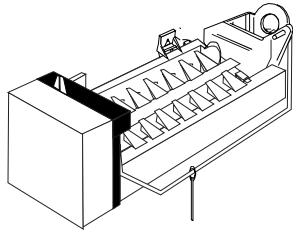

2 When frozen, the cubes are moved up and out of the mold. The sweeper arm (A) ejects them into the ice storage bin (B) below.

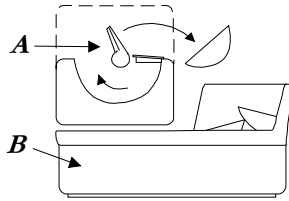

Is it possible for the ice maker to overfill the storage bin ?

The feeler arm (C) senses when the bin (B) is full and signals the icemaker to stop ejecting cubes. The mold refills and freezes a new supply. Once the feeler arm senses that more is needed, the ice maker resumes operation by ejecting the frozen cubes.

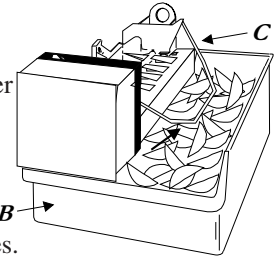

When is it appropriate to shut off my ice maker?

Raise the feeler arm to the STOP (up) position when:

- Ice storage bin is removed, or is being cleaned.
- Refrigerator is not to be used for an extended time, such as vacations. Also, turn off the water supply to the ice maker in this instance.
- Water supply is to be shut off for several hours.

How to Use Your Ice Maker

1 To start ice maker, lower feeler arm to 'on' position.

- Make sure ice storage bin is below ice maker and pushed back as far as possible.

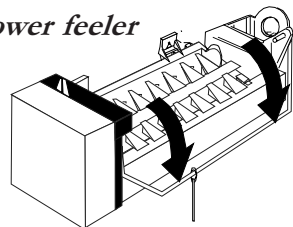

NOTE: Feeler arm must be free to move upward and outward over ice storage bin for ice production. Make sure packages in freezer compartment do not block its movement.

2 Allow approximately 24 hours after installation to receive first harvest of ice.

- Discard ice created within first 12 hours of operation to verify system is flushed of impurities.

My ice cubes have an odor. What can I do to avoid this?

Ice is a porous material and is likely to absorb odors from surrounding areas. Ice cubes that have been in the ice storage bin for a considerable length of time may pick up off-flavor tastes, stick together, and gradually become smaller. We suggest that these cubes be thrown away.

Other ways to control ice cube odor are listed below.

- The ice storage bin should be cleaned occasionally in warm water. Be sure to put the icemaker feeler arm in the STOP (up) position when cleaning the bin. Rinse and wipe dry.
- Check for spoiled or expired items and discard. Wrap all odor-causing foods, or store foods in tightly-sealed containers to prevent odor reoccurrence.
- Water filter (some models) may need to be replaced.
- In some cases, household water quality may need to be checked. If a water filter is desired, a water filter may be ordered for some models. Contact Amana Consumer Affairs for more information on your particular model.

Installing Your Ice Maker

WARNING

To reduce the risk of injury or death, follow basic precautions, including the following:

- Read all instructions before installing device.
- DO NOT attempt installation if instructions are not understood or if they are beyond personal skill level.
- Observe all local codes and ordinances.
- DO NOT service device unless specifically recommended in owner's manual or published user-repair instructions.
- Disconnect power to unit prior to installing device.

CAUTION

To avoid property damage or possible injury, follow basic precautions, including the following:

- Consult a plumber to connect copper tubing to household plumbing to assure compliance with local codes and ordinances.
- Confirm water pressure to water valve is between 20 and 100 pounds per square inch. If water filter is installed, water pressure to water valve must be a minimum of 35 pounds per square inch.
- **DO NOT use a self-piercing, or $\frac{3}{16}$ " saddle valve!** Both reduce water flow, become clogged with time, and may cause leaks if repair is attempted.
- Tighten nuts by hand to prevent cross threading. Finish tightening nuts with pliers and wrenches. Do not overtighten.
- Wait 24 hours before placing unit into final position to check and correct any water leaks.

Materials Needed

- $\frac{1}{4}$ " outer diameter flexible copper tubing

NOTE: Add 8' to tubing length needed to reach water supply for creation of service loop.

- Shut-off valve (requires a $\frac{1}{4}$ " hole to be drilled into water supply before valve attachment)

- Phillips screwdriver
- Needle-nose pliers
- Adjustable wrench
- Flat-blade screwdriver
- $\frac{1}{4}$ " hex nut driver
- Water bucket
- Masking tape or small plastic bag

CONTENTS OF IC-11

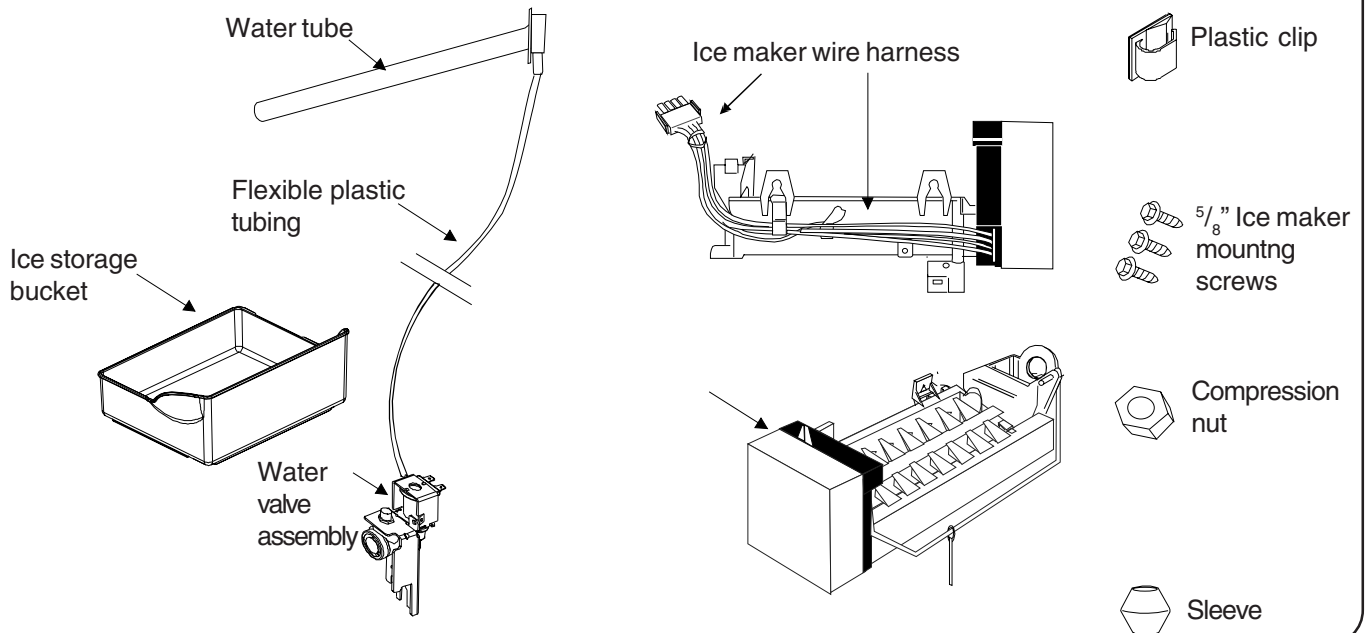

Installing Your Ice Maker

How to Prepare the Freezer Compartment

1 Remove freezer accessories, including all baskets and shelves.

- See Owner's Manual on instructions on removal and replacement of freezer items.

2 Pry water connection cover from top left corner of freezer section with flat blade screwdriver.

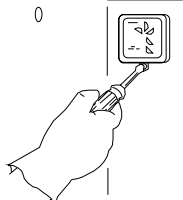

3 Locate water tube inlet cover on back of unit, and pry off with flat-blade screwdriver blade covered with masking tape.

- Discard cover.

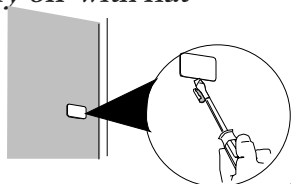

4 From back of refrigerator (A), use screwdriver to pierce interior sealing tape (B) that covers the hole for the water fill tube inlet (C).

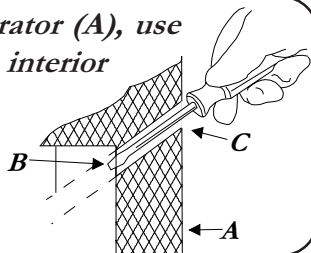

5 Cover end of fill tube (D) with masking tape or small plastic bag to avoid insulation from entering tube during insertion.

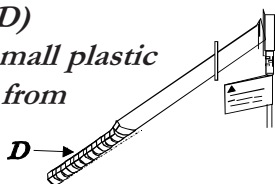

6 Insert fill tube (D) into water fill tube inlet (C).

- If tube does not come through the interior freezer wall, use a pair of needle-nose pliers to pull tube through.

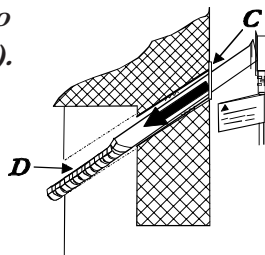

7 Remove tape or plastic bag from the end of the fill tube.

8 From back, push gently on the water fill tube while twisting it slightly. Make sure flange (E) is firmly seated in the hole

- Pull on grommet to be sure that the fit is tight. If tube comes loose, repeat above instructions.

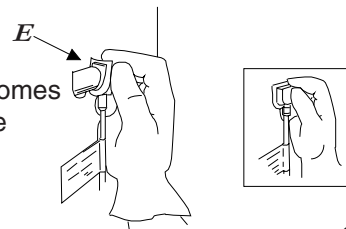

How to Mount the Water Valve Assembly

1 Locate water valve cover plate on back of unit in lower left hand corner. Remove cover plate with a 1/4" hex nut driver.

- Retain screw for later replacement.
- Cut wire tie holding harness to cover plate. Take care not to cut wires.

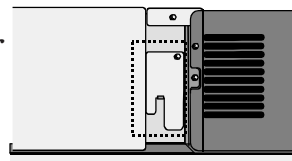

2 Plug harness from inside machine compartment onto water valve electrical terminals.

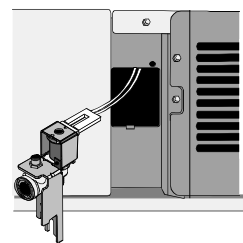

3 Tuck bottom portion of valve inside machine compartment and fasten valve to cabinet with 1/4" screw from step 1.

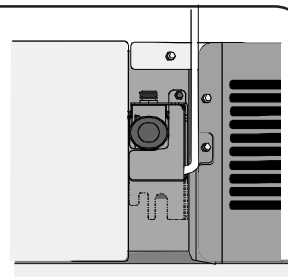

4 Position valve water line as illustrated and secure with small plastic clip (A) located in ice maker kit.

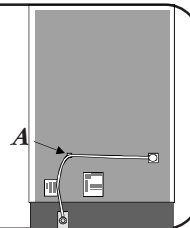

Installing Your Ice Maker

How to Mount the Ice Maker Kit

1 Screw $\frac{5}{8}$ " ice maker mounting screws into holes provided in left wall of freezer section.

- Leave head out approximately $\frac{3}{8}$ " for the slot in the icemaker hanger to slip over the screws.

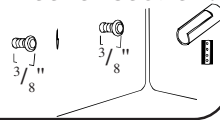

2 Insert wire harness plug into connector on back wall of freezer by using a rocking motion until locking fingers on plug snap into place.

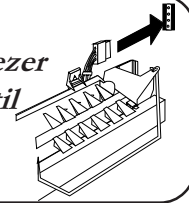

3 Slip fill tube into self-positioning fill tube opening in back of ice maker.

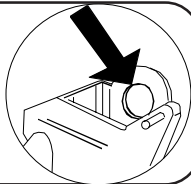

4 Slide ice maker hangers (A) over screws.

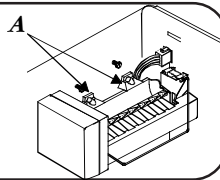

5 Insert remaining mounting screw into bottom of ice maker, and tighten down all mounting screws.

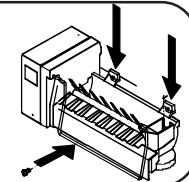

6 Raise feeler arm to the STOP position until water connection is complete.

- Ice make should feel securely mounted.

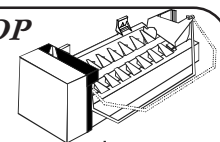

7 Replace baskets and shelves, and place ice storage bin directly under ice maker.

NOTE: Check again to make sure the icemaker power cord is fully inserted into its outlet.

How to Connect the Water Supply

1 Create service loop with tubing and attach to unit with "P" clamp to avoid kinks in tubing.

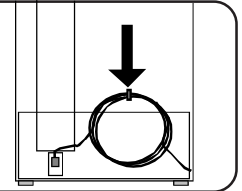

2 Remove plastic cap (A) from water valve inlet port (B).

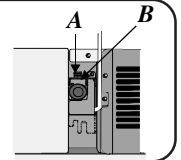

3 Locate water tubing clamp (C) in kit and install with $\frac{1}{4}$ " hex head screw.

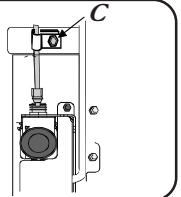

4 Place brass nut (D) and sleeve (E) on copper tube end as illustrated.

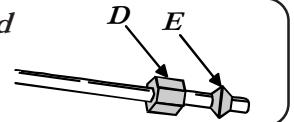

5 Place end of copper tubing into water valve inlet port. Shape tubing slightly—DO NOT KINK—so that tubing feeds straight into inlet port.

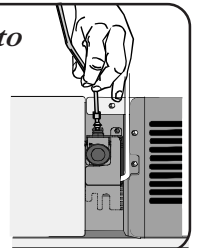

6 Slide brass nut over sleeve and screw nut into inlet port. Tighten nut with wrench.

IMPORTANT: DO NOT overtighten. Cross threading may occur.

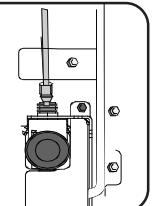

7 Pull on tubing to confirm connection is secure. Connect tubing to frame with water tubing clamp and turn on water supply. Check for leaks and correct, if present.

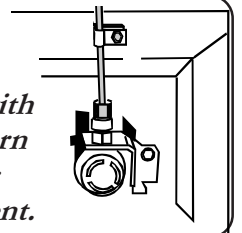

8 Monitor water connection for 24 hours. Correct leaks, if necessary.

Trouble Shooting

TOPIC	POSSIBLE CAUSE	SOLUTION
Ice maker appears to have stopped operating	Ice maker arm is not in correct position	Confirm ice maker arm is down. See <i>Automatic Ice Maker</i> section in your owner's manual for details.
	Electrical power cord may not be plugged into icemaker, or harness is not plugged into water valve.	Make sure plug from power cord fits tightly into wall outlet, or check that connection
	The icemaker is not getting the necessary supply of water.	Make sure the water supply is connected and turned on. Check for kinks in the ¼" copper tubing. Remove kinks or replace tubing if there are kinks. Verify that refrigerator harness is plugged into water valve.
	Freezer temperature is too low	See the controls section in your owner's manual for assistance on how to adjust your controls. Freezer must be between 0 to 2°F (-18 to -17°C) to produce ice.
	The cubes are too small.	The shutoff valve connecting the refrigerator to the home water line may be clogged. Unclog it.
Small or hollow cubes	Water utilizing devices in use elsewhere in house	Avoid operating device such as dishwasher, washing machine or shower.
Ice cubes have odor/taste	Ice stored for an extended period may absorb odors which affect their taste.	Discard old cubes. Use icemaker regularly.
	Ice storage bin needs to be emptied and washed.	Empty and wash ice storage bin.
	Unsealed packages in the refrigerator and/or freezer compartments may be transmitting odor/taste to ice cubes.	Check seals on packages in freezer.
	The interior of the refrigerator needs cleaning.	See <i>Odor Removal</i> instructions in <i>Care and Cleaning Section</i> .
Icemaker is not producing ice	Ice maker arm is not in correct position	Confirm ice maker arm is down. See <i>Automatic Ice Maker</i> section in your owner's manual for details.
	Household water supply is not reaching water valve.	Check water connection procedure in your <i>Installation Instructions</i> .
	Copper or plastic tubing has kinks.	Turn off water supply and remove kinks. If kinks cannot be removed, replace tubing. Amana recommends using a saddle valve. Contact 1-800-843-0304 or an Amana dealer for availability. Do not use self-piercing valve. Amana is not responsible for property damage due to improper installation or water connection.
	Water pressure is too low.	Water pressure must be between 20 to 100 pounds per square inch to function properly. A minimum pressure of 35 pounds per square inch is recommended for units with water filters.
	Freezer temperature is too low.	See the controls section in your owner's manual for assistance on how to adjust your controls. Freezer must be between 0 to 2°F (-18 to -17°C) to produce ice.
	Improper water valve was installed.	Check water connection procedure in your <i>Installation Instructions</i> . Self-piercing and 3/16" saddle valves cause low water pressure and may clog the line over time. Amana is not responsible for property damage due to improper installation or water connection.
	Electrical connection to water valve coil and connector block may be loose.	Check electrical connections to water valve coil and connector block on refrigerator cabinet.

Trouble Shooting

TOPIC	POSSIBLE CAUSE	SOLUTION
Icemaker is not producing ice (some models) (continued from previous page)	Freezer section not operating at proper temperature.	Confirm that freezer section is operating at proper temperature. Adjust accordingly.
Ice maker is not producing enough ice or ice is malformed.	Ice maker has just recently been installed or a large amount of ice has just been used.	Wait 24 hours for ice production to begin and for ice to restock after emptied.
	Water pressure is too low.	Low water pressure can cause valve to leak. Water pressure must be between 20 to 100 pounds per square inch to function properly. A minimum pressure of 35 pounds per square inch is recommended for units with water filters.
	Freezer temperature is too low.	See the controls section in your owner's manual for assistance on how to adjust your controls. Freezer must be between 0 to 2°F (-18 to -17°C) to produce ice.
Ice cubes stick together or "shrink".	Ice cubes have not been emptied.	Empty ice cube bucket or trays more frequently. If used infrequently, ice cubes may stick together or shrink.
Ice forms in inlet tube to ice maker (some models).	Water pressure is too low.	Check water pressure. Low water pressure will cause valve to leak. Self-piercing valves cause low water pressure. Amana recommends using a saddle valve. Contact 1-800-843-0304 or an Amana dealer for availability. Do not use self-piercing valve. Amana is not responsible for property damage due to improper installation or water connection.
	Freezer temperature is too high	See the controls section in your owner's manual for assistance on how to adjust your controls. Freezer is recommended to be between 0 and 2°F (-18 to -17°C).
Unit is leaking water	Plastic tubing was used to complete water connection.	Amana recommends using copper tubing for installation. Plastic is less durable and can cause leakage. Amana is not responsible for property damage due to improper installation or water connection.
	Water pressure is too low.	Low water pressure can cause valve to leak. Water pressure must be between 20 to 100 pounds per square inch to function properly. A minimum pressure of 35 pounds per square inch is recommended for units with water filters.
	Improper water valve was installed	Check water connection procedure in your Installation instructions. Self-piercing and 3/16" saddle valves cause low water pressure and may clog the line over time. Amana is not responsible for property damage due to improper installation or water connection.

For more information on this and other Amana products, visit our Web site

www.amana.com

or

call Consumer Affairs Department at

1-800-843-0304

Ice Maker Full One Year Warranty

First Year

Amana Appliances will repair or replace, free of charge, any part which is defective due to workmanship or materials.

Warranty Limitations

- Begins at date of original purchase.
- Applies to product used within the United States or in Canada if product has Canadian Standards Association listing when shipped from the factory.
- Service must be performed by an authorized Amana® technician.

Warranty Is Void If

- Product is used on a commercial, rental or leased basis.
- Product has defect or damage due to an accident, fire, flood, connection to an improper electrical or water supply, lightning, product alteration, shipping and handling, or other conditions beyond the control of Amana.
- Product is improperly installed or used.

Owner's Responsibilities

- Provide proof of purchase (sales receipt).
- Provide normal care and maintenance. Replace owner replaceable items where directions appear in Owner's Manual and Installation Instruction.
- Make product reasonably accessible for service.
- Pay for premium service costs for service outside technician's normal business hours.
- Pay for service calls related to product installation or customer education.

In no event shall Amana Appliances be liable for incidental or consequential damages.*

*This warranty gives you specific legal rights and you may have others which vary from state to state. For example, some states do not allow the exclusion or limitation of incidental or consequential damages so this exclusion may not apply to you.