



# Service

This manual is to be used by qualified appliance technicians only. Maytag does not assume any responsibility for property damage or personal injury for improper service procedures done by an unqualified person.

## 30" Freestanding Electric Ranges

This Base Manual covers general information  
Refer to individual Technical Sheet  
for information on specific models

This manual includes, but is  
not limited to the following:

**AER4111AA\***  
**AER5511BA\***  
**AER5710BA\***  
**AER5712BA\***  
**AER5722BA\***  
**MER5520AA\***  
**MER5551BA\***  
**MER5552BA\***  
**MER5751BA\***  
**MER5752BA\***  
**MERH752BA\***  
**MERL752BA\***  
**MERL753BA\***  
**MERM752BA\***  
**PERL451AC\***



# Important Information

Pride and workmanship go into every product to provide our customers with quality products. It is possible, however, that during its lifetime a product may require service. Products should be serviced only by a qualified service technician who is familiar with the safety procedures required in the repair and who is equipped with the proper tools, parts, testing instruments and the appropriate service information. **IT IS THE TECHNICIANS RESPONSIBILITY TO REVIEW ALL APPROPRIATE SERVICE INFORMATION BEFORE BEGINNING REPAIRS.**

## Important Notices for Servicers and Consumers



### WARNING

To avoid risk of severe personal injury or death, disconnect power before working/servicing on appliance to avoid electrical shock.

To locate an authorized servicer, please consult your telephone book or the dealer from whom you purchased this product. For further assistance, please contact:

### Customer Service Support Center

CAIR Center

Web Site	Telephone Number
WWW.AMANA.COM .....	1-800-843-0304
WWW.MAYTAG.COM .....	1-800-688-9900
CAIR Center in Canada .....	1-800-688-2002
Amana Canada Product .....	1-800-587-2002

### Recognize Safety Symbols, Words, and Labels



### DANGER

**DANGER**—Immediate hazards which **WILL** result in severe personal injury or death.



### WARNING

**WARNING**—Hazards or unsafe practices which **COULD** result in severe personal injury or death.



### CAUTION

**CAUTION**—Hazards or unsafe practices which **COULD** result in minor personal injury, product or property damage.

# Table of Contents

Important Information .....	2	Disassembly Procedures	
Important Safety Information		Removing and Replacing Range .....	19
Safety Practices for Servicer .....	4	Maintop Assembly (Smoothtop Models) .....	19
Servicing .....	4	Maintop Assembly (Coil Element Models) .....	19
Electrical Requirements .....	5	Control Panel .....	19
Extension Cord .....	5	Control Board Assembly .....	19
Receiving Oven .....	5	Infinite Switch .....	19
Using the Oven .....	5	Indicator Lights .....	19
Baking, Broiling, and Roasting .....	5	Rocker Switch .....	19
Surface Cooking Units .....	6	Convenience Outlet/Circuit Breaker (Canadian Models Only) .....	20
Ovens .....	6	Oven Sensor .....	20
Self-Cleaning Ovens .....	6	Bake Element .....	20
Glass/Ceramic Cooking Surfaces .....	6	Broil Element .....	20
Ventilating Hoods .....	6	Ribbon Elements (select models) .....	20
Precautions .....	6	Coil Element Terminal (select models) .....	20
Product Safety Devices .....	6	Oven Door Latch Assembly (select models) .....	20
General Information		Oven Door(s)	
Cooking Nomenclature .....	7	Oven Door Removal .....	20
Specifications .....	8	Oven Door Hinge Receiver .....	20
Placement of the Oven .....	8	Side Panel Removal .....	21
Do Not Block Air Vents .....	8	Backguard Removal .....	21
Location of Model Number .....	8	Storage Drawer Removal .....	21
Grounding Instructions .....	8	Storage Drawer Track Removal .....	21
Model Identification .....	8	Oven Lamp Assembly Removal .....	21
Service .....	8	Door Disassembly (Standard and Large Windows) .....	22
Parts and Accessories .....	8	Door Disassembly (No Window) .....	23
Extended Service Plan .....	9	Storage Drawer Disassembly .....	24
Range Description .....	9	Appendix A	
Troubleshooting Procedures .....	10	Installation Instructions .....	A-2
Testing Procedures		Appendix B	
Component Testing Procedures .....	12	Use and Care Guide .....	B-2
Control Testing Procedures .....	15		
Quick Test Mode .....	16		

# Important Safety Information

Recognize this symbol as a safety precaution.



## **WARNING**

If the information in this manual is not followed exactly, a fire or explosion may result causing property damage, personal injury or death.

There can be a risk of injury or electrical shock while performing services or repairs. Injury or electrical shock can be serious or even fatal. Consequently, extreme caution should be taken when performing voltage checks on individual components of a product. The electrical power supply should ALWAYS be disconnected when servicing a product.

This appliance must be properly grounded. Never plug in or direct-wire an appliance unless it is properly grounded and in accordance with all local and national codes. See "Installation Instructions" that accompany the product for the appropriate grounding procedures.

### **GROUND PATH SPECIFICATIONS:**

Ground Path Resistance: 0.1 ohms maximum  
Insulation Resistance: 250k ohms minimum

## **WARNING**

To avoid risk of electrical shock, property damage, personal injury or death; verify wiring is correct, if components were replaced. Verify proper and complete operation of unit after servicing.

This appliance contains or produces a chemical or chemicals which are known to the state of California to cause cancer, birth defects or other reproductive harm. To reduce the risk from substances in the fuel or from fuel combustion, make sure this appliance is installed, operated, and maintained according to the instructions in this manual.

**TO REDUCE THE RISK OF TIPPING OF THE RANGE, THE RANGE MUST BE SECURED BY PROPERLY INSTALLED ANTI-TIP DEVICES.**



## **WARNING**

### **In Case of Fire**

Fires can occur as a result of over cooking or excessive grease. Though a fire is unlikely, proceed as follows:

#### **Surface Element Fires**

1. Smother fire with a nonflammable lid/baking soda, or use a Class ABC or BC extinguisher. Not water, salt or flour.
2. As soon as it is safe to do so, turn the surface controls to "OFF."

#### **Oven Fires**

1. Do not open the oven door.
2. Turn all controls to the OFF position.
3. As an added precaution turn off the electricity at the main circuit breaker or fuse box.
4. Turn on vent to remove smoke.
5. Allow the food or grease to burn itself out in the oven.
6. If smoke and fire persist, call the local fire department.
7. If there is any damage to components, call an authorized servicer before using range.

To avoid risk of property damage or personal injury, do not obstruct the flow of combustion or ventilation air to the oven.

To avoid risk of electrical shock, serious personal injury or death: Verify the oven has been properly grounded and always disconnect the electrical supply before servicing this unit.

### **Safety Practices for Servicer**

Safe and satisfactory operation of electrical ranges depends upon its design and proper installation.

### **Servicing**

Listed below are some general precautions and safety practices which should be followed in order to protect the service technician and consumer during service and after service has been completed.

1. **Check range when service is complete**—After servicing, make visual checks on electrical connection. Inform consumer of the condition of range before leaving.
2. **Adhere to all local regulations and codes when performing service.**

# Important Safety Information

## Electrical Requirements

240-volt, 60 Hertz, 40 amp, individual circuit which is properly grounded, polarized and protected by a circuit breaker or fuse.

## Extension Cord

Due to possible pinching during installation, extension cords should not be used on products.

## Receiving Oven

- Authorized servicer must install the range, in accordance with the Installation Instructions. Adjustments and service should be performed only by authorized servicer.
- Plug range into a 240-volt grounded outlet only. Do not remove round grounding prong from the plug. If in doubt about grounding of the home electrical system, it is consumers responsibility and obligation to have an ungrounded outlet replaced with a properly grounded three-prong outlet in accordance with the National Electrical Code. Do not use an extension cord with this appliance.
- Insure all packing materials are removed from the range before operating it, to prevent fire or smoke damage should the packing material ignite.
- With prolonged use of a range, high floor temperatures could result. Many floor coverings will not be able to withstand this kind of use. Never install range over vinyl tile or linoleum that cannot withstand high temperatures. Never install range directly over carpeting.

## Using the Oven

- Do not leave children alone or unattended where a range is hot or in operation. They could be seriously burned.
- Do not allow anyone to climb, stand or hang on the door. They could damage the range and cause severe personal injury.
- Wear proper apparel. Loose fitting or hanging garments should never be worn when using oven. Flammable material could ignite if brought in contact with hot oven surfaces which may cause severe burns.
- Never use range for warming or heating a room. This may cause burns, injuries, or a fire.
- Do not use water on grease fires.
- Do not let grease or other flammable materials collect in or around range.
- Do not repair or replace any part of range unless it is recommended in this manual.
- Use only dry potholders. Moist or damp potholders used on hot surfaces may result in a burn from steam. Do not use a towel or a bulky cloth as a potholder.
- Never leave range unattended while cooking. Boilovers can cause smoking and may ignite.

- Only certain types of glass/ceramic, earthenware, or other glazed utensils are suitable for oven use. Unsuitable utensils may break due to sudden temperature change.
- Use care when opening oven door. Let hot air or steam escape before removing or replacing food.
- Do not heat unopened food containers in oven. Buildup of pressure may cause a container to burst and result in injury.
- Keep range vent ducts unobstructed.
- Place oven racks in desired location while oven is cool. If a rack must be moved while oven is hot, use a dry potholder.
- Do not use aluminum foil to line oven bottom or racks. Aluminum foil can cause a fire and will seriously affect baking results, and damage to porcelain surfaces.
- Do not touch interior surfaces of oven during or immediately after use. Do not let clothing or other flammable materials come in contact with bake or broil elements.
- Other areas of the oven can become hot enough to cause burns, such as vent openings, window, oven door and oven racks.
- To avoid steam burns, do not use a wet sponge or cloth to wipe up spills on hot cooking area.
- Do not store combustible or flammable materials, such as gasoline or other flammable vapors and liquids near or in oven.
- Do not clean oven door gasket located on back of the door. Gasket is necessary to seal the oven and can be damaged as a result of rubbing or being moved.
- Do not drape towels or any materials on oven door handles. These items may ignite causing a fire.



### CAUTION

Do not store items of interest to children in cabinets above range. Children may climb on oven to reach these items and become seriously injured.

## Baking, Broiling, and Roasting

- Do not use oven area for storage.
- Stand back from range when opening a hot oven door. Hot air or steam can cause burns to hands, face, and eyes.
- Use only glass cookware appropriate for use in electric ovens.
- Always remove broiler pan from oven when finished broiling. Grease left in pan can catch fire if oven is used without removing grease from the broiler pan.
- Make sure broiler pan is placed correctly to reduce any possibility of grease fires.
- Should a grease fire occur in the broiler pan, turn off oven, and keep oven door closed until fire burns out.

# Important Safety Information

## Surface Cooking Units

1. Use Proper Pan Size—This appliance is equipped with one or more surface units of different size. Select utensils having flat bottoms large enough to cover the surface unit heating element. The use of undersized utensils will expose a portion of the heating element to direct contact and may result in ignition of clothing. Proper relationship of utensil to burner will also improve efficiency.
2. Never Leave Surface Units Unattended—Boilover causes smoking/greasy spillovers that may ignite.
3. Make Sure Reflector Pans or Drip Bowls Are In Place—Absence of these pans or bowls during cooking may subject wiring or components underneath to damage.
4. Protective Liners—Do not use aluminum foil to line oven bottom. Improper installation of these liners may result in a risk of electrical shock or fire.
5. Glazed Cooking Utensils—Do not use glass, ceramic, earthenware or other glazed utensils. They can damage or break smoothtop due to sudden change in temperature.
6. Utensil Handles Should be Turned Inward and Not Extend Over Adjacent Surface Units—To reduce the risk of burns, ignition of flammable materials, and spillage due to unintentional contact with the utensil, the handle of a utensil should be turned inward, and does not extend over adjacent surface units.
7. Do Not Soak Removable Heating Elements—Heating elements should never be immersed in water.

## Ovens

1. Use Care When Opening Door—Let hot air or steam escape before removing or replacing food.
2. Do Not Heat Unopened Food Containers—Buildup of pressure may cause container to burst and result in injury.
3. Keep Oven Vent Ducts Unobstructed.
4. Placement of Oven Racks—Always place oven racks in desired location while oven is cool. If rack is removed while oven is hot, do not let potholder contact hot heating element in oven.

## Self-Cleaning Ovens

1. Do Not Clean Door Gasket—The door gasket is essential for a good seal. Care should be taken not to rub, damage or move the gasket.
2. Do Not Use Oven Cleaners—No commercial oven cleaner or oven liner protective coating of any kind should be used in or around any part of the oven.
3. Clean Only Parts Listed in Manual.
4. Before Self-Cleaning the Oven—Remove broiler pan and other utensils.

## Glass/Ceramic Cooking Surfaces

1. Do Not Cook on Broken Cooktop—If cooktop should break, cleaning solutions and spillovers may penetrate the broken cooktop and create a risk of electric shock. Contact a qualified technician immediately.
2. Clean Cooktop with Caution—If a wet sponge or cloth is used to wipe spills on a hot cooking area, be careful to avoid steam burn. Some cleaners can produce noxious fumes if applied to a hot surface.

## Ventilating Hoods

1. Clean Ventilating Hoods Frequently—Grease should not be allowed to accumulate on hood or filter.
2. When flaming foods under the hood, turn the fan off. The fan, if operating, may spread the flame.

## Precautions

- Do not cook food directly on range top surface, always use cookware.
- Do not mix household cleaning products. Chemical mixtures may interact with hazardous results.
- Do not put plastic items on warm cooking areas.
- Do not slide rough objects across range top surface.
- Do not leave fat heating unless you remain nearby. Fat can ignite if overheated by spilling onto hot surfaces.
- Do not allow pots to boil dry as this can cause damage to cooking surface and pan.
- Do not use range top surface as a cutting board.

## Product Safety Devices

Safety devices and features have been engineered into the product to protect consumer and servicer. Safety devices must never be removed, bypassed, or altered in such a manner as to defeat the purpose for which they were intended.

### Grounded Oven Frame

Ground prong on power cord is connected to the frame, usually a green lead fastened by a screw. Any part or component capable of conducting an electric current is grounded by its mounting.

If any ground wire, screw, strap, nut, etc. is removed for service, it must be reconnected to its original position with original fastener before the range is put into operation. Failure to do so can create a possible shock hazard.

# General Information

This manual provides basic instructions and suggestions for handling, installing and servicing electric ranges.

The directions, information, and warnings in this manual are developed from experience and careful testing of the product. If the unit is installed according to this manual, it will operate properly and will require minimal servicing. A unit in proper operating order ensures the consumer all the benefits provided by clean, modern electric cooking.

This manual contains information needed by authorized service technicians to install and service electric ranges.

There may be, however, some parts which need further explanation. Refer to the Installation Instructions, Use and Care, Technical Sheets or the toll-free technical support line.

## Cooking Nomenclature

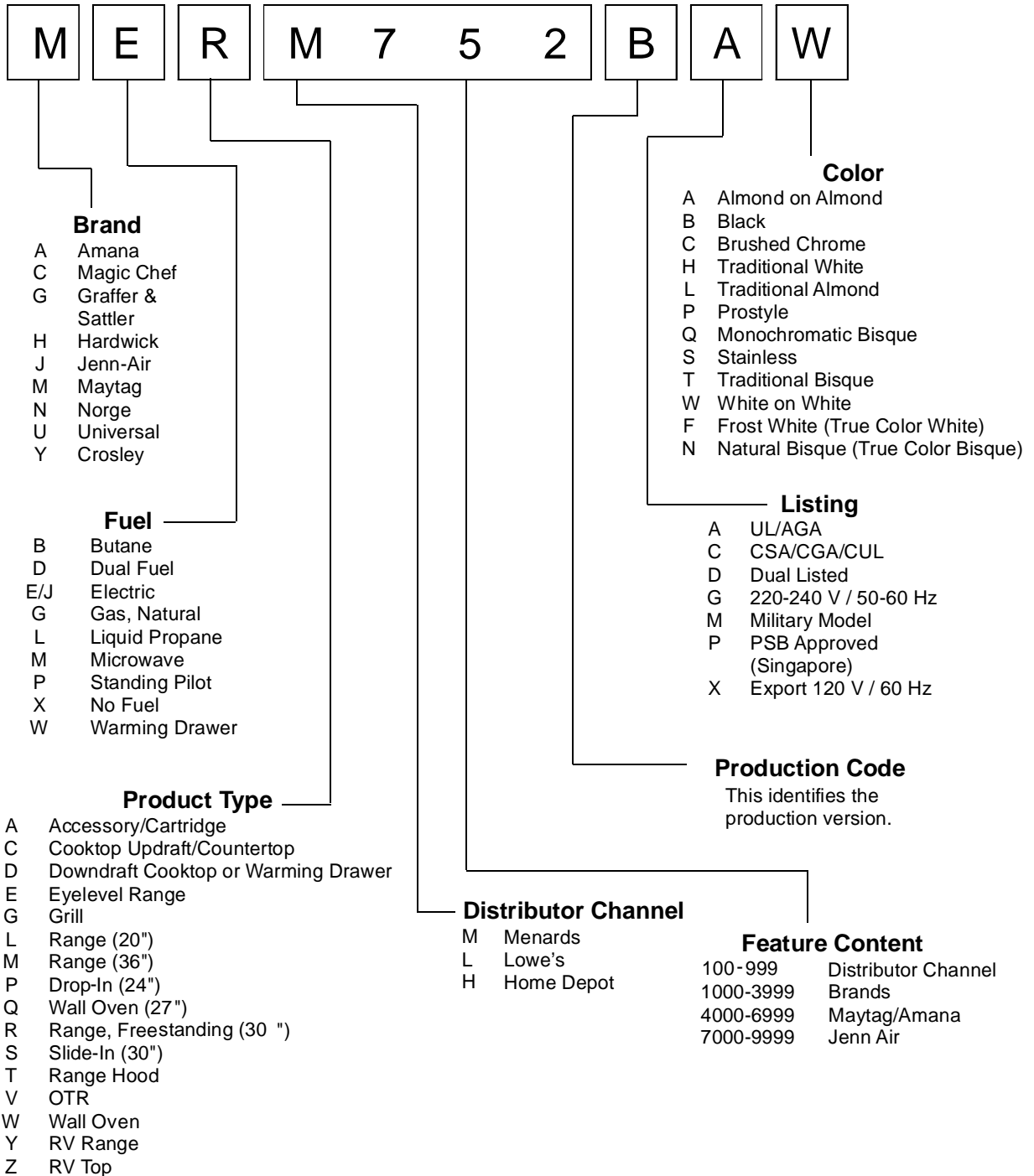

# General Information

## Specifications

Refer to individual Technical Sheet for specification information.

## Placement of the Oven

This freestanding range must be placed in the kitchen or comparable room. All safety guidelines must be followed (see Chapter 2) and free air flow around the range is essential.

## Do Not Block Air Vents

All air vents must be kept clear during cooking. If air vents are covered during operation, the oven may overheat. If this occurs, a sensitive, thermal safety device automatically removes power to the oven, rendering the oven inoperable. The oven will remain in this state until it has sufficiently cooled.

## Location of Model Number

To request service information or replacement parts, the service center will require the complete model, serial, and manufacturing number of your freestanding range. The number can be found on the oven chassis behind the service drawer. Open the service drawer to view the data.

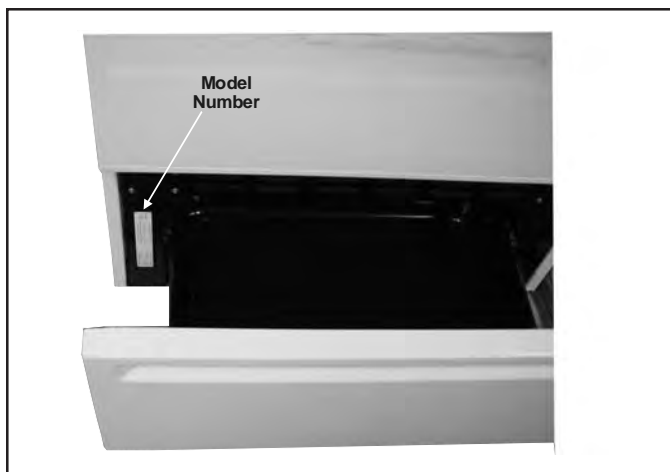

## Grounding Instructions

This appliance must be grounded. If an electrical short circuit occurs, grounding reduces the risk of electric shock by providing an escape wire for the electric current. The cord for this appliance has a grounding wire with a grounding plug. Put the plug into an outlet that is properly installed and grounded.

 <b>WARNING</b>
To avoid risk of electric shock, personal injury or death, use grounding plug properly.

Ask a qualified electrician if you do not understand the grounding instructions or if you wonder whether the appliance is properly grounded. Keep the electrical power cord dry and do not pinch or crush it in any way.

For a permanently connected appliance: This appliance must be connected to a grounded, metallic, permanent wiring system, or an equipment grounding conductor with circuit conductors, and connected to the equipment grounding terminal or lead on the appliance.

 <b>WARNING</b>
Attaching adapter ground terminal to wall receptacle cover screw does not ground appliance unless the cover screw is metal and not insulated, and wall receptacle is grounded through the house wiring. Consumer should have circuit checked by a qualified electrician to verify receptacle is properly grounded.

## Model Identification

Complete enclosed registration card and promptly return. If registration card is missing:

- For Amana product call 1-800-843-0304 or visit the web site at [www.amana.com](http://www.amana.com)
- For Maytag product call 1-800-688-9900 or visit the web site at [www.maytag.com](http://www.maytag.com)
- For product in Canada call 1-866-587-2002 or visit the web sites at [www.maytag.com](http://www.maytag.com) or [www.amana.com](http://www.amana.com)

When contacting Maytag service, provide product information located on rating plate. Record the following:

Model Number: \_\_\_\_\_  
Manufacturing Number: \_\_\_\_\_  
Serial or S/N Number: \_\_\_\_\_  
Date of purchase: \_\_\_\_\_  
Dealer's name and address: \_\_\_\_\_

## Service

Keep a copy of sales receipt for future reference or in case warranty service is required. To locate an authorized servicer:

- For Amana product call 1-800-628-5782 or visit the web site at [www.amana.com](http://www.amana.com)
  - For Maytag product call 1-800-462-9824 or visit the web site at [www.maytag.com](http://www.maytag.com)
  - For product in Canada call 1-866-587-2002 or visit the web sites at [www.maytag.com](http://www.maytag.com) or [www.amana.com](http://www.amana.com)
- Warranty service must be performed by an authorized servicer. We also recommend contacting an authorized servicer, if service is required after warranty expires.

## Parts and Accessories

Purchase replacement parts and accessories over the phone. To order accessories for your product:

- For Amana product, call 1-877-232-6771 or visit the web site at [www.amana.com](http://www.amana.com)
- For Maytag product, call 1-800-462-9824 or visit the web site at [www.maytag.com](http://www.maytag.com)
- For product in Canada call 1-866-587-2002 or visit the web sites at [www.amana.com](http://www.amana.com) or [www.maytag.com](http://www.maytag.com)



# Range Description

## Extended Service Plan

We offer long-term service protection for this new oven.

- Asure™ Extended Service Plan is specially designed to supplement Amana's strong warranty. This plan covers parts, labor, and travel charges. Call 1-866-232-6244 for information.

- Dependability Plus<sup>SM</sup> Extended Service Plan is specially designed to supplement Maytag's strong warranty. This plan covers parts, labor, and travel charges. Call 1-800-925-2020 for information.

## Range Description

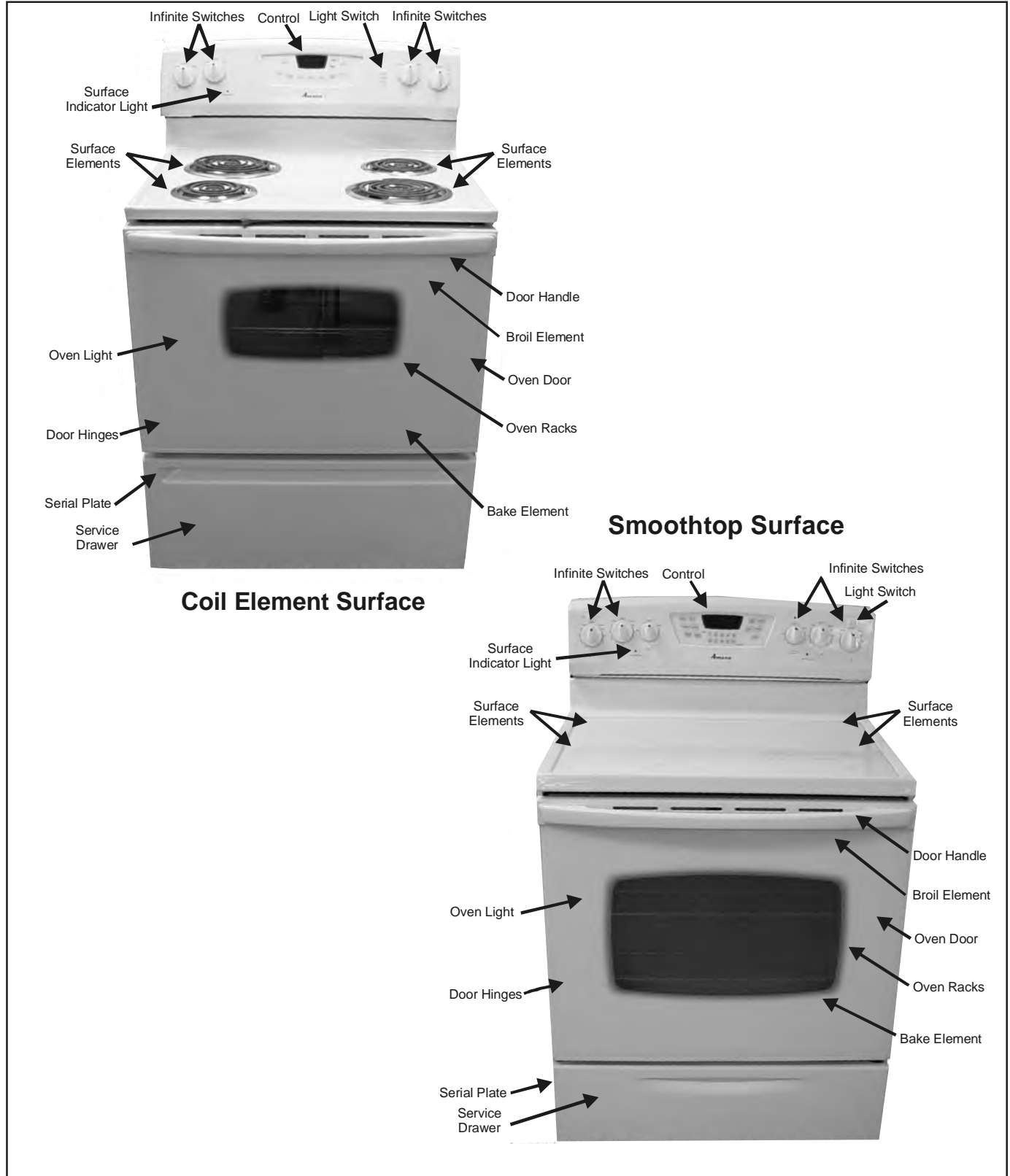

# Troubleshooting Procedures



To avoid risk of electrical shock, personal injury, or death, disconnect power to range before servicing, unless testing requires power.

Problem	Possible Cause	Correction
No bake element operation	Open bake element..... Loose wire connection or broken wire .....	<ul style="list-style-type: none"> <li>• Check element for continuity, replace if failed.</li> <li>• Verify all connections are clean and tight, replace broken wire.</li> </ul>
No broil element operation	Open broil element..... Loose wire connection or broken wire .....	<ul style="list-style-type: none"> <li>• Check element for continuity, replace if failed.</li> <li>• Verify all connections are clean and tight, replace broken wire.</li> </ul>
Oven not operating	Programming error ..... Power outage .....	<ul style="list-style-type: none"> <li>• Shut off power to oven for five minutes by switching circuit breaker off. Reset circuit breaker and try oven again.</li> <li>• Verify power is present at unit. Verify that the circuit breaker is not tripped.</li> <li>• Replace household fuse, but do not fuse capacity.</li> </ul>
Clock and timer not working	Power outage .....	<ul style="list-style-type: none"> <li>• Verify power is present at unit. Verify that the circuit breaker is not tripped.</li> <li>• Replace household fuse, but do not fuse capacity.</li> <li>• Refer to Use and Care Manual "Operating Instructions", if continues contact service.</li> </ul>
Oven light does not operate	Failed oven lamp..... Failed wiring..... Failed light socket .....	<ul style="list-style-type: none"> <li>• Check lamp and replace is necessary.</li> <li>• Check for broken, loose or dirty connections.</li> <li>• Check light socket for continuity.</li> </ul>
Self-clean cycle not working	Programming error .....	<ul style="list-style-type: none"> <li>• Shut off power to oven for five minutes by switching off circuit breaker. Reset circuit breaker and try oven again.</li> </ul>
Oven door will not unlock	Oven is self-cleaning..... Oven is still hot.....	<ul style="list-style-type: none"> <li>• Allow cycle to complete.</li> <li>• Will not unlock until unit has cooled to safe temperature. Do not force door open, this will void warranty. Blow cool air on door latch area to quicken process.</li> </ul>
Oven smokes/odor first few times of usage	Normal.....	<ul style="list-style-type: none"> <li>• Minor smoking or odor is normal the first few times of oven usage.</li> <li>• Ventilate area well and perform self-clean cycle.</li> </ul>
Failure Codes	Electronically Controlled .....	<ul style="list-style-type: none"> <li>• Refer to specific Technical Sheet for diagnostic checks.</li> </ul>

# Troubleshooting Procedures



## WARNING





To avoid risk of electrical shock, personal injury, or death, disconnect power to range before servicing, unless testing requires power.

Problem	Possible Cause	Correction
Surface element does not heat	Open element ..... Loose wire connection or broken wire ..... Failed infinite switch.....	<ul style="list-style-type: none"> <li>• Check element for continuity, replace if failed.</li> <li>• Verify all connections are clean and tight, replace broken wiring.</li> <li>• Check infinite switch, replace if failed.</li> </ul>
Frequent cycling of surface element or warming zone	Normal .....	<ul style="list-style-type: none"> <li>• Element cycles to maintain proper heat and to prevent damage to smoothtop.</li> </ul>

# Component Testing Procedures

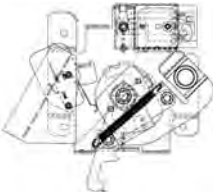
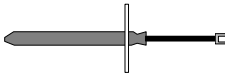
## ⚠ WARNING

To avoid risk of electrical shock, personal injury or death; disconnect power to range before servicing, unless testing requires power.

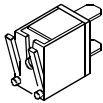
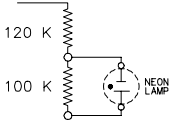
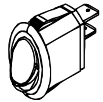
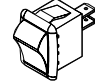
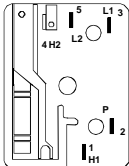
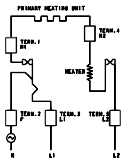
Illustration	Component	Test Procedure	Results
	Oven light socket (select models)	Measure voltage at oven light ..... Remove one wire from receptacle and test resistance of terminals .....	120 VAC, see wiring diagram for terminal identification. Continuity with bulb inserted. If voltage is not present at oven light, check wiring or light switches.
	Manual latch assembly with switch (select models)	Disconnect wires and test for continuity per wiring diagram .....	See wiring diagram for schematic layout. Refer to Parts Manual for replacement components. <b>NOTE:</b> If latch is moved to LOCK position during Bake or Broil, the control cancels the function.
	Oven temperature sensor	Measure resistance.....	Approximately 1000 $\Omega$ at room temperature 80° F.
	Bake element (select models)	Disconnect wire leads to element and measure resistance of terminals ..... Measure voltage at bake element .....	Approximately 20.5 to 22.8 $\Omega$ . 240 VAC, see wiring diagram for terminal identification. If no voltage is present at bake element, check wiring.
	Bake element (select models)	Disconnect wire leads to element and measure resistance of terminals ..... Measure voltage at bake element .....	Approximately 20.6 to 22.6 $\Omega$ . 240 VAC, see wiring diagram for terminal identification. If voltage is not present at bake element, check wiring.
	Broil element (select models)	Disconnect wire leads to element and measure resistance of terminals ..... Measure voltage at broil element .....	Approximately 17.7 to 19.5 $\Omega$ . 240 VAC, see wiring diagram for terminal identification. If voltage is not present at broil element, check wiring.
 	Indicator light (select models)	Measure voltage at indicator light.....	240 VAC If voltage is present and light does not work, replace light. If voltage is not present at indicator light, check wiring.
	Rocker switch (select models)	Measure continuity of switch positions: Closed ..... Open.....	Continuity Infinite
	Rocker switch (select models)	Measure continuity of switch positions: Closed ..... Open.....	Continuity Infinite
 	Infinite switch (select models)	Connect volt-ohms meter to H1 and H2.  Measure the following for voltages at LO, MED, HI: H1 to H2 .....	<b>Approximate</b> <b>Time On      Time Off</b> LO            5%            95% MED (4-5)   35%           65% HI            100%          0%  240 VAC. If not, replace switch.

# Component Testing Procedures



## WARNING

To avoid risk of electrical shock, personal injury or death; disconnect power to range before servicing, unless testing requires power.

Illustration	Component	Test Procedure	Results												
	Infinite switch (select models) 	Connect volt-ohms meter to H1 and H2.  Measure the following for voltages at LO, MED, HI: H1 to H2.....	<b>Approximate</b> <table border="1"> <thead> <tr> <th></th> <th>Time On</th> <th>Time Off</th> </tr> </thead> <tbody> <tr> <td>LO</td> <td>5%</td> <td>95%</td> </tr> <tr> <td>MED (4-5)</td> <td>35%</td> <td>65%</td> </tr> <tr> <td>HI</td> <td>100%</td> <td>0%</td> </tr> </tbody> </table> 240 VAC. If not, replace switch.		Time On	Time Off	LO	5%	95%	MED (4-5)	35%	65%	HI	100%	0%
	Time On	Time Off													
LO	5%	95%													
MED (4-5)	35%	65%													
HI	100%	0%													
	Infinite switch (select models) 	Connect volt-ohms meter to 2 and 4.  Measure the following for voltages at LO, MED, HI: 2 to 4.....	<b>Approximate</b> <table border="1"> <thead> <tr> <th></th> <th>Time On</th> <th>Time Off</th> </tr> </thead> <tbody> <tr> <td>LO</td> <td>5%</td> <td>95%</td> </tr> <tr> <td>MED (4-5)</td> <td>35%</td> <td>65%</td> </tr> <tr> <td>HI</td> <td>100%</td> <td>0%</td> </tr> </tbody> </table> 240 VAC. If not, replace switch.		Time On	Time Off	LO	5%	95%	MED (4-5)	35%	65%	HI	100%	0%
	Time On	Time Off													
LO	5%	95%													
MED (4-5)	35%	65%													
HI	100%	0%													
	Infinite switch (select models) 	Connect volt-ohms meter to H1 and H2.  Measure the following for voltages at LO, MED, HI: H1 to H2.....	<b>Approximate</b> <table border="1"> <thead> <tr> <th></th> <th>Time On</th> <th>Time Off</th> </tr> </thead> <tbody> <tr> <td>LO</td> <td>5%</td> <td>95%</td> </tr> <tr> <td>MED (4-5)</td> <td>35%</td> <td>65%</td> </tr> <tr> <td>HI</td> <td>100%</td> <td>0%</td> </tr> </tbody> </table> 240 VAC. If not, replace switch.		Time On	Time Off	LO	5%	95%	MED (4-5)	35%	65%	HI	100%	0%
	Time On	Time Off													
LO	5%	95%													
MED (4-5)	35%	65%													
HI	100%	0%													
	Infinite switch (select models) 	Connect volt-ohms meter to H1 and H2.  Measure the following for voltages at LO, MED, HI: H1 to H2.....	<b>Approximate</b> <table border="1"> <thead> <tr> <th></th> <th>Time On</th> <th>Time Off</th> </tr> </thead> <tbody> <tr> <td>LO</td> <td>6%</td> <td>94%</td> </tr> <tr> <td>MED (4-5)</td> <td>40%</td> <td>60%</td> </tr> <tr> <td>HI</td> <td>100%</td> <td>0%</td> </tr> </tbody> </table> 240 VAC. If not, replace switch.		Time On	Time Off	LO	6%	94%	MED (4-5)	40%	60%	HI	100%	0%
	Time On	Time Off													
LO	6%	94%													
MED (4-5)	40%	60%													
HI	100%	0%													
	Infinite switch (select models) Internal circuit diagram in OFF position 	Connect volt-ohms meter to H1 and H2.  Measure the following for voltages at LO, MED, HI: 2 to 4.....	<b>Approximate</b> <table border="1"> <thead> <tr> <th></th> <th>Time On</th> <th>Time Off</th> </tr> </thead> <tbody> <tr> <td>LO</td> <td>5%</td> <td>95%</td> </tr> <tr> <td>MED (4-5)</td> <td>35%</td> <td>65%</td> </tr> <tr> <td>HI</td> <td>100%</td> <td>0%</td> </tr> </tbody> </table> 240 VAC. If not, replace switch.		Time On	Time Off	LO	5%	95%	MED (4-5)	35%	65%	HI	100%	0%
	Time On	Time Off													
LO	5%	95%													
MED (4-5)	35%	65%													
HI	100%	0%													
	Infinite switch (select models) 	Connect volt-ohms meter to H1 and H2.  Measure the following for voltages at LO, MED, HI: H1 to H2	<b>Approximate</b> <table border="1"> <thead> <tr> <th></th> <th>Time On</th> <th>Time Off</th> </tr> </thead> <tbody> <tr> <td>LO</td> <td>5%</td> <td>95%</td> </tr> <tr> <td>MED (4-5)</td> <td>35%</td> <td>65%</td> </tr> <tr> <td>HI</td> <td>100%</td> <td>0%</td> </tr> </tbody> </table> 240 VAC. If not, replace switch.		Time On	Time Off	LO	5%	95%	MED (4-5)	35%	65%	HI	100%	0%
	Time On	Time Off													
LO	5%	95%													
MED (4-5)	35%	65%													
HI	100%	0%													
	Thermostat (select models) 	Measure thermostat for continuity.....	See wiring diagram.												
	Backguard outlet circuit breaker (Canadian models)	Measure continuity between terminals: Plunger closed (pushed in)..... Plunger open (pulled out).....	Continuity Infinite												

# Component Testing Procedures



## WARNING

To avoid risk of electrical shock, personal injury or death; disconnect power to range before servicing, unless testing requires power.

Illustration	Component	Test Procedure	Results
	Coil element, 4-turn 1500 W (select models)	Disconnect wire leads to element and measure resistance of terminals ..... Measure voltage at coil element.....	Approximately 35.5 to 39.1 $\Omega$ . 240 VAC, see wiring diagram for terminal identification. If voltage is not present at element, check wiring.
	Coil element, 5-turn 2350 W (select models)	Disconnect wire leads to element and measure resistance of terminals ..... Measure voltage at coil element.....	Approximately 22.6 to 25 $\Omega$ . 240 VAC, see wiring diagram for terminal identification. If voltage is not present at element, check wiring.
	Coil element, 4-turn 1250 W (select models)	Disconnect wire leads to element and measure resistance of terminals ..... Measure voltage at coil element.....	Approximately 42.4 to 47 $\Omega$ . 240 VAC, see wiring diagram for terminal identification. If voltage is not present at element, check wiring.
	Coil element, 5-turn 2100 W (select models)	Disconnect wire leads to element and measure resistance of terminals ..... Measure voltage at coil element.....	Approximately 25.3 to 27.9 $\Omega$ . 240 VAC, see wiring diagram for terminal identification. If voltage is not present at element, check wiring.
	Ribbon element, 1200W (select models)	Disconnect wire leads to element and measure cold resistance of terminals ..... Measure voltage at element.....	Approximately 44.3 to 48.9 $\Omega$ . 240 VAC. If voltage is not present, check wiring.
	Ribbon element, dual, 2400W Inner: .... 1100W Outer: .... 1300W (select models)	Disconnect wire leads to element and measure cold resistance of terminals ..... Measure voltage at element.....	Inner: ... Approximately 51 $\Omega$ . Outer: .. Approximately 43 $\Omega$ . 240 VAC. If voltage is not present, check wiring.
	Ribbon element, 2500W (select models)	Disconnect wire leads to element and measure cold resistance of terminals ..... Measure voltage at element.....	Approximately 21.3 to 23.5 $\Omega$ . 240 VAC. If voltage is not present, check wiring.
	Ribbon element, ceramas, 2700W (select models)	Disconnect wire leads to element and measure cold resistance of terminals ..... Measure voltage at element.....	Approximately 19.4 to 22 $\Omega$ . 240 VAC. If voltage is not present, check wiring.
	Ribbon element, ceran, 100W (select models)	Disconnect wire leads to element and measure cold resistance of terminals ..... Measure voltage at element.....	Approximately 133.3 to 147.3 $\Omega$ . 240 VAC. If voltage is not present, check wiring.
	Ribbon element, ceramas, 2700W (select models)	Disconnect wire leads to element and measure cold resistance of terminals ..... Measure voltage at element.....	Approximately 19.4 to 22 $\Omega$ . 240 VAC. If voltage is not present, check wiring.
	Coil element, 3-turn 1250 W (select models)	Disconnect wire leads to element and measure resistance of terminals ..... Measure voltage at coil element.....	Approximately 42.5 to 46.9 $\Omega$ . 240 VAC, see wiring diagram for terminal identification. If voltage is not present at element, check wiring.
	Coil element, 4-turn 2100 W (select models)	Disconnect wire leads to element and measure resistance of terminals ..... Measure voltage at coil element.....	Approximately 33 to 38 $\Omega$ . 240 VAC, see wiring diagram for terminal identification. If voltage is not present at element, check wiring.

# Control Testing Procedures



## WARNING

To avoid risk of electrical shock, personal injury or death; disconnect power to range before servicing, unless testing requires power.

Control	Feature	Test Procedure	Results
M1	Oven temperature adjustment	Press <b>Bake</b> pad. Enter <b>550</b> on the digit-pad. Immediately press and hold <b>Bake</b> pad for 3 to 5 seconds.  Oven can be adjusted from -35 to +35 degrees in 5-degree increments by pressing <b>More +</b> or <b>Less -</b> pads. To avoid over adjusting the oven, move temperature 5 degrees each time. Wait 4 seconds for the data entry timer to expire to accept the change. Temperature adjustment will be retained even through a power failure.	While increasing or decreasing oven temperature, this does not affect self-cleaning temperature.
M1	Temperature display	Press and hold <b>Cancel</b> and <b>Bake</b> pads for 3 to 5 seconds. Press <b>More +</b> or <b>Less -</b> pads to change.	This mode enables the user to indicate °F or °C on the display.
M1	Clock display	Press and hold <b>Cancel</b> and <b>Clock</b> pads for 3 to 5 seconds.	Allows clock to be toggled on or off.
M1	24-hour clock	Press and hold <b>Cancel</b> and <b>Delay</b> pads for 3 to 5 seconds. Press <b>More +</b> or <b>Less -</b> pads to change.	Allows the time on the clock to be toggled from 12-hour or 24-hour display.
M1	Factory default	Press and hold <b>Cancel</b> and <b>Keep Warm</b> pads for 3 to 5 seconds until beep sounds.	Allows the clock to be reset to factory settings.
M1	12-hour off	Control automatically cancels cooking operations and removes relay drives 12 hours after the last pad touch.	See Sabbath mode to disable.
M1	Sabbath mode	Hold <b>Clock</b> pad for 3 to 5 seconds to activate Sabbath mode.  Hold <b>Clock</b> pad for 3 to 5 seconds to disable Sabbath mode.  Initiate desire bake function before entering Sabbath mode.	"SAb" flashes for 5 seconds then remain on until timed-out or cancelled. The status "SAb" is NOT fault code 5A6. All pad inputs are disabled except for <b>CANCEL</b> and <b>CLOCK</b> pads. This mode disables the normal 12 hour shutoff to allow operation of the bake mode for a maximum of 72 hours. The oven light is not disabled.
M1	Child lockout	Press and hold <b>Cancel</b> and <b>Cook &amp; Hold</b> pads for 3 to 5 seconds until beep sounds.  To reactivate the control, press and hold <b>Cancel</b> and <b>Cook &amp; Hold</b> pads for 3 to 5 seconds.	This safety feature is used to prevent children from accidentally programming the oven (the electronic range control is completely disabled).  Child lockout features must be reset after a power failure.
M1	Diagnostic code display	<b>Press and hold More + pad within 30 seconds of powering up the unit.</b>  Cycle through the codes using the <b>More +</b> or <b>Less -</b> pads.	The last 5 diagnostic codes will be stored in the non-volatile memory.  See " <b>Description of Error Codes</b> " for explanation.

# Control Testing Procedures



## WARNING

To avoid risk of electrical shock, personal injury or death; disconnect power to range before servicing, unless testing requires power.

### "Quick Test" Mode for Electronic Range Control

Follow the procedure below to access the quick test mode. Entries must be made within 32 seconds of each other or the control will exit the quick test mode.

1. **Press and hold *Cancel* and *Broil*** pads for 3 to 5 seconds.
2. Once the control has entered the "Quick Test" mode, release both pads.
3. Press each of the following pads indicated in the table below.

**NOTE:** Press one of the following pads once to activate the response.  
Press the pad a second time to deactivate the response.

**NOTE:** This mode must be entered within the first 5 minutes after power up.

**NOTE:** If the temperature sensor is greater than 400° F or if the temperature sensor reaches 400° F while under test, the Quick Test mode will be disabled.

#### Display will indicate the following:

Key	Operation
[Bake]	<b>Bake</b> relay activated, <b>DLB</b> relay activated
[Broil]	<b>Broil</b> relay activated, <b>DLB</b> relay activated
[Keep Warm]	<b>DLB</b> relay activated
[Cook&Hold]	Last Diagnostic Code displayed
[Clean]	<b>MDL</b> relay activated (lock and unlock)
[Delay] (M1)	<b>EEPROM Version Number</b> displayed
[Timer]	<b>Main Code Version Number</b> displayed
[Clock]	<b>All Segments</b> on
[More +]	<b>Even Segments</b> on
[Less -]	<b>Odd Segments</b> on
[Cancel]	End Factory Test Mode

### Description of Error Codes

Error diagnostic codes can only be viewed by entering the Diagnostic Code Display Mode. Each error code consists of four digits and each digit is described in the following table.

Digit	Description
1 <sup>st</sup>	Primary System: 1 – Local to the control circuit board 3 – Sensor or meat probe 4 – Control input 9 – Door lock
2 <sup>nd</sup>	Measurable: d – Diagnostic: measurable parameter c – Control related, replace control
3 <sup>rd</sup>	Secondary System: Sequential numbering
4 <sup>th</sup>	Oven Cavity: 1 – Upper oven (or single cavity oven) 2 – Lower oven c – Control specific

**Diagnostic Code Display Mode must be accessed within 30 seconds of powering up the control.**



# Control Testing Procedures



## WARNING

To avoid risk of electrical shock, personal injury or death; disconnect power to range before servicing, unless testing requires power.

### Diagnostic Code Checking

Code	Description	When Checked	Detection
1c1c	Shorted key	Always	1 minute
1c31	Cancel key circuit problem	Always	1 minute
1c4c	Micro communication failure	Serial communications	5 tries
1c5c	Vcc or ground	Cook or clean active	1 minute
1c6c	EEPROM error	Cook or clean active	5 tries
1c7c	Control not calibrated	Always	5 seconds
1c8c	Cooking program error	Cook or clean active	5 tries
1d11	Runaway temp (650° F), door unlocked	Latch unlocked	5 seconds
1d21	Runaway temp (950° F), door locked	Latch locked	5 seconds
3d11	Sensor open	Cook or clean active	5 seconds
3d21	Sensor shorted	Cook or clean active	5 seconds
4d11	Door position switch not closed when door locked	Clean active	1 minute
4d51	Door switch circuit failure-neither open or closed	Always	1 minute
9d11	Latch will not lock	Latch should be locked	1 minute
9d21	Latch will not unlock	Latch should be unlocked	1 minute
9d31	Unlock state unknown, both locked and unlocked	Always	1 minute
9d41	Unlock state unknown, neither locked or unlocked	Always	1 minute

### Diagnostic Code Handling

Code	Measurable	Displayed	Action Taken By Control
1c1c	Keypress	Nothing	Disables audible for key depression Disables key
1c31	Cancel key improper value	Nothing	Disables all outputs <sup>1</sup>
1c4c	Checksum invalid	Nothing	Disables all outputs <sup>1</sup>
1c5c	Vcc/Gnd at test point	Nothing	No action
1c6c	No response from EEPROM	Nothing	Disables all outputs <sup>1</sup>
1c7c	Calibration value out of range	Nothing	No action
1c8c	CRC invalid	Nothing	Cancels active cook functions
1d11	Sensor resistance > 2293 Ohms	Nothing	Disables all outputs
1d21	Sensor resistance > 2662 Ohms	Nothing	Disables all outputs
3d11	Sensor resistance > Infinite Ohms	BAKE flashes <sup>2</sup>	Disables all cook functions for cavity
3d21	Sensor resistance > 0 Ohms	BAKE flashes <sup>2</sup>	Disables all cook functions for cavity
4d11	Door switch not closed when door locked	Nothing	Disables Clean function <sup>4</sup>
4d51	Door switch not open or closed	LOCK flashes <sup>2</sup>	Disables Clean function <sup>3, 4</sup>
9d11	Lock switch not closed (Clean activated)	LOCK flashes <sup>2</sup>	Ignore soil level selection, disables clean <sup>5</sup>
9d21	Lock switch closed (Clean not activated)	LOCK on steady	Disables cooking functions <sup>5</sup>
9d31	Unlock switch both locked and unlocked	Nothing	No action <sup>5</sup>
9d41	Unlock switch neither locked or unlocked	Nothing	No action <sup>5</sup>
9d51	Lock switch not locked or unlocked	Nothing	Disables Clean function <sup>5</sup>

# Control Testing Procedures



## WARNING

To avoid risk of electrical shock, personal injury or death; disconnect power to range before servicing, unless testing requires power.

### NOTES:

- 1 "Action Taken" applies as long as the condition exists. If the condition is corrected, the control recovers.
- 2 Flash rate: 0.2 seconds on, 0.1 second off. Pressing any key clears the display until the fault clears and is re-triggered.
- 3 "Action Taken" applies until there is a POR (Power On Reset ["hard reset"]).
- 4 If the control believes the door is locked, unlock it when the function cancels and the cavity temperature cools.
- 5 Special conditions for latch faults (9dxx):
  - A known good **unlock** position is defined as when the unlock switch reads closed and lock switch reads open.
  - A known good **lock** position is defined as when the unlock switch reads open and lock switch reads closed.
  - A **faulted switch** means the switch input is reading an invalid state, neither open nor closed.
  - If at POR, the latch is not at a known good unlock position.
  - Affected DLBs (Double Line Breaks) and loads are disabled during detection.
  - If the control is in a known good unlock position and the lock switch becomes faulted:
    - The control will not fault.
    - If a function requiring latch movement is attempted while the lock switch is faulted, the control will sound an error tone and the function will be disabled.

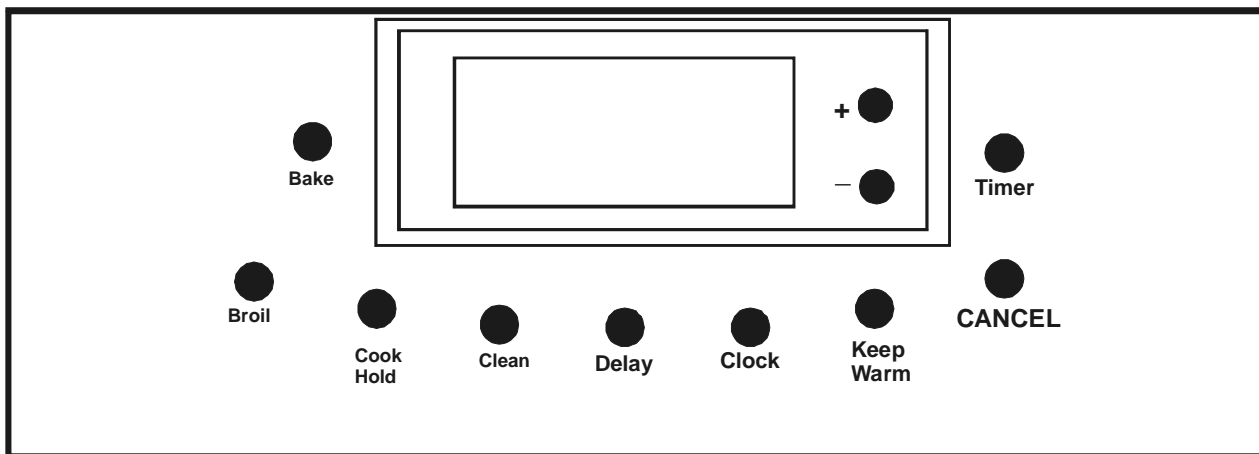

Typical M1 Control

# Disassembly Procedures



To avoid risk of electrical shock, personal injury or death; disconnect power to unit before servicing.

## Removing and Replacing Range

1. Turn off power to the oven at the circuit breaker.
2. Pull the oven forward out of the cabinet opening.
3. Disconnect or unplug the power cord leading from unit to fuse box or junction box depending on unit.
4. Replace the oven using the installation instructions and anti-tip bracket(s).

## Maintop Assembly (Smoothtop Models)

1. Turn power off.
2. Open oven door and remove screws securing maintop to oven chassis, located on the outside edges of the maintop.
3. Raise the front edge of the maintop and pull forward approximately 6 inches.
4. Label and disconnect wire terminal plugs from the maintop assembly.
5. Lift maintop assembly from the oven chassis.
6. Reverse procedures to reinstall maintop assembly.

## Maintop Assembly (Coil Element Models)

1. Turn power off.
2. Open oven door and remove screws securing maintop to oven chassis, located on the outside edges of the maintop.
3. Move the top assembly down, then slightly up and toward the front to unhook the back edge from the backguard.
4. Label and disconnect wire terminal plugs from the maintop assembly.
5. Lift maintop assembly from the oven chassis.
6. Reverse procedures to reinstall maintop assembly.

## Control Panel

1. Remove maintop assembly, see "Maintop Assembly" procedure.
2. Remove screws securing control panel heat shield.
3. Remove screws securing bottom outside edges of the control panel.
4. Pull unit out from the wall far enough to allow the back outside screws to be loosened.
5. Loosen the back outside screws securing control panel to backguard.
6. Grasp front lower outside edges of the control panel and push inward on the outside edges of the backguard to release the control panel front.

**NOTE:** Front edges of the control panel are difficult to release from backguard.

7. Once the control panel bottom edges are free, pull control panel forward and raise the control panel upward to release from screws securing top back edges and allow control panel to tip forward.
8. Remove infinite switch control knobs, infinite switches, indicator lights, rocker switches, and electronic control/clock (as necessary) and transfer the new control panel.
9. Reverse procedures to reinstall control panel.

## Control Board Assembly

1. Remove control panel, see "Control Panel" procedure, steps 1 through 6.
2. Remove screws securing control board bracket to control panel.
3. Label and disconnect terminal plug from control board assembly.
4. Reverse procedures to reinstall control board assembly.

## Infinite Switch

1. Remove control panel, see "Control Panel" procedure for removal.
2. Label and disconnect wire terminals from infinite switch.
3. Remove knob on infinite switch being replaced.
4. Remove screws in front securing infinite switch to control panel.
5. Reverse procedure to reinstall infinite switch.

## Indicator Lights

1. Remove control panel, see "Control Panel" procedure for removal.
2. Label and disconnect wire terminals from indicator light.
3. Slide indicator light while holding the lens from the front to release from control panel.
4. Reverse procedures to reinstall indicator light.

## Rocker Switch

1. Remove control panel, see "Control Panel" procedure for removal.
2. Label and disconnect wire terminals from rocker switch.
3. Squeeze tabs on rocker switch and push outward to release from control panel.
4. Reverse procedures to reinstall indicator light.

# Disassembly Procedures



To avoid risk of electrical shock, personal injury or death; disconnect power to unit before servicing.

## Convenience Outlet/Circuit Breaker (Canadian Models)

1. Remove control panel, see "Control Panel" procedure for removal.
2. Label and disconnect wire terminals from convenience outlet and/or circuit breaker.
3. Remove screws securing outlet and/or circuit breaker to backguard and push outward to release.
4. Reverse procedure to reinstall convenience outlet and/or circuit breaker.

## Oven Sensor

1. Disconnect power before servicing.
2. Open oven door and remove screws securing sensor to oven cavity.

**NOTE:** Gently pull wiring through cavity wall.

3. Disconnect oven sensor at the connector terminal and remove.
4. Reverse procedure to reinstall sensor.

**NOTE:** Verify connection is pushed through the insulation.

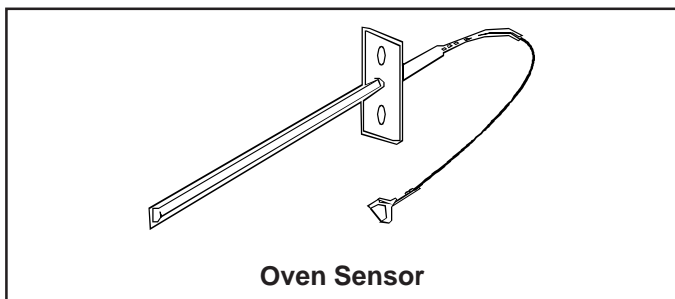

## Bake Element

1. Turn power off.
2. Remove screws securing bake element to rear of oven wall.
3. Pull element forward to allow disconnection of terminals on each element leg.
4. Reverse procedures to reinstall bake element.

## Broil Element

1. Turn power off.
2. Remove screws securing broil element to top and rear of oven cavity.
3. Pull broil element forward to allow disconnection of terminals on each element leg.
4. Reverse procedures to reinstall broil element.

## Ribbon Elements (select models)

1. Remove maintop assembly, see "Maintop Assembly" procedure.
2. Remove screws securing element support bracket to maintop.
3. Label and disconnect wire terminals from element being replaced.
4. Release metal clips securing element to element support bracket.
5. Replace and reverse procedures to reinstall element.

## Coil Element Terminal (select models)

1. Remove maintop assembly, see "Maintop Assembly" procedure.
2. Remove screw securing element support bracket to maintop.
3. Label and disconnect wire terminals from element being replaced.

## Oven Door Latch Assembly (select models)

1. Remove maintop assembly, see "Maintop Assembly" procedure.
2. Remove screws securing latch assembly to the front of the oven cavity outer shell.
3. Label and disconnect wire terminals from latch assembly.
4. Reverse procedures to reinstall door latch assembly.

## Oven Door Removal



To avoid risk of personal injury or property damage, do not lift oven door by the handle.

1. Open oven door slightly and grasp door on both sides.
2. Lift up and off the hinge receivers.
3. Reverse procedures to reinstall oven door.

## Oven Door Hinge

1. Turn off power to unit.
2. Remove oven door, see "Oven Door Removal" procedure.
3. Remove maintop assembly, see "Maintop Assembly" procedure.
4. Remove side panel, see "Side Panel Removal" procedures.

# Disassembly Procedures



To avoid risk of electrical shock, personal injury or death; disconnect power to unit before servicing.

5. Remove storage drawer, see "Storage Drawer Removal" procedure.
6. Remove the top and bottom screws securing oven door hinge to the front frame.
7. Remove oven door hinge from oven chassis.
8. Reverse procedures to reinstall oven door hinge.

## Side Panel Removal

1. Turn power off.
2. Remove oven door, see "Oven Door Removal" procedure.
3. Remove maintop assembly, see "Maintop Assembly" procedure.
4. Remove screws securing lower rear galvanized cover from unit.
5. Remove screws securing top and back of side panel.
6. Pull rear of side panel away from range then slide side panel forward to release from side panel spacers.
7. Reverse procedures to reinstall side panel.

## Backguard Removal

**NOTE:** Requires removal of range from installation position.

1. Remove range from installation position, see "Removing and Replacing Range" procedure.
2. Remove maintop assembly, see "Maintop Assembly" procedure.
3. Remove screws securing upper back panel from unit.
4. Remove screws securing bottom outside edges of the backguard to unit chassis.
5. Reverse procedures to reinstall backguard.

## Storage Drawer Removal

1. Pull drawer straight out to first stop. Lift the front and pull out to second stop.
2. Let front of door rest on floor. Place hands toward back of drawer and lift it out.

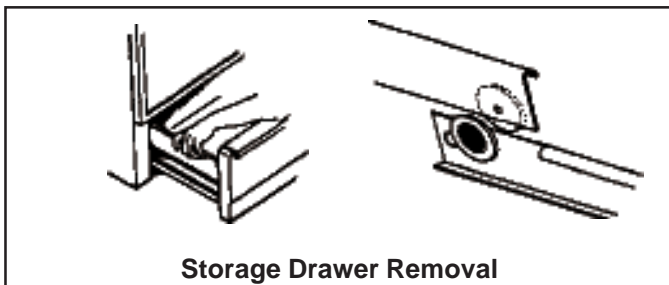

Storage Drawer Removal

3. To replace:
  - a. Place the set of rollers on the drawer behind the set of rollers on the oven. (As shown above.)
  - b. Align the guides and push the drawer back into position.

## Storage Drawer Track Removal

1. Remove the storage drawer by pulling it out to the fully open or stop position, lifting the drawer at the rear to disengage the drawer track rollers from the drawer runners, and sliding the drawer out of the range.
2. The tracks are mounted to a rear support and the frame of the range. Remove the two track mounting screws and remove the track. If the track support is being replaced, remove the mounting screw securing it to the side frame and remove the support.
3. Reverse procedures to replace drawer track.

## Oven Lamp Assembly Removal

### Oven Lamp Socket/Oven Lamp and Lamp Cover

1. Remove power from unit (at the circuit breaker).
2. Open oven door and remove oven racks.
3. Hold lamp cover in place, and slide retaining wire off cover.

**NOTE:** Cover will fall if not held in place when removing retaining wire.

4. Unscrew lamp and remove.
5. Gently pry retaining clips inward towards center of socket.
6. Once retaining clips are released, gently pull socket into oven cavity.
7. Label and disconnect wire terminal connections and remove socket.
8. Reverse procedures to reassemble.

**NOTE:** Reposition fiberglass insulation around oven light socket to eliminate possibility of heat related problems.

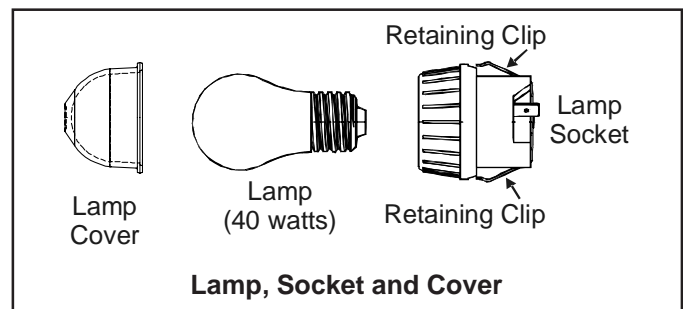

Lamp, Socket and Cover

# Disassembly Procedures



**WARNING**

To avoid risk of electrical shock, personal injury or death; disconnect power to unit before servicing.

## Door Disassembly (Standard and Large Windows)

1. Remove oven door, see "Oven Door Removal" procedure.
2. Place door on a protected surface.
3. Remove screws securing bottom glass support to oven door.
4. Slide inner door glass and trim towards the bottom of oven door and remove (large window models only).
5. Detach right and left door trim pieces.
6. Remove screws securing top door trim to oven door chassis.
7. Remove screws securing door handle brackets to inner door panel.

8. Lift upward on the lower side of the door handle to release side alignment screws and rotate towards the top of the oven door to release and remove.
9. Remove screws securing door handle to door handle brackets.

**NOTE:** Proceed with the following steps for inner door disassembly.

10. Remove screws securing door glass retainer to door baffle and remove.
11. Slide inner door glass downward to release from upper door glass retainers and remove.
12. Remove screws securing door baffle to door lining and remove.
13. Remove insulation from oven door.
14. Lift inner glass and glass frame from oven door.
15. Reverse procedures to reassemble oven door.

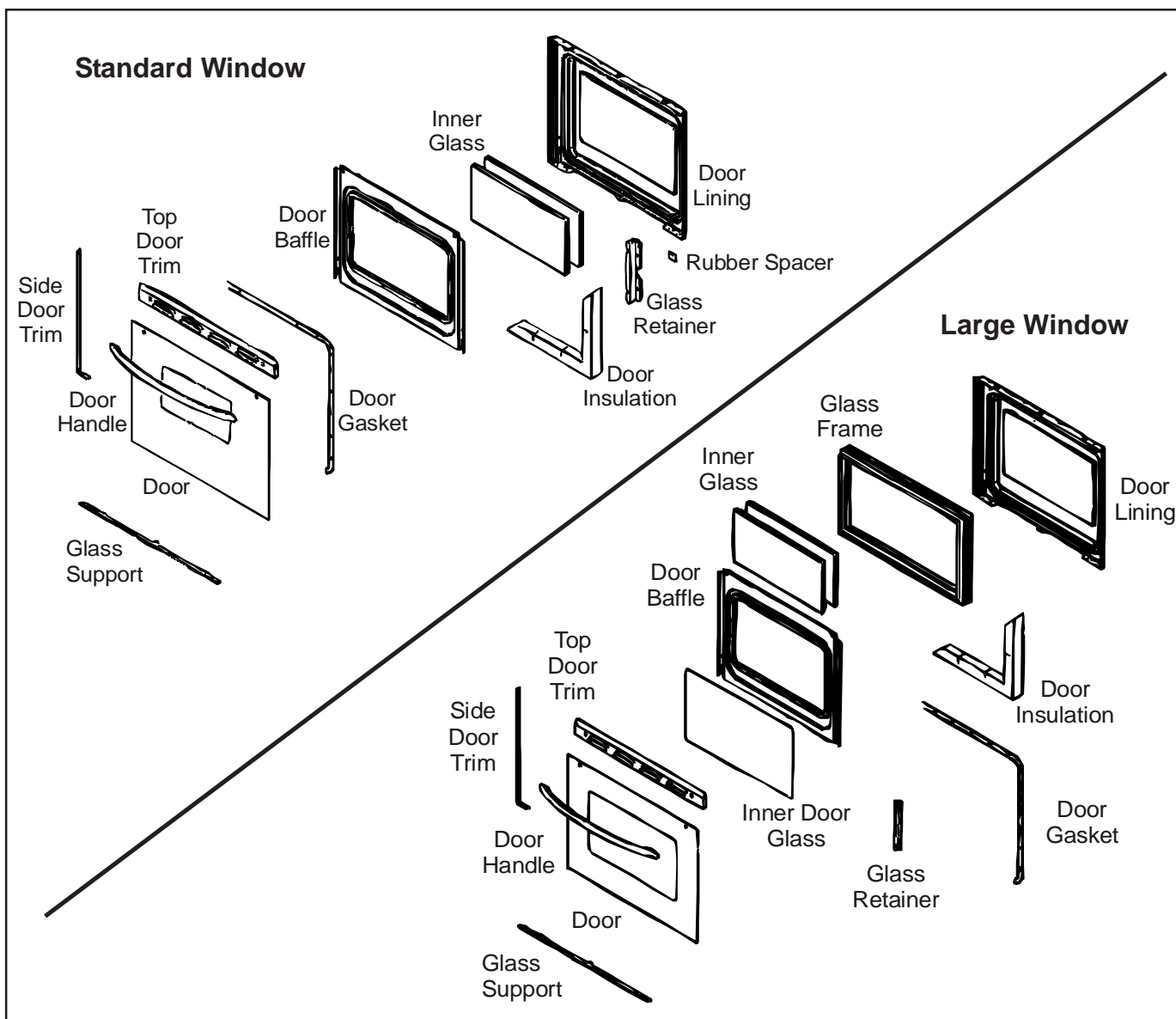

# Disassembly Procedures



## WARNING

To avoid risk of electrical shock, personal injury or death; disconnect power to unit before servicing.

### Door Disassembly (No Window)

1. Remove oven door, see "Oven Door Removal" procedure.
2. Place door on a protected surface.
3. Remove screws securing door handle to door panel.
4. Remove screws securing door panel to door lining and remove door liner.
5. Remove insulation from oven door.
6. Reverse procedures to reassemble oven door.

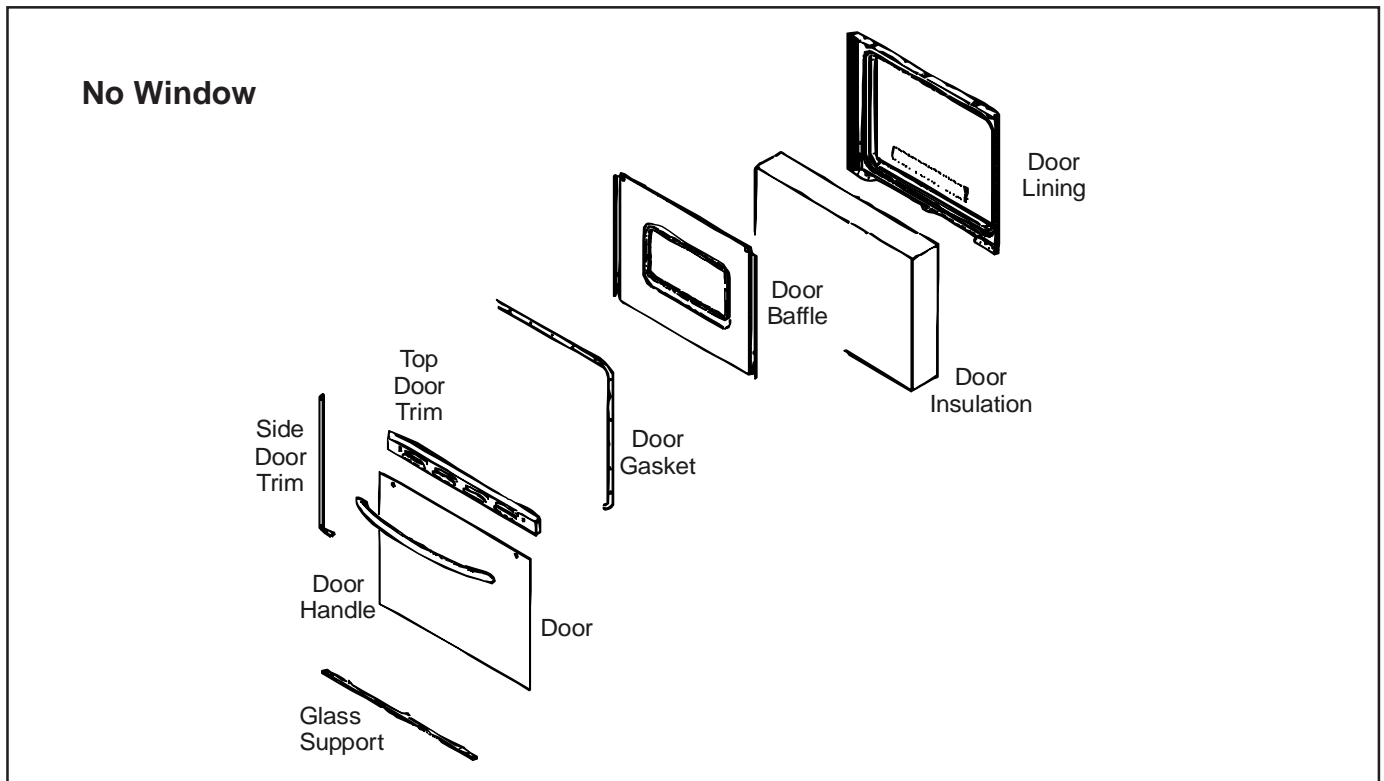

# Disassembly Procedures



## WARNING

To avoid risk of electrical shock, personal injury or death; disconnect power to unit before servicing.

### Storage Drawer Disassembly

1. Remove storage drawer, see "Storage Drawer Removal" procedure.

2. Place door on a protected surface.
3. Remove screws front panel to storage drawer.
4. Reverse procedures to reassemble storage drawer.

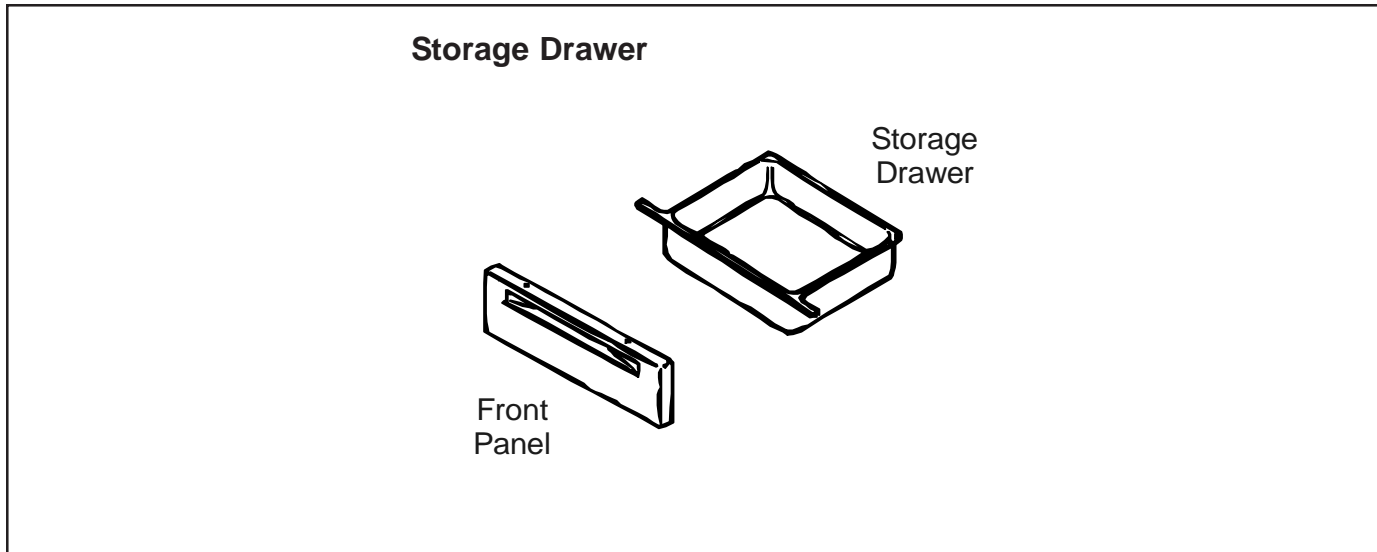



# Appendix A

# Installation Instructions

## INSTALLATION DRAWINGS

**IMPORTANT**  
**PLEASE KEEP FOR THE USE OF THE LOCAL ELECTRICAL INSPECTOR.**

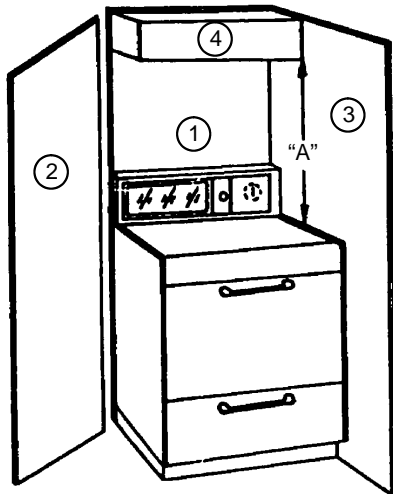

FIGURE 1

NOTE: Figure may not be representative of actual unit.

"A" = 30 inches (76.2 cm) minimum clearance between the top of the cooking surface and the bottom of an unprotected wood or metal cabinet, or "A" = 24 inches (61 cm) minimum when bottom of wood or metal cabinet is protected by not less than 1/4-inch (6.4 mm) thick flame-retardant millboard covered with not less than No. 28 MSG sheet steel, 0.015-inch (0.381 mm) thick stainless steel, 0.024-inch (0.610 mm) thick aluminum, or 0.020-inch (0.508 mm) thick copper.

To eliminate the risk of burns or fire by reaching over heated surface units, cabinet storage space located above the surface units should be avoided. If cabinet storage is to be provided, the risk can be reduced by installing a range hood that projects horizontally a minimum of 5 inches (13 cm) beyond the bottom of the cabinets.

FIGURE 1

- 1, 2, 3 - COMBUSTIBLE BUILDING WALLS.
- 4 - COMBUSTIBLE WALL CABINET.

A free-standing range may be installed adjacent to (0" from) combustible walls 1, 2 & 3.

**NOTE: FOR INSTALLATION IN CANADA, A FREE-STANDING RANGE IS NOT TO BE INSTALLED CLOSER THAN 12MM FROM ANY ADJACENT SURFACE.**

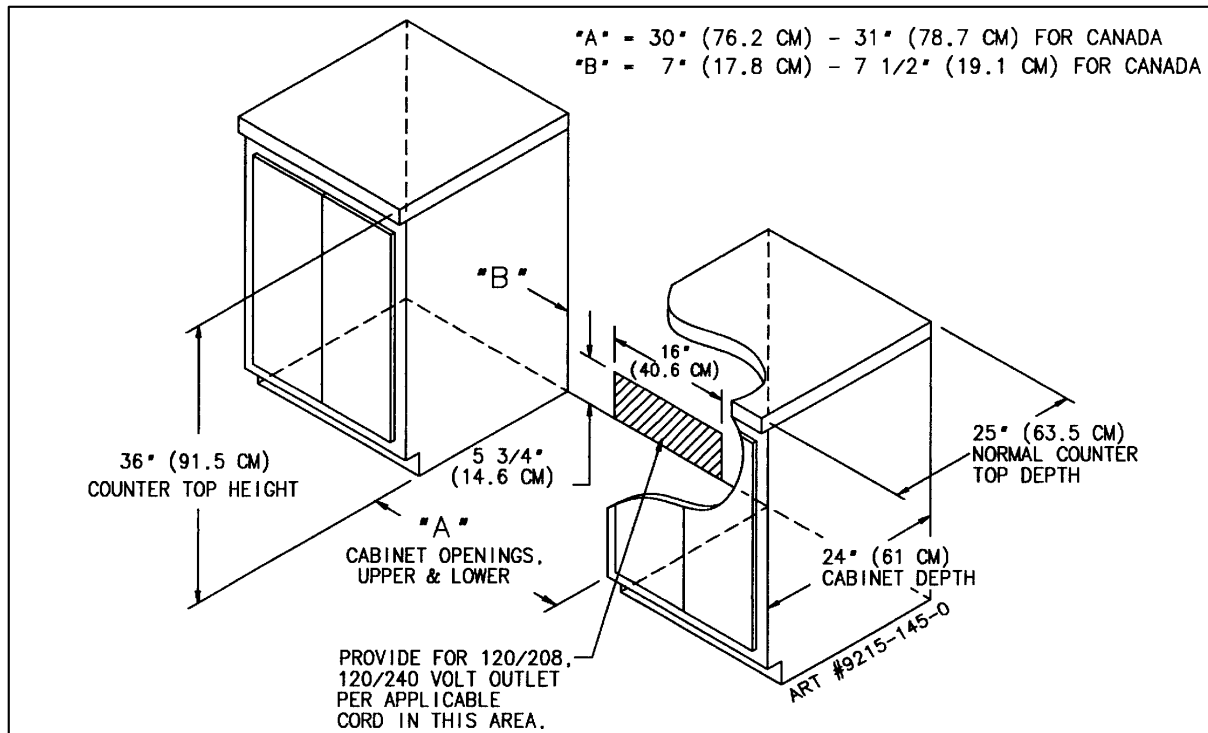

FIGURE 2

# Installation Instructions

## **ANTI-TIP DEVICE INSTALLATION INSTRUCTIONS**

**WARNING:** A risk of range tip-over exists if the appliance is not installed in accordance with the provided installation instructions. The proper use of this device minimizes the risk of TIP-OVER. In using this device the consumer must still observe the safety precautions as stated in the USE and CARE MANUAL and avoid using the oven door and/or lower drawer as a step stool.

Installation instructions are provided for wood and cement in either floor or wall. Any other type of construction may require special installation techniques as deemed necessary to provide adequate fastening of the ANTI-TIP bracket to the floor or wall. The bracket may be installed to engage the left or right rear leveling foot.

### **STEP 1 - Locating The Bracket** (See Figure 3)

- A. Determine where either the right or left "EDGE" of the range will be located and mark the floor or wall.
- B. Place the BRACKET 15/16" (24 mm) from the marked "EDGE" toward center of opening and against the back wall, as shown in figure 3, with orientation hole against wall.
- C. Use the bracket as a template and mark the required holes, as shown in figure 3 for the type of construction you will be using.
- D. Free-standing range may be secured to either floor or wall.

### **STEP 2 - Anti-Tip Bracket Installation Options**

- A. Wood Construction:
  1. Floor: Locate the center of the two holes identified in figure 3 as "HOLES FOR FLOOR". Drill a 1/8" (3 mm) pilot hole in the center of each hole (a nail or awl may be used if a drill is not available). Secure the ANTI-TIP bracket to the floor with the two screws provided. Proceed to Step 3.
  2. Wall: Locate the center of the two holes identified in figure 3 as "HOLES FOR WALL". Drill an angled 1/8" (3 mm) pilot hole in the center of each hole as shown in figure 4. (A nail or awl may be used if a drill is not available). Secure the ANTI-TIP bracket to the wall with the two screws provided as shown in figure 4. Proceed to STEP 3.
- B. Cement or Concrete Construction:
  1. Suitable screws for concrete construction can be obtained at the hardware store. Drill the required size hole for the hardware obtained into the concrete at the center of the holes identified in figure 3 as "HOLES FOR FLOOR". Secure the ANTI-TIP bracket to the floor. Proceed to STEP 3.

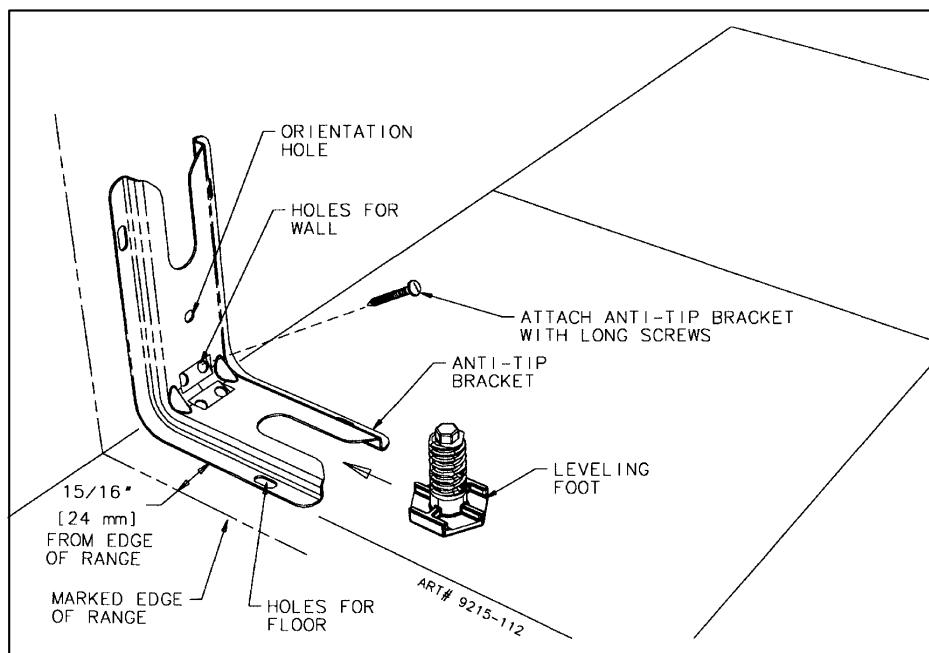

FIGURE 3

# Installation Instructions

## ANTI-TIP DEVICE INSTALLATION INSTRUCTIONS

### STEP 3 - Range Installation

- A. A free-standing range may be installed by one person.
- B. Align the range to its designated location and slide it back into position. Note: A minimum clearance of 1/4" (6 mm) is required between the range and the leveling foot that will engage the ANTI-TIP bracket, see figure 4.
- CAUTION:** Damage to the range may occur if range is moved or lifted by grasping the main top or backguard.
- C. All freestanding ranges with a glass top have a non lift-up top. Coil tops are lift-up.
- D. For SAFETY CONSIDERATIONS as well as optimum performance adjust the range so that it is level. This may be checked by placing a spirit level or a large pan of water on the cooktop or the oven rack. If an adjustment is required pull the range forward, tip the range and rotate the leveling feet as required.
- E. To check the range for proper installation of the anti-tip bracket: Use a flashlight and look underneath the bottom of the range to see that one of the rear leveling feet is engaged in the bracket slot.
- F. Proceed with the remainder of the installation instructions provided with the range.

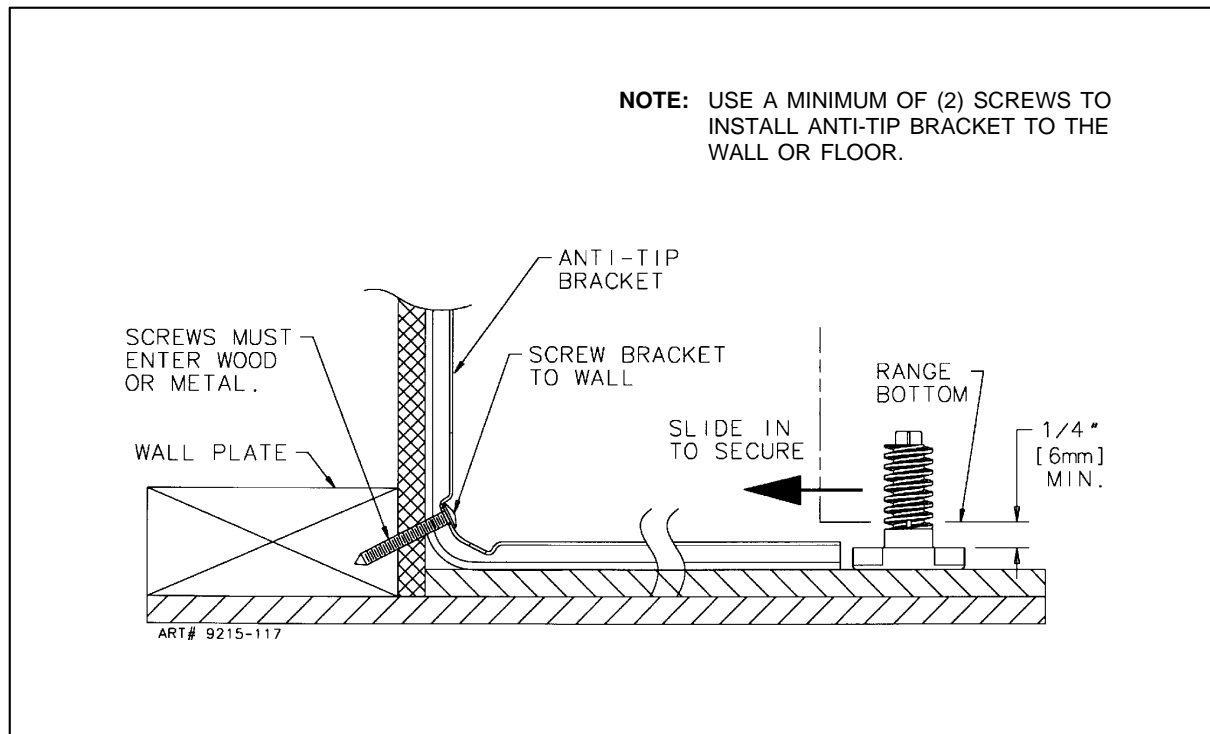

FIGURE 4

# Installation Instructions

## **CONNECTING THE RANGE**

### **ELECTRIC SUPPLY**

The range must be installed in accordance with Local and National Electric Code (NEC) ANSI/NFPA No. 70-latest edition. See rating plate for total connected KW rating.

### **ELECTRIC SUPPLY (Canada)**

The range must be installed in accordance with Local and Canadian Electric Code CSA STD.C22.1 latest edition. See rating plate for total connected KW rating.

### **OUTSIDE WIRING**

Your local utility company will tell you whether the present electric service to your home is adequate. It may be necessary to increase the size of the wiring to the house and service switch to take care of the electrical load demanded by the range. The kilowatt rating for the range is specified on the rating plate located on front of range.

### **HOUSE WIRING**

Most local Building Regulations and Codes require that all electrical wiring be done by licensed electricians. All wiring should conform to Local and National Electrical Codes. This range requires a single phase three wire 120/240 or a 120/208 volt, 60 Hz, AC circuit. Wiring codes require a separate circuit be run from the main entrance panel to the range and that it be equipped with separate disconnect switch and fuses, either in the main entrance panel or in a separate switch and fuse box. In some communities, a solid or flexible continuous armored conduit must be used from main entrance panel to the terminal box on the rear of the range. Others will permit the termination of the range circuit at a polarized three or four wire plug-in outlet placed at a convenient point near the back of the range. The range is then connected to this outlet through an approved range connector (pigtail) fastened securely to the terminal block with proper strain relief at the range and a three or four pronged plug at the opposite end.

### **RANGE CONNECTIONS**

Some models are shipped direct from the factory with service cords (pigtails) attached. There are no range connections necessary on these models. Just plug into the range outlet. On models not provided with a service cord, connection to the power supply is necessary. **REMEMBER** - only a 4-conductor cord is to be used on new branch-circuit installations (1996 NEC), mobile homes, recreational vehicles, or in an area where local codes prohibit grounding through the neutral conductor.

Hence, 4-wire service **MUST** be provided for such installations. 3-wire service may be used when permitted by local code. **USE COPPER OR ALUMINUM CONDUCTORS.** Main terminal block is recognized for Copper or Aluminum conductors. Make connections as explained below and with reference to the appropriate illustration (see figures 6 and 7). After installation, insure tightness of all electrical connections and replace all covers.

Remove terminal block access cover from range back. (See figure 5).

### **RANGE CONNECTIONS (Canada)**

This model was shipped direct from the factory with service cord (pigtail) attached. There are no range connections necessary. Just plug into the range outlet. See figure 2 on page 2 for outlet location.

**NOTE:** Cord replacement - **ONLY** a power supply cord rated at 240 volts minimum, 40 amperes or 50 amperes power supply cord that is marked for use with nominal 1 3/8" (34.93 mm) diameter connection opening, with closed loop terminals and marked for use with ranges shall be used.

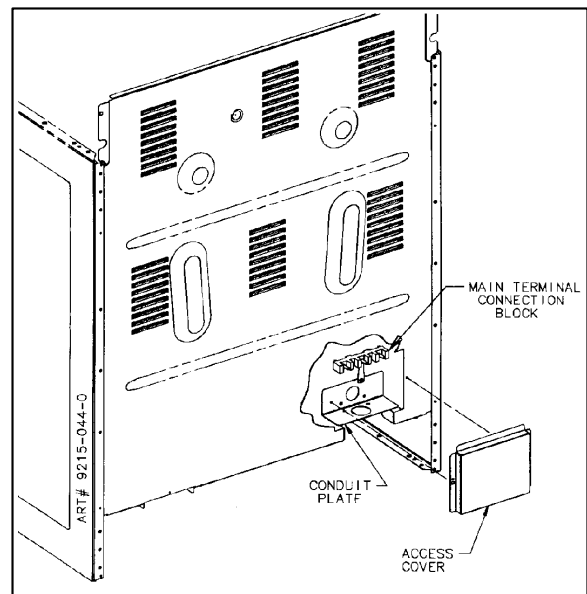
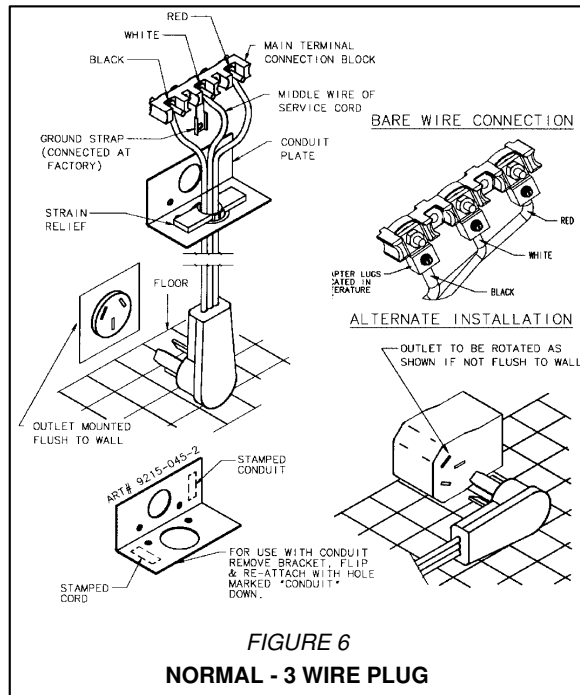

FIGURE 5

# Installation Instructions

**FIGURE 6**  
**3-Wire Service Cord or Conduit Installation**

1. Insure that the copper ground strap **IS CONNECTED** between the middle post of the main terminal connection block and the range chassis.
2. If bare copper or aluminum wiring is used, attach adapter lugs as shown in figure 6. (See Bare Wire Connection). Torque specifications are shown below.
3. The middle wire of the service cord or ground lead of 3-wire conduit **MUST** connect to the neutral (middle) post of the main terminal block. The other two wires of the service cord or conduit connect to the outside posts of the main terminal connection block. Polarity is unimportant. (If using bare wire, attach wire to appropriate lug as shown. Torque specifications are shown below).
4. An appropriate strain relief for service cord or conduit **MUST** be attached to the conduit plate.



**FIGURE 6**  
**NORMAL - 3 WIRE PLUG**

**Conversion From 3-Wire To 4-Wire Service (Free-Standing Models With 3-Wire Service Cord Attached).**

Disconnect range from power. Remove the access cover on back of range and remove the 3-wire service cord from the main terminal block. Follow instructions as outlined in figure 9 to connect the 4-wire service cord.

**NOTE:** Cord replacement - **ONLY** a power supply cord rated at 240 volts minimum, 40 amperes or 50 amperes power supply cord that is marked for use with nominal 1 3/8" (34.93 mm) diameter connection opening, with closed loop terminals and marked for use with ranges shall be used.

**FIGURE 7**  
**4-Wire Service Cord or Conduit Installation (Mobile Homes Or As Required By Codes)**

1. The copper ground strap connected between the neutral (middle) post of the main terminal block and the chassis **MUST** be cut off as shown in figure 7. Save the green ground screw to attach the ground from the 4 wire cord. Only a 4 wire cord or conduit should be used.
2. If bare copper or aluminum wiring is used, attach adapter lugs as shown in figure 7. (See Bare Wire Connection). Torque specifications are shown below.
3. The ground wire from the service cord or conduit must connect to the range chassis using the green ground screw.
4. The white wire of the service cord must connect to the neutral (middle) post of the main terminal block. The other two wires of the service cord connect to the red and black posts of the main terminal block, respectively. (If using bare wire, attach wire to appropriate lug as shown. Torque specifications are shown below).
5. An appropriate strain relief for service cord or conduit **MUST** be attached to the conduit plate.

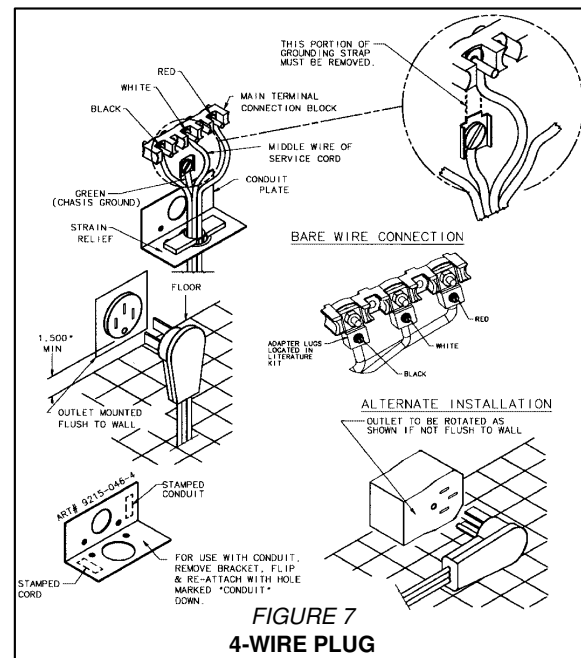

**FIGURE 7**  
**4-WIRE PLUG**

**Bare Wire Torque Specifications**  
**Lug attached to Terminal Block - 20 in-lb**

Wire AWG	Torque
10 - 14	20 in-lb
8	25 in-lb
4 - 6	35 in-lb

# Appendix B

**The Use and Care information provided in this service manual is representative of a limited number of models. Reference the customer's Use and Care literature included with the product, order a copy (if needed), or consult Maytag's website for the specific model.**

**[www.maytag.com](http://www.maytag.com)**

# Use and Care Guide

Electric Range -  
Smoothtop



# Range

## Table of Contents

	<b>Safety</b> ..... 1-3		<b>Care &amp; Cleaning</b> ..... 17-20
	<b>Surface Cooking</b> ..... 4-7		Self-Clean Oven Cleaning Procedures
	Surface Controls Smoothtop Surface		<b>Maintenance</b> ..... 21-22
	<b>Oven Cooking</b> ..... 8-16		Oven Window Oven Light
	Baking Cook & Hold Delay Bake Keep Warm Broiling Oven Racks		<b>Troubleshooting</b> ..... 22-23
			<b>Warranty &amp; Service</b> ..... 25

©2005 Maytag Appliances Sales Co.

Litho U.S.A .



# Use and Care Guide

**Installer:** Please leave this guide with this appliance.

**Consumer:** Please read and keep this guide for future reference. Keep sales receipt and/or canceled check as proof of purchase.

Model Number \_\_\_\_\_

Serial Number \_\_\_\_\_

Date of Purchase \_\_\_\_\_

If you have questions, call:

Maytag Customer Assistance

1-800-688-9900 USA

1-800-688-2002 Canada

1-800-688-2080 ( U.S. TTY for hearing or speech impaired)

(Mon.-Fri., 8 am-8 pm Eastern Time)

Internet: <http://www.maytag.com>

In our continuing effort to improve the quality and performance of our cooking products, it may be necessary to make changes to the appliance without revising this guide.

*For service information, see page 25.*

replace any part of your appliance unless it is specifically recommended in this guide. All other servicing should be referred to a qualified servicer.

Always disconnect power to appliance before servicing.

## **WARNING**

- **ALL RANGES CAN TIP AND CAUSE INJURIES TO PERSONS**
- **INSTALL ANTI-TIP DEVICE PACKED WITH RANGE**
- **FOLLOW ALL INSTALLATION INSTRUCTIONS**



**WARNING: To reduce risk of tipping of the appliance from abnormal usage or by excessive loading of the oven door, the appliance must be secured by a properly installed anti-tip device.**

## **Important Safety Instructions**

Warning and Important Safety Instructions appearing in this guide are not meant to cover all possible conditions and situations that may occur. Common sense, caution, and care must be exercised when installing, maintaining, or operating the appliance.

Always contact the manufacturer about problems or conditions you do not understand.

### Recognize Safety Symbols, Words, Labels

#### **WARNING**

**WARNING** – Hazards or unsafe practices which COULD result in severe personal injury or death.

#### **CAUTION**

**CAUTION** – Hazards or unsafe practices which COULD result in minor personal injury.

**Read and follow all instructions before using this appliance** to prevent the potential risk of fire, electric shock, personal injury or damage to the appliance as a result of improper usage of the appliance. Use appliance only for its intended purpose as described in this guide.

**To ensure proper and safe operation:** Appliance must be properly installed and grounded by a qualified technician. Do not attempt to adjust, repair, service, or

To check if device is properly installed, look underneath range with a flashlight to make sure one of the rear leveling legs is properly engaged in the bracket slot. The anti-tip device secures the rear leveling leg to the floor when properly engaged. You should check this **anytime** the range has been moved.

## **To Prevent Fire or Smoke Damage**

Be sure all packing materials are removed from the appliance before operating it.

Keep area around appliance clear and free from combustible materials. Flammable materials should not be stored in an oven.

Many plastics are vulnerable to heat. Keep plastics away from parts of the appliance that may become warm or hot.

To prevent grease fires, do not let cooking grease or other flammable materials accumulate in or near the appliance.

## **In Case of Fire**

Use dry chemical or foam-type extinguisher or baking soda to smother fire or flame. Never use water on a grease fire.

1. Turn off appliance to avoid spreading the flame.
2. **NEVER** pick up or move a flaming pan.
3. Smother oven fire or flame by closing the oven door.



## Important Safety Instructions

### Child Safety



#### CAUTION

**NEVER** store items of interest to children in cabinets above an appliance. Children climbing on the appliance or on the appliance door to reach items could be seriously injured.

**NEVER** leave children alone or unsupervised near the appliance when it is in use or is still hot. Children should never be allowed to sit or stand on any part of the appliance as they could be injured or burned.

Children must be taught that the appliance and utensils in it can be hot. Let hot utensils cool in a safe place, out of reach of small children. Children should be taught that an appliance is not a toy. Children should not be allowed to play with controls or other parts of the appliance.

### About Your Appliance



#### CAUTION

**NEVER** use an appliance as a step to reach cabinets above. Misuse of appliance door, such as stepping, leaning or sitting on the door, may result in possible tipping of the appliance, breakage of door, and serious injuries.

To prevent potential hazard to the user and damage to the appliance, do not use appliance as a space heater to heat or warm a room. Also, do not use the oven as a storage area for food or cooking utensils.

Do not obstruct the flow of air by blocking the oven vent.

**DO NOT TOUCH HEATING ELEMENTS OR INTERIOR SURFACES OF OVEN.** Heating elements may be hot even though they are dark in color. Interior surfaces of any oven become hot enough to cause burns. During and after use, do not touch, or let clothing or other flammable materials contact heating elements or interior surfaces of oven until they have had sufficient time to cool. Other surfaces of the appliance may become hot enough to cause burns – among these surfaces are: oven vent opening, surface near this opening, oven door, and window of oven door.

Do not touch a hot oven light bulb with a damp cloth as the bulb could break. Should the bulb break, disconnect power to the appliance before removing bulb to avoid electrical shock.

**NEVER** use aluminum foil to cover an oven rack or oven bottom. Misuse could result in risk of electric shock, fire, or damage to the appliance. Use foil only as directed in this guide.

### Cooking Safety

Never heat an unopened food container in the oven. Pressure build-up may cause container to burst resulting in serious personal injury or damage to the appliance.

Use dry, sturdy potholders. Damp potholders may cause burns from steam. Dish towels or other substitutes should never be used as potholders because they can trail across hot elements and ignite or get caught on appliance parts.

Wear proper apparel. Loose fitting or long hanging-sleeved apparel should not be worn while cooking. Clothing may ignite and cause burns if garment comes in contact with heating elements.

Always place oven racks in the desired positions while oven is cool. Slide oven rack out to add or remove food, using dry, sturdy potholders. Always avoid reaching into the oven to add or remove food. If a rack must be moved while hot, use a dry potholder. Do not let potholder contact hot element in oven.

Use racks only in the oven in which they were shipped/purchased.

Use care when opening the oven door. Let hot air or steam escape before removing or replacing food.

**PREPARED FOOD WARNING:** Follow food manufacturer's instructions. If a plastic frozen food container and/or its cover distorts, warps, or is otherwise damaged during cooking, immediately discard the food and its container. The food could be contaminated.

Do not allow aluminum foil or meat probe to contact heating element.

Always turn off all controls when cooking is completed.

### Utensil Safety

Follow the manufacturer's directions when using oven cooking bags.

This appliance has been tested for safe performance using conventional cookware. Do not use any devices or accessories that are not specifically recommended in this manual. Do not use stove top grills or add-on oven convection systems. The use of devices or accessories that are not expressly recommended in this manual can create serious safety hazards, result in performance problems, and reduce the life of the components of this appliance.

Be sure utensil is large enough to properly contain food and avoid boilovers. Pan size is particularly important in deep fat frying. Be sure pan will accommodate the volume of food that is to be added as well as the bubble action of fat.

# Use and Care Guide



## Important Safety Instructions

Never let a pan boil dry as this could damage the utensil and the appliance.

If pan is smaller than element, a portion of the element will be exposed to direct contact and could ignite clothing or potholder.

Only certain types of glass, glass/ceramic, ceramic, earthenware, or other glazed utensils are suitable for cooktop or oven service without breaking due to the sudden change in temperature. Follow utensil manufacturer's instructions when using glass.

Turn pan handle toward center of cooktop, not out into the room or over another surface element. This reduces the risk of burns, ignition of flammable materials, or spillage if pan is accidentally bumped or reached by small children.

### Cooktop

**NEVER** leave surface units unattended especially when using high heat. An unattended boilover could cause smoking and a greasy spillover can cause a fire.

This appliance is equipped with different size surface elements. Select pans with flat bottoms large enough to cover element. Fitting pan size to element will improve cooking efficiency.

**GLASS-CERAMIC SURFACE: NEVER** cook on broken cooktop. If cooktop should break, cleaning solutions and spillovers may penetrate the broken cooktop and create a risk of electric shock. Contact a qualified technician immediately.

### Deep Fat Fryers

Use extreme caution when moving the grease pan or disposing of hot grease. Allow grease to cool before attempting to move pan.

### Ventilating Hoods

Clean range hood and filters frequently to prevent grease or other flammable materials from accumulating on hood or filter and to avoid grease fires.

When flaming foods under the hood, turn the fan on.

### Cleaning Safety

Clean cooktop with caution. Turn off all controls and wait for appliance parts to cool before touching or cleaning. Clean with caution. Use care to avoid steam burns if a wet sponge

or cloth is used to wipe spills on a hot surface. Some cleaners can produce noxious fumes if applied to a hot surface.

Clean only parts listed in this guide.

### Self-Clean Oven

#### CAUTION

Do not leave racks, broiling pan, food or cooking utensils, etc. in the oven during the self-clean cycle.

Do not clean door gasket. The door gasket is essential for a good seal. Care should be taken not to rub, damage, or move the gasket.

Do not use oven cleaners or oven liners of any kind in or around any part of the self-clean oven.

Before self-cleaning the oven, remove broiler pan, oven racks and other utensils, and wipe off excessive spillovers to prevent excessive smoke or flare ups.

It is normal for the cooktop of the range to become hot during a self-clean cycle. Therefore, touching the cooktop during a clean cycle should be avoided.

### Important Safety Notice and Warning

The California Safe Drinking Water and Toxic Enforcement Act of 1986 (Proposition 65) requires the Governor of California to publish a list of substances known to the State of California to cause cancer or reproductive harm, and requires businesses to warn customers of potential exposures to such substances.

Users of this appliance are hereby warned that when the oven is engaged in the self-clean cycle, there may be some low-level exposure to some of the listed substances, including carbon monoxide. Exposure to these substances can be minimized by properly venting the oven to the outdoors by opening the windows and/or door in the room where the appliance is located during the self-clean cycle.

**IMPORTANT NOTICE REGARDING PET BIRDS:** Never keep pet birds in the kitchen or in rooms where the fumes from the kitchen could reach. Birds have a very sensitive respiratory system. Fumes released during an oven self-cleaning cycle may be harmful or fatal to birds. Fumes released due to overheated cooking oil, fat, margarine and overheated non-stick cookware may be equally harmful.

**Save These Instructions for Future Reference**

# Use and Care Guide

## Surface Cooking

### Surface Controls

Use to turn on the surface elements. An infinite choice of heat settings is available from **Low** to **High**. The knobs can be set on or between any of the settings.

### Setting the Controls

1. Place pan on surface element.
2. Push in and turn the knob in either direction to the desired heat setting.
  - The control panel is marked to identify which element the knob controls. For example, the graphic at right indicates left front element.
3. There is an element indicator light on the control panel. When any surface control knob is turned on, the light will turn on. The light will turn off when all the surface elements are turned off.
4. After cooking, turn knob to **OFF**. Remove pan.



### Suggested Heat Settings

The size and type of cookware, type and amount of food being heated, and wattage of individual elements will determine where to set the knob for cooking operations. Some elements have a predetermined simmer and melt setting that will require only minor adjustment up or down depending on the food being prepared. The other elements have settings printed around the knobs that are also unique to those elements. Adjust the heat settings to the numbers that give the desired cooking results. For information on cookware and other factors affecting heat settings, refer to Cookware Recommendations on page 7 or the "Cooking Made Simple" booklet. The following descriptions will aid in choosing the settings that will give optimum results.

**Hold or Warm:** Food maintains a temperature above 140°F without continuing to cook. Food is initially hot and then heat is reduced. Never use a hold or warm setting to reheat cold food.

**Simmer:** Food forms bubbles that barely break the surface. Foods are between 185°F and 200°F. A simmer setting can also be used to steam or poach foods or continue cooking covered foods.

**Slow Boil:** Food forms bubbles at a moderate pace. A slow boil setting can also be used for most frying and for maintaining the cooking of large amounts of liquids.

**Boil:** Liquid forms bubbles at a rapid pace. A fast boil setting can also be used to brown meat, stir fry, sauté, and heat oil for frying before turning to a lower setting. The highest 3 or 4 settings on the knob are used for these cooking operations. The highest setting is always used to bring water to a boil. Some elements offer an even higher speed for boiling liquids.

### Dual Element (select models)

The cooking surface has a dual element located at the left front of the smoothtop. This allows you to change the size of the element.

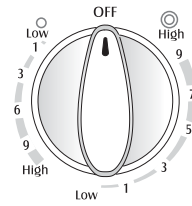

The small element is operated on the left side of the knob control. To operate the entire element, use the right side of the knob control. The control for both element sizes can be set anywhere between **Low** and **High**.

### Flex-Choice™ Element (select models)

The Flex-Choice™ element is a fully functioning element that provides an ultra low **Melt** heat setting for melting chocolate and butter. It is located in the left rear position

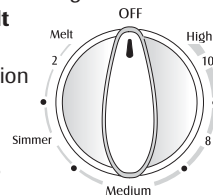

The **Melt** setting is located between **2** and **OFF**. Heat settings outside of this area function as a normal element, with **2** (Low) to **High** settings.

**Note:** When using the normal settings for preparing foods, it may take a few minutes for the cooking area to cool to the Melt heat setting.

### Warming Center

Use the Warming Center to keep hot cooked foods warm, such as vegetables and gravies.

Warming Center

#### Setting the Control:

1. Push in and turn the knob. Warming temperatures are approximate and are indicated on the control as **Low**, **2-10** and **High**. However, the control can be set to any position between **Low** and **High**.
2. When done, turn the control to **OFF** and remove food. The Hot Surface indicator light will go off when the Warming Center surface has cooled.

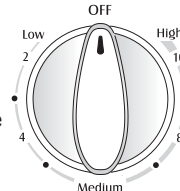

#### Notes:

- **Never** warm food for longer than one hour (eggs for 30 minutes), as food quality may deteriorate.
- Do not heat cold food on the Warming Center.
- Heat settings will vary depending on type and amount of food. Always hold food at proper food temperatures. USDA recommends food temperatures between 140°-170° F.

# Use and Care Guide



## Surface Cooking

### Warming Center Suggested Settings

Setting	Type of food
<b>Low - 2</b>	Breads/Pastries Casseroles Gravies Eggs
<b>2 - Medium</b>	Sauces Stews Meats Soups (Cream) Vegetables
<b>Medium - High</b>	Fried Foods Soups (Liquid) Hot Beverages

### Warming Center Notes:

- Use only cookware and dishes recommended as safe for oven and cooktop use.
- Always use oven mitts when removing food from the Warming Center as utensils will be hot.
- All foods should be covered with a lid or aluminum foil to maintain food quality.
- When warming pastries and breads the cover should have an opening to allow moisture to escape.
- Do not use plastic wrap to cover foods. Plastic may melt on to the surface and be very difficult to clean.
- Be very careful not to allow aluminum foil to touch the cooktop. If foil melts, do not use the cooktop. Call an authorized Maytag servicer.

## Smoothtop Surface

### Smoothtop Surface Notes:

- **Cooktop may emit light smoke and odor** the first few times the cooktop is used. This is normal.
- **Smoothtop cooktops retain heat for a period of time after the element is turned off.** Turn the elements off a few minutes before food is completely cooked and use the retained heat to complete cooking. When the hot surface light turns off, the cooking area will be cool enough to touch. Because of the way they retain heat, the smoothtop elements will not respond to changes in settings as quickly as coil elements.
- In the event of a potential boilover, remove the pan from the cooking surface.
- **Never attempt to lift the cooktop.**
- The smoothtop surface may appear discolored when it is hot. This is normal and will disappear when the surface cools.

### Cooking Areas

The cooking areas on your range are identified by permanent circles on the smoothtop surface. For most efficient cooking, fit the pan size to the element size.

**Pans should not extend more than 1-inch beyond the cooking area.**

cont.

## CAUTION

### BEFORE COOKING

- Always place a pan on the surface unit before you turn it on. To prevent damage to range, never operate surface unit without a pan in place.
- **NEVER** use the cooktop as a storage area for food or cookware.

### DURING COOKING

- Be sure you know which knob controls which surface unit. Make sure you turned on the correct surface unit.
- Begin cooking on a higher heat setting then reduce to a lower setting to complete the operation. Never use a high heat setting for extended cooking.
- **NEVER** allow a pan to boil dry. This could damage the pan and the appliance.
- **NEVER** touch cooktop until it has cooled. Expect some parts of the cooktop, especially around the surface units, to become warm or hot during cooking. Use potholders to protect hands.

### AFTER COOKING

- Make sure surface unit is turned off.
- Clean up messy spills as soon as possible.

### OTHER TIPS

- If cabinet storage is provided directly above cooking surface, limit it to items that are infrequently used and can be safely stored in an area subjected to heat. Temperatures may be unsafe for items such as volatile liquids, cleaners or aerosol sprays.
- **NEVER** leave any items, especially plastic items, on the cooktop. The hot air from the vent may ignite flammable items, melt or soften plastics, or increase pressure in closed containers causing them to burst.
- **NEVER** allow aluminum foil, meat probes or any other metal object, other than a pan on a surface element, to contact heating elements.
- **NEVER** store heavy items above the cooktop that could fall and damage it.

# Use and Care Guide



## Surface Cooking

When a control is turned on, a glow can be seen through the smoothtop surface. **The element will cycle on and off to maintain the preset heat setting, even on Hi.**

For more information on cookware, refer to Cookware Recommendations on page 7 and “Cooking Made Simple” booklet included with your range.

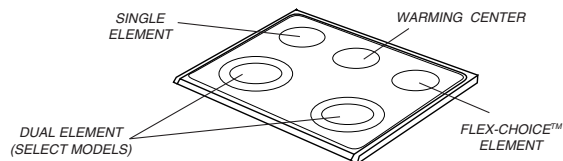

### Hot Surface Light

The Hot Surface indicator light is located on the control panel. The light will be illuminated when any cooking area is hot. It will remain on, even after the control is turned off, until the area has cooled.



Hot Surface

## Tips to Protect the Smoothtop Surface

### Cleaning (see page 19 for more information)

- Before first use, clean the cooktop.
- Clean your cooktop daily or after each use. This will keep your cooktop looking good and can prevent damage.
- If a spillover occurs while cooking, immediately clean the spill from the cooking area while it is hot to prevent a tough cleaning chore later. Using extreme care, wipe spill with a clean dry towel.
- Do not allow spills to remain on the cooking area or the cooktop trim for a long period of time.
- **Never** use abrasive cleansing powders or scouring pads which will scratch the cooktop.
- **Never** use chlorine bleach, ammonia or other cleansers not specifically recommended for use on glass-ceramic.

### To Prevent Marks and Scratches

- Do not use glass pans. They may scratch the surface.
- **Never** place a trivet or wok ring between the surface and pan. These items can mark or etch the top.
- Do not slide aluminum pans across a hot surface. The pans may leave marks which need to be removed promptly. (See Cleaning, page 19.)
- Make sure the surface and the pan bottom are clean before turning on to prevent scratches.
- To prevent scratching or damage to the glass-ceramic top, do not leave sugar, salt or fats on the cooking area. Wipe the cooktop surface with a clean cloth or paper towel before using.
- **Never** slide heavy metal pans across the surface since these may scratch.

### To Prevent Stains

- **Never** use a soiled dish cloth or sponge to clean the cooktop surface. A film will remain which may cause stains on the cooking surface after the area is heated.
- Continuously cooking on a soiled surface may/will result in a permanent stain.

### To Prevent Other Damage

- Do not allow plastic, sugar or foods with high sugar content to melt onto the hot cooktop. Should this happen, clean immediately. (See Cleaning, page 19.)
- **Never** let a pan boil dry as this will damage the surface and pan.
- **Never** use cooktop as a work surface or cutting board.
- **Never** cook food directly on the surface.
- Do not use a small pan on a large element. Not only does this waste energy, but it can also result in spills burning onto the cooking area which requires extra cleaning.
- Do not use non-flat specialty items that are oversized or uneven such as round bottom woks, rippled bottom and/or oversized canners and griddles.
- Do not use foil or foil-type containers. Foil may melt onto the glass. If metal melts on the cooktop, do not use. Call an authorized Maytag Servicer.

# Use and Care Guide

## **Surface Cooking**

### Cookware Recommendations

Using the right cookware can prevent many problems, such as food taking longer to cook or achieving inconsistent results. Proper pans will reduce cooking times, use less energy, and cook food more evenly.

#### Flat Pan Tests

See if your pans are flat.

##### The Ruler Test:

1. Place a ruler across the bottom of the pan.
2. Hold it up to the light.
3. Little or no light should be visible under the ruler.

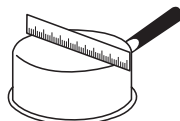

##### The Bubble Test:

1. Put 1 inch of water in the pan. Place on cooktop and turn control to **High**.
2. Watch the formation of the bubbles as the water heats. Uniform bubbles mean good performance, and uneven bubbles indicate hot spots and uneven cooking.

See "Cooking Made Simple" booklet for more information.

Select	Avoid
Flat, smooth-bottom pans.	Pans with grooved or warped bottoms. Pans with uneven bottoms do not cook efficiently and sometimes may not boil liquid.
Heavy-gauge pans.	Very thin-gauge metal or glass pans.
Pans that are the same size as the element.	Pans smaller or larger than the element by 1 inch.
Secure handles.	Cookware with loose or broken handles. Heavy handles that tilt the pan.
Tight-fitting lids.	Loose-fitting lids.
Flat bottom woks.	Woks with a ring-stand bottom.

### Canning and Oversize Cookware

**All canners and large pots must have flat bottoms and must be made from heavy-gauge materials.** This is critical on smoothtop surfaces. The base must not be more than 1 inch larger than the element.

When canners and pots do not meet these standards, cooking times may be longer, and cooktops may be damaged.

Some canners are designed with smaller bases for use on smoothtop surfaces.

**When canning, use the High heat setting only until the water comes to a boil** or pressure is reached in the canner. Reduce to the lowest heat setting that maintains the boil or pressure. If the heat is not turned down, the cooktop may be damaged.

See "Cooking Made Simple" booklet for more information.

# Use and Care Guide



## Oven Cooking

### Control Panel

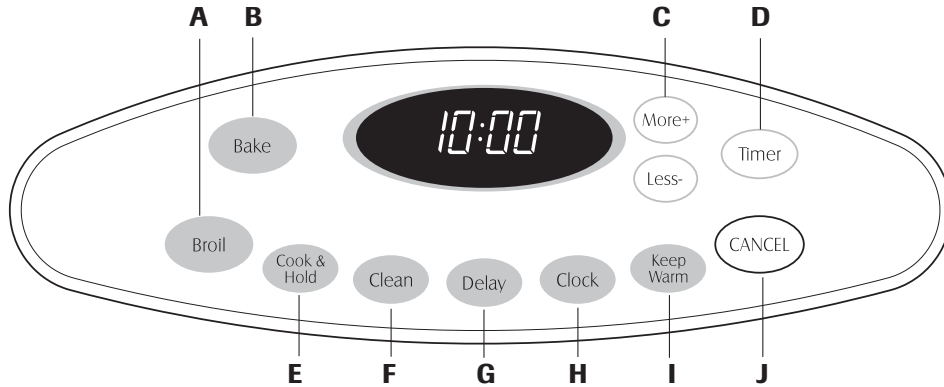

The control panel is designed for ease in programming. The display window on the control shows time of day, timer and oven functions. Control panel shown includes model specific features. (Styling may vary depending on model.)

<b>A</b>	Broil	Use for broiling and top browning.
<b>B</b>	Bake	Use for baking and roasting.
<b>C</b>	More+ or Less-	Enters or changes time, oven temperature. Sets HI or LO broil.
<b>D</b>	Timer	Sets Timer.
<b>E</b>	Cook & Hold	Bakes for a preset time, then holds food warm for 1 hour.
<b>F</b>	Clean	Use to set self-clean cycle.
<b>G</b>	Delay	Programs the oven to start baking at a later time.
<b>H</b>	Clock	Use to set time-of-day clock.
<b>I</b>	Keep Warm	Use to keep cooked food warm in oven.
<b>J</b>	CANCEL	Cancels all operations except Timer and Clock.

### Using the Touchpads

- Press the desired pad.
- Press the More+ or Less- pad to enter time or temperature.
- A beep will sound when any pad is touched.
- A double beep will sound if a programming error occurs.

**Note:** Four seconds after pressing the More+ or Less- pad, the time or temperature will automatically be entered. If more than 30 seconds elapse between touching a function pad and the More+ or Less- pad, the function will be canceled and the display will return to the previous display.

### Clock

The clock can be set to display time in a 12-hour or 24-hour format. The clock is set at the factory for the 12-hour format.

#### To change the clock to 24-hour format:

1. Press and hold the CANCEL and Delay pads for three seconds.
2. Press the More+ or Less - pad to select 12 or 24 hour.
3. Set the time of day following the directions below.

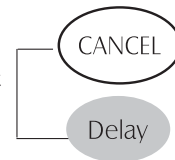

#### To set the Clock:

1. Press the Clock pad.
  - Time of day and the colon flash in the display.
2. Press the More+ or Less- pad to set the time of day.
  - Colon continues flashing.
3. Press the Clock pad again or wait four seconds.

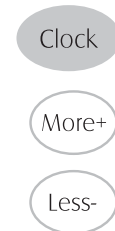

When electrical power is supplied or after a power interruption, the last clock time before power was interrupted will flash.

To recall the time of day when another time function is showing, press the Clock pad.

Clock time cannot be changed when the oven has been programmed for cook or clean Delay or Cook & Hold.



# Use and Care Guide

## **Oven Cooking**

### To cancel the Clock display:

If you do not want the time of day to display:

Press and hold the CANCEL and Clock pads for three seconds. The time of day will disappear from the display

When the clock display is canceled, press the Clock pad to briefly display the time of day.

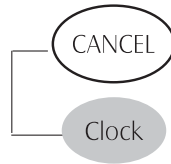

### To restore the Clock display:

Press and hold the CANCEL and Clock pads for three seconds. The time of day will reappear in the display.

## Timer

The timer can be set from one minute (00:01) up to 99 hours and 59 minutes (99:59).

The timer can be used independently of any other oven activity. It can also be set while another oven function is operating.

The Timer does not control the oven. It only controls a beeper.

### To set the Timer:

1. Press the Timer pad.
  - 0:00 lights in the display.
  - The colon flashes in the display.
2. Press the More+ or Less- pad until the correct time appears in the display.
  - The colon will continue to flash.
3. Press Timer pad again or wait four seconds.
  - The colon continues flashing and the time begins counting down.
  - The last minute of the timer countdown will be displayed as seconds.
4. At the end of the set time, one long beep will sound.



### To cancel the Timer:

1. Press and hold the Timer pad for three seconds.  
OR
2. Press the Timer pad and set the time to 00:00.

## Locking the Control

The touchpad controls can be locked for safety, cleaning, or to prevent unwanted use. They will not function when locked.

If the oven is currently in use, the controls cannot be locked.

The current time of day will remain in the display when the controls are locked.

### To lock:

Press and hold the CANCEL and Cook & Hold pads for three seconds.

- LOCK flashes in the display.

### To unlock:

Press and hold the CANCEL and Cook & Hold pads for three seconds.

- LOCK disappears from the display.

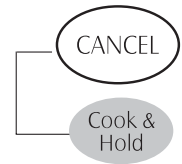

## Fault Codes

BAKE or LOCK may flash rapidly in the display to alert you if there is an error or a problem. If BAKE or LOCK flash in the display, press CANCEL pad. If BAKE or LOCK continue to flash, disconnect power to the appliance. Wait a few minutes, and then reconnect power. If the flashing still continues, disconnect power to the appliance and call an authorized servicer.



## Oven Cooking

### Baking

#### To set Bake:

1. Press the Bake pad.
  - “BAKE” will flash.
  - 000 will light in the display.
2. Select the oven temperature. The oven temperature can be set from 170° to 550°. Press or press and hold the More+ or Less- pads.
  - 350° will light when either pad is first pressed.
  - Press the More+ pad to increase the temperature.
  - Press the Less- pad to decrease the temperature.
3. Press Bake pad again or wait four seconds.
  - BAKE will stop flashing and light in the display.



4. Allow the oven to preheat for 8-15 minutes.
  - 100° or the actual oven temperature will display. The temperature will rise in 5° increments until the preset temperature is reached.
  - When the set oven temperature is reached, one long beep will sound.
  - To recall the set temperature during preheat, press the Bake pad.
5. Place food in center of oven, allowing a minimum of two inches between utensil and oven walls.
6. Check cooking progress. Cook longer if needed.
7. When cooking is finished, press CANCEL.
8. Remove food from the oven.

#### Baking Notes:

- **To change oven temperature during cooking**, press the Bake pad, then press the More+ or Less- pad until the desired temperature is displayed.
- **To change oven temperature during preheat**, press the Bake pad **twice**, then press the More+ or Less- pad until the desired temperature is displayed.
- If you forget to turn off the oven, it will automatically turn off at the end of 12 hours. If you wish to deactivate this feature, see page 13.
- For additional baking and roasting tips, see “Cooking Made Simple” booklet.

### Baking Differences Between Your Old and New Oven

It is normal to notice some baking time differences between a new oven and an old one. See “Adjusting the Oven Temperature” on page 13.

### Cook & Hold

**Cook & Hold** allows you to bake for a preset amount of time, followed by a one-hour Keep Warm cycle.

#### To set Cook & Hold:

1. Press the Cook & Hold pad.
  - “BAKE” and “HOLD” flash.
  - 000 lights in the display.
2. Select the oven temperature. The oven temperature can be set from 170° to 550°. Press or press and hold the More+ or Less- pad.
  - Press the More+ pad to increase the temperature.
  - Press the Less- pad to decrease the temperature.
3. Press Cook & Hold again OR wait four seconds.
  - “HOLD” flashes.
  - 00:00 flashes in the display.
4. Enter the amount of time you want to bake by pressing the More+ or Less- pad. Bake time can be set from ten minutes (00:10) to 11 hours, 59 minutes (11:59).
  - “BAKE” and “HOLD” light in the display.
  - The baking time will light in the display.
  - The baking time will start counting down.

#### When the cooking time has elapsed:

- Four beeps will sound.
- “BAKE” will turn off.
- “HOLD” and “WARM” will light.
- 170° will display.



#### After one hour in HOLD WARM:

- “End” will display.
- The time of day reappears in the display.

#### To cancel Cook & Hold at any time:

Press the CANCEL pad. Remove food from oven.

## **Oven Cooking**

### Delay Bake

#### **CAUTION**

Do not use delayed baking for highly perishable foods such as dairy products, pork, poultry, or seafood.

When using **Delay**, the oven begins to cook later in the day. Set the amount of time that you want to delay before the oven turns on and how long you want to cook. The oven begins to heat at the selected time and cooks for the specified length of time, then keeps food warm for up to one hour.

Delay time can be set from 10 minutes (00:10) to 11 hours, 59 minutes (11:59).

#### To set a Delayed Baking cycle:

1. Press the Delay pad.
    - “DELAY” flashes.
    - 00:00 flashes in the display.
  2. Press the More+ or Less- pad to set the delay time.
- While “DELAY” is still flashing:
3. Press the Cook & Hold pad.
    - 000 lights in the display.
    - “BAKE” and “HOLD” flash.
  4. Press More+ pad to set the baking temperature.
    - 00:00 and “HOLD” flash.
    - “BAKE” stays lit.
  5. Press More+ pad to set the baking time.
    - The Delay time, “DELAY”, “BAKE” and “HOLD” light in the display.



#### When the Delay time has expired:

- “DELAY” will turn off.
- Baking time is displayed.
- “BAKE” and “HOLD” are displayed.

#### To set a Delay when Cook & Hold has already been programmed:

1. Press the Delay pad.
  - “DELAY” flashes.
  - 00:00 appears in the display.
2. Press the More+ or Less- pad to set the delay time.
  - After four seconds, “DELAY” will stay lit to remind you that a delayed cooking cycle has been set.

Delay

More+

Less-

#### When the Delay time has expired and the oven starts:

- The baking time will be displayed.
- “DELAY” will turn off.
- “BAKE” and “HOLD” will remain lit.

#### To cancel:

Press the CANCEL pad.

- All timed and untimed cooking functions will be canceled.
- The time of day will reappear in the display.

CANCEL

#### Notes:

- Do not use delayed baking for items that require a preheated oven, such as cakes, cookies, and breads.
- Do not use delayed baking if oven is already hot.

# Use and Care Guide



## Oven Cooking

### Keep Warm

For safely keeping foods warm or for warming breads and plates.

#### To set Keep Warm:

1. Press the Keep Warm pad.
  - “WARM” flashes.
  - 000 appears in the display.
2. Select the Keep Warm temperature. The Keep Warm temperature can be set from 145° to 190°. Press or press and hold the More+ or Less- pad.
  - 170° will light when either pad is first pressed.
  - Press the More+ pad to increase the temperature.
  - Press the Less- pad to decrease the temperature.“WARM” and the temperature will be displayed while Keep Warm is active.



#### To cancel Keep Warm:

1. Press the CANCEL pad.
2. Remove food from the oven.



#### Keep Warm Notes:

- For optimal food quality, oven cooked foods should be kept warm for no longer than 1 to 2 hours.
- To keep foods from drying, cover loosely with foil or a lid.
- **To warm dinner rolls:**
  - cover rolls loosely with foil and place in oven.
  - press Keep Warm and More+ pads to set 170° F.
  - warm for 12-15 minutes.
- **To warm plates:**
  - place 2 stacks of up to four plates each in the oven.
  - press Keep Warm and More+ pads to set 170° F.
  - warm for five minutes, turn off the oven and leave plates in the oven for 15 minutes more.
  - use only oven-safe plates, check with the manufacturer.
  - do not set warm dishes on a cold surface as rapid temperature changes could cause crazing or breakage.

# Use and Care Guide



## Oven Cooking

### Automatic Shut-Off/Sabbath Mode

The oven will automatically turn off after 12 hours if you accidentally leave it on. This safety feature can be turned off.

#### To cancel the 12-hour shut-off and run the oven continuously for 72 hours:

1. Set the oven to bake (see page 10).
2. Press and hold the Clock pad for five seconds.
  - SAb will be displayed and flash for five seconds.
  - SAb will then be displayed continuously until turned off or until the 72-hour time limit is reached.
  - “BAKE” will also be displayed if a bake cycle is in use while the oven is in Sabbath Mode.

All other functions EXCEPT BAKE (Timer, Keep Warm, Clean, etc.) are locked out during the Sabbath Mode.

#### To cancel Bake when in Sabbath Mode:

Press CANCEL.

- “BAKE” will turn off in the display.
- No beeps will sound.

#### To cancel the Sabbath Mode:

1. Press the Clock pad for five seconds.  
OR
2. After 72 hours, the Sabbath Mode will end.
  - SAb will flash for five seconds.
  - The time of day will return to the display.

### Adjusting the Oven Temperature

Oven temperatures are carefully tested for accuracy at the factory. It is normal to notice some baking or browning differences between a new oven and an old one. As ranges get older, the oven temperature can shift.

You may adjust the oven temperature if you think the oven is not baking or browning correctly. To decide how much to change the temperature, set the temperature 25° higher or lower than your recipe recommends, then bake. The results of the “test” should give you an idea of how much to adjust the temperature.

#### To adjust the oven temperature:

1. Press Bake.
2. Enter 550° by pressing the More+ pad.
3. Press and hold the Bake pad for several seconds or until 0° appears in the display.
4. Press the More+ or Less- pad to adjust the temperature.
5. The time of day will automatically reappear in the display.

If the oven temperature was previously adjusted, the change will be displayed. For example, if the oven temperature was reduced by 15° the display will show “-15”.

Each time a pad is pressed, the temperature changes by 5°. The oven temperature can be increased or decreased by 5° to 35°.

You do not need to readjust the oven temperature if there is a power failure or interruption. Broiling and cleaning temperatures cannot be adjusted.

#### Sabbath Mode Notes:

- Sabbath Mode can be turned on at any time with or without the oven on.
- Sabbath Mode cannot be turned on if the touchpads are locked out or when the door is locked.
- If the oven is baking when Sabbath Mode is set, “BAKE” will go out at the end of the baking cycle. There will be no audible beeps.
- When the Sabbath Mode is started, no preheat beep will sound.
- All prompts, messages and beeps are deactivated when Sabbath Mode is active.
- Pressing CANCEL will cancel a Bake cycle, however the control will stay in the Sabbath Mode.
- If power fails, the oven will power up in Sabbath Mode with 72 hours remaining and no cycle active.

# Use and Care Guide



## Oven Cooking

### Broiling

#### To set Broil:

- Press the Broil pad.
  - “BROIL” flashes.
  - SET is displayed.
- Press the More+ pad to set HI broil or press the Less- pad to set LO broil.
  - HI or LO will be displayed.
  - Select HI broil (550° F) for normal broiling. Select LO broil (450° F) for low-temperature broiling of longer cooking foods such as poultry.
- After four seconds, the oven will start.
  - “BROIL” will remain lit.



- For optimum browning, preheat broil element for 3-4 minutes before adding food.
- Place food in the oven. Leave oven door open about four inches (the first stop).

- Turn meat once about halfway through cooking.
- When food is cooked, press the CANCEL pad. Remove food and broiler pan from the oven.
  - The time of day will reappear in the display.



#### Broil Notes:

- For best results when broiling, use a pan designed for broiling.
- Expect broil times to increase and browning to be slightly lighter if appliance is installed on a 208-volt circuit.
- HI is used for most broiling. Use LO broil when broiling longer cooking foods. The lower temperature allows food to cook to the well done stage without excessive browning.
- Broil times may be longer when the lower broiling temperature is selected.
- Food should be turned halfway through broiling time.
- For additional broiling tips and temperatures, refer to the “Cooking Made Simple” booklet.

### Broiling Chart

FOODS	RACK POSITION*	DONENESS	TOTAL COOK TIME
<b>Beef</b>			
Steak, 1” thick	4	Medium	15 - 18 minutes
Hamburgers, 3/4” thick	4	Well Done	19 - 23 minutes
	4	Well Done	15 - 18 minutes
<b>Pork</b>			
Bacon	4	Well Done	6 - 10 minutes
Chops, 1”	4	Well Done	22 - 26 minutes
Ham - precooked slice, 1/2” thick	4	Warm	8 - 12 minutes
<b>Poultry</b>			LO Broil
Chicken Pieces	3 or 4	Well Done	28 - 38 minutes
<b>Seafood</b>			
Fish Steaks, buttered, 1” thick	4	Flaky	10 - 15 minutes
Fillets	4	Flaky	8 - 12 minutes

\* The top rack position is #5.

**Note:** This chart is a suggested guide. The times may vary with the food being cooked.

# Use and Care Guide

## **Oven Cooking**

### Oven Vent

When the oven is in use the area near the vent may become hot enough to cause burns. Never block the vent opening.

**The oven vent is located below the backguard vent shield on your range.**

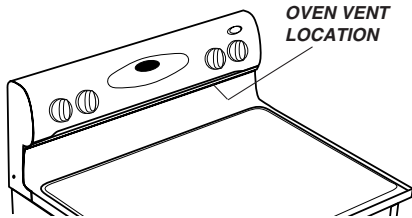

Do not place plastics near the vent opening as heat from the vent could distort or melt the plastic.

### Oven Light

Press the Oven Light switch on the control panel to turn the oven light on and off.



Oven Light

### Oven Bottom

Protect oven bottom against spillovers, especially acidic or sugary spills, as they may discolor the porcelain enamel. Use the correct pan size to avoid spillovers and boilovers. **Do not place utensils or aluminum foil directly on the oven bottom.**

### Oven Racks

#### **CAUTION**

- Do not attempt to change the rack position when the oven is hot.
- Do not use the oven for storing food or cookware.

The oven has two racks. All racks are designed with a lock-stop edge.

#### To remove:

1. Pull rack straight out until it stops at the lock-stop position.
2. Lift up on the front of the rack and pull out.

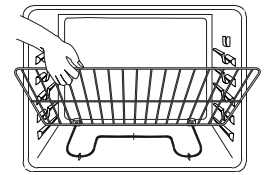

#### To replace:

1. Place rack on the rack supports in the oven.
2. Tilt the front end up slightly. Slide rack back until it clears the lock-stop position.
3. Lower front and slide back into the oven.

**Do not cover an entire rack with aluminum foil or place foil on the oven bottom. Baking results will be affected and damage may occur to the oven bottom.**

### Rack Positions

**RACK 5** (highest position): Used for toasting bread or broiling thin, non-fatty foods.

**RACK 4:** Used for most broiling.

**RACK 3:** Used for most baked goods on a cookie sheet or jelly roll pan, layer cakes, fruit pies, or frozen convenience foods.

**RACK 2:** Used for roasting small cuts of meat, casseroles, baking loaves of bread, bundt cakes or custard pies.

**RACK 1:** Used for roasting large cuts of meat and poultry, frozen pies, dessert souffles or angel food cake.

#### MULTIPLE RACK COOKING:

**Two flat racks:** Use rack positions 2 and 4.

**One flat rack and one offset rack:** Use rack positions 2 and 5.

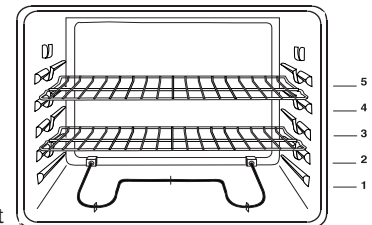

**Note:** Use caution when removing the offset rack from position 1 (lowest position).

# Use and Care Guide



## Oven Cooking

### Create-A-Space™ Half Rack

Select range models are equipped with a convertible half rack. The left side of the rack can be removed to accommodate a large roaster on the lower rack. The right side of the rack is still available to hold a casserole dish.

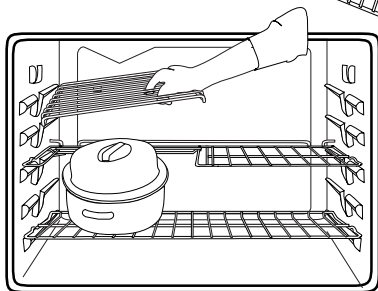
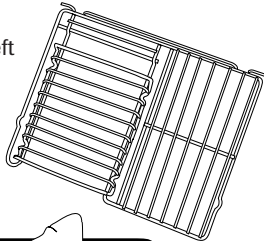

#### Notes:

- The removable section of the rack can be used as a roasting rack in the broiling pan. Do not use the top insert when using the rack in the broiling pan.
- The removable section of the rack can be used as a cooling rack or trivet.
- Make sure oven is cool before removing or reinstalling the half rack.
- Do not use cookware that extends beyond edge of rack.
- For best results, allow two inches between the pan placed on the rack and the oven side wall.
- Use caution when removing items from the half rack to avoid burns.
- Carefully remove items from the lower rack to avoid disturbing the half rack.

### EasyRack™ (select models)

Select range models are equipped with an EasyRack™. This rack offers a convenient place to grasp bakeware when taking it out of the oven.

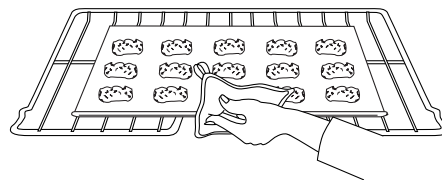
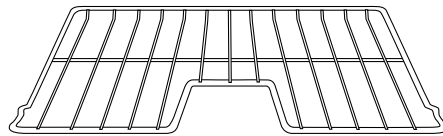

#### Notes:

- Use the EasyRack™ only in the oven in which it was purchased.
- The EasyRack™ can be used in all rack positions.



# Use and Care Guide

## Care & Cleaning

### Self-Clean Oven

#### CAUTION

- It is normal for parts of the range to become hot during a self-clean cycle.
- To prevent personal injury and damage to the oven door do not attempt to open door when "LOCK" is displayed.
- Avoid touching cooktop, door, window or oven vent area during a clean cycle.
- Do not use commercial oven cleaners on the oven finish or around any part of the oven. They will damage the finish or parts.

The self-clean cycle uses above-normal cooking temperatures to automatically clean the oven interior. Do not force the oven door or lock lever open. This may result in exposure to high temperatures and be a burn hazard.

It is normal for flare-ups, smoking, or flaming to occur during cleaning if the oven is heavily soiled. It is better to clean the oven regularly rather than to wait until there is a heavy build-up of soil in the oven.

During the cleaning process, the kitchen should be well ventilated to get rid of normal odors associated with cleaning.

#### Before Self-Cleaning

1. Turn off the oven light before cleaning. The light may burn out during the clean cycle.
2. Remove broiler pan, all pans, and oven racks from the oven. The oven racks will discolor and may not slide easily after a self-clean cycle if they are not removed.
3. Clean oven frame, door frame, area outside of gasket, and around the opening in the door gasket with a nonabrasive cleaner such as Bon Ami\* or detergent and water. The self-cleaning process does not clean these areas. They should be cleaned to prevent soil from baking on during the clean cycle. (The gasket is the seal around the oven door and window.)
4. To prevent damage, do not clean or rub the gasket around the oven door. The gasket is designed to seal in heat during the clean cycle.
5. Wipe up excess grease or spillovers from the oven bottom. This prevents excessive smoking, flare-ups or flaming during the clean cycle.

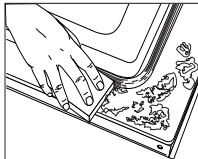

6. Wipe up sugary and acidic spillovers such as sweet potatoes, tomato, or milk-based sauces. Porcelain enamel is acid-resistant, not acid-proof. The porcelain finish may discolor if acidic spills are not wiped up before a self-clean cycle.

#### To set Self-Clean:

**Note:** Oven temperature must be below 400° F to program a clean cycle.

1. Close the oven door.
2. Move door lock lever right to the locked position.



3. Press the Clean pad.
  - "CLEAN" flashes in the display.

Clean

If the door is not closed, beeps will sound and "DOOR" will display. If the door is not closed within 45 seconds, the self-cleaning operation will be canceled and the display will return to the time of day.

4. Press the More+ or Less- pad.
  - "CL-M" (Medium Soil, 3 hours) is displayed.
5. Press the More+ or Less- pad to scroll through the self-cleaning settings.

More+

CL-H" (Heavy Soil, 4 hours)  
CL-M" (Medium soil, 3 hours)  
CL-L" (Light Soil, 2 hours)

Less-

Choosing the soil level of the oven automatically programs the self-cleaning time.

6. After four seconds, the oven will start cleaning.
  - The cleaning time will start counting down in the display.
  - "LOCK" will appear in the display.
  - "CLEAN" will appear in the display.

#### To Delay a Self-Clean Cycle:

1. Press the Delay pad.
  - "DELAY" flashes.
  - 00:00 will appear in the display.
2. Press the More+ or Less- pad to set the amount of time you want to delay the cycle. Delay time can be set from ten minutes (00:10) to 11 hours, 59 minutes (11:59).

Delay

More+

cont.

\* Brand names for cleaning products are registered trademarks of the respective manufacturers.

# Use and Care Guide

## Care & Cleaning

3. Press the Clean pad.

- “CLEAN” will flash.

Clean

4. Press the More+ or Less- pad.

- “CL-M” (Medium Soil, 3 hours) is displayed.

More+

5. Press the More+ or Less- pad to scroll through the self-cleaning settings.

CL-H” (Heavy Soil, 4 hours)

CL-M” (Medium soil, 3 hours)

CL-L” (Light Soil, 2 hours)

Choosing the soil level of the oven automatically programs the self-cleaning time.

6. After four seconds, CLEAN, DELAY and LOCK will appear in the display to show that the oven is set for a delayed clean operation. The delay time is displayed.



### If the oven has already been set for a clean cycle and you wish to set a delay:

1. Press the Delay pad.

- “DELAY” flashes.

- 00:00 will appear in the display.

Delay

2. Press the More+ or Less- pad to set the amount of time you want to delay the cycle.

After four seconds, CLEAN, DELAY and LOCK will appear in the display to show that the oven is set for a delayed clean operation. The delay time is displayed.

More+

### When the Self-Clean cycle starts:

- “DELAY” will turn off.

- The clean time will appear in the display.

### To cancel the Self-Clean cycle:

Press the CANCEL pad.

- All words disappear from the display.

- All functions are canceled.

- The time of day appears in the display.

CANCEL

### During the Self-Clean Cycle

When LOCK shows in the display, the door cannot be opened. To prevent damage to the door, do not force the door open when LOCK is displayed.

### Smoke and Smells

You may see some smoke and smell an odor the first few times the oven is cleaned. This is normal and will lessen in time.

Smoke may also occur if the oven is heavily soiled or if a broiler pan was left in the oven.

### Sounds

As the oven heats, you may hear sounds of metal parts expanding and contracting. This is normal and will not damage the oven.

### After Self-Cleaning

About one hour after the end of the self-clean cycle, LOCK will turn off. The door can then be opened. Move door lock lever to the left to unlock.

**Some soil may leave a light gray, powdery ash.** Remove it with a damp cloth. If soil remains after wiping, that means the clean cycle was not long enough. The soil will be removed during the next clean cycle.

**If oven racks were left in the oven and do not slide smoothly after a clean cycle,** wipe racks and rack supports with a small amount of vegetable oil to make them easier to move.

**Fine lines may appear in the porcelain because it went through heating and cooling.** This is normal and will not affect performance.

**A white discoloration may appear after cleaning if acidic or sugary foods were not wiped up before the self-clean cycle.** This discoloration is normal and will not affect performance.

### Notes:

- If the oven door is left open, “DOOR” will flash in the display and a signal will beep until the door is closed and the Clean pad is pressed again.
- If more than five seconds elapse between pressing the Clean pad and the More+ or Less- pad, the program will automatically return to the previous display.
- The oven door will be damaged if the oven door is forced to open when “LOCK” is still displayed.

# Use and Care Guide

## Care & Cleaning

### Cleaning Procedures

#### CAUTION

- Be sure appliance is off and all parts are cool before handling or cleaning. This is to avoid damage and possible burns.
- To prevent staining or discoloration, clean appliance after each use.
- If a part is removed, be sure it is correctly replaced.

\* Brand names are registered trademarks of the respective manufacturers.

\*\* To order call 1-877-232-6771 USA and 1-800-688-8408 Canada.

PART	PROCEDURE
<b>Backguard and Cooktop – Porcelain Enamel</b>	<p>Porcelain enamel is glass fused on metal and may crack or chip with misuse. It is acid resistant, not acid proof. All spillovers, especially acidic or sugary spillovers, should be wiped up immediately with a dry cloth.</p> <ul style="list-style-type: none"> <li>• When cool, wash with soapy water, rinse and dry.</li> <li>• Never wipe off a warm or hot surface with a damp cloth. This may cause cracking or chipping.</li> <li>• Never use oven cleaners, abrasive or caustic cleaning agents on exterior finish of range.</li> </ul>
<b>Broiler Pan and Insert</b>	<p><b>Never cover insert with aluminum foil as this prevents the fat from draining to the pan below.</b></p> <ul style="list-style-type: none"> <li>• Place soapy cloth over insert and pan; let soak to loosen soil.</li> <li>• Wash in warm soapy water. Use scouring pad to remove stubborn soil.</li> <li>• Broiler pan and insert can be cleaned in dishwasher.</li> </ul>
<b>Clock and Control Pad Area</b>	<ul style="list-style-type: none"> <li>• To activate “Control Lock” for cleaning, see page 9.</li> <li>• Wipe with a damp cloth and dry. Do not use abrasive cleaning agents as they may scratch the surface.</li> <li>• Glass cleaners may be used if sprayed on a cloth first. <b>DO NOT spray directly on control pad and display area.</b></li> </ul>
<b>Control Knobs</b>	<ul style="list-style-type: none"> <li>• Remove knobs in the OFF position by pulling forward.</li> <li>• Wash, rinse and dry. Do not use abrasive cleaning agents as they may scratch the finish.</li> <li>• Turn on each element to be sure the knobs have been correctly replaced.</li> </ul>
<b>Cooktop – Glass-Ceramic</b>	<p><b>Never use oven cleaners, chlorine bleach, ammonia or glass cleaners with ammonia. NOTE: Call an authorized servicer if the glass-ceramic top should crack, break or if metal or aluminum foil should melt on the cooktop.</b></p> <ul style="list-style-type: none"> <li>• Allow the cooktop to cool before cleaning.</li> <li>• <b>General</b> – Clean cooktop after each use, or when needed, with a damp paper towel and Cooktop Cleaning Creme* (Part No. 20000001)**. Then, buff with a clean dry cloth.</li> </ul> <p><b>NOTE: Permanent stains will develop if soil is allowed to cook on by repeatedly using the cooktop when soiled.</b></p> <ul style="list-style-type: none"> <li>• <b>Heavy Soils or Metal Marks</b> – Dampen a “scratchless” or “never scratch” scrubber sponge. Apply Cooktop Cleaning Creme* (Part No. 20000001)** and scrub to remove as much soil as possible. Apply a thin layer of the creme over the soil, cover with a damp paper towel and let stand 30 to 45 minutes (2-3 hours for very heavy soil). Keep moist by covering the paper towel with plastic wrap. Scrub again, then buff with a clean dry cloth.</li> </ul> <p><b>NOTE: Only use a CLEAN, DAMP “scratchless” pad that is safe for non-stick cookware. The pattern and glass will be damaged if the pad is not damp, if the pad is soiled, or if another type of pad is used.</b></p> <ul style="list-style-type: none"> <li>• <b>Burned-on or Crusty Soils</b> – Scrub with a “scratchless” or “never scratch” scouring pad and Cooktop Cleaning Creme*.</li> </ul> <p><b>NOTE: Hold a razor blade scraper at 30° angle and scrape any remaining soil. Then, clean as described above. Do not use the razor blade for daily cleaning as it may wear the pattern on the glass.</b></p> <ul style="list-style-type: none"> <li>• <b>Melted Sugar or Plastic</b> – Immediately turn element to LOW and scrape sugar or plastic from hot surface to a cool area. Then turn element OFF and allow to cool. Clean residue with razor blade scraper and Cooktop Cleaning Creme*.</li> </ul> 

# Use and Care Guide



## Care & Cleaning

PART	PROCEDURE
<b>Oven Window and Door – Glass</b>	<ul style="list-style-type: none"> <li>• Avoid using excessive amounts of water which may seep under or behind glass causing staining.</li> <li>• Wash with soap and water. Rinse with clear water and dry. Glass cleaner can be used if sprayed on a cloth first.</li> <li>• Do not use abrasive materials such as scouring pads, steel wool or powdered cleaners as they will scratch glass.</li> </ul>
<b>Oven Interior</b>	<ul style="list-style-type: none"> <li>• Follow instructions on pages 17-18 to set a self-clean cycle.</li> </ul>
<b>Oven Racks</b>	<ul style="list-style-type: none"> <li>• Clean with soapy water.</li> <li>• Remove stubborn soil with cleansing powder or soap-filled scouring pad. Rinse and dry.</li> <li>• Racks will permanently discolor and may not slide smoothly if left in the oven during a self-clean operation. If this occurs, wipe the rack edge and rack support with a small amount of vegetable oil to restore ease of movement, then wipe off excess oil.</li> </ul>
<b>Stainless Steel</b> (select models)	<ul style="list-style-type: none"> <li>• <b>DO NOT USE ANY CLEANING PRODUCT CONTAINING CHLORINE BLEACH.</b></li> <li>• <b>DO NOT USE ABRASIVE OR ORANGE CLEANERS.</b></li> <li>• <b>ALWAYS WIPE WITH THE GRAIN WHEN CLEANING.</b></li> <li>• <b>Daily Cleaning/Light Soil</b> -- Wipe with one of the following - soapy water, white vinegar/water solution, Formula 409 Glass and Surface Cleaner* or a similar glass cleaner - using a sponge or soft cloth. Rinse and dry. To polish and help prevent fingerprints, follow with Stainless Steel Magic Spray (Part No. 20000008)**.</li> <li>• <b>Moderate/Heavy Soil</b> -- Wipe with one of the following - Bon Ami, Smart Cleanser, or Soft Scrub* - using a damp sponge or soft cloth. Rinse and dry. Stubborn soils may be removed with a damp multi-purpose Scotch-Brite* pad; rub evenly with the grain. Rinse and dry. To restore luster and remove streaks, follow with Stainless Steel Magic Spray*.</li> <li>• <b>Discoloration</b> -- Using a damp sponge or soft cloth, wipe with Cameo Stainless Steel Cleaner*. Rinse immediately and dry. To remove streaks and restore luster, follow with Stainless Steel Magic Spray*.</li> </ul>
<b>Storage Drawer, Door Handle, Side Panels – Painted Enamel</b>	<ul style="list-style-type: none"> <li>• When cool, wash with warm soapy water, rinse and dry. Never wipe a warm or hot surface with a damp cloth as this may damage the surface and may cause a steam burn.</li> <li>• For stubborn soil, use mildly abrasive cleaning agents such as baking soda paste or Bon Ami.* Do not use abrasive, caustic or harsh cleaning agents such as steel wool pads or oven cleaners. These products will scratch or permanently damage the surface.</li> </ul> <p><b>NOTE: Use a dry towel or cloth to wipe up spills, especially acidic or sugary spills. Surface may discolor or dull if soil is not immediately removed. This is especially important for white surfaces.</b></p>

\* Brand names for cleaning products are registered trademarks of the respective manufacturers.

\*\* To order direct, call 1-877-232-6771 USA and 1-800-688-8408 Canada.

# Use and Care Guide

## Maintenance

### Oven Door

#### CAUTION

- **Do not** place excessive weight on or stand on an open oven door. This could cause the range to tip over, break the door, or injure the user.
- Do not attempt to open or close door or operate oven until door is properly replaced.
- Never place fingers between hinge and front oven frame. Hinge arms are spring mounted. If accidentally hit, the hinge will slam shut against oven frame and could injure your fingers.

**Note:** The oven door on a new range may feel “spongy” when it is closed. This is normal and will decrease with use.

#### To remove:

1. When cool, open the oven door to the first stop position (opened about four inches).
2. Grasp door at each side. Do not use the door handle to lift door.
3. Lift up evenly until door clears hinge arms.

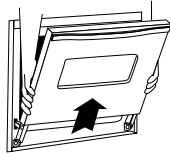

#### To replace:

1. Grasp door at each side.
2. Align slots in the door with the hinge arms on the range.
3. Slide the door down onto the hinge arms until the door is completely seated on the hinges. Push down on the top corners of the door to completely seat door on hinges. Door should not appear crooked.

### Oven Window

#### To protect the oven door window:

1. Do not use abrasive cleaning agents such as steel wool scouring pads or powdered cleansers as they may scratch the glass.
2. Do not hit the glass with pots, pans, furniture, toys, or other objects.
3. Do not close the oven door until the oven racks are in place.

Scratching, hitting, jarring or stressing the glass may weaken its structure causing an increased risk of breakage at a later date.

### Leveling Legs

#### CAUTION

Be sure the anti-tip bracket secures one of the rear leveling legs to the floor. This bracket prevents the range from accidentally tipping.

The range should be leveled when installed. If the range is not level, turn the plastic leveling legs, located at each corner of the range, until range is level.

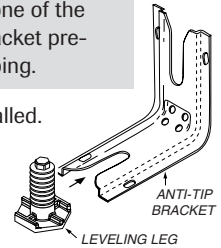

### Oven Light

#### CAUTION

- Disconnect power to range before replacing light bulb.
- Use a dry potholder to prevent possible harm to hands when replacing bulb.
- Be sure bulb is cool before touching bulb.
- Do not touch hot bulb with a damp cloth as this may cause the bulb to break.

#### To Replace Oven Light Bulb:

1. When oven is cool, hold bulb cover in place, then slide wire retainer off cover. **NOTE:** Bulb cover will fall if not held in place while removing wire retainer.
2. Remove bulb cover and light bulb.
3. Replace with a 40-watt appliance bulb.
4. Replace bulb cover and secure with wire retainer.
5. Reconnect power to range. Reset clock.

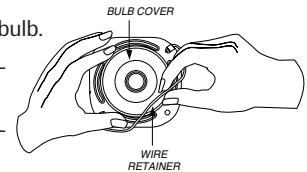

### Convenience Outlet

#### (Canadian models only)

The convenience outlet is located on the lower left side of the backguard. Be sure appliance cords do not rest on or near the surface element. If the surface element is turned on, the cord and outlet will be damaged.

The convenience outlet circuit breaker may trip if the small appliance plugged into it exceeds 10 amps. To reset the circuit breaker, press the switch located on the lower edge of the backguard.

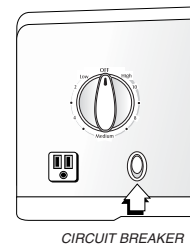

# Use and Care Guide



## Maintenance

### Storage Drawer

#### CAUTION

Do not store plastic, paper products, food or flammable materials in this drawer. The drawer may become too warm for these items when the oven is in use.

The storage drawer can be removed to allow you to clean under the range.

#### To remove:

1. Empty drawer and pull out to the first stop position.
2. Lift up the front of the drawer.
3. Pull out to the second stop position.
4. Grasp sides and lift drawer up and out.

#### To replace:

1. Fit the ends of the drawer glides into the rails in the range.
2. Lift up the front of the drawer and gently push in to the first stop position.
3. Lift drawer up again and push until drawer is closed.



## Troubleshooting

PROBLEM	SOLUTION
<b>For most concerns, try these first.</b>	<ul style="list-style-type: none"> <li>• Check if oven controls have been properly set.</li> <li>• Check to be sure plug is securely inserted into receptacle.</li> <li>• Check or re-set circuit breaker. Check or replace fuse.</li> <li>• Check power supply.</li> </ul>
<b>Part or all of appliance does not work.</b>	<ul style="list-style-type: none"> <li>• Check if surface and/or oven controls have been properly set. See pages 4 &amp; 10.</li> <li>• Check if oven door is unlocked after self-clean cycle. See page 18.</li> <li>• Check if oven is set for a delayed bake or clean program. See pages 11 &amp; 17.</li> <li>• Check if Control Lock is activated. See page 9.</li> <li>• Check if control is in Sabbath Mode. See page 13.</li> </ul>
<b>Clock, indicator words, and/or lights operate but oven does not heat.</b>	<ul style="list-style-type: none"> <li>• Oven may be set for a Cook &amp; Hold or Delay function.</li> <li>• The Control Lock may have been set. See page 9.</li> </ul>
<b>Baking results are not as expected or differ from previous oven.</b>	<ul style="list-style-type: none"> <li>• Make sure the oven vent has not been blocked. See page 15 for location.</li> <li>• Check to make sure range is level.</li> <li>• Temperatures often vary between a new oven and an old one. As ovens age, the oven temperature often "drifts" and may become hotter or cooler. See page 13 for instructions on adjusting the oven temperature. <b>NOTE:</b> It is not recommended to adjust the temperature if only one or two recipes are in question.</li> <li>• See "Cooking Made Simple" booklet for more information on bakeware and baking.</li> </ul>
<b>Food is not broiling properly or smokes excessively.</b>	<ul style="list-style-type: none"> <li>• Check oven rack positions. Food may be too close to element.</li> <li>• Broil element was not preheated.</li> <li>• Aluminum foil was incorrectly used. Never line the broiler insert with foil.</li> <li>• Oven door was closed during broiling. Leave the door open to the first stop position (about 4 inches).</li> <li>• Trim excess fat from meat before broiling.</li> <li>• A soiled broiler pan was used.</li> <li>• Voltage in house may be low.</li> </ul>

cont.

# Use and Care Guide

## **Troubleshooting**

<b>PROBLEM</b>	<b>SOLUTION</b>
<b>Oven will not self-clean.</b>	<ul style="list-style-type: none"> <li>• Check to make sure the cycle is not set for a delayed start. See page 17.</li> <li>• Check if door is closed.</li> <li>• Check if control is in Sabbath Mode. See page 13.</li> <li>• Oven may be over 400° F. Oven temperature must be below 400° F to program a clean cycle.</li> </ul>
<b>Oven did not clean properly.</b>	<ul style="list-style-type: none"> <li>• Longer cleaning time may be needed.</li> <li>• Excessive spillovers, especially sugary and/or acidic foods, were not removed prior to the self-clean cycle.</li> </ul>
<b>Oven door will not unlock after self-clean cycle.</b>	<ul style="list-style-type: none"> <li>• Oven interior is still hot. Allow about one hour for the oven to cool after the completion of a self-clean cycle. The door can be opened when the LOCK indicator word is not displayed.</li> <li>• The control and door may be locked. See pages 9 and 18 to unlock.</li> </ul>
<b>Smoothtop surface shows wear.</b>	<ol style="list-style-type: none"> <li>1. Tiny scratches or abrasions. <ul style="list-style-type: none"> <li>• Make sure cooktop and pan bottom are clean. Do not slide glass or metal pans across top. Make sure pan bottom is not rough. Use the recommended cleaning agents. See page 19.</li> </ul> </li> <li>2. Metal marks. <ul style="list-style-type: none"> <li>• Do not slide metal pans across top. When cool, clean with Cooktop Cleaning Creme. See page 19.</li> </ul> </li> <li>3. Brown streaks and specks. <ul style="list-style-type: none"> <li>• Remove spills promptly. Never wipe with a soiled cloth or sponge. Make sure cooktop and pan bottom are clean.</li> </ul> </li> <li>4. Areas with a metallic sheen. <ul style="list-style-type: none"> <li>• Mineral deposits from water and food. Use recommended cleaning agents. See page 19.</li> </ul> </li> <li>5. Pitting or flaking. <ul style="list-style-type: none"> <li>• Remove sugary boilovers promptly. See page 19.</li> </ul> </li> </ol>
<b>Moisture collects on oven window or steam comes from oven vent.</b>	<ul style="list-style-type: none"> <li>• This is normal when cooking foods high in moisture.</li> <li>• Excessive moisture was used when cleaning the window.</li> </ul>
<b>There is a strong odor or light smoke when oven is turned on.</b>	<ul style="list-style-type: none"> <li>• This is normal for a new range and will disappear after a few uses. Initiating a clean cycle will “burn off” the odors more quickly.</li> <li>• Turning on a ventilation fan will help remove the smoke and/or odor.</li> <li>• Excessive food soils on the oven bottom. Use a self-clean cycle.</li> </ul>
<b>Fault Codes</b>	<ul style="list-style-type: none"> <li>• BAKE or LOCK may flash rapidly in the display to alert you if there is an error or a problem. If BAKE or LOCK appear in the display, press CANCEL pad. If BAKE or LOCK continue to flash, disconnect power to the appliance. Wait a few minutes, and then reconnect power. If the flashing still continues, disconnect power to the appliance and call an authorized servicer.</li> <li>• If the oven is heavily soiled, excessive flareups may result in a fault code during cleaning. Press the CANCEL pad and allow the oven to cool completely, wipe out excess soil, then reset the clean cycle. If the fault code reappears, contact an authorized servicer.</li> </ul>
<b>Noises may be heard.</b>	<ul style="list-style-type: none"> <li>• The oven makes several low level noises. You may hear the oven relays as they go on and off. This is normal.</li> <li>• As the oven heats and cools, you may hear sounds of metal parts expanding and contracting. This is normal and will not damage your appliance.</li> </ul>
<b>There are no beeps and no display.</b>	<ul style="list-style-type: none"> <li>• Oven may be in Sabbath Mode. See page 13.</li> </ul>
<b>“SAb” flashing and then displayed continuously.</b>	<ul style="list-style-type: none"> <li>• Oven is in Sabbath Mode. To cancel, press and hold the Clock pad for five seconds.</li> </ul>