

DishDrawer

MODELS

DD602 DD602I
DS602 DS602I

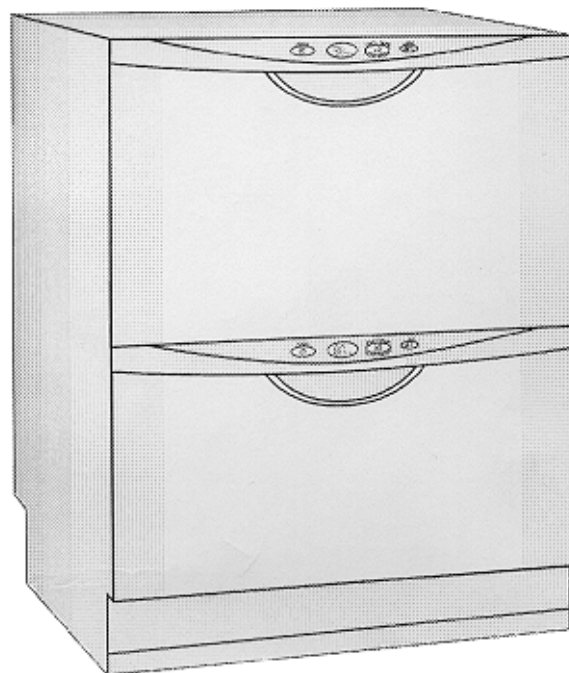

Fisher & Paykel Appliances Ltd
27 Hubble, Irvine, CA 92618
Tel: (949) 790 8900 (888) 936 7872
Fax: (949) 790 8913

CONTENTS

1.0 SERVICE REQUIREMENTS	5
1.1 HEALTH & SAFETY	5
1.1.1 Electrical Safety	5
1.1.2 Electrostatic Discharge	5
1.1.3 Good Working Practices	5
1.1.4 Isolate Water Supply	5
1.1.5 Water Leak Check	5
1.1.6 Insulation Test	6
1.1.7 Solvent and Excessive Heat Damage	6
1.1.8 Sheet Metal Edges	6
1.1.9 Diagnostics	6
1.2 SPECIALISED TOOLS	7
1.2.1 Static Strap:	7
1.2.2 Down Load Pen Connection: P/N 425930C	7
1.2.3 Down Load Serial Connection: P/N 425376C	7
1.2.4 Perspex Test Lid: P/N 525826	7
1.2.5 Air Gauge and Plumbing. P/N 525819	7
2.0 DIMENSIONS & SPECIFICATIONS	8
3.0 TECHNICAL OVERVIEW	10
3.1 ELECTRONICS	10
3.2 MOTOR	10
3.3 CABINET	10
3.3.1 Chassis	10
3.3.2 Drawer Fronts	11
3.4 FILLING	11
3.4.1 Cold Inlet	11
3.4.2 Mixing the Detergent	11
3.4.3 Amount of Water	11
3.5 DISPENSING DETERGENT	12
3.6 LID SEAL	12
3.6.1 When Activated	12
3.6.2 What is the Lid Seal	12
3.6.3 During Wash	12
3.7 WASH CYCLE	13
3.7.1 Tub	13
3.7.2 Rotor	13
3.7.3 Sprayarm	13
3.8 HEATING	13
3.8.1 The Element	13
3.8.2 Heating the Water	13
3.8.3 Maintaining the Temperature	13
3.8.4 Overheating Control	14
3.9 FILTER PLATE	14
3.9.1 The Filter System	14
3.9.2 Removing and Cleaning the Filter Plate	14
3.10 DRAIN CYCLE	14
3.11 DRYING CYCLE	15
3.12 DEFLATING	15
3.12.1 Lid Seal	15
3.12.2 When the Lid Seal Deflates	15
3.13 LOCKRING NUT	15

3.14	WIRING COVER.....	16
4.0	DIAGNOSTICS	16
4.1	SETUP & DIAGNOSTICS.....	16
4.2	FAULT MODES.....	16
4.3	DIAGNOSTIC MODES	17
4.3.1	Temperature Display Mode.....	17
4.3.2	Rinse Aid / Tub-Open Beep Water Pressure Setup Mode	17
4.3.3	Rinse Aid Setup.....	17
4.3.4	Tub-Open Beep Setup.....	17
4.3.5	Water Pressure Set Up.....	18
4.3.6	Dishwasher Diagnostics	18
4.3.7	Display / Download Mode	18
4.3.8	Optical LED Download / Fault Display	18
4.3.9	Clearing Fault Logs	19
4.3.10	Show Off Mode.....	19
4.3.11	Hardware Output Diagnostic Test Mode	19
4.3.12	Continuous Cycle Life Test Mode	20
4.4	DIAGNOSTICS QUICK REFERENCE FLOW CHART	22
4.4	DIAGNOSTICS QUICK REFERENCE FLOW CHART CONT'D.....	23
4.5	FAULT CODES	24
5.0	WIRING DIAGRAM	37
6.0	SERVICE PROCEDURES.....	38
6.1	DRAWER FRONT REMOVAL.....	38
6.2	HANDLE AND LCD DISPLAY REMOVAL.....	38
6.3	DRYING FAN REMOVAL	39
6.4	DETERGENT DISPENSER	39
6.5	ELECTRONIC CONTROLLER.....	40
6.6	TOP KICK STRIP REMOVAL	40
6.7	LOWER KICK STRIP REMOVAL	40
6.8	WIRING COVER REMOVAL	41
6.9	FILTER PLATE REMOVAL	41
6.10	ROTOR ASSEMBLY REMOVAL	41
6.11	TUB REMOVAL	42
6.12	LOCKING RING, ELEMENT PLATE AND MOTOR ASSEMBLY REMOVAL.....	42
6.13	LID ASSEMBLY REMOVAL	43
6.14	LID SEAL REPLACEMENT	43
6.15	SLIDE RUNNER REPLACEMENT.....	44
6.16	FRONT TRIM REPLACEMENT.....	44
6.17	SOUND GASKET REPLACEMENT	44
6.18	LINK ASSEMBLY REMOVAL	45
6.19	AIR PUMP REMOVAL.....	45
6.20	EXHAUST VALVE REMOVAL.....	46
6.21	WATER VALVE REMOVAL.....	46
6.22	FLOOD SWITCH REMOVAL.....	46
6.23	EMI FILTER REMOVAL.....	47
6.24	TUB MICROSWITCH REMOVAL	47

1.0 SERVICE REQUIREMENTS

1.1 Health & Safety

Note: When servicing the DishDrawer, health and safety issues must be considered at all times. Specific safety issues are listed below with their appropriate icon. These are illustrated throughout the service information to remind service people of the issues.

1.1.1 Electrical Safety



Ensure the mains power has been disconnected before servicing the DishDrawer. If the mains supply is required to be on to service the DishDrawer, make sure it is turned off when removing any electrical component or connection to avoid electrical shock.

1.1.2 Electrostatic Discharge

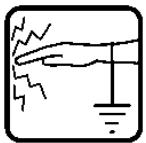

An anti-static strap is to be used as electrical static discharge (ESD) protection when servicing electronic components.

1.1.3 Good Working Practices



Ensure the work area is in a tidy and orderly condition at all times so as not to cause a hazard while service work is being completed. Always clean and tidy the DishDrawer and work area after service is completed.

1.1.4 Isolate Water Supply



Turn off the water connection tap before servicing.

1.1.5 Water Leak Check

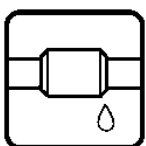

Check for water leaks as part of the testing after the service has been completed.

1.1.6 Insulation Test



Megger test to check insulation.

Warning: Short together the phase and neutral pins on the plug so as not to damage any electronic circuitry.

1.1.7 Solvent and Excessive Heat Damage



Plastic surfaces can be damaged by solvents and excessive heat.

1.1.8 Sheet Metal Edges



When working around cut sheet metal edges use appropriate gloves or protection to eliminate the chance of receiving a laceration.

1.1.9 Diagnostics



While in diagnostics some safety devices are bypassed. Ensure you do not run components unattended. They may overheat, flood, burnout or cause water damage.

1.2 Specialised Tools

For servicing this product Specialised tools are required.

1.2.1 Static Strap:

To be used as ESD protection when replacing or handling electronic components.

1.2.2 Down Load Pen Connection: P/N 425930C.

To be used to retrieve data from the electronic controller along with the diagnostic program on your laptop.

1.2.3 Down Load Serial Connection: P/N 425376C.

To be used to retrieve and download data from the electronic controller along with the diagnostic program on your laptop.

1.2.4 Perspex Test Lid: P/N 525826.

To be used on the drawer while extended to observe water fill, wash and drain operations.

1.2.5 Air Gauge and Plumbing. P/N 525819.

To be used to measure the air pressure in the lid seal and plumbing.

2.0 DIMENSIONS & SPECIFICATIONS

Description	Double		Single	
	Product Size	Minimum Cavity Size	Product Size	Minimum Cavity Size
Height	32 3/16 – 34 9/16	32 5/16 – 34 11/16	16 1/32"	16 5/32"
Width	23 5/8"	23 5/8"	23 7/16"	23 5/8"
Depth	22 15/32"	22 7/8"	22 7/16"	22 7/8"
Drawer Open (incl cab)	20 1/8"		20"	

Electrical 120V AC 60Hz 12amp max.

Specifications

Lid Seal P/N525878	4.5 PSI – 6 PSI	Detergent Dispenser P/N 525675	15-20 volt dc (pulsed) 70 ± 5 Ohms 0.18 ounces 0.36 ounces 0.54 ounces 0.18 ounces pre- rinse
Exhaust Valve P/N525415	9-12 Volt dc (pulsed) 70 ± 5 Ohms		
Lid Seal Air Pump P/N525430	3-6 Volt dc (pulsed) 16 ± 2 Ohms	Rinse Aid Dispenser	12-18 Volt dc (pulsed) 70 ± 5 Ohms .013 gal 25 reg. Washes approx
Water Inlet Valves P/N525113 Double P/N525842 Single	15-20 Volt dc (pulsed) 70 ± 5 Ohms 1.325 gal/min	Electronic P.C.B. P/N525832P	120 Volt ac Outputs:- 120 Volt ac 40 Volt dc 24 Volt dc
Flood Switch P/N525941	24Volt dc Double Pole	Control Panel Std P/N525192P	24 Volt dc
EMI Filter P/N525934	120 Volt ac	Control Panel Integrated P/N525185P	24 Volt dc
Motor Drain Wash	12-40 Volt dc 3 Phase 42000RPM 2300-2850RPM	Inlet Hose P/N525937	67 inches 139.2 PSI
Stator P/N525933	2.5 ± 0.2 Ohms per winding	Drain Hose P/N525435 P/N525495	78 13/16 inches from rear of cabinet 98 ½ bottom tub 114 ¼ top tub
Rotor P/N525736			
Temperature Sensor (Part of Heater Plate)	962-Ohms @ 68°F 1000-Ohms@ 86°F 1202-Ohms @ 140°F	Heater Plate P/N525814	110 Volt ac

3.0 TECHNICAL OVERVIEW

3.1 Electronics

The DD602 electronic controller has two separate micro controllers on the main printed circuit board. One is for motor control and output switching and the other is for controlling interface and console functions.

The user interface comprises a printed circuit board for front controls and a touch switch panel for internal controls.

The electronics can connect to a computer service tool via a serial communications port for fault finding and product information.

All output peripherals (solenoids, fans etc), except the heating element, are run on low voltage (24v).

The power for all low voltage devices comes from a 100w switchmode power supply, which is cooled by a heatsink and when necessary the drying fan.

The element is switched by a relay and protected by a fail-safe relay.

3.2 Motor

The motor is a fully electronically controlled 40V 60w 3 phase 6 pole brushless DC motor, running at approximately 2300-2850 depending on wash cycle selected, 2500 rpm on Normal, Fast, and Rinse cycles, 2300 on Delicate and 2850 on Heavy Wash, 4200 rpm on Drain.

3.3 Cabinet

3.3.1 Chassis

On the double drawer the double chassis is one complete assembly composed of 5 steel metal components locked together by a proprietary riveting process. The chassis exterior is made of white prepaint, while other components are made of electrogalvanised material. On the single drawer four bolts and washers are used to secure the chassis to the shelf using the steel inserts.

Unlike most other dishwashers, the chassis assembly is a load carrying structure designed to impart stiffness to the product and to ensure deflection is minimised.

The feet of the cabinet are assembled into the chassis by means of four steel inserts, which are clinched in place to form a permanent threaded connection.

The tub extends 20 inches out of the cabinet by travelling along two rigidly attached slides on either side of the tub.

3.3.2 Drawer Fronts

Prefinished drawer fronts are formed from a prepainted blank of steel. The drawer fronts are attached to the tub by means of formed hooks and two pins, which are inserted through either side of the tub.

On the integrated model, the front panel supplied on each drawer is the mounting panel for the joinery finished drawer front. The joinery finished drawer front is supplied by the customer.

3.4 Filling

3.4.1 Cold Inlet

The tub of the dishwasher fills by a cold water inlet hose only. From the connection to the cold water pipe in the kitchen, the inlet hose enters the cabinet of the dishwasher at the base, onto a dual water valve. Each tub is supplied water independently via one of the dual valve coils and a fill hose that runs through customised link assemblies at the back of the tub and travels along the base of the tub under the wiring cover to the front. At the front of the tub, the fill hose connects to the detergent dispenser which allows water to enter the tub, firstly through the pre rinse section of the dispenser for the pre rinse cycle and secondly through the main wash section for all other cycles.

3.4.2 Mixing the Detergent

Filling cold water enters the detergent dispenser, flushing the detergent from the cup, through the dispenser into the tub.

3.4.3 Amount of Water

The tub fills with approximately 0.7 gallons of water, level with the base of the sprayarm attachment. Once this level is reached, the wash pump (which has sensed the fill at 30-second intervals during the fill) becomes primed and pumps the water through the sprayarm, which will then rotate.

The water level is monitored by sensing the motor load through the electronics.

3.5 Dispensing Detergent

The dispenser is mounted in the front wall of the wash tub.

The detergent dispenser consists of two detergent chambers, one for pre wash and the other for the main wash.

The detergent dispenser door is opened manually for detergent loading and then manually closed ready for the detergent to be transported to the wash tub by the inlet water. To enable each detergent chamber to be dispensed separately, an inlet water diverter valve controlled by the electronics is necessary.

Additionally a positive displacement pump unit and storage tank are incorporated within the dispenser to supply rinse aid. The rinse aid dispensed volume is adjusted utilising the dishwasher electronic controller. A glowing red light on the tank filler cap indicates an empty rinse aid tank.

3.6 Lid Seal

3.6.1 When Activated

At the beginning of each wash cycle, the lid seal inflates while the pre drain cycle removes any residue water from the tub. This runs for approximately 60 seconds, then the tub fills.

3.6.2 What is the Lid Seal

The lid seal is a static plastic moulding retained in the lid, which provides a dynamic seal to the tub. The dynamic seal is created by a bellows section gasket bridging between the top flange of the tub and the lid. The dynamic seal also locks the tub/drawer during washing.

3.6.3 During Wash

The bellows section gasket is inflated by a solenoid activated diaphragm air pump. This cycles during the complete cycle at timed intervals to maintain a 3 psi sealing pressure.

3.7 Wash Cycle

3.7.1 Tub

The tub is the main cavity where all the wash activity occurs. The tub is a plastic receptacle which has a wash pump and sprayarm at the base. The tub also has guide vanes around its walls which direct falling water from the wash cycle in a clockwise direction around the filter plate. This clears the filter plate of food particles into the sump where they can be trapped or pumped out during the drain cycle.

3.7.2 Rotor

The rotor is a four-pole permanent magnet rotor with a graphite bearing at each end of the vertical shaft. At the lower end of the rotor shaft is the drain impellor and at the upper end is the wash impellor.

3.7.3 Sprayarm

The sprayarm is shaped for most efficient waterflow. The holes are positioned for best penetration into the washload, with the water jets angled to ensure the sprayarm rotates at the most efficient speed.

3.8 Heating

3.8.1 The Element

The heater plate is an element consisting of a porcelain enamelled steel plate with a thick film resistive circuit written onto the dry side. The element is clamped in place by a lockring nut and supports the motor at the base of the tub.

3.8.2 Heating the Water

The heater plate lies beneath the filter plate. This creates a flow through water heating system during the wash cycle by allowing water to flow through the filter plate, over the surface of the element and into the wash pump.

3.8.3 Maintaining the Temperature

Attached to the element is a sub printed circuit board with a temperature sensitive thermistor. This connects by means of a RAST 2.5 connector system to the wiring harness of the element. Sensor components are unserviceable.

3.8.4 Overheating Control

The heater plate is only activated during the wash cycles. It is not used for drying. The temperature is maintained by the thermistor. The element circuit is continuously monitored by the electronic controller and will switch a fail-safe relay if a fault is detected in the heater circuit. The element is thermally monitored by the thermistor on the element through the electronic controller.

3.9 Filter Plate

The filter plate is a stainless steel disk, which lies below the dishrack and sprayarm and completely encompasses the base of the tub.

3.9.1 The Filter System

The tub is designed with vanes, which swirl the water around and over the filter plate. At the front of the tub, located as part of the filter plate, is the drain filter. Large soils collect in the drain filter and only 1/16" or smaller soils flow through its micro mesh filter, eliminating re-depositing of soil during the wash. Only soils up to 1/4" pass through the drain filter during the drain cycle. This requires the drain filter to be regularly emptied and cleaned.

3.9.2 Removing and Cleaning the Filter Plate

The drain filter can be emptied with the dishrack in place by removing the cutlery basket and opening the plastic section of the dishrack. The filter plate is removable for cleaning by removing the dishrack and sprayarm and unlocking the locking nut anti-clockwise.

3.10 Drain Cycle

The drain pump is a self priming centrifugal pump which only pumps when the motor is rotating in the drain direction (anti-clockwise). It has a five bladed impellor made from acetal pushed into a spline on the end of the rotor shaft. The drain cycle is a 60 second timed drain period.

The drain pump housing, which incorporates an inlet and outlet pipe, is welded to the motor housing, hence captivating the motor.

The inlet pipe plugs straight into the sump and is sealed there by a small 'o' ring.

The outlet pipe has a non-return flap valve to prevent soiled water returning to the tub.

The drain hose is an extruded blow mould hose, which is routed over the link assembly and exits out of the base of the product and is connected to a domestic drain.

3.11 Drying Cycle

Immediately after water from the final hot rinse has been drained from the tub, the drying system begins operation.

The fan draws air through the tub, where it absorbs water from the dishload. The moisture laden air is then mixed with a larger quantity of ambient air (from the kitchen), to minimise the amount of vapour visible when exiting from the drawer front.

The fan runs continuously during the drying cycle and will restart if the tub is opened and closed again. After the drying cycle is complete, the fan continues to run for 30 minutes, but will not restart if the tub is opened.

The fan is pulsed when needed throughout the entire wash cycle. This draws ambient air through the electronics heatsink to maintain the electronics components within their specified operating temperatures.

3.12 Deflating

3.12.1 Lid Seal

The lid seal is a static plastic moulding retained in the lid, which provides a dynamic seal to the tub during the washing cycles.

3.12.2 When the Lid Seal Deflates

At the end of the dishwasher programme, or a pause in the programme, an exhaust valve releases the air pressure from the bellows section gasket. This deflates the seal and unlocks the tub and drawer.

3.13 Lockring Nut

The lockring nut holds the heater plate into the base of the tub and motor housing assembly to form a watertight seal. It does this by compressing two large 'o' rings between the heater plate and tub and between the heater plate and the motor assembly.

It has clips, which hold the drain hose, fill hoses and the wiring loom in place.

Another function of the lockring nut is to support the wiring cover with three clips.

3.14 Wiring Cover

The wiring cover protects the customer from the 120V mains supply which passes over the link assembly and under the lockring to the front of the tub. It also serves to protect the motor assembly, drain and fill hoses from damage when opening and closing drawers. The wiring cover acts as a cosmetic part of the product.

4.0 DIAGNOSTICS

4.1 Setup & Diagnostics

The DishDrawer comes with comprehensive fault codes and built in diagnostics, to save the user & service person time and worry, if the dishwasher ever exhibits a fault.

4.2 Fault Modes

The faults are displayed in the LCD as one of 10 F (fatal) faults or one of 10 U (user) faults. A Fatal fault will usually require the assistance of a qualified service person, while many User a faults are simply blockages or installation errors, easily fixed by the user. In the Integrated models, an LCD is not available, and faults are indicated by a Red center LED, with the fault number indicated on the touch switch panel with Red LED's. The indication below for the Touch Switch Panel is from left to right, with '_' meaning the LED is Off, and '#' meaning the LED is On. A fatal fault is accompanied by a continuous pulsating beep, while a user fault is accompanied by a more pleasant continuous pulsating tone pattern. The last two faults are logged into EE memory, with 8 bytes of information logged to aid location of the fault. These bytes are available for interrogation by a PC if required. The following faults have been implemented in the DishDrawer.

To clear any fault press the **Power** button. If the fault is still present then it cannot be cleared.

4.3 Diagnostic Modes

4.3.1 Temperature Display Mode

During a wash cycle, the current water temperature can be displayed on the LCD instead of the time remaining. To enter temperature display mode, start a wash cycle as normal. Initiate a keylock by pushing and holding the **Keylock** button for 4 seconds.

Once in keylock mode push and hold **Start/Pause** for 8 seconds to enter temperature display mode. The temperature is now displayed and the MIN symbol is switched off. Keylock mode can now be exited.

To cancel temperature display mode, either repeat the above procedure or enter power off mode by pressing **Power**. Temperature display mode is automatically cancelled at the end of a wash program (even in CC mode).

4.3.2 Rinse Aid / Tub-Open Beep Water Pressure Setup Mode

To enter this setup mode, hold the **Program** and **Eco** touch switches simultaneously for 5 seconds. Once the setup mode is entered a beep is emitted and the LCD is red with 'HP' displayed.

Push **Power** at any time to exit this setup mode.

4.3.3 Rinse Aid Setup

The current rinse aid setting is shown using orange LED's on the touch switch panel. The amount of rinse aid dispensed into a rinse cycle can be varied to suit the level of hardness of the local water supply. It is adjusted for 1 - 5 dispenser levels (1 = approx 1ml of rinse aid, 5 = approx. ounce equivalent of rinse aid).

Push **Programme** to advance the rinse aid setting. Once the desired setting is achieved, push **Power** to exit. The rinse aid index is stored in EE memory, so even with the power removed, the rinse aid level is retained.

4.3.4 Tub-Open Beep Setup

The beep sequence that occurs when the tub is opened can be turned on or off using the **Keylock** button. If the Smiley Face on the LCD is On then the beep sequence will occur when the tub is Opened. If the Smiley face is Off then no beeps will occur when the tub is Opened. Push **Power** to exit when the desired setting has been selected.

The Integrated Model will sound a single beep when turning this option off, while the actual beep sequence is sounded when turning this option on. The DishDrawer will default to 'beeps on' if the mains power is removed.

4.3.5. Water Pressure Set Up

The DishDrawer can be set to either High (Standard) or Low inlet water pressure. The LCD displays the current water pressure setting.

If “HP” is displayed then the setting is High Pressure.

If “LP” is displayed then the setting is Low Pressure. Low pressure is generally less than 50kPa or 7.25 PSI equivalent to that supplied by a ceiling tank.

Push the **Start/Pause** button to alternate between HP and LP.

Integrated: A high beep is sounded when changing the HP, and a low beep is sounded when changing to LP. Push **Power** to exit when the desired setting has been selected.

4.3.6 Dishwasher Diagnostics

Dishwasher Diagnostics can **only** be entered in Power Off mode, **ie.** When there is no display on the LCD or the badge LED's are off. Diagnostics is entered by holding the **Keylock** and **Start/Pause** buttons simultaneously for 6 seconds. Ensure that **Keylock** is pushed first to prevent the dishwasher from starting a wash, from a **Start/Pause** keypress.

There are currently four levels of diagnostics. To move to next level push **Power**. Once a mode has been entered, pushing **Power** will exit diagnostics completely (except Display & Show Off modes). If no mode is entered then the display will cycle through the four levels and exit after the last. On entering diagnostic mode the first level is Download Mode.

4.3.7 Display / Download Mode

In this mode all LED's (except Rinse program) and LCD segments (except keylock) are illuminated.

4.3.8 Optical LED Download / Fault Display

An optical data download is available here to download all EE data to a PC via the Rinse Program Red LED. Hold the reader pen over the Rinse Program LED and press **Start / Pause** to initiate the download. A short beep indicates the start and finish of download.

The last two faults are displayed on the LCD during the optical download, with the Current Fault code displayed first followed by the Previous Fault Code.

4.3.9 Clearing Fault Logs

To Clear the current Fault press the **Keylock** button until a beep is sounded. This action moves the Current Fault into the Previous Fault while clearing the Current Fault. To Clear the Previous Fault press **Keylock** once more until the beep is sounded.

Warning: Once a fault has been cleared it is permanently removed from Memory and cannot be recovered.

Press **Power** to advance to the next mode.

4.3.10 Show Off Mode

This mode initiates a shop show off display and operation demonstration. The LCD display is Red backlight 'Ad'. The touch switch LED's are - Grn Grn __ Grn Grn.

Press **Power** to move onto the next mode.

Press **Start/Pause** to initiate show off mode:

A short series of tones indicates that Show Off mode has been entered. The Show Off display cycles through every LED, & LCD segment. If any front panel key is pressed the dishwasher will re-initiate a series of short tones.

Once Show Off mode has been initiated, the mains power must be removed to exit out of Show Off mode.

4.3.11 Hardware Output Diagnostic Test Mode

This mode tests all the hardware outputs and inputs. The LCD display is Red backlight and 'HO'.

Press **Power** to skip hardware diagnostics and advance to the next mode.

Press **Start/Pause** to enter hardware diagnostics.

Once hardware diagnostics has been entered the current hardware output being tested is indicated in green on the touch switch panel, using binary encoding, and also on the LCD as shown below.

Any combination of outputs can be switched on or off. Load sensing is enabled when the motor is running.

Press **Start/Pause** to advance to next hardware output.

Press **Keylock** to turn the currently displayed output On or Off. If the currently displayed output has a green backlight then that output has been switched on, and if the backlight is red then that output is off.

Press **Power** to Exit at any time (All outputs will be switched off on exit).

The LCD display and touch switch panel green LED's are illuminated to correspond to a particular hardware device. The following table details the display order of the test.

LCD	Heavy	Norm	Fast	Deli	Hardware Output
EU	Off	Off	Off	<u>On</u>	Exhaust Valve
FU	Off	Off	<u>On</u>	Off	Fill Water Valve
dd	Off	Off	<u>On</u>	<u>On</u>	Detergent Diverter Valve
LS	Off	<u>On</u>	Off	Off	Lid Seal Pump
rd	Off	<u>On</u>	Off	<u>On</u>	Rinse Aid Dispenser (dispenses current setting)
P1	Off	<u>On</u>	<u>On</u>	Off	Motor Wash direction (2300-2850 rpm)
P2	Off	<u>On</u>	<u>On</u>	<u>On</u>	Motor Drain direction (4200 rpm)
dF	<u>On</u>	Off	Off	Off	DC drying fan (On 100% duty)
Er	<u>On</u>	Off	Off	<u>On</u>	Element Relay
'temp'	<u>On</u>	Off	<u>On</u>	Off	Displays current water temperature.

WARNING: As there is no protection in this mode it is possible to turn the element on with no water in the tub. It is advisable to avoid turning on the element without water in the tub.
NB: No Fault codes will come up while in diagnostics mode.

Tab Open Microswitch Test: At any time during HO test mode the **Rinse** red LED indicates the tub position. On = Open, Off = Closed.

Note: There maybe a short delay (up to 0.5sec) from when the tub has changed state to the position that is indicated on the LED. This is due the communication delays between the two micro-controllers.

4.3.12 Continuous Cycle Life Test Mode

In this mode the dishwasher can be run continuously in any wash cycle. Once the cycle has finished, the dishwasher automatically restarts the same wash cycle.

The LCD is Red backlight and display CC. The touchswitch panel is - Red Red __ Red Red.

To exit diagnostic mode push **Power**.

To initiate a continuous cycle press **Start/Pause**. The dishwasher will enter standby mode. Choose the required cycle and operate the dishwasher as normal. Continuous cycling can be canceled at any time by pushing the **Power** button, or removing the mains power. Continuous cycling is indicated by the backlight alternating between green and orange.

In continuous cycle a delay occurs when a cycle has finished before the next cycle starts. This delay is currently 1 min. During this time the LCD displays a finish cycle display, and the backlight alternates between RED and OFF.

Cycle Count Retrieval

To display the cycle count on the LCD screen, Pause the dishwasher while running a Continuous Cycle. The two bytes of the cycle count will be displayed alternately, in synchronization with the changing backlight.

The Low byte is displayed when the backlight is Green.

The High byte is displayed when the backlight is Orange.

To calculate the Total dishwasher cycle count use the formula below.....

$$\text{Cycle_Count} = ((200 \times \text{High_byte}) + \text{Low_byte}).$$

Eg. $\text{Low_byte} = 156$
 $\text{High_byte} = 21$
 $\text{Cycle_Count} = ((200 \times 21) + 156) = 4,356.$

4.4 Diagnostics Quick Reference Flow Chart

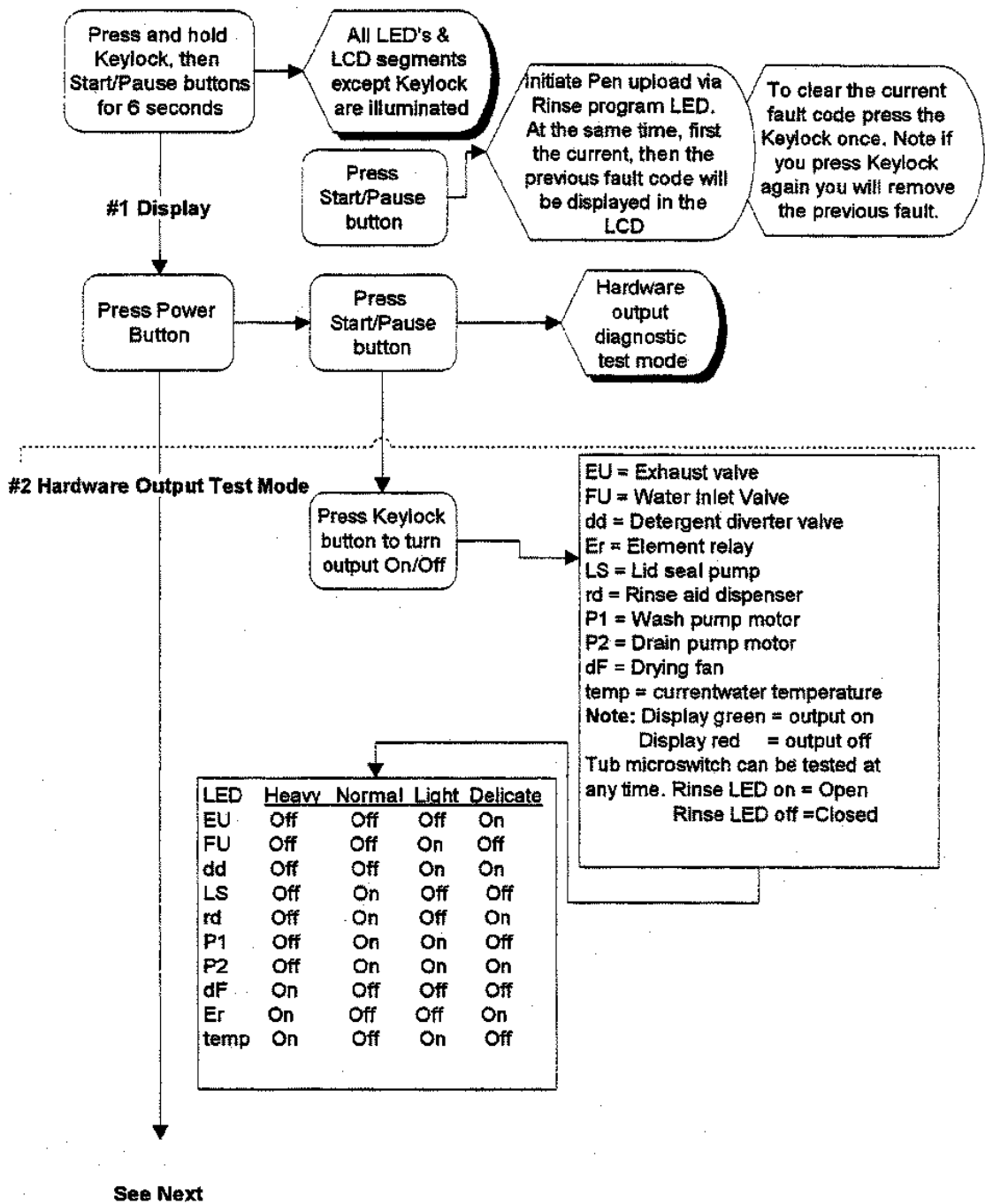

4.4 Diagnostics Quick Reference Flow Chart cont'd

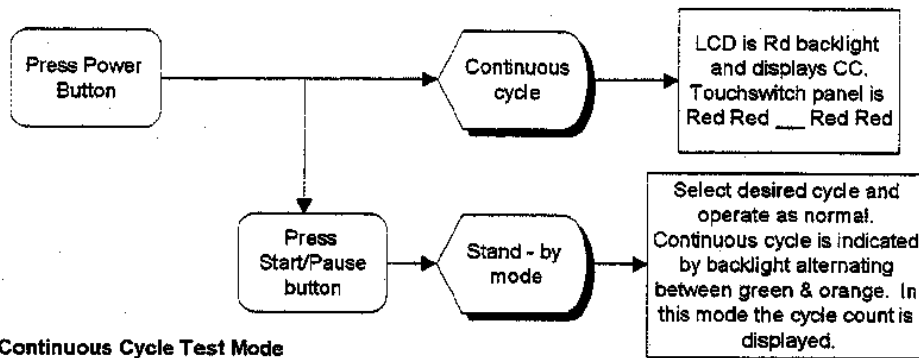

Once a mode has been entered, press Power to exit diagnostics except Display and Show Off modes) which require the plug to be removed from the power socket.

Rinse Aid Adjustments/Tub Open Beep/Water Pressure Setup

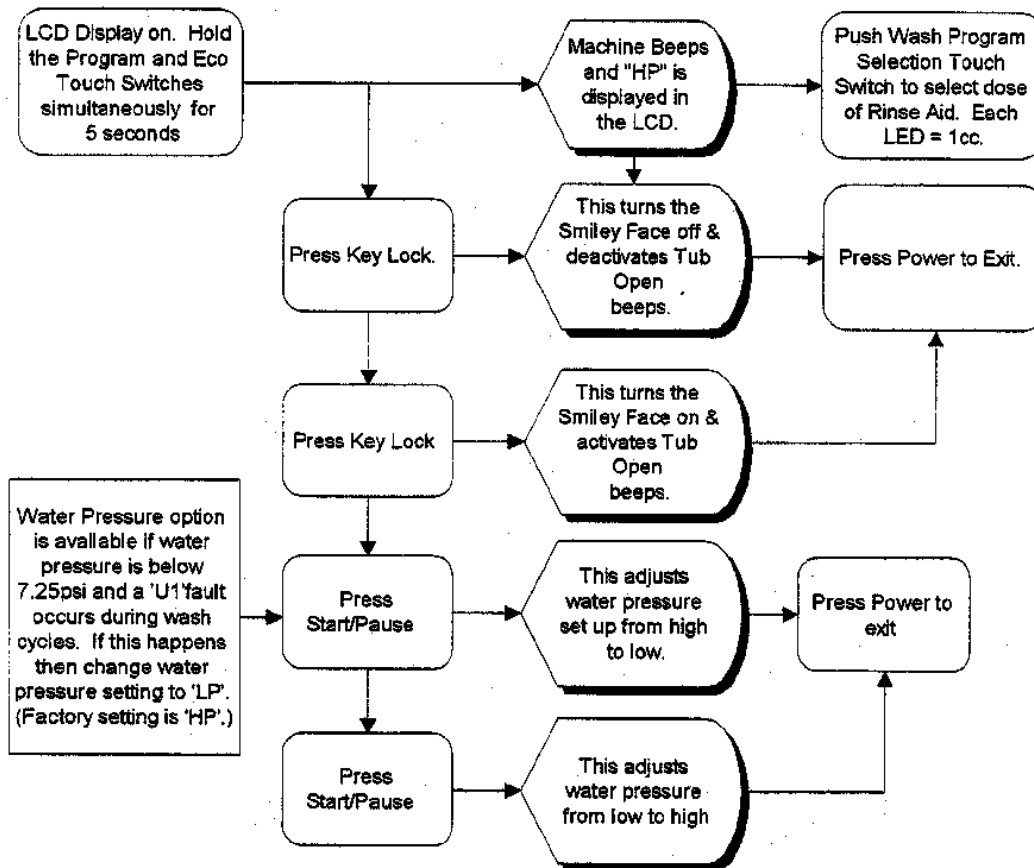

4.5 Fault Codes

Fault Code	LED Display	Fault	Possible Causes
F1	----#	The flood switch has been activated.	<ul style="list-style-type: none"> • A leak has occurred in the base of the dishwasher. • The fill valve has failed open. • The flood switch is faulty. • Excessive water has been added to a wash sub cycle, indicating leaking seal or siphoning.
F2	---#-	The motor is not rotating.	<ul style="list-style-type: none"> • Foreign matter has jammed the motor. • The motor drive electronics or power supply have failed. • The rotor is faulty or missing. • The hall sensor is faulty or missing.
F3	---##	The water temperature is greater than 176°F.	<ul style="list-style-type: none"> • The element has failed on. • The temperature sensor has failed. • The electronics ADC has failed. • The incoming water temperature is greater than 176°F.
F4	--#--	No temperature increase has been recorded when the element is on.	<ul style="list-style-type: none"> • The element is not connected. • The element has gone open circuit. • Temperature sensor or electronics ADC has failed.
F6	--##-	Communications Baud rate error.	<ul style="list-style-type: none"> • The motor control micro has communications set at an incorrect baud rate. • Communication echo bytes are consistently incorrect (perhaps due to noise). • External master device has incorrect baud rate.
F7	--###	Communications Time-Out error.	<ul style="list-style-type: none"> • The motor control micro has crashed and is not responding to communications requests. • The hardware communications link from console to motor micro has broken. • An external device is holding the communications line low.
F8	-#---	RAM fault.	<ul style="list-style-type: none"> • The electronic controller has RAM fault.

Fault Code	LED Display	Fault	Possible Causes
U1	#--#	Fill fault. The motor has not primed after a given time.	<ul style="list-style-type: none"> • The water supply is not turned on. • The machine is siphoning. • The sprayarm is not in place. • Excessive foaming. • The fill valve has failed closed. • The machine is set to 'HP' on a low pressure water supply.
U2	#--#-	Tub open fault.	<ul style="list-style-type: none"> • The drawer has been forced open during a wash cycle. • The drawer microswitch has failed. • The exhaust valve has failed open circuit.
U3	#--##	Time to fill was too short, indicating water was still in the tub.	<ul style="list-style-type: none"> • Drain pump is blocked. • Drain hose is blocked. • Sprayarm or rotor not turning freely. • Motor electronics have failed. • Machine set to 'LP' on a high pressure water supply.

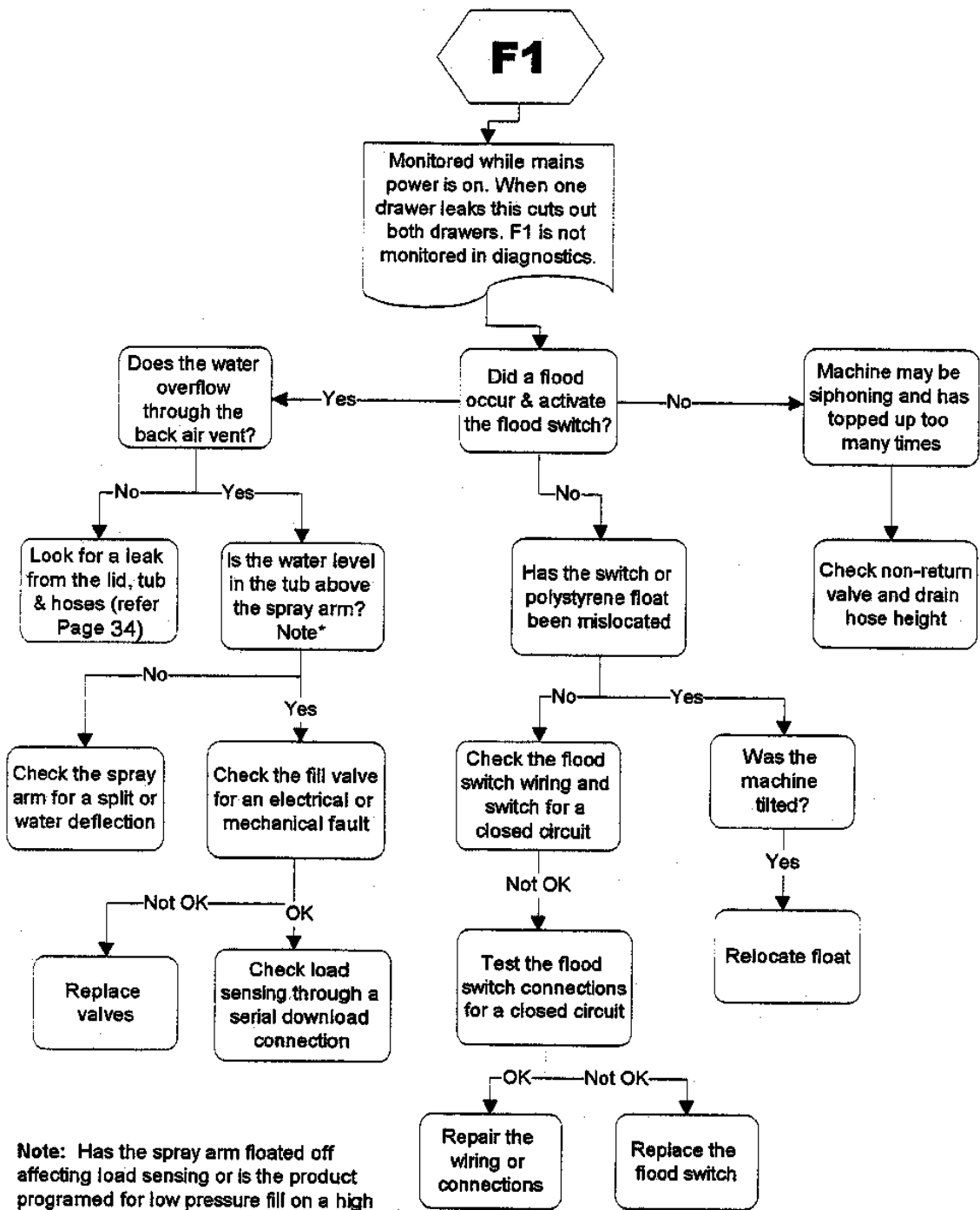

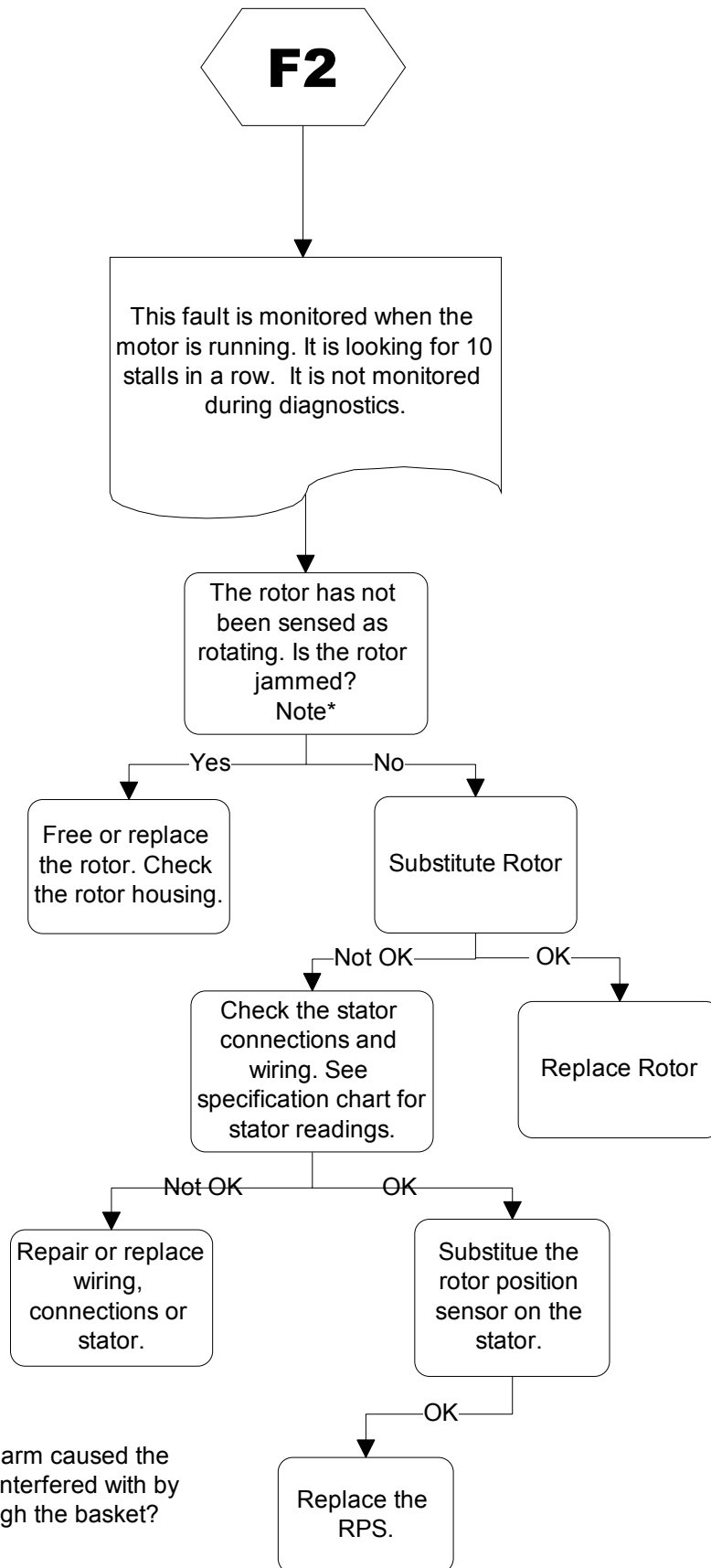

*Note: Has the spray arm caused the rotor to jam by being interfered with by an object falling through the basket?

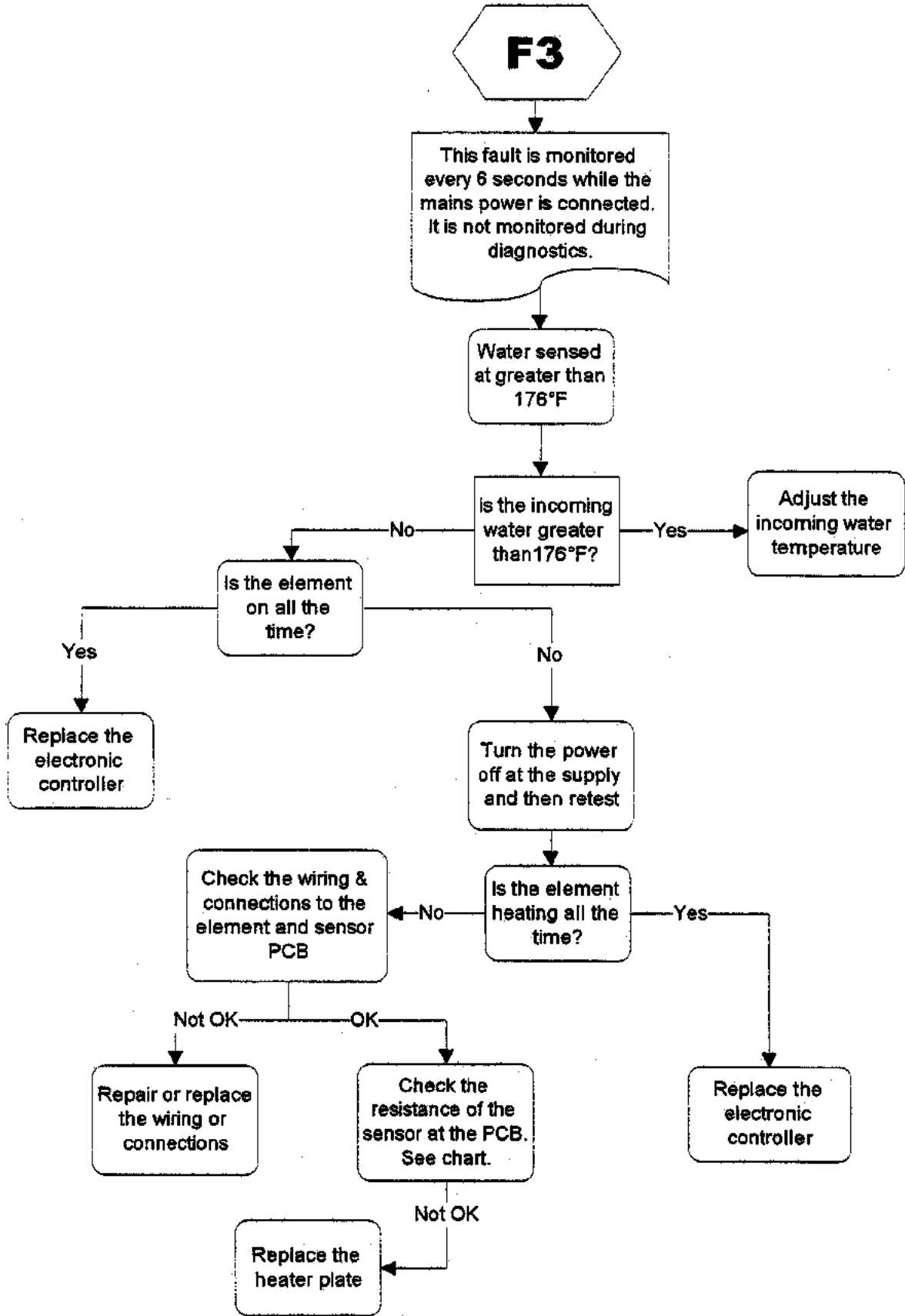

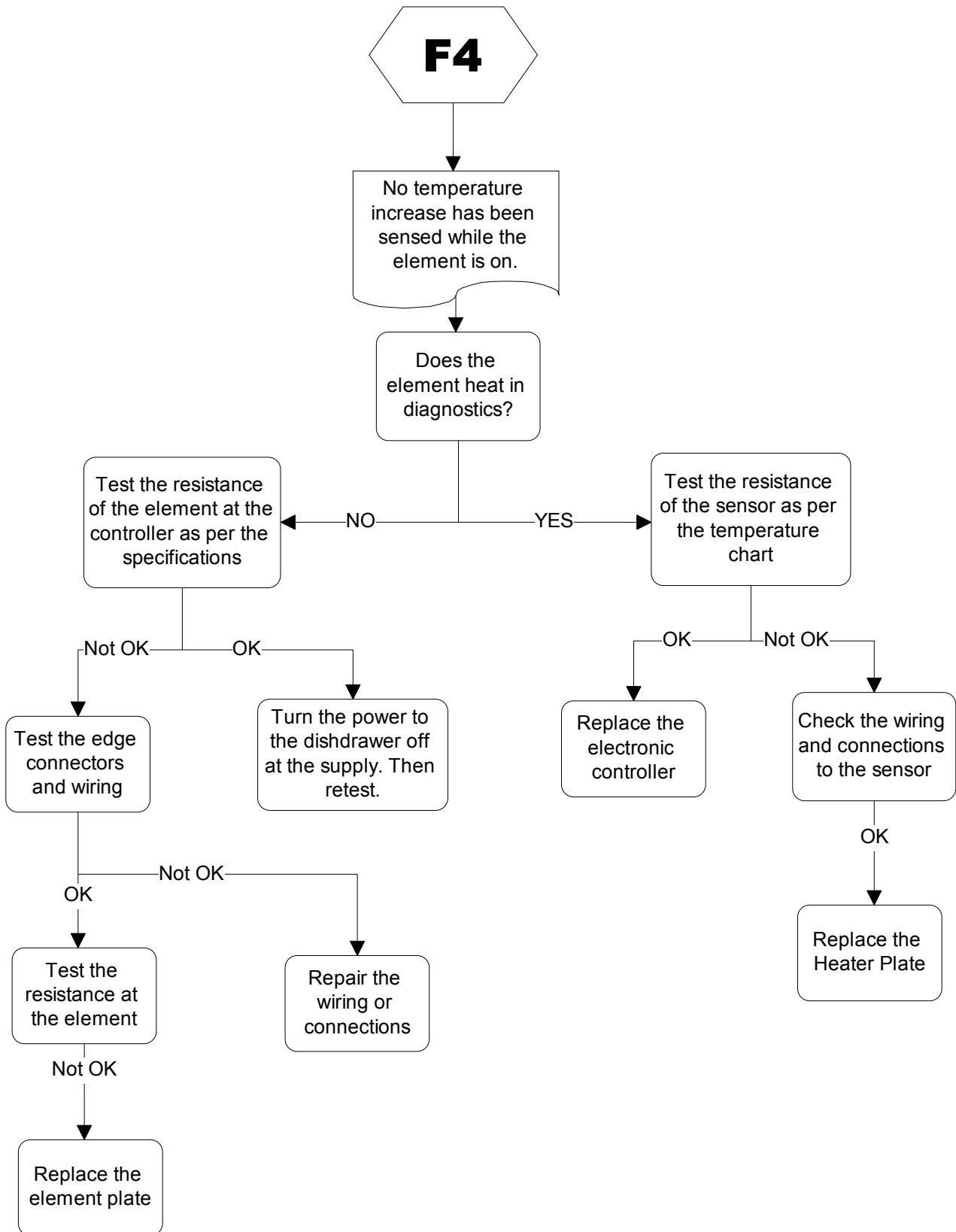

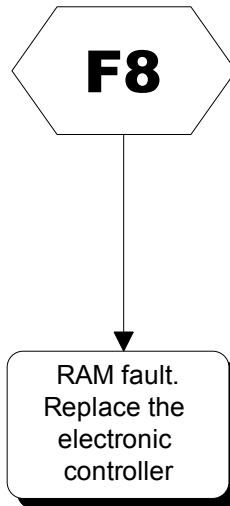
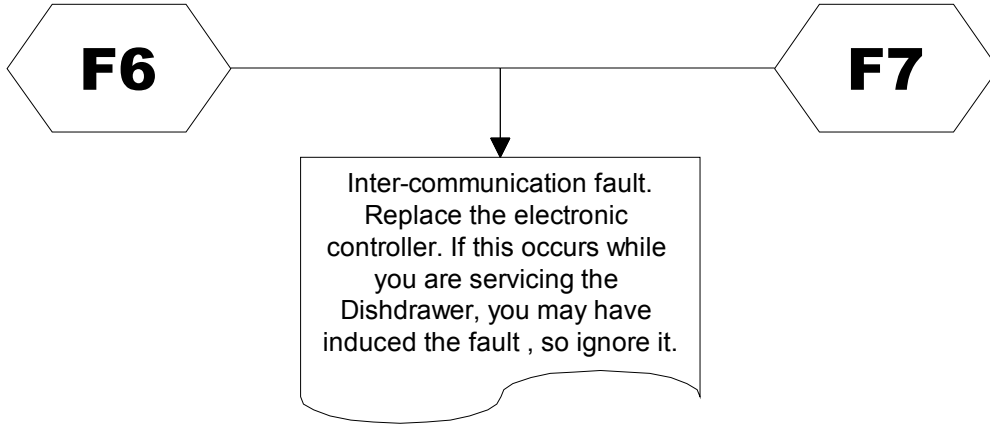

U1

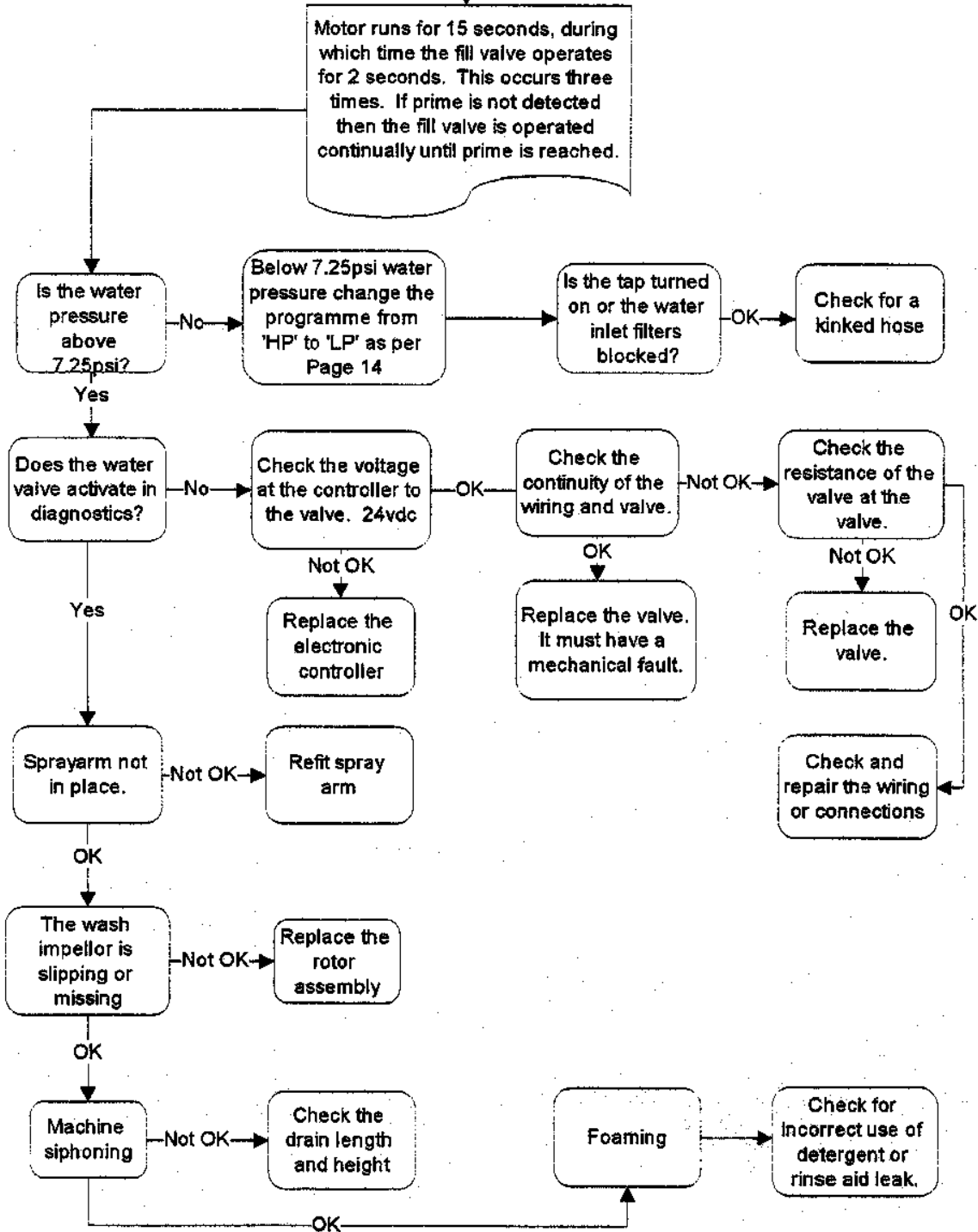

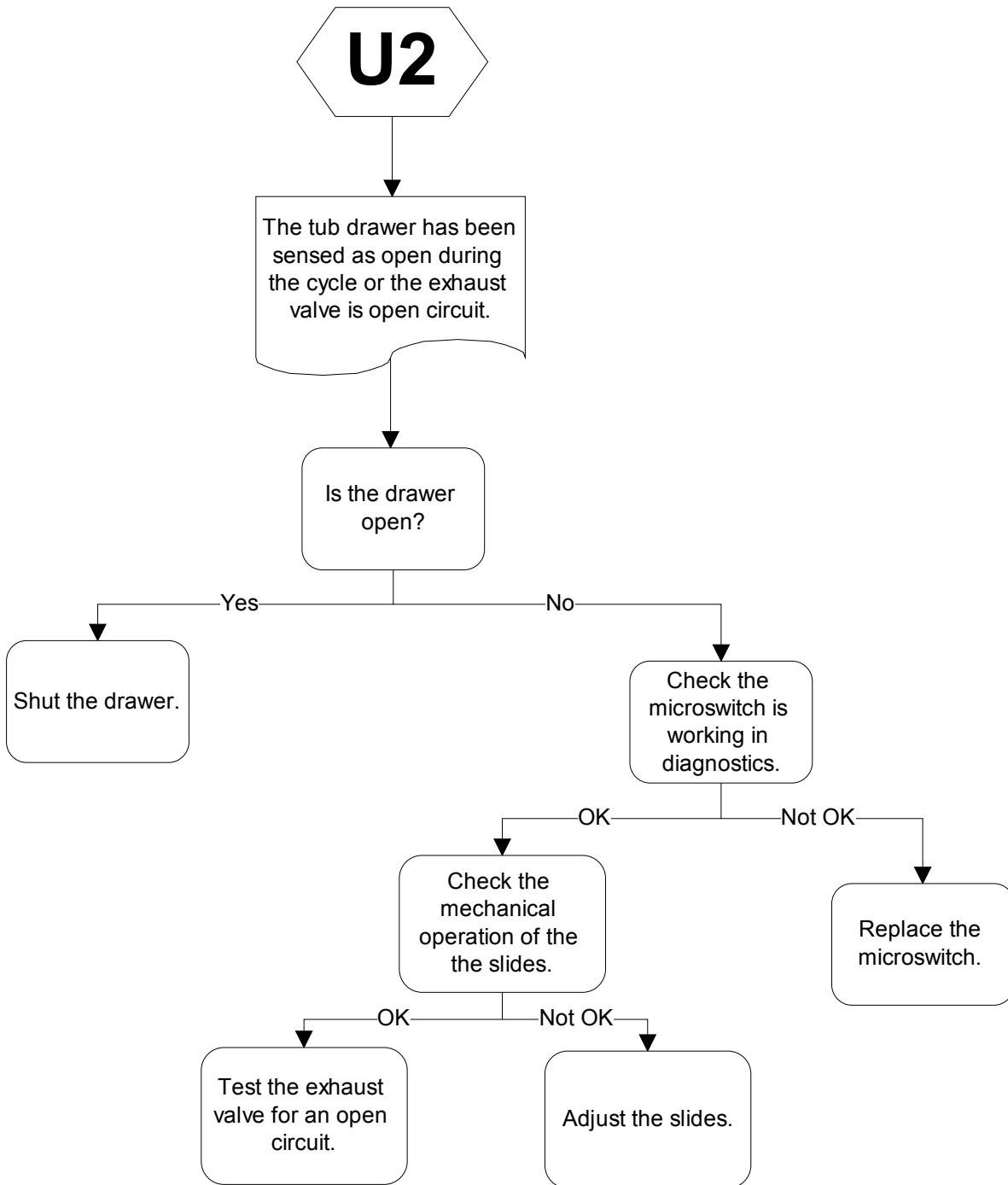

Note: Tub home microswitch is located on the rear of the left slide runner and is connected in series with the exhaust valve.

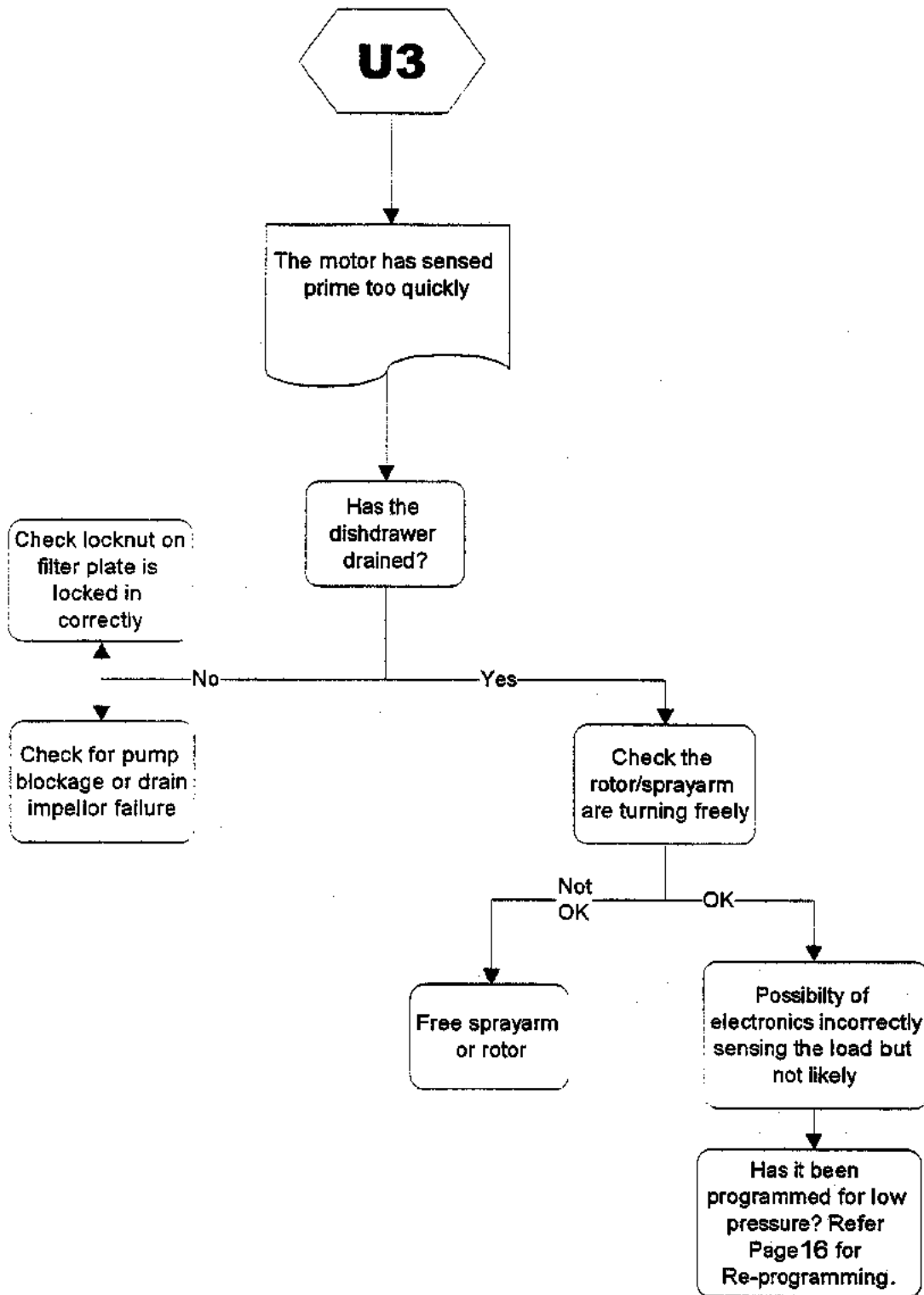

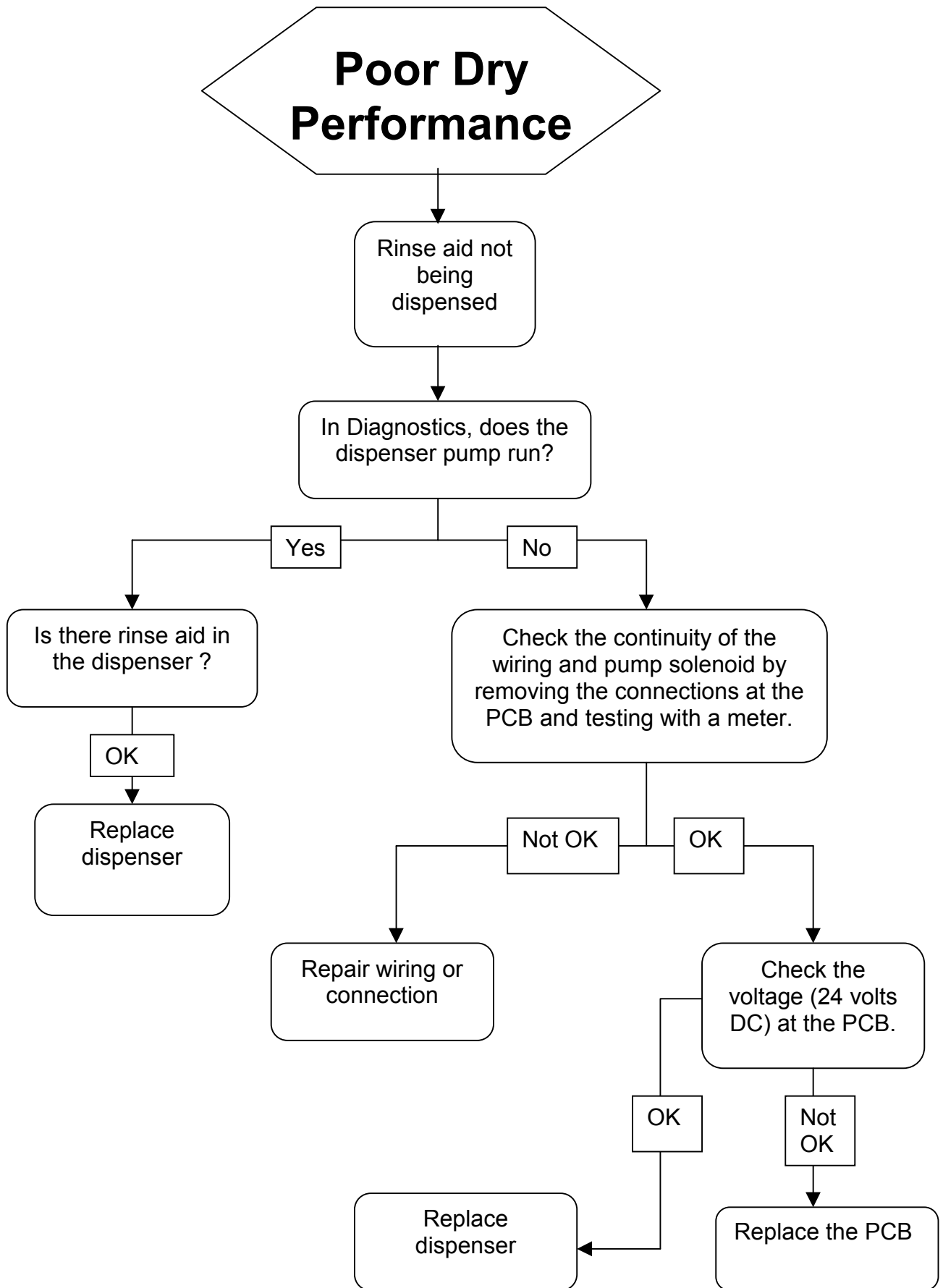

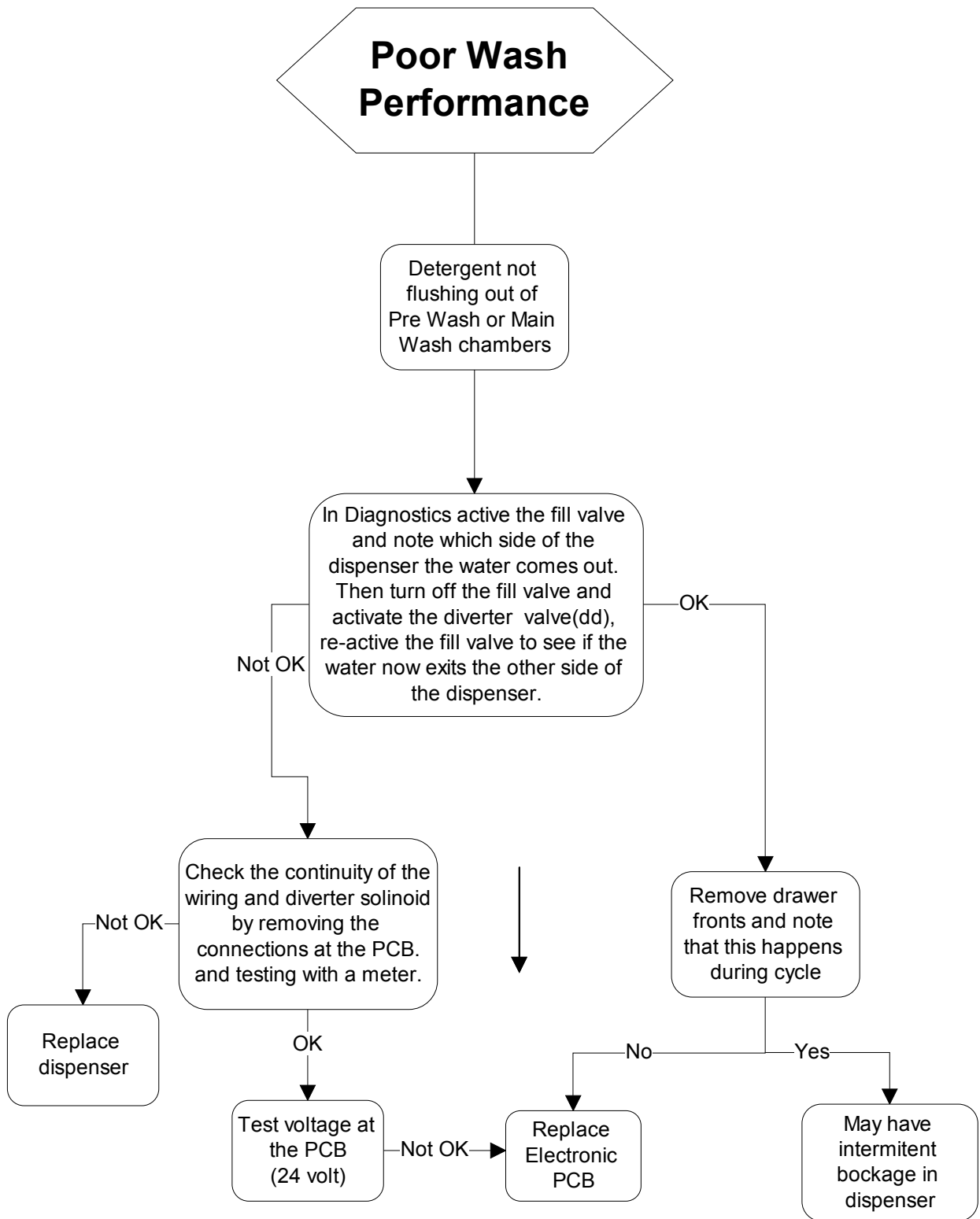

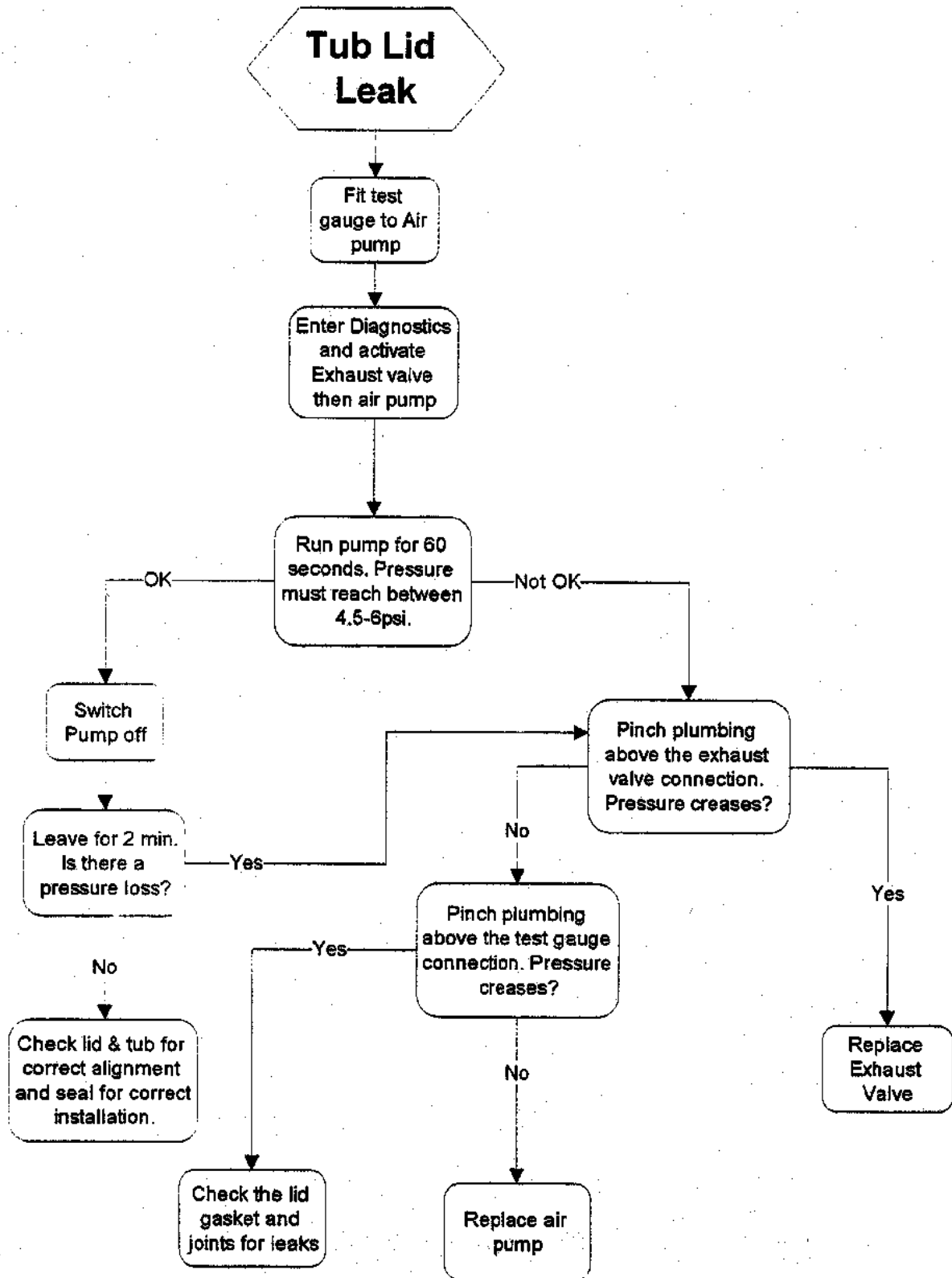

5.0 WIRING DIAGRAM

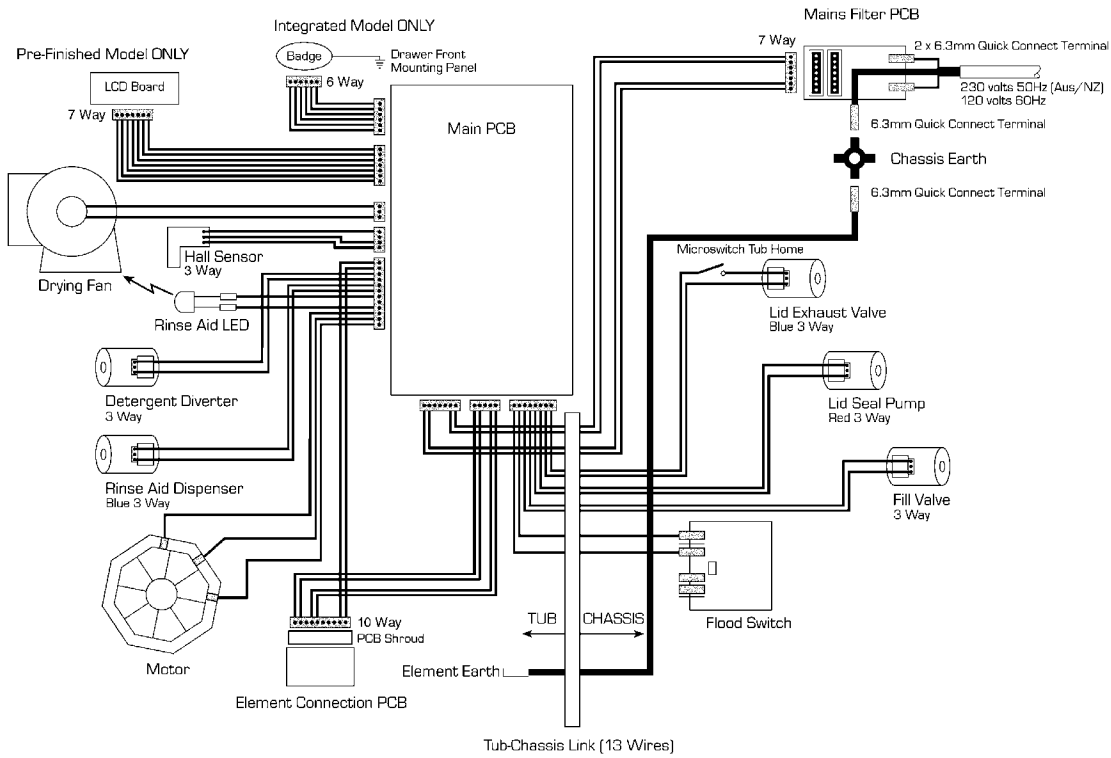

6.0 SERVICE PROCEDURES

6.1. Drawer Front Removal



- 6.1.1 Slide open drawer.
- 6.1.2 Locate draw pin on either side of the tub.
- 6.1.3 Using a sharp pair of long nose pliers or slip jaw pliers grasp the center dividing web of the pin and pull away from the tub to remove the pin. Support the drawer front with your hand while doing this.
Note: The pin web is vertical.
- 6.1.4 With both pins removed the bottom of the drawer front can now be eased down and forward so as to clear the microswitch lever.
- 6.1.5 Now carefully pull the drawer front down to allow it to come free from the top locating slots.
- 6.1.6 This allows the drawer front to come away with the handle insert and insulation.
- 6.1.7 Refit in reverse manner insuring the drawer slides are right forward and the pin secures through the hook on the front end of the slide.

Note: When reinserting the pins make sure the dividing web is vertical.

6.2. Handle and LCD Display Removal

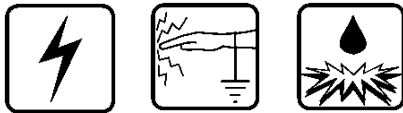

- 6.2.1 Remove the drawer front as per instructions in 6.1.
- 6.2.2 The handle clips under two location inserts either side of the tub. Pull forward on the handle tabs and this will release them from the location inserts.
- 6.2.3 Disconnect the seven wire harness from the electronic controller to the LCD or Badge.
- 6.2.4 The handle may now be lifted clear.
The LCD display is held in place by a spring tab on one end. Using a small blade screwdriver slip it down the end of the LCD with the single tab. This will release the LCD.
- 6.2.6 The wiring harness can now be unplugged from the LCD.
- 6.2.7 Push pads can now be removed. The LCD display holds these in place.
- 6.2.8 Refit in reverse manner.

6.3 Drying Fan Removal

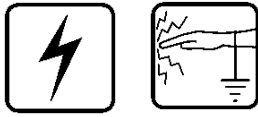

- 6.3.1 Remove the drawer front as per instructions in 6.1.
- 6.3.2 Slide forward the drying fan duct and remove.
- 6.3.2 Disconnect the two wire harness from the electronic controller
- 6.3.3 Release the three securing tabs that hold the drying fan in place while applying forward pressure on the drying fan.
- 6.3.4 The drying fan will now come free.
- 6.3.5 Refit in reverse manner.

6.4 Detergent Dispenser



- 6.4.1 Remove the drawer front and handle as per instructions in 6.1 & 6.2
- 6.4.2 Disconnect the two wiring loom connections off the dispenser coils. Note: Push back locking tabs to allow connectors to release.
- 6.4.3 Unclip the retainer flap at the bottom center of the dispenser and slide out the rinse aid level LED.
- 6.4.4 Unclip the fill hose on the dispenser
- 6.4.5 While holding the dispenser unscrew the six T10 Torx drive screws securing the brackets around the dispenser.
- 6.4.6 The dispenser can now be removed from inside the tub.
- 6.4.7 The coils can be replaced as a spare part by sliding them off the armature.
- 6.4.8 To open up the dispenser door fully, first open the door using the release catch then squeeze the top sides of the door. This will release the door to the fully open position. This can be done with the dispenser in place.
- 6.4.9 Refit in reverse manner ensuring the dispenser gasket is located correctly.

6.5 Electronic Controller

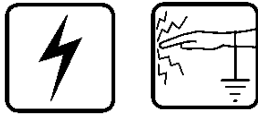

- 6.5.1 Remove the drawer front and handle as per instructions in 6.1 & 6.2.
- 6.5.2 Placing a finger either side of the top sides of the controller, pull it forward until the controller clears the top edge of the tub.
- 6.5.3 Disconnect the wiring connectors down the left side of the controller.
- 6.5.4 The controller can now be tipped down to 90° from it's original position. This will allow the disconnection off the lower wiring connectors and the two and three wire looms from their wire duct.
- 6.5.6 The controller can now be lifted clear.
- 6.5.7 Refit in reverse manner.

6.6 Top Kick Strip Removal



- 6.6.1 Pull out the lower drawer.
- 6.6.2 Place both hands under the top kick strip.
- 6.6.3 Pull the bottom of the top kickstrip forward quickly.
- 6.6.4 Tipping it right up will allow the top locating tabs to drop out of the tub inserts.
- 6.6.5 Refit in reverse manner ensuring it is clipped into place.

6.7 Lower Kick Strip Removal



- 6.7.1 Remove the top kick strip as per instructions in 6.6.
- 6.7.2 Insert a flat blade screwdriver into the two inserts in the trim above the lower kick strip and twist.
- 6.7.3 This will unclip the lower kick strip from the chassis.
- 6.7.4 Refit by locating the lower kick strip pins into the chassis clips and foot retainer clips.
- 6.7.5 Push on the face of the lower kick strip to locate home the lower kickstrip pins.

6.8 Wiring Cover Removal

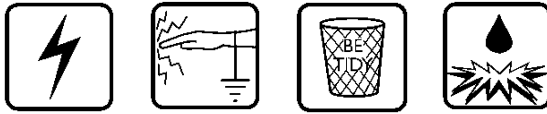

- 6.8.1 Remove the drawer front as per instructions in 6.1.
- 6.8.2 Unclip the front two legs of the wiring cover from under the electronic controller and the front left hand side of the tub.
- 6.8.3 Release the three clips on the underside of the tub, which retain the wiring cover.
- 6.8.4 The wiring cover may now be moved forward to release it from the link assembly at the rear.
- 6.8.5 To reassemble first ensure that the wiring harnesses, drain hose and fill hose are clipped into their correct position.
- 6.8.6 Then refit in reverse manner.

6.9 Filter Plate Removal

- 6.9.1 Remove the lower racks from the tub.
- 6.9.2 Remove the drain filter assembly.
- 6.9.3 Rotate the filter plate locknut anti-clockwise to release the filter plate from the rotor assembly.
- 6.9.4 Lift the filter plate clear.
- 6.9.5 Refit in reverse manner.

6.10 Rotor Assembly Removal

- 6.10.1 Remove filter plate as per instructions 6.9.
- 6.10.2 Rotate the rotor locking ring anti clockwise to release it from the motor assembly.
- 6.10.3 This assembly is not serviceable.
- 6.10.4 Refit in reverse manner.

6.11 Tub Removal

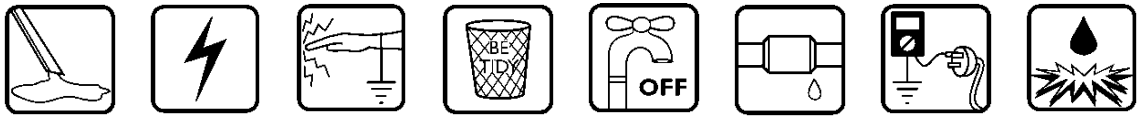

- 6.11.1 Remove the drawer front as per instructions in 6.1.
- 6.11.2 Remove the wiring cover as per instructions in 6.8.
- 6.11.3 Disconnect the fill hose from the dispenser (water may drip)
- 6.11.4 Disconnect the mains harness and chassis harness connectors from the electronic controller.
- 6.11.5 Unclip the drain hose cuff from the motor assembly.
- 6.11.6 From the under side of the tub now unclip the drain hose, fill hose and the wiring looms which go to the link assembly. Disconnect the earth wire off the element plate.
- 6.11.7 The link assembly can now be unhooked from the rear of the tub by pressing the spigots back through the tub connection point.
- 6.11.8 The tub may now be lifted at the front and slipped forward off the slide runners.
- 6.11.9 Refit in reverse manner.

6.12 Locking Ring, Element Plate and Motor Assembly Removal

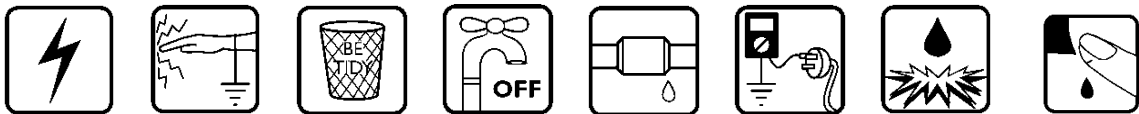

- 6.12.1 Remove the drawer front, tub, filter plate and rotor assembly as per instructions in 6.1, 6.9, 6.10 & 6.11.
- 6.12.2 Disconnect the wiring connectors off the heater plate and motor (mark motor wire location). To release the motor connections push a fine blade screwdriver down alongside the wiring connection to release the locking barb on the terminal.
- 6.12.3 Disconnect the rotor position sensor from the motor housing.
- 6.12.4 While lifting the tab on the locking ring, rotate the ring anticlockwise until it comes free of tub tabs.
- 6.12.5 This also releases the motor housing from the locking ring.
- 6.12.6 Holding the pump housing on the motor assembly lift the locking ring, heating plate and motor clear of the tub.
- 6.12.7 The suction pipe of the drain molding will slide out of the tub drain area.
- 6.12.8 You may now lift the locking ring clear of the motor assembly. This will allow the heater plate and motor assembly to come apart
- 6.12.9 Be careful of the two 'O' rings which seal between the motor assembly and heater plate and the heater plate and tub, these and the tub sealing area must be clean and put in the correct place before reassembly takes place.
- 6.12.10 Check both the drain cuff 'O' ring and suction pipe 'O' ring for deformation and damage. Lubricate and if necessary replace 'O' rings before reassembly.
- 6.12.11 Reassemble in reverse manner ensuring all locking ring tabs are engaged.

6.13 Lid Assembly Removal

- 6.13.1 Remove tub assembly as per instructions in 6.11
- 6.13.2 Disconnect the lid plumbing off the exhaust valve and air pump above the 'Y' joint.
- 6.13.3 Release two locking tabs securing the front of the lid to the chassis.
- 6.13.4 To do this, push back the tab in the center of the rectangular slot at the front of the lid molding, using a blade screwdriver, then apply downward pressure to the lid while holding the tab back.
- 6.13.5 The lid will now drop into the chassis opening and this will allow it to be slid forward out of the chassis area.
- 6.13.6 Refit in reverse manner being careful not to damage the seal when fitting the lid in through the chassis. Ensure the location tab at the right rear of the lid locates to the right of the rear chassis support.

Note: The bottom lid has a strengthening bar at the rear.

6.14 Lid Seal Replacement

- 6.14.1 Remove Lid assembly as per instructions 6.13.
- 6.14.2 Remove the seal by grasping hold of it in the middle and easing it away from the lid. This will release the fir tree part of the gasket from the retaining slot.
- 6.14.3 Ease the gasket away from the air plumbing connector joint at the rear of the lid.
- 6.14.4 Fit the new up to the shoulder on the plumbing connection. Slide both ends of the lid seal into place ensuring they rest against the stops.
- 6.14.5 Lay the gasket in the approximate position around the lid.
- 6.14.6 Press the gasket into position at each corner. The fir tree section pushes into the lid slot.
- 6.14.7 Now the rest of the gasket can be pushed in around the lid section.
Note: This is a push in seal and does not require a sealant.
- 6.14.8 Testing the gasket with an extension piece of air plumbing, air gauge and air supply before fitting would be advisable. Pump the gasket up to 6psi and then pinch off the supply. The pressure should not drop below 4.5psi over a 60-second period.
- 6.14.9 Refit lid as per instructions in 6.13.6.

6.15 Slide Runner Replacement

- 6.15.1 Remove the Tub as per instructions 6.11
- 6.15.2 Bottom slide runners only. Remove the two large Philips head screws securing the slide runner at the front. The backing plate that the screws locate into may come loose. This does not matter. It can be realigned on reassembly.
- 6.15.3 Tap the slide runner from underneath at the front. This will knock the slide runner up and free from its location in the chassis.
Note: On the bottom lefthand slide runner the water valve mounting bracket will come away as well. This will mean the water and electrical connections will have to be disconnected first. On the top LHS slide runner the tub home microswitch will have to be disconnected.
- 6.15.4 The slide runner may now be pulled forward to release it from its location in the rear of the chassis.
- 6.15.5 Refit in reverse manner.

6.16 Front Trim Replacement



- 6.16.1 The trim has to be removed by breaking the retaining clips.
- 6.16.2 This can be done by slipping a blade screwdriver between the trim and the chassis and twisting the blade to snap the clips. Protect the cabinet from chipping and remove the broken clips.
- 6.16.3 Line up the clips on the replacement trim with the holes in the chassis and push home.

6.17 Sound Gasket Replacement

- 6.17.1 Remove the sound gasket by grasping it in the middle with your fingers and pulling it out of the trim.
- 6.17.2 To refit, feed the ends of the sound gasket into the ends of the trim slot.
- 6.17.3 Push the middle section of the sound gasket into the slot then work the rest in.
- 6.17.4 Roll the sound gasket with a coin to get it even.

6.18 Link Assembly Removal

- 6.18.1 Remove tub as in instructions 6.11.
- 6.18.2 Release clips on side of link assembly to allow the lid of the assembly to hinge open.
- 6.18.3 Using a blade screwdriver to wedge out the spigots in the hinge point of the bracket connecting to the rear of the dishwasher.
- 6.18.4 With both assembly lid open and the hinge point free the assembly may be released from the drain hose, fill hose and wiring harnesses (mark on the harnesses and hoses the location of these to the lid so that when reassembling they are put back in the same location).
- 6.18.4 To replace the link assembly bracket, release the wire and hose retaining clip to free these items, then slide the bracket up and out of rear panel.
- 6.18.5 Refit in reverse manner.

6.19 Air Pump Removal

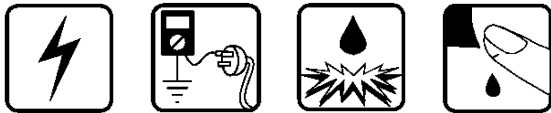

Note: This component maybe serviced by two Methods.

- 6.19.1 Method 1: Remove appropriate tub assembly as per instructions in 6.11.
- 6.19.2 Method 2: Remove lower kick strip as per instructions in 6.7
- 6.19.3 Remove the clip pegs from the slide retainers.
- 6.19.4 Slide the DishDrawer from the cavity to allow servicing from the rear.
- 6.19.5 Remove the screw securing the rear service panel.
- 6.19.6 Fit a screwdriver through the hole in the rear service panel and lift or tap the shaft of the screwdriver up so to disengage the panel from its retainers.
- 6.19.7 The service procedures from now on are the same for both methods.
- 6.19.8 Disconnect the air plumbing from the air pump.
- 6.19.9 The air pump can now be released from the rubber mount (if sliding the rubber mount off the exhaust valve be careful not to lose the steel core which will fall out of the exhaust valve. The exhaust valve core is fitted with the rubber end upper most).
- 6.19.10 Disconnect the wiring connector from the coil.
- 6.19.11 Refit in reverse manner. Ensure the pump hangers are correctly located.

6.20 Exhaust Valve Removal

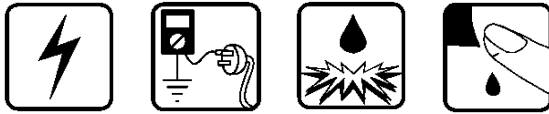

Note: This component maybe serviced by two Methods.

- 6.20.1 Method 1: Remove tub assembly as per instructions in 6.11.
- 6.20.2 Method 2: Remove lower kick strip as per instructions in 6.7.
- 6.20.3 Remove the clip pegs from the slide retainers.
- 6.20.4 Slide the DishDrawer from the cavity to allow servicing from the rear.
- 6.20.5 Remove the screw securing the rear service panel.
- 6.20.6 Fit a screwdriver through the hole in the rear service panel and lift or tap the shaft of the screwdriver up so to disengage the panel from its retainers.
- 6.20.7 The service procedures from now on are the same for both directions.
- 6.20.8 Lift the exhaust valve up to disengage the mounting from the chassis.
- 6.20.9 Disconnect the air plumbing from the exhaust valve.
- 6.20.10 Remove the exhaust valve from the rubber mount (be careful not to lose the steel core, which will fall out of the exhaust valve. The exhaust valve core is fitted with the rubber end upper most).
- 6.20.11 Disconnect the wiring connection from the exhaust valve.
- 6.20.12 Refit in reverse manner. Ensure the pump hangers are correctly located.

6.21 Water Valve Removal

- 6.21.1 Remove the lower tub as per instructions in 6.11.
- 6.21.2 The water valve is located at the rear on the lefthand side.
- 6.21.3 Disconnect the wiring connections to both solenoids. Release the locking tabs for the connectors with a blade screwdriver while doing this.
- 6.21.4 Disconnect the inlet hose connection.
- 6.21.5 The water valve may now be slid forward off the mounting bracket.
- 6.21.6 Disconnect the two fill hoses off the valve noting which hose goes to the top and tub and which goes to the bottom tub.
- 6.21.7 Refit in reverse manner.

6.22 Flood Switch Removal

- 6.22.1 Remove the lower tub as per instructions in 6.11
- 6.22.2 The flood switch is located on the base of the chassis.
- 6.22.3 Remove the wiring connections to the switch noting each connection location.
- 6.22.4 The switch is released from the chassis by squeezing together the pins on the legs of the switch with a fine blade screwdriver.
- 6.22.5 Refit in reverse manner.

6.23 EMI Filter Removal

- 6.23.1 Remove the lower tub as per instructions in 6.11.
- 6.23.2 The EMI filter is located at the rear left hand side of the chassis base.
- 6.23.3 Remove the screw in the rear access panel of the chassis.
- 6.23.4 Raise the insulating cover to expose the EMI filter.
- 6.23.5 The EMI filter can now be replaced or serviced.
- 6.23.6 Refit in reverse manner.

6.24 Tub Microswitch Removal

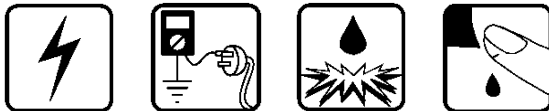

Note: Located on the rear of the left slide runner and connected in series with the exhaust valve, this component can be serviced by two methods.

- 6.24.1 Method 1:
Remove the slide runner as per instructions in 6.15.
- 6.24.2 Method 2:
Remove lower kickstrip as per instructions in 6.7.
- 6.24.3 Remove the clip pegs from the slide runners.
- 6.24.4 Slide the DishDrawer from the cavity to allow servicing from the rear.
- 6.24.5 Remove the screw securing the rear service panel.
- 6.24.6 Fit a screwdriver through the hole in the rear service panel and lift or tap the shaft of the screwdriver up so as to disengage the panel from its retainers.
- 6.24.7 The service procedures from now on are the same for both methods.
- 6.24.8 Disconnect the wiring to the microswitch.
- 6.24.9 Release the microswitch from the retaining clips on latch retaining mechanism on the drawer slide.
- 6.24.10 Refit in reverse manner.