



# TECHNICAL SERVICE GUIDE

## "Z" MODEL DISHWASHERS



### MODEL SERIES:

Profile Performance™ Series

GSD4900Z

GSD4600Z

Profile™ Series

GSD4300Z

GSD4000Z

GE Series

GSD3000Z

GSD2000Z

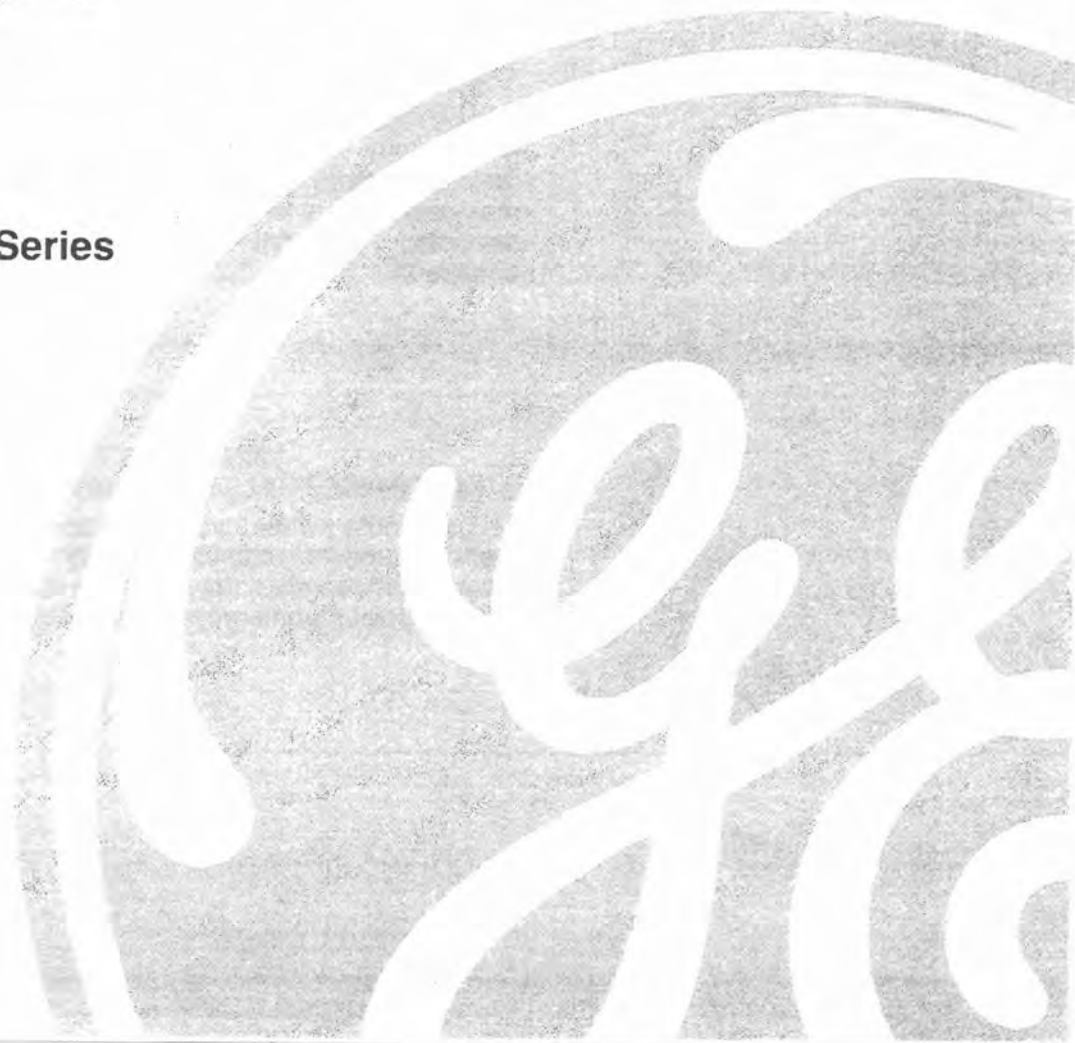



### **IMPORTANT SAFETY NOTICE**

The information in this service guide is intended for use by individuals possessing adequate backgrounds of electrical, electronic and mechanical experience. Any attempt to repair a major appliance may result in personal injury and property damage. The manufacturer or seller cannot be responsible for the interpretation of this information, nor can it assume any liability in connection with its use.

### **WARNING**

The heating element, water valve, drain solenoid, auxiliary pump (if present), detergent cup motor, active vent motor (if present) and capacitor (induction motor) are intentionally not grounded and may present a risk of electrical shock during servicing. Do not contact while appliance is energized.

### **IMPORTANT RECONNECT ALL GROUNDING DEVICES**

If grounding wires, screws, straps, clips, nuts, or washers used to complete a path to ground are removed for service, they must be returned to their original position and properly fastened.

---

## Table of Contents

<b>Dishwasher Nomenclature</b>	2
<b>Installation Highlights</b>	3
<b>"Z" Model Series Features</b>	4
<b>Cycle Selections and Options</b>	5
<b>Wash Cycles Chart</b>	6 - 7
<b>Water System and Filtering</b>	8 - 10
<b>Drain Systems</b>	11
<b>Motor</b>	12
<b>Thermistor</b>	13
<b>Turbidity Sensor</b>	13
<b>Door and Tub</b>	14
<b>Interlock Switch</b>	15
<b>Electronic Control</b>	15
<b>Active Vent</b>	15
<b>Sequence Switch</b>	16 - 17
<b>Drying Cycle</b>	18
<b>Customer Fault Cues</b>	19
<b>F1 Test Cycles</b>	20
<b>Schematic and Strip Circuits</b>	21
<b>Troubleshooting Flowchart</b>	22
<b>Exploded Views</b>	23 - 25
<b>Quick Reference Parts</b>	26 - 27
<b>Trim Kits and Accessories</b>	28
<b>Warranty</b>	29

# Dishwasher Nomenclature

## Model Number

**G S D 4 9 2 0 Z B B**

### Brand

G = GE  
H = Hotpoint  
P = RCA  
Z = Monogram

### Product Type

SD/DA/BD = Standard Dishwasher  
GE, Hotpoint, RCA, Monogram  
SC = Convertible Dishwasher  
SM = Spacemaker Dishwasher  
SS = 18" Spacemaker® Dishwasher

### Series

10 = Leader  
20 = 2 Level Wash  
30 = 3 Level Wash  
40 = GE Profile Performance™  
and GE Profile™ Models

### Exterior Color

AA = Almond  
BB = Black  
WW = White  
SS = Stainless Steel  
AD = Almond with  
black escutcheon  
WH = White with black  
escutcheon

### Model Year

Z = 1997  
C = 1998  
D = 1999

### Color

00 = Mixed  
10 = Almond on almond  
20 = Black on black  
30 = White on white  
40 = Stainless Steel door and  
access panel with black  
escutcheon

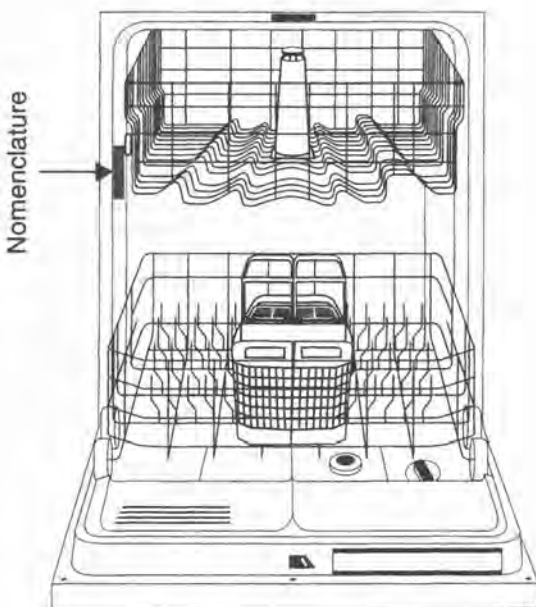

## Serial Number

The first two letters of the serial number identify the month and year of manufacture.

example.. RG123456A = August, 1992

A - JAN	1999 - V
D - FEB	1998 - T
F - MAR	1997 - S
G - APR	1996 - R
H - MAY	1995 - M
L - JUN	1994 - L
M - JUL	1993 - H
R - AUG	1992 - G
S - SEP	1991 - F
T - OCT	1990 - D
V - NOV	1989 - A
Z - DEC	1988 - Z

The letter designating the year repeats every 12 years.

example.. T - 1974  
T - 1986  
T - 1998

# Installation Highlights

## Cabinet Opening

- \* Must not be installed more than 10 feet (10') from the sink for proper drainage.
- \* Must have a minimum width and depth of 24 inches (24") for proper clearance.

## Electrical Wiring

- \* Must follow National Electrical Codes or prevailing local codes and ordinances.
- \* Must be supplied with 120V, 60Hz, and connected to an individual, properly grounded branch circuit, protected by a 15 or 20 amp circuit breaker or time delay fuse.
- \* Wiring must be 2 wire with ground.

## Hot Water Line

- \* HOT water inlet must not be less than 3/8" O.D. copper tubing or 1/2" O.D. plastic tubing.
- \* Hand shut-off in HOT water line is recommended.
- \* Follow local codes and ordinances.
- \* The drain hose must be connected to the dishwasher and pushed through the hole in the cabinet wall before installing the dishwasher into the cabinet to prevent kinking of drain hose.

GE Profile Performance™ and GE Profile™ Models

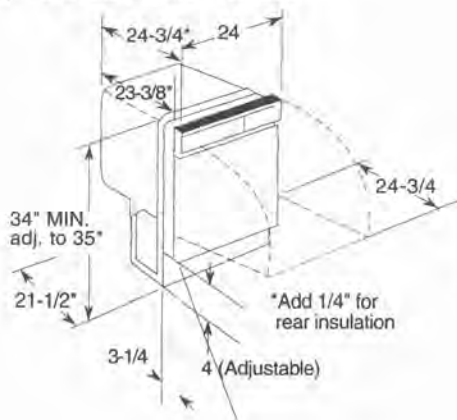

GE Models

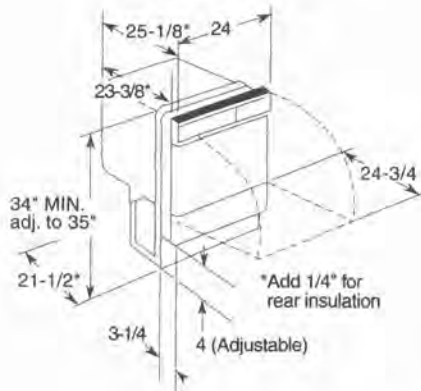

Bottom view of Profile Performance™ model

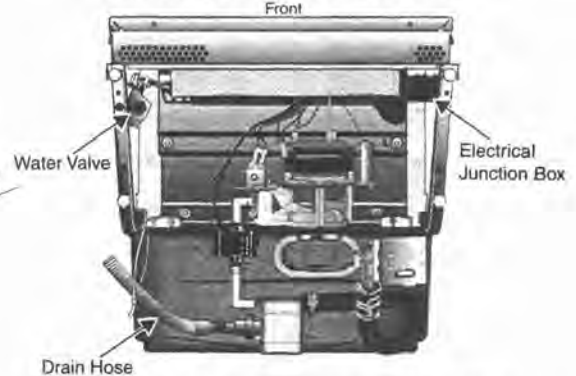

**Note:** Make certain the drain hose is connected to an air gap or installed where the drain is a minimum height of 18" above the floor to prevent siphoning.

## Dishwasher Rough-In Information

**Note:** Dishwasher must not be installed more than 10 feet from sink for proper drainage. All plumbing and electrical work must be in accordance with local codes.

**Note:** If a flush appearance is needed, a 25" base cabinet needs to be used. (GE Profile Performance™ Series and GE Profile™ models only)

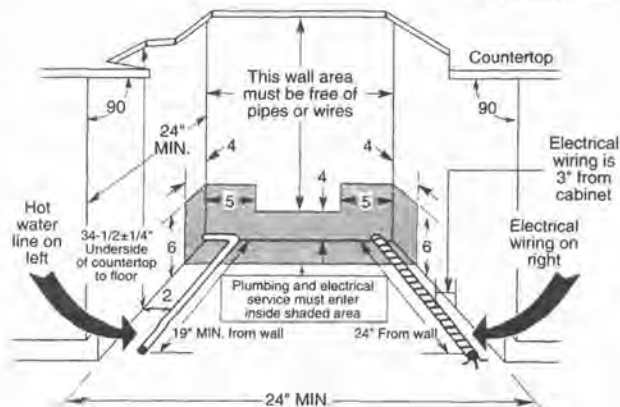

Listed by Underwriters Laboratories

### Electrical Rating

Voltage AC.....	120
Hertz.....	60
Total connected load amperage.....	8.6
Calrod heater watts.....	500

For use on adequately wired 120-volt, 15-amp circuit having 2-wire service with a separate ground wire. This appliance must be grounded for safe operation.

# "Z" Model Series Features

Model	GE						GE Profile™			GE Profile Performance™	
	GSD2000 Series GSD2200 Series (C)	GSD3200 Series	GSD3400 Series	GSD3600 Series (C) GSD3800 Series (C)	GSD4000 Series	GSD4300 Series	GSD4600 Series	GSD4900 Series			
Feature:											
Power PreSoak Option										✓	
Turbidity Sensor										✓	
Glasses Cycle										✓	
Auxiliary Pump										✓	
Sump Filter										✓	
Self-Clean Filter			✓	✓						✓	
Course Filter	✓									✓	
Hi-Temp Rinse Option										✓	
Piranha™ Anti-Jamming Hard Food Disposer			✓							✓	
Induction Motor			✓							✓	
Shaded Pole Motor	✓										
Soft Food Disposer	✓										
3 Level Wash System			✓							✓	
Hi-Temp Wash Option			✓							Auto	
2 Level Wash System	✓										
Natural Convection Dry	✓		✓							✓	
120° Inlet Water Capability	✓		✓							✓	
500W Calrod Heating Element	✓		✓							✓	

(C) = Contract only models



GE Profile™ Models

**CLEAN** Use to start or reset a cycle. Reset takes approximately 60 seconds. During reset, sensor models will flash the Washing LED and non-sensor models will flash the Start/Reset LED.

**START RESET**

GE Profile Performance™ Models

**STATUS**

**SENSING** Displayed during sensing using turbidity sensor

**WASHING** Displayed during prewash and main wash periods

**RINSING** Displayed during rinse periods

**DRYING** Displayed during heated dry only

**CLEAN** Displayed when cycle is complete  
Light remains on until door is opened

**LOAD/CYCLE SELECTIONS**

**NORMAL** This cycle is for most loads of everyday dishes, glasses, and cookware with medium soil levels.

**POTS PANS** Use to remove tough soils from pots and pans. It will not remove burned-on foods.

**POT-SCRUBBER**

**LIGHT WASH** Use for everyday dishes with light to medium soil levels where the soils have not dried on.

**CHINA CRYSTAL** Use for delicate washing of fine dishware and crystal with light to medium soil levels.

**GLASSES** Use when the majority of the load is glassware requiring a short wash time and heated post rinses to aid drying.

**RINSE & HOLD** Used to rinse a partial load before soils are dried on and hold until the dishwasher is ready for a wash cycle.

**OPTIONS**

**POWER PRESOAK** This option must be selected prior to the start of the wash cycle and will add one additional prewash cycle lasting 15 minutes.

**HI TEMP WASH** This option will energize the heater in all prewash fill cycles. If the wash cycle has already started, it will not take effect until the beginning of the next fill cycle. This option is not available on the Rinse and Hold cycle.

**HI TEMP RINSE** This option will energize the heater in all pre-rinse and post-rinse cycles. If the rinse cycle has already started, it will not take effect until the beginning of the next fill cycle.



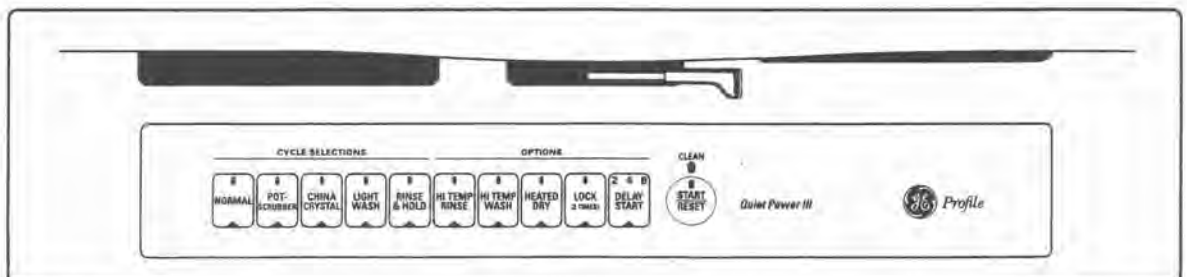
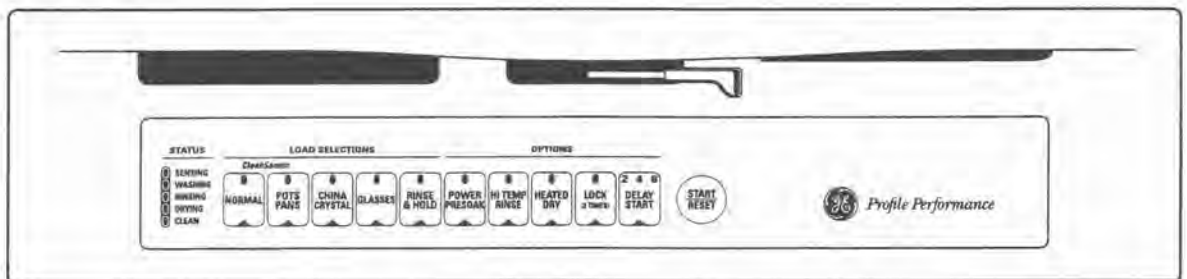

**HEATED DRY** Turns on the 500 watt heater calrod during dry. This option extends the cycle for an additional 30 min. NOTE: After a power outage, the heated dry option will be on. This option is not available on the Rinse and Hold cycle.

**LOCK (2 TIMES)** Pressing lock twice within 3 seconds will deactivate all keypads except for the LOCK pad. The lock LED will stay on whether the cycle is running or not.

**2 4 8 DELAY START** Postpones the start of the wash cycle. Each successive push turns on the next delay LED and sets the countdown timer. Unlocking the door pauses the delay start countdown.



## Wash Cycle Chart GE Profile Performance™ (4900 & 4600 series)





Cycle	Total Gallons								Cycle Summary
<b>POTSCRUBBER</b>  58-66 Minutes (Variable)	7.5 min to 10.5 max (5-7 fills)	<b>Pre-Wash/Rinse</b> HEATED CircuClean 1.4 gals. 4 minutes	<b>Pre-Rinse</b> HEATED CircuClean 1.5 gals. 4 minutes	<b>Pre-Rinse</b> HEATED CircuClean 1.5 gals. 4 minutes	<b>Pre-Rinse</b> HEATED CircuClean 1.5 gals. 4 minutes	<b>Main Wash</b> HEATED CircuClean 1.6 gals. 40 minutes	<b>Post-Rinse</b> CircuClean 1.5 gals. 4 minutes	<b>Post-Rinse</b> 1.5 gals. 4 minutes	Variable cycle selects up to 4 pre-rinse fills (based on drain soil level). Cycle auto-initiates Hi-Temp wash & CircuClean pump to maximize soil removal for dried & baked-on foods.
<b>NORMAL WASH</b>  53-62 Minutes (Variable)	7.5 min to 10.5 max (5-7 fills)	<b>Pre-Wash/Rinse</b> HEATED CircuClean 1.4 gals. 4 minutes	<b>Pre-Rinse</b> HEATED CircuClean 1.5 gals. 4 minutes	<b>Pre-Rinse</b> HEATED CircuClean 1.5 gals. 4 minutes	<b>Main Wash</b> HEATED CircuClean 1.6 gals. 40 minutes	<b>Post-Rinse</b> CircuClean 1.5 gals. 4 minutes	<b>Post-Rinse</b> 1.5 gals. 4 minutes	Variable cycle selects up to 3 pre-rinse fills (based on drain soil level). Cycle auto-initiates Hi-Temp wash & the CircuClean pump removes soils after each drain to maximize wash performance.	
<b>CHINA/CRYSTAL</b>  33 Minutes	6.1			<b>Pre-Rinse</b> HEATED CircuClean 1.5 gals. 4 minutes	<b>Main Wash</b> HEATED CircuClean 1.6 gals. 20 minutes	<b>Post-Rinse</b> CircuClean 1.5 gals. 4 minutes	<b>Post-Rinse</b> 1.5 gals. 4 minutes	Developed in cooperation with Lenox® Crystal to provide optimum cleaning results for fine china and crystal. This cycle limits exposure to heat & harsh detergents reducing the potential for breakage & etching.	
<b>GLASSES</b>  31 Minutes	4.6				<b>Main Wash</b> HEATED CircuClean 1.6 gals./ Rinse-Aid 20 minutes	<b>Post-Rinse</b> CircuClean 1.6 gals. 4 minutes	<b>Post-Rinse</b> 1.6 gals./ Rinse-Aid 4 minutes	Fixed time cycle designed for the most commonly used everyday dish-GLASSES. Two heated post-rinse, and no Pre-Rinse provide 25-50% water savings vs. normal wash.	
<b>RINSE &amp; HOLD</b>  4 Minutes	1.5					<b>Rinse</b> 1.5 gals. 4 minutes		This cycle provides one rinse fill for partial dishloads. The dishwasher then "holds" the dishes until you have a full load to wash.	
<b>POWER PRE-SOAK (OPTION)</b> GSD4900Z Only 15 Minutes	1.4	<b>Pre-Wash</b> HEATED 1.4 gals. 15 minutes							Option can be used in conjunction with any cycle. Provides additional 15 minutes pre-wash to help loosen dried or baked-on food soils before advancing into pre-selected cycle.

- \* Hi-Temp Wash Option is operated automatically on all CleanSensor II models
- \* Hi-Temp Rinse Option provides heated water in all Post-Rinse
- \* Heated Dry Option adds approx. 30 minutes to overall cycle time.



### IMPORTANT INFORMATION

All cycle times include fill and drain time

Cycle	Total Gallons								Cycle Summary
<b>POTSCRUBBER</b>  67 Minutes	10.5	<b>Pre-Wash/Rinse</b> CircuClean 1.4 gals. 4 minutes	<b>Pre-Rinse</b> CircuClean 1.5 gals. 4 minutes	<b>Pre-Rinse</b> CircuClean 1.5 gals. 4 minutes	<b>Pre-Rinse</b> CircuClean 1.5 gals. 4 minutes	<b>Main Wash</b> HEATED CircuClean 1.6 gals. 40 minutes	<b>Post-Rinse</b> CircuClean 1.5 gals. 4 minutes	<b>Post-Rinse</b> 1.5 gals. 4 minutes	CircuClean pump (and sump filter) provides four clean water pre-rinse fills. Additional fill and pump are used to loosen and remove excess and dried & baked-on food soils.
<b>NORMAL WASH</b>  62 Minutes	9	<b>Pre-Wash/Rinse</b> CircuClean 1.4 gals. 4 minutes	<b>Pre-Rinse</b> CircuClean 1.5 gals. 4 minutes	<b>Pre-Rinse</b> CircuClean 1.5 gals. 4 minutes	<b>Main Wash</b> HEATED CircuClean 1.6 gals. 40 minutes	<b>Post-Rinse</b> CircuClean 1.5 gals. 4 minutes	<b>Post-Rinse</b> 1.5 gals. 4 minutes	The most commonly used cycle provides vigorous wash action for everyday dishloads. The CircuClean pump (and sump filter) is initiated to remove soiled water and increase performance.	
<b>LIGHT WASH</b>  53 Minutes	6.7			<b>Pre-Rinse</b> CircuClean 1.4 gals. 4 minutes	<b>Main Wash</b> HEATED CircuClean 1.6 gals. 40 minutes	<b>Post-Rinse</b> CircuClean 1.5 gals. 4 minutes	<b>Post-Rinse</b> 1.5 gals. 4 minutes	Ideal for pre-rinse or lightly soiled dishloads. Eliminates two pre-wash/rinse fills for 25% water savings when compared to normal wash.	
<b>CHINA/CRYSTAL</b>  33 Minutes	6			<b>Pre-Rinse</b> CircuClean 1.4 gals. 4 minutes	<b>Main Wash</b> HEATED CircuClean 1.6 gals. 20 minutes	<b>Post-Rinse</b> CircuClean 1.5 gals. 4 minutes	<b>Post-Rinse</b> 1.5 gals. 4 minutes	Developed in cooperation with Lenox® Crystal to provide optimum cleaning results for fine china and crystal. This cycle limits exposure to heat & harsh detergents reducing the potential for breakage & etching.	
<b>RINSE &amp; HOLD</b>  4 Minutes	1.5					<b>Rinse</b> 1.5 gals. 4 minutes		This cycle provides one rinse fill for partial dishloads. The dishwasher then "holds" the dishes until you have a full load to wash.	

- \* Hi-Temp Wash Option provides heated water in all Pre-Wash/Rinse fills.
- \* Hi-Temp Rinse Option provides heated water in all Post-Rinse.
- \* Heated Dry Option adds approx. 30 minutes to overall cycle time.



### IMPORTANT INFORMATION

All cycle times include fill and drain time











Cycle

Total  
Gallons

## Wash Cycle Chart (GSD4000Z series)

Cycle Summary

<b>POTSCRUBBER</b>  64 Minutes	9.4	<b>Pre-Wash/ Rinse</b>  1.4 gals. 4 minutes	<b>Pre-Rinse</b> 1.4 gals. 4 minutes	<b>Pre-Rinse</b> 1.3 gals. 4 minutes	<b>Main Wash</b>  HEATED 1.4 gals. 40 minutes	<b>Post-Rinse</b> 1.3 gals. 4 minutes	<b>Post-Rinse</b> 1.3 gals. 4 minutes	<b>Post-Rinse</b> 1.3 gals. 4 minutes	Heated main wash combined with 1 additional pre-rinse fill, provides the "scrubbing" action needed to loosen dried & baked-on foods.
<b>NORMAL WASH</b>  62 Minutes	8	<b>Pre-Wash/ Rinse</b>  1.4 gals. 4 minutes		<b>Pre-Rinse</b> 1.3 gals. 4 minutes	<b>Main Wash</b>  HEATED 1.4 gals. 40 minutes	<b>Post-Rinse</b> 1.3 gals. 4 minutes	<b>Post-Rinse</b> 1.3 gals. 4 minutes	<b>Post-Rinse</b> 1.3 gals. 4 minutes	The most commonly used cycle provides vigorous wash action for everyday dishloads.
<b>LIGHT WASH</b>  56 Minutes	6.7			<b>Pre-Rinse</b> 1.4 gals. 4 minutes	<b>Main Wash</b>  HEATED 1.4 gals. 40 minutes	<b>Post-Rinse</b> 1.3 gals. 4 minutes	<b>Post-Rinse</b> 1.3 gals. 4 minutes	<b>Post-Rinse</b> 1.3 gals. 4 minutes	Ideal for pre-rinsed or lightly soiled dishloads. Eliminates pre-wash/rinse fill for 20% water savings when compared to normal wash.
<b>RINSE &amp; HOLD</b>  4 Minutes	1.5					<b>Rinse</b> 1.5 gals. 4 minutes			This cycle provides one rinse fill for partial dishloads. The dishwasher then "holds" the dishes until you have a full load to wash.

\* **Hi-Temp Wash Option** provides heated water in all Pre-Wash/Rinse fills.\* **Hi-Temp Rinse Option** provides heat in all Post-Rinse.

\* Heated Dry adds approx. 30 minutes to overall cycle time.

**IMPORTANT INFORMATION**











All cycle times include fill and drain time

Cycle

Total  
Gallons

## Wash Cycle Chart (GSD3600Z series)

Cycle Summary

<b>POTSCRUBBER</b>  61.5 Minutes	9.4	<b>Pre-Wash/ Rinse</b>  HEATED 1.4 gals. 5 minutes	<b>Pre-Rinse</b> HEATED 1.4 gals. 4 minutes	<b>Pre-Rinse</b> HEATED 1.3 gals. 4 minutes	<b>Main Wash</b>  HEATED 1.4 gals. 35.5 minutes	<b>Post-Rinse</b> HEATED 1.3 gals. 4 minutes	<b>Post-Rinse</b> HEATED 1.3 gals. 4 minutes	<b>Post-Rinse</b> HEATED 1.3 gals. 5 minutes	Water is auto. heated thru all stages of the cycle. The heated water combined with 1 additional pre-rinse fill, provides the "scrubbing" action needed to loosen dried & baked-on foods.
<b>NORMAL WASH</b>  61.5 Minutes	8	<b>Pre-Wash/ Rinse</b>  HEATED 1.4 gals. 5 minutes		<b>Pre-Rinse</b> 1.3 gals. 4 minutes	<b>Main Wash</b>  HEATED 1.4 gals. 35.5 minutes	<b>Post-Rinse</b> 1.3 gals. 4 minutes	<b>Post-Rinse</b> 1.3 gals. 4 minutes	<b>Post-Rinse</b> 1.3 gals. 5 minutes	The most commonly used cycle provides vigorous wash action for everyday dishloads.
<b>WATER SAVER</b>  61.5 Minutes	6.7			<b>Pre-Rinse</b> 1.3 gals. 4 minutes	<b>Main Wash</b>  HEATED 1.4 gals. 35.5 minutes	<b>Post-Rinse</b> 1.3 gals. 4 minutes	<b>Post-Rinse</b> 1.3 gals. 9 minutes		For lightly soiled dishloads. This cycle saves water by using 20% less water than the normal cycle.
<b>SHORT WASH</b>  52.5 Minutes	6.6			<b>Pre-Rinse</b> 1.3 gals. 4 minutes	<b>Main Wash</b>  HEATED 1.4 gals. 35.5 minutes	<b>Post-Rinse</b> 1.3 gals. 4 minutes	<b>Post-Rinse</b> 1.3 gals. 4 minutes	<b>Post-Rinse</b> 1.3 gals. 5 minutes	Clean pre-rinsed or lightly soiled dishloads. Eliminates pre-wash/rinse fill for 20% water savings compared to normal wash.

## Water Valve



All GE Profile Performance™ and some GE Profile™ "Z" model dishwashers use the quiet water valve WD15X0096. This valve minimizes water inlet noise by reducing the water flow rate to approximately 1.25 gallons per minute. The standard water valve used on all other models, WD15X0093, has a flow rate of approximately 1.75 gallons per minute. The coil resistance is approximately 850 ohms for both valves. **On electronic models, water enters the tub for about 40 seconds before the main motor begins to operate, then continues to fill as the motor is running.**

**NOTE:** The fill times vary by model and the type of valve used. *Use only the exact replacement water valve. The wrong valve will affect the amount of water entering into the dishwasher and wash performance.*

## Flood Float Switch

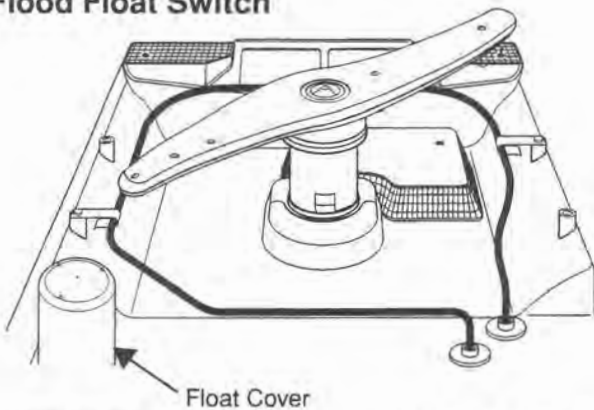

The flood switch is located under the tub at the left front corner. The switch remains closed by the weight of the float, supplying a circuit to the water valve. A cover (held by a 1/4" hex screw) inside the tub protects the float from "wave action" and debris which could affect its operation. The float should always be free and unrestricted, allowing its weight to keep the switch in a closed position. *The flood switch is a safety device and does not control the amount of water in the tub!* The timer or electronic control regulates the amount of time the water valve is open. If the control fails and keeps the valve energized, the overfilling of the tub will cause the float to lift and open the circuit to the water valve. The flood switch will not stop the flow of water if the valve sticks open from a mechanical failure.

## Wash System

All "Z" model dishwashers having a 3 level wash system utilize a **one piece venturi spray arm assembly**. To remove the wash arm, insert a screwdriver into the two tabs on the wash arm hub to release it. To remove the hub, insert a screwdriver into the two tap holes and break the locking tabs by turning with the screwdriver.

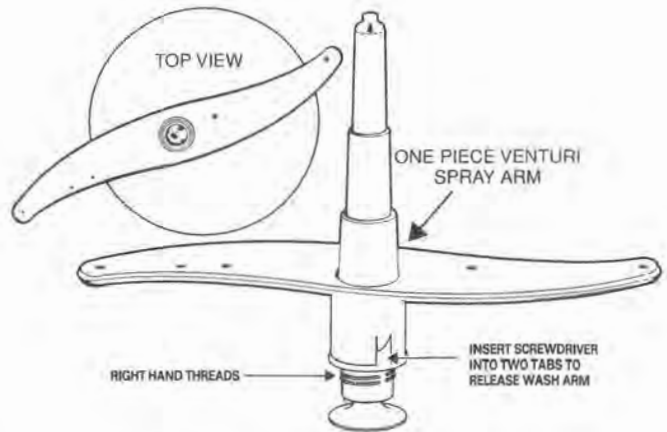

The 3 level wash systems no longer have an upper wash arm at the top of the tub. They utilize a tower attached to the upper rack. The venturi wash arm forces a "jet stream" of water up into the tower which directs the flow of water downward onto the glasses and dishware.

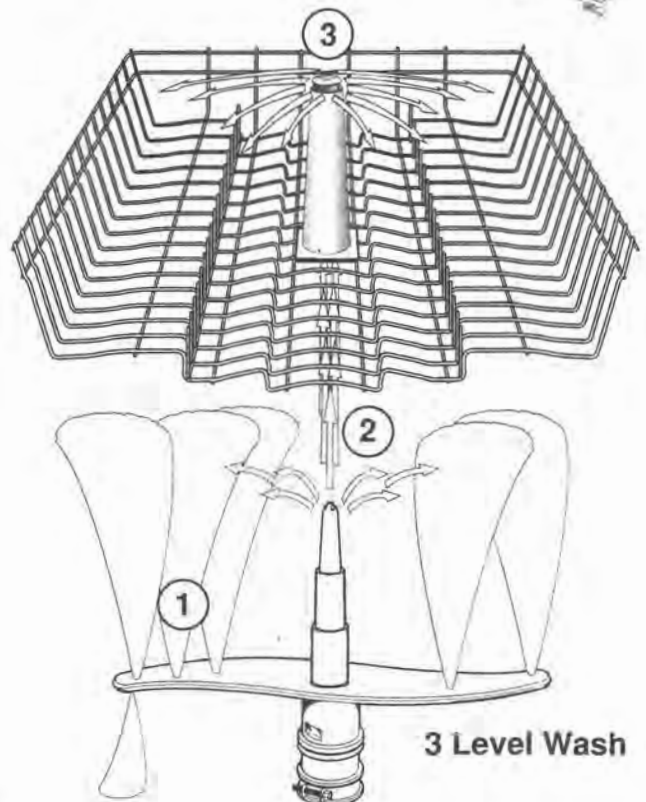

# WATER DISTRIBUTION SYSTEM

## Wash Cycle

**Note:** some components not on all models

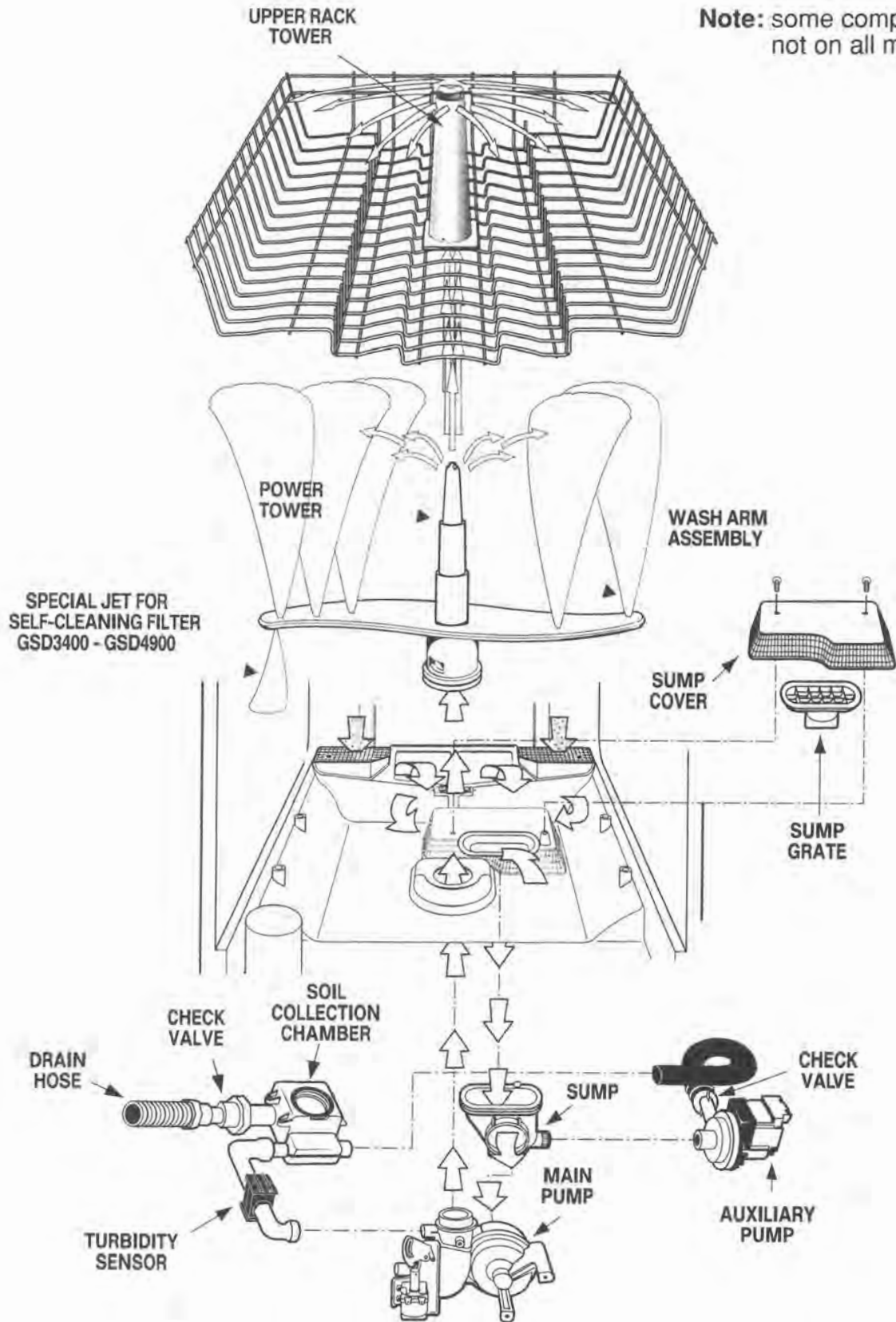

## Wash Cycle Filtering

All "Z" model dishwashers have a coarse grate at the top of the sump and around the sides of the sump cover. These grates help to prevent large items from reaching the pump.

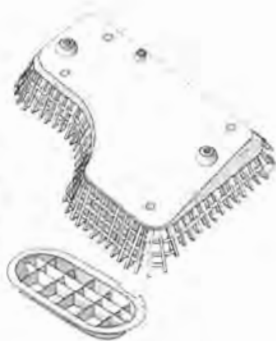

All GSD3400Z through GSD4900Z series also have a self-cleaning filter at the back of the tub. Water enters this filter from the top through coarse grates and exits through a fine mesh screen in the front. The fine mesh screen is automatically cleaned by a special spray jet on the underside of the wash arm. Soil collected on the back side of the screen will settle into the collection chamber below, where it will be washed away during the drain cycle.

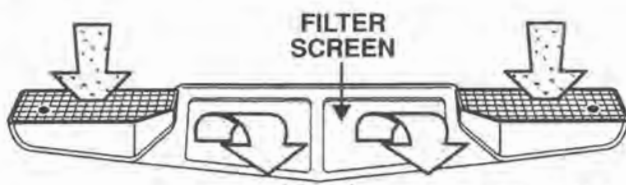

Soil trapped behind the filter screen settles out into the collection chamber.

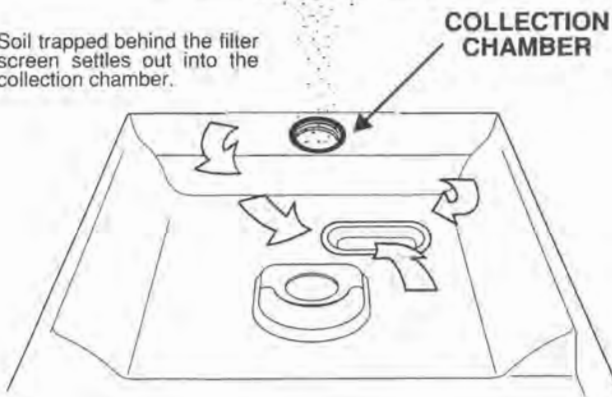

An additional third filtering device is included on all GSD4300Z, GSD4600Z, and GSD4900Z series. This method adds a fine filter to the grate within the sump area and traps food soils ground in the hard food disposer until the next drain cycle, increasing filtration effectiveness.

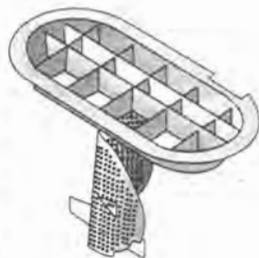

## Collection Chamber Operation by Cycles

### Wash & Rinse Cycles

During wash and rinse, soil will settle down into the collection chamber where it will accumulate.

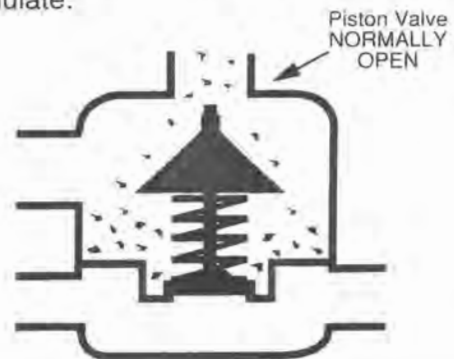

### Drain Cycle

In the drain cycle, water from the pump forces the piston valve to lift and close off the tub opening, directing the soil accumulation out the drain.

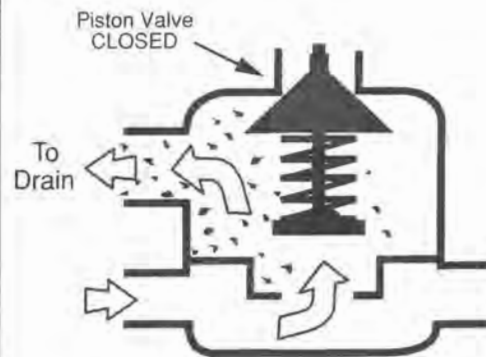

### Auxiliary Drain Cycle (not on all models)

During auxiliary drain, only the auxiliary pump will run, pumping water into the collection chamber, lifting the piston and forcing the remaining water out the drain.

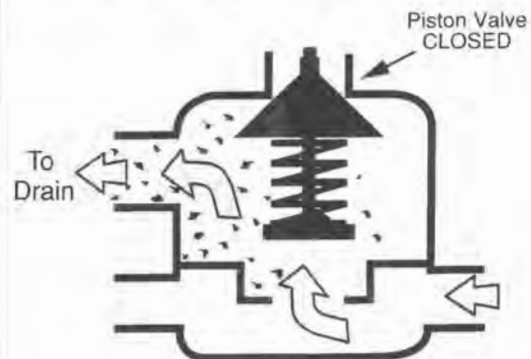



## MAIN PUMP DRAIN CYCLE

(on models with a collection chamber)

At the start of the drain cycle, the drain solenoid is energized with 120 VAC for approximately 5-10 seconds on electronic "Z" models, lifting a spring loaded flapper (gate valve) inside the main pump. The gate valve closes off the flow of water through the spray arm and directs the water into the collection chamber. The force of the water from the pump holds the gate valve up and the water entering the collection chamber pushes upward on a piston, closing the opening into the tub and directing water out the drain line. The water flowing through the collection chamber picks up the soil that had previously accumulated in the chamber during the wash and rinse cycles and flushes it out the drain. The main pump is energized for 60 seconds in the drain mode, unless the cycle calls for the auxiliary pump (if applicable), in which case the main pump will operate for 40 seconds.

The check valve located in the drain line at the outlet of the collection chamber prevents waste water from reentering the tub. On models with an auxiliary pump, a check valve located at the outlet of the auxiliary pump prevents drain water from entering the auxiliary pump and sump when the main pump is operating in a drain cycle.

**NOTE:** If no-drain problems occur, one possibility may be the rubber check valve in the auxiliary pump may be damaged or missing. Also, a damaged or "stuck open" piston in the collection chamber will cause the water to circulate through the tub rather than being forced down the drain.

If you suspect an obstruction in the drain hose, it is not possible to clear the hose by blowing through it without removing the hose from the collection chamber. This is due to the check valve allowing water to flow in only one direction.

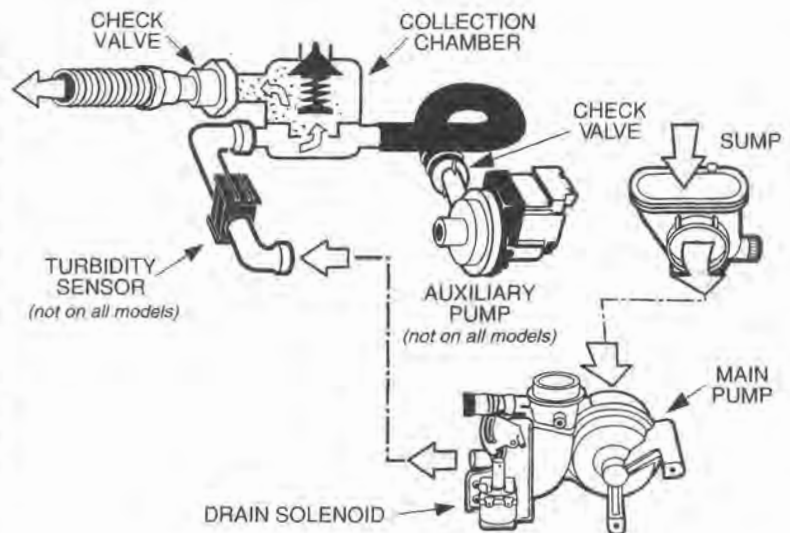

## AUXILIARY PUMP DRAIN CYCLE

(on selected models)

The auxiliary drain pump operates on 120 VAC and is energized in selected cycles for 20 seconds after the main pump has operated for 40 seconds and removed the majority of water from the tub. The main pump is turned off and the auxiliary pump removes all the remaining water, including all water from the sump area. This allows the dishwasher to fill completely with clean water during the next fill cycle. As water is forced through the auxiliary pump check valve, the water is directed only into the collection chamber and out the drain line. The closed gate valve in the main pump prevents water from reentering the tub through the main pump. The water pressure pushing up on the piston in the collection chamber prevents water from reentering the tub from the collection chamber.

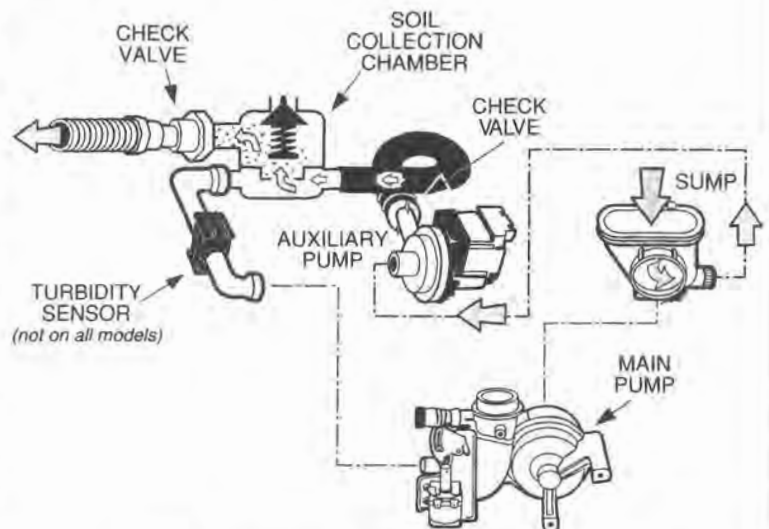

**NOTE:** The check valve flapper in the auxiliary pump is beveled on one side and marked OUT on the other. The side marked OUT should face towards the collection chamber.



## Induction Motor

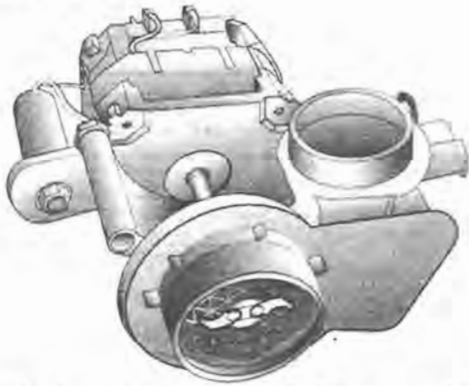

All electronic and some electromechanical models use the quiet, capacitor start induction motor. This motor rotates clockwise (as viewed from the terminal end) at approximately 3100 rpm and draws approximately 1.8 amps at 120 VAC. It has a resistance of 10 ohms ( $\pm 2$ ).

**NOTE:** The capacitor comes with the motor and is not currently available as a separate part.

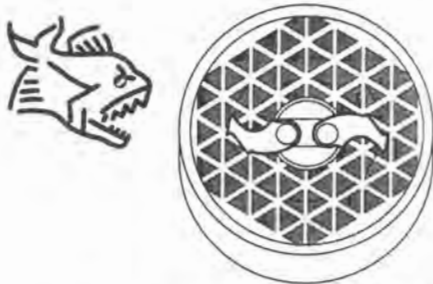

The induction motors use the new Piranha™ anti-jamming food disposer cutter blade. This dual-swivel impeller is made of "300 series" stainless steel.

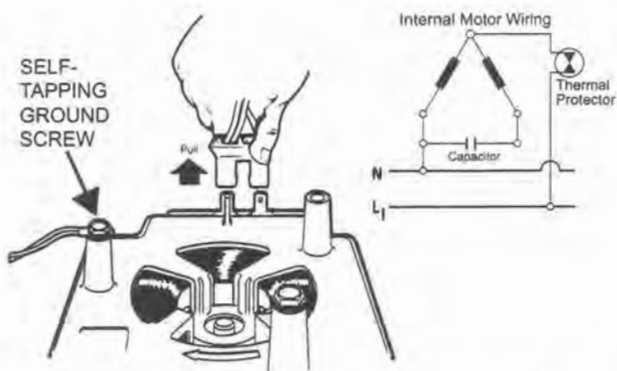

The terminals on the induction motor are labeled L1 and N. The motor is thermally protected (internally) through the L1 side. The wiring connector is color-coded blue to match the blue wire leading to the motor and is designed to fit on the terminals only one way. Make certain that the connector is fully seated when installing.

**NOTE:** It is extremely important that the self-tapping grounding screw is tightened securely.

## Shaded Pole Motor



Most electromechanical models use the shaded pole motor. This motor rotates clockwise (as viewed from the terminal end) at approximately 3100 rpm and draws approximately 3.4 amps at 120 VAC. It has a resistance of 2 ohms ( $\pm 1$ ).

## Troubleshooting the Motor

On "Z" models with electronic controls, it is important to remember the motor does not start immediately when the dishwasher cycle has started. The tub will begin filling with water and the motor will start approximately 40 seconds into the fill cycle. If the motor hums, but will not start, make certain the pump impeller is free from obstructions and the motor shaft can turn freely. Note, on the induction motor models, if the capacitor is open or shorted, the motor will hum and will not start. Check for 120 VAC at the motor terminals. Take the voltage measurement while "under load" (as the motor is trying to start). This will eliminate any possibilities of poor wiring connections. If 120 VAC is present and the motor will not start, the motor will have to be replaced.

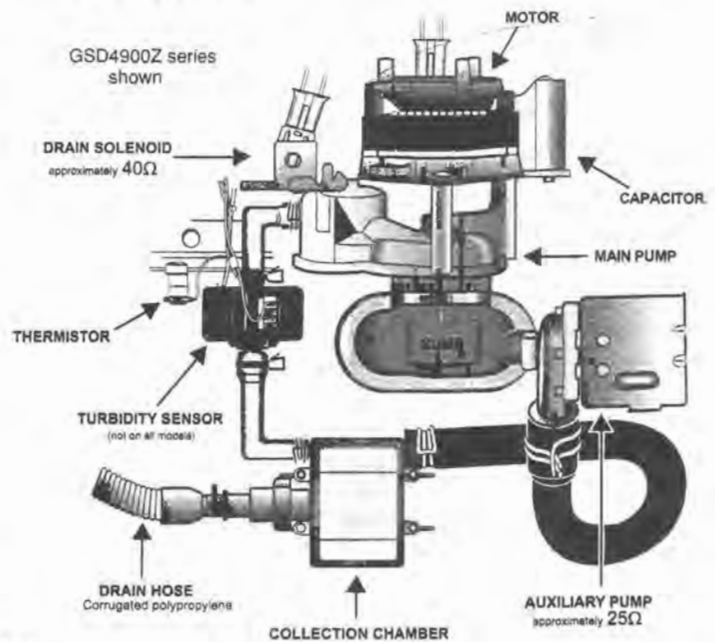

## Dishwasher Door and Tub

All "Z" models have an "aluminum wrap" outer door panel. This outer panel is a one-piece unit, eliminating all exterior trim. The panel is attached to the door hinges with six Torx T-20 screws. The escutcheon is attached to the outer door panel with four Phillips screws on the Profile™ and Profile Performance™ models. All other models use two screws. The wire harness runs down the center of the outer panel, between pads of insulation. A replacement outer door panel can be installed over the existing panel if excessive damage to the old panel has not occurred. By removing the two bottom Torx screws, the new panel can be slipped under the escutcheon and wrapped over the old panel.

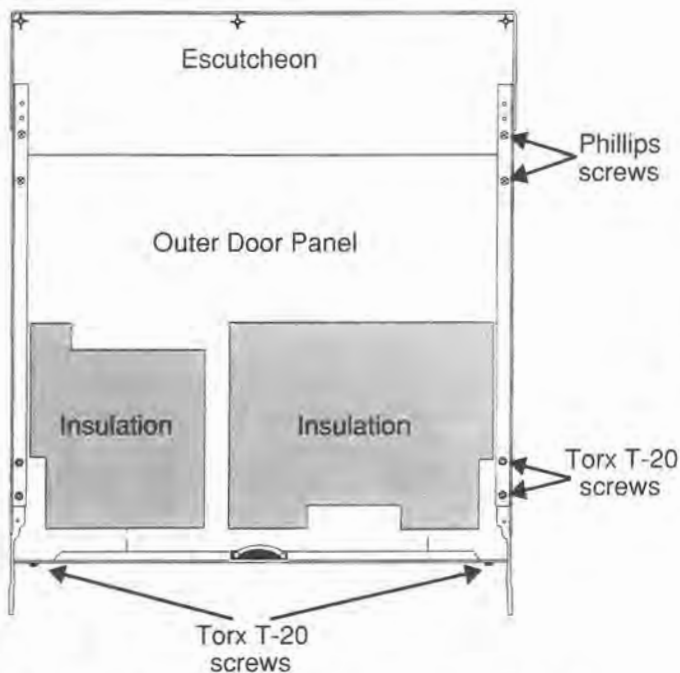

The door springs are side mounted. The springs are adjustable by moving the bottom spring hook to a different hole in the lower leg channel. The springs are color coded for different models and tensions:

Yellow - 26.5 lbs.

Red - 21.5 lbs.

White - 20.0 lbs.

Orange - 18.0 lbs.

Refer to the parts list for the correct tension.

NOTE: It is important to make certain the springs are not rubbing against the **fill hose** or cabinets after installation or when a repair is made.

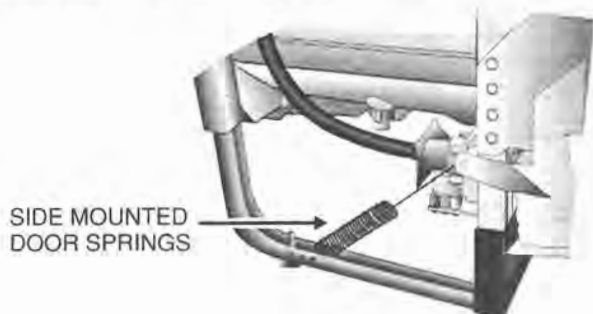

The PermaTuf® interior door panel contains the rinse agent tank and soap dispenser mechanism. Some models have a thermal mastic attached to the inner door to help reduce sounds and reduce water temperature loss during circulation.

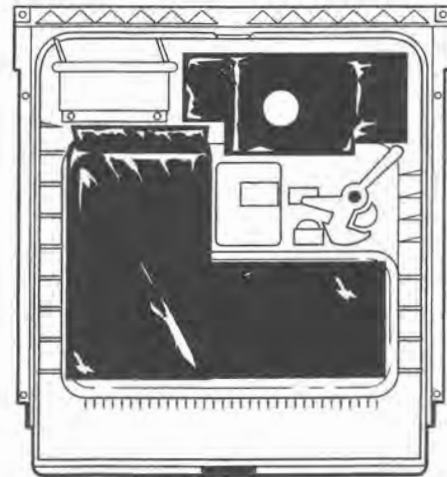

MASTIC DOOR INSULATION  
PROFILE PERFORMANCE™ MODEL

The door gasket is a one piece gasket with a serrated lip that fits into a channel in the inner door panel. The gasket fits completely around the door except for the bottom middle, where the gasket insert is installed. The gasket insert is made of the same material as the gasket, but has slots in it to allow for water flushing action.



The PermaTuf® dishwasher tub is a one piece polypropylene (heavy-duty plastic) and is not replaceable. The tub is covered with a fiber insulation blanket to reduce sound. Some models have thermal mastic to improve sound deadening capabilities and reduce heat loss.

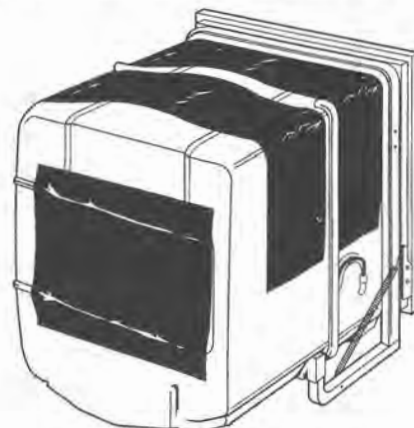

MASTIC TUB INSULATION  
PROFILE PERFORMANCE™ MODEL

## Door Components

The door components are accessed by separating the inner and outer door panels. This is done by removing the seven Phillips screws from around the edge of the inner door panel (note the different thread patterns), and the one small Phillips screw from the underside of the latch knob. Carefully separate the door panels, keeping the latch mechanism with the inner door. Raise the inner door panel and latch it to the tub to hold it in place.

## Door Interlock Switch

This assembly contains two switches and will break both sides of the electrical line. It is held in place by two screws to the escutcheon.

**NOTE:** Make certain that the latch mechanism fits within the curved portion of the interlock switch when reassembling the door.

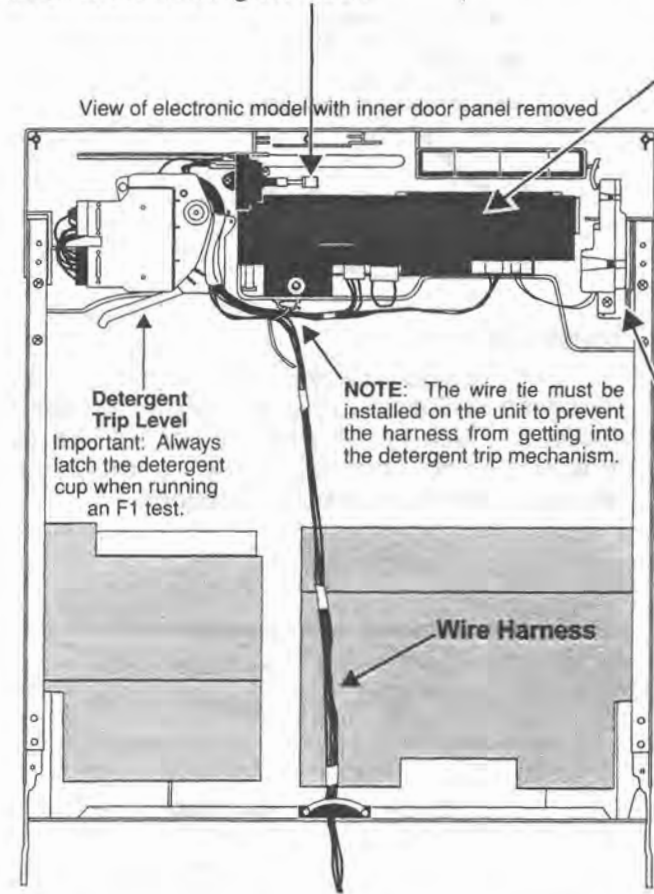

The wire harness runs up the center of the outer door panel and is held in place by a retaining clip at the bottom of the door and a wire tie at the control. It is very important for the wiring to be secured and clear of the detergent trip lever. Should the wiring or connectors become damaged, a complete harness assembly is available for the Profile™ and Profile Performance™ models as WD21X10025. The harness includes both the DC low voltage and AC line voltage wiring, the flood switch, the tub thermistor and all harness connector plugs.

## Electronic Control

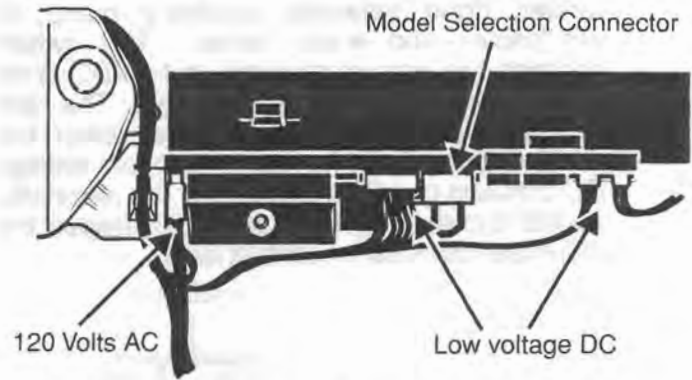

There are two types of electronic controls; turbidity sensor and non-turbidity sensor. The sensor control (WD21X10004), is used on Profile Performance™ models and has a vertical row of status display lights to the left of the selector pads. The non-sensor controls (WD21X10003 and WD21X10006), are used on Profile™ models and have the clean LED above the start pad. The model selection connector determines which dishwasher features are activated in the control. The connector is NOT supplied with a replacement control and must be transferred from the old control.

**NOTE:** When servicing, check all wiring for loose connections at harness, connector plugs, and control pins first. Loose pins or wiring is the most likely cause for erratic operation of the control!

## Active Vent



The active vent helps to reduce the noise level and heat loss when in the closed position. The vent uses the same type DC motor as the sequence switch. The electronic control supplies +/-14 VDC to the motor. The control reverses polarity to drive the motor in a clockwise or counterclockwise direction. Once the vent door is driven to the open or closed position, the motor stalls, drawing 125 milliamps. The electronic control senses this current draw and recognizes that the proper vent position has been reached. If you suspect a problem, remove the leads and check for 14 VDC at the control. The vent is closed during the wash cycle and open during the drying cycle or when the unit is not in use. If the vent is closed and the door is unlatched during the wash cycle, the vent will open. When the door is latched again, the vent will remain open for seven (7) seconds, then close again to finish the cycle.



## Sequence Switch

The sequence switch controls power to the 120V components: the motor pump assembly, heater, drain solenoid, auxiliary pump (if applicable) and water valve. The switch contains two sets of contacts, a 14 VDC drive motor and a molded cam (or platter). The cam has molded "raises", which lift or lower the metal fingers of the contacts. The low voltage DC contacts provide feedback to the electronic control and the 120 VAC contacts energize the individual dishwasher components.

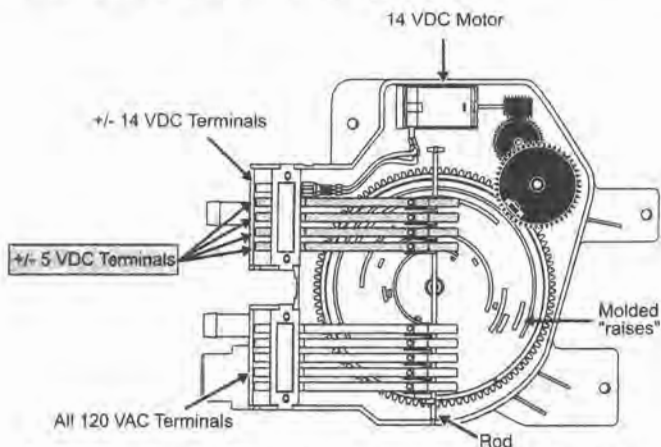

**NOTE:** Do NOT attempt to disassemble and repair the sequence switch. If you determine the switch to be at fault, it should be replaced and is available only as a complete assembly.

The sequence switch's drive motor receives +14 VDC or -14 VDC from the electronic control. The voltage can be measured between the orange and blue wires on the white connector plug while the motor is running. It is important to note that the motor does not continuously receive voltage from the control. The electronic control will only supply +/- 14 VDC to the sequence switch motor when necessary to change the position of the 120V contacts and operate a component or change a cycle. The cam is able to rotate in a clockwise or counter-clockwise direction based on the DC polarity supplied to the motor. When the cam rotates in a counter-clockwise direction, the sequence switch will break power to all components and de-energize them. This is accomplished by a rod located under the metal fingers which lifts the contacts off the molded cam and opens all circuits whenever the cam is driven in a counter-clockwise direction.

**NOTE:** The sequence switch does NOT run continuously. The motor only drives the cam when necessary to activate (or deactivate) a component or change a cycle.

As a safety feature, when the selected cycle is completed and the switch is returned to its "home" position, the final rotation is counter-

clockwise to assure that all components are de-energized. The home position is marked on the cam by a small letter "H" in a circle as shown in the illustration below. The switch must be removed from the escutcheon for the "H" to be visible through the opening on the back of the switch cover. The sequence switch should always return to the home position at the end of the selected cycle or when "reset" has been activated. *Reset can take up to 60 seconds to complete.*

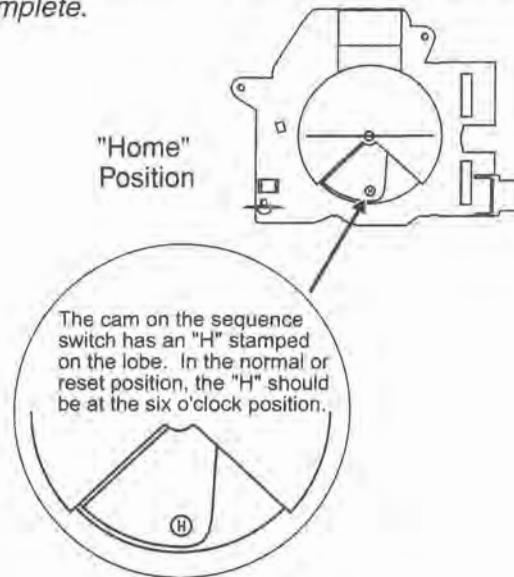

## Switch Operation

The "molded raises" on the cam in the sequence switch are divided into four different sections. Each of the sections control specific functions and energize the components necessary for those specific functions.



The cam will rotate in both directions through sections 1 and 3. For example; In a normal wash cycle, the cam will rotate in a clockwise direction beginning in section 1 and the unit will fill with water for prewash. About 40 seconds into filling, the cam will rotate a little further in section 1 and the main pump will come on. The dishwasher will begin to circulate the water

as it continues to fill. When the dishwasher completes the prewash wash time, the switch rotates the cam further in section 1 and the main pump (and auxiliary pump if applicable) drains the water from the tub. After the prewash is complete, the cam will then rotate counter-clockwise back to the beginning of section 1 and begin a second fill. When all the prewashes are complete, the cam will rotate clockwise into section 2 and trip the detergent cup. After the cup has opened, the cam will continue to rotate into section 3 and begin the fill for main wash.

**NOTE:** It is normal operation for the soap cup to open and dispense soap into the tub when the main pump is off and there is no water in the tub!

For information on the disassembly and repair of the detergent cup and rinse aid assemblies, refer to *Technician Manual Pub. No. 31-3281*.

The sequence switch is also designed so a counter-clockwise rotation of the cam through either sections 2 or 4 will cause the switch to stall. This is caused by the detergent trip lever catching in the notches (or cam drops) on the backside of the cam. Under normal conditions, the sequence switch should never rotate counter-clockwise through these sections. The switch is designed to run backwards into a stall when the control cannot determine the switch's position. This insures that no load is activated until the dishwasher's problem is corrected. If this problem ever does occur, the trip lever will be held by the cam and you will be unable to move it. In the following order, check these possibilities:

1. The electronic control received a false signal and is confused as to the switch's position. Disconnect power for a minimum of 10 seconds, reconnect power and attempt to reset the dishwasher.
2. A poor electrical connection or broken wire is preventing the control from receiving the correct feedback signal. Check the wiring.
3. The sequence switch is bad and requires replacement.
4. The electronic control is bad and requires replacement.

After completing the main wash and post rinse cycles, the cam will rotate into section 4 and dispense the rinse agent. It will continue to rotate clockwise into section 1 again, where the cam will activate the final rinse cycles. At the end of the dishwasher cycle, the cam will rotate counter-clockwise a short distance in section 1, open all the contacts and de-energize all components until the next time the dishwasher is operated.

As mentioned earlier, each set of contacts on the sequence switch control a different function in the dishwasher. The *white* connector plug contains the low voltage DC wiring. Two wires supply +/- 14 VDC to operate the motor. The remaining wires use 5 VDC to provide feedback on the position of the cam to the electronic control. The molded "raises" on the cam open and close the 5 VDC contacts, enabling the control to determine the cam's current position. A black wire is connected to a terminal that provides a common for all 5 VDC contacts within the switch.

The *black* connector plug contains the 120 VAC circuits.

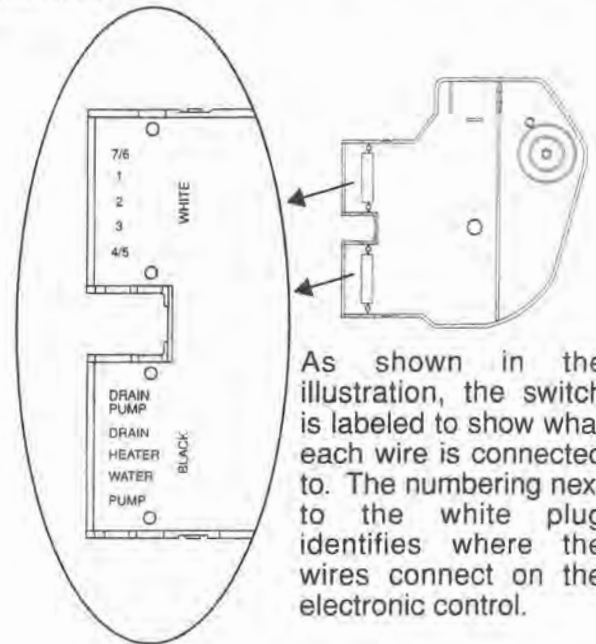

### Sequence Switch Removal

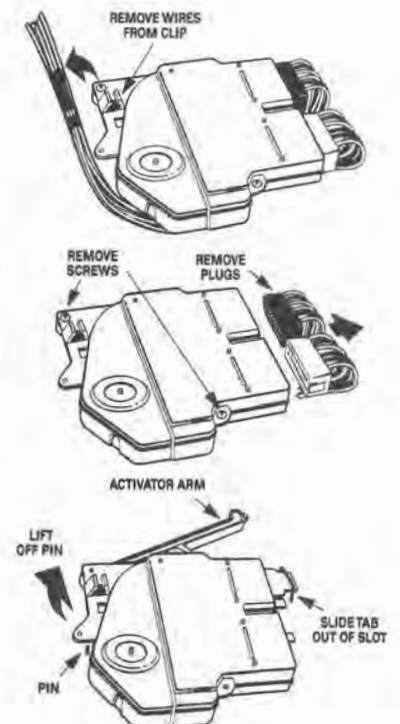



## Drying Cycle

There are two methods of drying the dishware at the end of the wash cycle; heated dry and energy saving natural dry. Both methods utilize convection air flow to aid in the drying process.

As shown in the illustration, convection air flow is created by the hot dishware drawing cool room air into the tub through the gap between the tub and the bottom of the inner door panel. This air helps to evaporate moisture as it is circulated through the tub. The air is exhausted back into the room through the upper door vent.

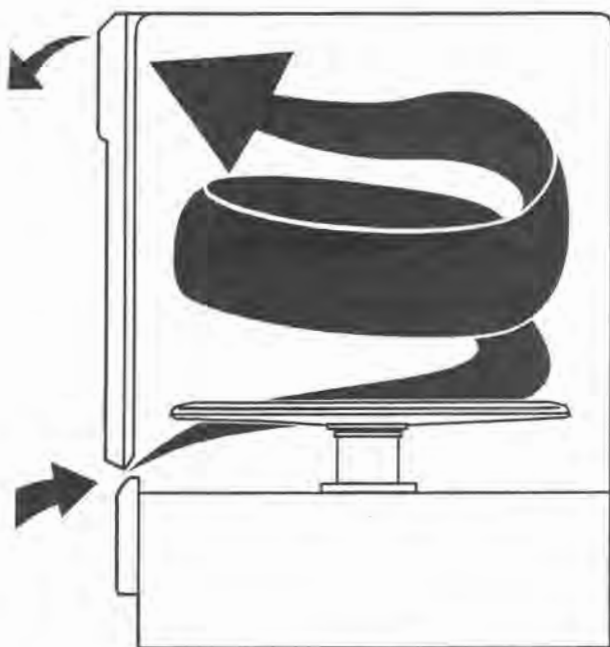

When HEATED DRY is selected, the heated dry LED will be lit and the heating element will be on during the dry portion of the cycle. This cycle will add 30 minutes to the total cycle time. This option may be changed by pressing the HEATED DRY pad any time after the wash cycle has started. If changed during the wet portion of the cycle, 30 minutes of dry time is either added or subtracted, as appropriate, from the remaining cycle time. If changed from ON to OFF during the dry portion of the cycle, the panel blanks and the CLEAN LED will be turned on. The HEATED DRY option will not operate on the RINSE and HOLD cycle.

**NOTE:** After a power failure, the electronic control will automatically default to HEATED DRY "ON".

Turbidity sensor models use the tub thermistor to monitor the temperature inside the dishwasher throughout the entire dry cycle. If the inside tub temperature exceeds 170°F, the electronic control turns the heater off.

## Heating Element



All "Z" model dishwashers contain a 500 watt Calrod® heating element. The element consists of a tungsten wire packed in magnesium oxide and surrounded by a coated stainless steel sheath. It has a resistance of approximately 29 ohms. The element can be utilized for heating the water during the wash cycle and for heating the air during the dry cycle.

Depending on the model, the heating element may be used in one of three ways during wash to help reach a 131°-135°F water temperature. This temperature is required to effectively dissolve animal fats and soils on dishware.

**Timed Heating** - all GSD2000 model series will automatically heat the water in prewash, main wash, and final rinse.

**Hi-Temp Wash Option** - turns the heating element on for an additional period of time during the main wash cycle.

**Auto Temperature Sensing** - turbidity sensor models measure the water temperature and turn on the heater when necessary.

These methods for heating the water still require a minimum water inlet temperature of 120° F. If the water temperature is too cold, the cycle will not be long enough for the heater to raise the water to the proper temperature.

## Notes on Drying





It is normal for steam to come through the active vent during the dry cycle and whenever water is being pumped from the tub.

Make certain the water inlet temperature is correct. Low water inlet temperature will prevent proper convection air movement and increase drying time substantially.

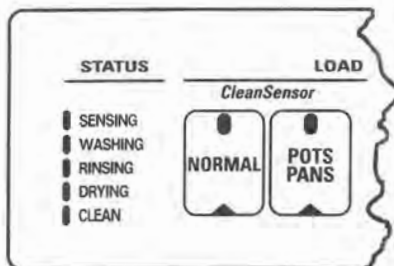
If the complaint is the dishes are not drying correctly, don't overlook the rinse agent. Rinse agent will improve the water sheeting action and improve drying performance.



# GE Profile Performance™



CUSTOMER CUES		
Status Lights	What It Means	What To Do
 <b>SENSING</b>  OFF	CLEANSENSOR Error.	If the sensing light does not come on during the NORMAL or POTS PANS cycles, the CLEANSENSOR is not working - call for service. The dishwasher will continue to work without the CLEANSENSOR. NOTE: This light will not stay on the entire cycle.
 <b>WASHING</b>  FLASHING	STAR/RESET pad has been pressed	Allow the dishwasher to drain and reset before selecting a new cycle.
 <b>RINSING</b>  FLASHING + BEEPING SOUND	Control Error	Press the START/RESET pad to turn off the beeper - the RINSING light will continue to flash. If this condition continues, call for service.
 <b>DRYING</b>  FLASHING + BEEPING SOUND	Control Error	Press the START/RESET pad to turn off the beeper - the dishwasher will attempt to reset. Restart the wash cycle. If this error continues, call for service.

# GE Profile™



CUSTOMER CUES		
Status Lights	What It Means	What To Do
 <b>START/RESET</b>	This is normal. The START/RESET pad has been pressed.	Allow the dishwasher to drain and reset before you start a new wash cycle.
 <b>CLEAN</b>  FLASHING + BEEPING SOUND	Control Error	Press the START/RESET pad to turn off the beeper. If the CLEAN light continues to flash, call for service.
 <b>NORMAL</b>  FLASHING + BEEPING SOUND	Control Error	Press the START/RESET pad to turn off the beeper - the dishwasher will attempt to reset. Restart the wash cycle. If this error continues, call for service.

Customer Fault Cues

# F1 Test Cycles

GE Profile Performance™ (Turbidity Sensor)

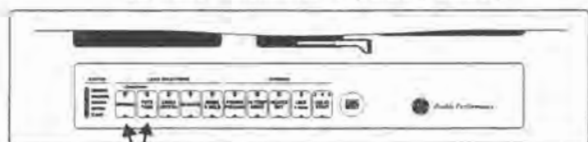

F1 Test Pads

GE Profile™ (Non-Sensor)

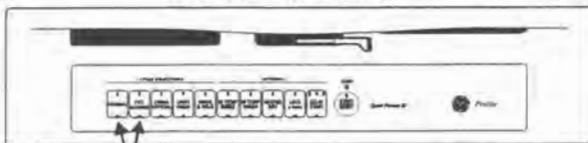

F1 Test Pads

## F1 TEST CYCLE SET UP

1. Close detergent cup and latch door.
2. Press POTS & PANS and NORMAL WASH keypads at the same time and hold for one second. It will then step through the test.

\* If the keypad is pressed except HEATED DRY, it will beep and the control will advance to next step.

\* If POTS & PANS and NORMAL WASH keypads are pressed at the same time for .5 seconds, control will exit test cycle, pump out any water, and return to normal operation.

\* Pump will come on in step 4 and stay on until step 13 for models WITHOUT auxiliary pump. For models WITH auxiliary pump, pump will come on in step 4 and stay on until step 11.

\* Use clamp on amp meter to check current flow in heating coil.

## FREEZE CAPABILITY

The FREEZE CAPABILITY shall allow the repair technician to pause only the F1 test cycle. Pressing the HEATED DRY keypad shall cause the control to pause on the current test step and the NORMAL WASH LED to illuminate. After the control is paused, pressing any keypad will cause the F1 test cycle to resume where it was when the pause was initiated, and the NORMAL WASH LED will be turned OFF. If the F1 test cycle is paused in a step with the heater ON, then the control will turn the heater OFF after one (1) minute into the FREEZE CAPABILITY pause.

GE Profile Performance™ (Turbidity Sensor)  
F-1 TEST LED DISPLAY RESULTS

LED Display	Explanation	Potential Problem Fault
SENSING	The SENSING LED will flash when control is receiving incorrect signal from turbidity sensor	1. Connectors are not plugged in or terminal is not seated properly 2. Replace turbidity sensor 3. Replace Control
HEATED DRY	The HEATED DRY LED will flash when control is reading the tub temperature sensor as open or short circuit	1. Broken wire or terminal is not seated 2. Connectors are not plugged in 3. Temperature sensor is shorted or open 4. Replace control
DRYING	The DRYING LED will flash and control will beep when the sequence switch is not reaching its target position within 30 seconds	1. Check connections between sequence switch and control 2. Replace sequence switch 3. Replace control
LOCK	The LOCK LED will flash when the EPROM inside the control is damaged	1. Replace control
RINSING	The RINSING LED will flash and control will beep when model selection connector is missing	1. Install correct model selector jumper 2. Check jumper for wires seated or jumper missing, replace with correct jumper

GE Profile™ (Non-Sensor)

F-1 TEST LED DISPLAY RESULTS

LED Display	Explanation	Potential Problem Fault
NORMAL	The NORMAL LED will flash and control will beep when the sequence switch is not reaching its target position within 30 seconds.	1. Check connections between the sequence switch and control 2. Replace sequence switch 3. Replace control
CLEAN	The CLEAN LED will flash and control will beep when model selection connector is missing.	Install correct model plug

F-1 TEST CYCLE MATRIX  
Models WITH Auxiliary Pump

Step	Time (Sec's)	LED Display	Definition
1.		Sensing / Washing	Binary Code (Factory Use Only)
2.	5	All LEDs	
3.	30	Drying / Clean	Trips detergent cup Water valve on for 30 seconds
4.	47	Rinsing	Water valve on for 47 sec. Main pump on Close active vent
5.	60	Rinsing / Clean	Main pump and heater on for 60 sec.
6.	10	Rinsing / Drying	Remove water with main pump and turn drain solenoid on for 10 sec.
7.	50	Rinsing / Drying / Clean	Main pump on for 50 sec.
8.	Less than 10	Washing	Advance sequence switch to trip rinse agent Check turbidity sensor, tub temperature, memory. Errors cause beep and all LED's on
9.	30	Washing / Clean	Water valve on for 30 sec.
10.	47	Washing / Drying	Water valve and main pump on for 47 sec.
11.	3600 (60 min)	Washing / Drying / Clean	Main pump and heater on for 60 sec.
12.	60	Washing / Rinsing	Open vent, turn on auxiliary pump for 60 sec.
13.		Washing / Rinsing / Drying / Clean	Home Sequence Switch End Test

F-1 TEST CYCLE MATRIX  
Models WITHOUT Auxiliary Pump

Step	Time (Sec's)	LED Display	Definition
1.		Sensing / Washing	Binary Code (Factory Use Only)
2.	5	All LEDs	
3.	30	Drying / Clean	Trips detergent cup Water valve on for 30 seconds
4.	47	Rinsing	Water valve on for 47 sec. Main pump on Close active vent
5.	60	Rinsing / Clean	Main pump and heater on for 60 sec.
6.	10	Rinsing / Drying	Remove water with main pump and turn drain solenoid on for 10 sec.
7.	50	Rinsing / Drying / Clean	Main pump on for 50 sec.
8.	Less than 10	Washing	Advance sequence switch to trip rinse agent Check turbidity sensor, tub temperature, memory. Errors cause beep and all LED's on
9.	30	Washing / Clean	Water valve on for 30 sec.
10.	47	Washing / Drying / Clean	Water valve and main pump on for 47 sec.
11.	3600 (60 min)	Washing / Drying	Main pump and heater on for 60 sec.
12.	10	Washing / Rinsing	Open vent, turn on main pump, drain solenoid on for 10 sec.
13.	50	Washing/Rinsing/Clean	Main pump on for 50 sec.
14.		Washing / Rinsing / Drying / Clean	Home Sequence Switch End Test

### SEQUENCE SWITCH WHITE PLUG VOLTAGES

PIN	VDC	
4	14	DRIVE MOTOR **
5	14	DRIVE MOTOR **
17	5	5 VDC COMMON
16	5	
13	5	
10	5	
7	5	

\*\* Only powered when the sequence switch is rotating. DC voltage may be + or - depending on the direction of rotation.

### MODEL SELECTOR CONNECTOR CHART

MODELS	WIRE COLOR	TERMINAL POSITION
GSD4900'S	YELLOW	2 & 5
GSD4600'S	WHITE	1 & 6
GSD4310, 4320, 4330	YELLOW	2 & 5
GSD4315, 4325, 4335	BLUE	3 & 5
GSD4000'S	WHITE	1 & 6

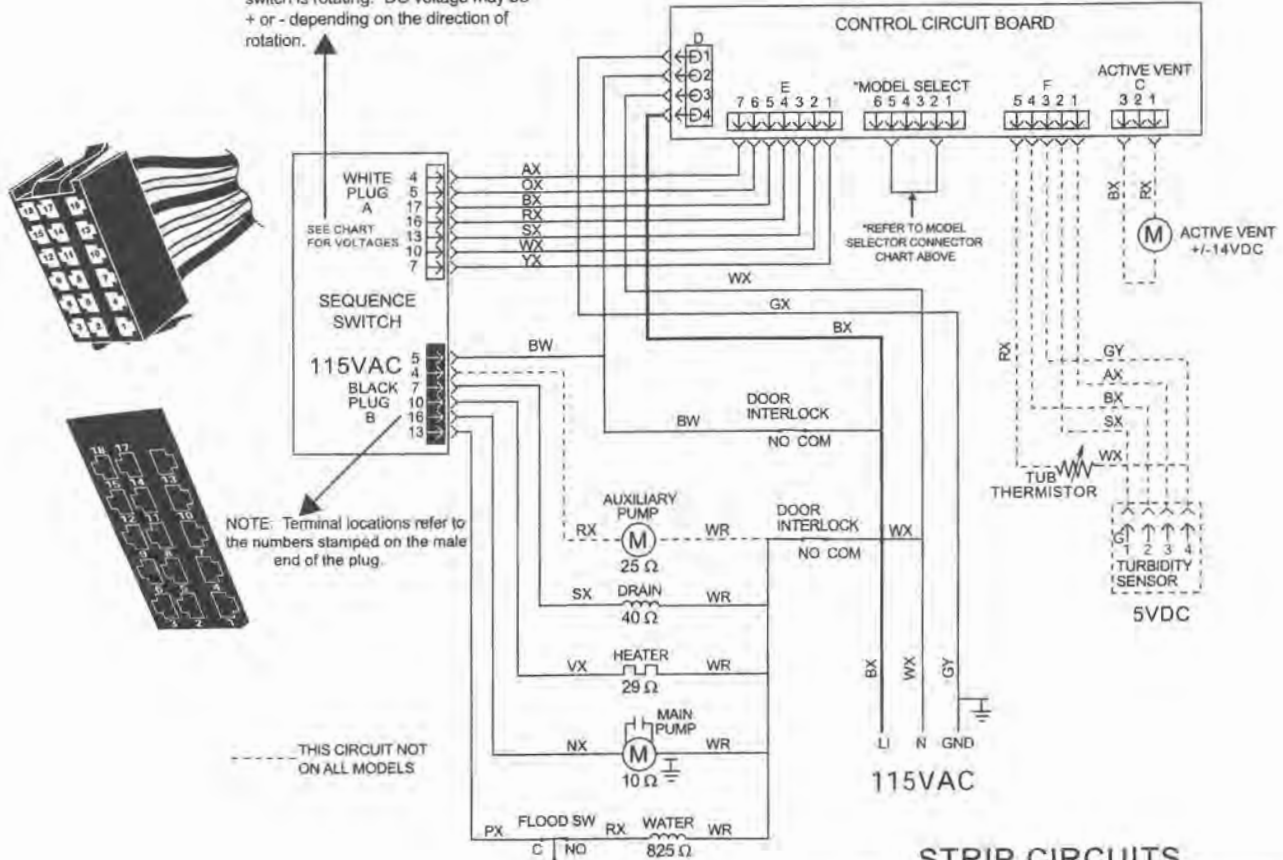

NOTE: Terminal locations refer to the numbers stamped on the male end of the plug.

--- THIS CIRCUIT NOT ON ALL MODELS

### SEQUENCE SWITCH LEAD COLORS AND TERMINAL LOCATIONS

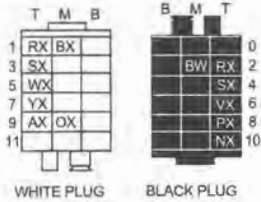

COLOR CODE			
LETTERS	COLOR	LETTERS	COLOR
AX	LT. BLUE	RX	RED GRAY
BX	BLACK	SX	TAN
CX	BROWN	TX	PURPLE
NX	DK. BLUE	VX	WHITE
OX	ORANGE	WX	YELLOW
PX	PINK	YX	

THE "X" INDICATES ONE SOLID COLOR - NO TRACER. WIRES WITH TRACER SHOW BOTH COLORS. EXAMPLE - WR IS WHITE WITH RED TRACER.

### STRIP CIRCUITS

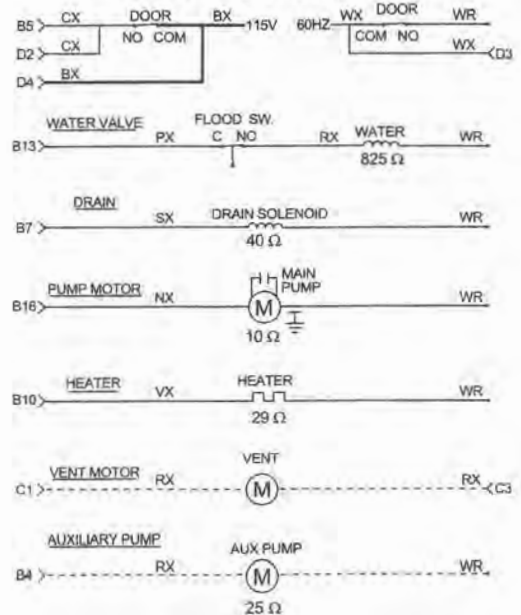

# Troubleshooting

## The Drying Light *Flashing* on Profile Performance™ Models or The Normal Light *Flashing* on Profile™ Models

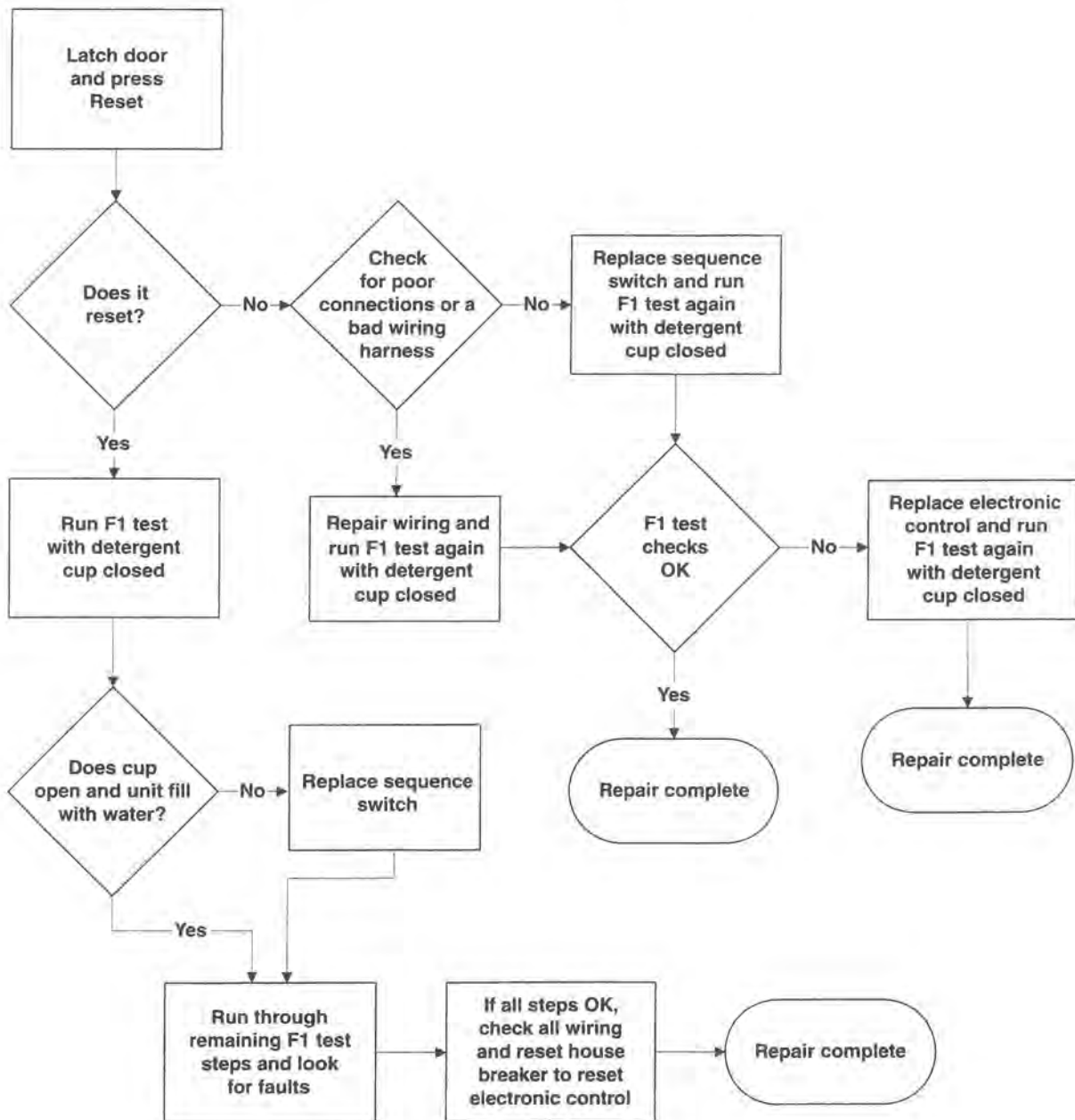



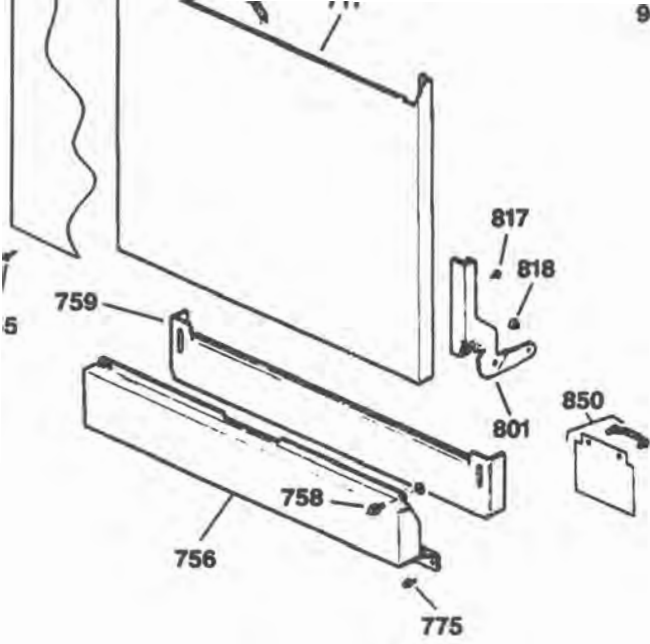

**NOTE:** Some parts not used on all  
GSD4920 Shown

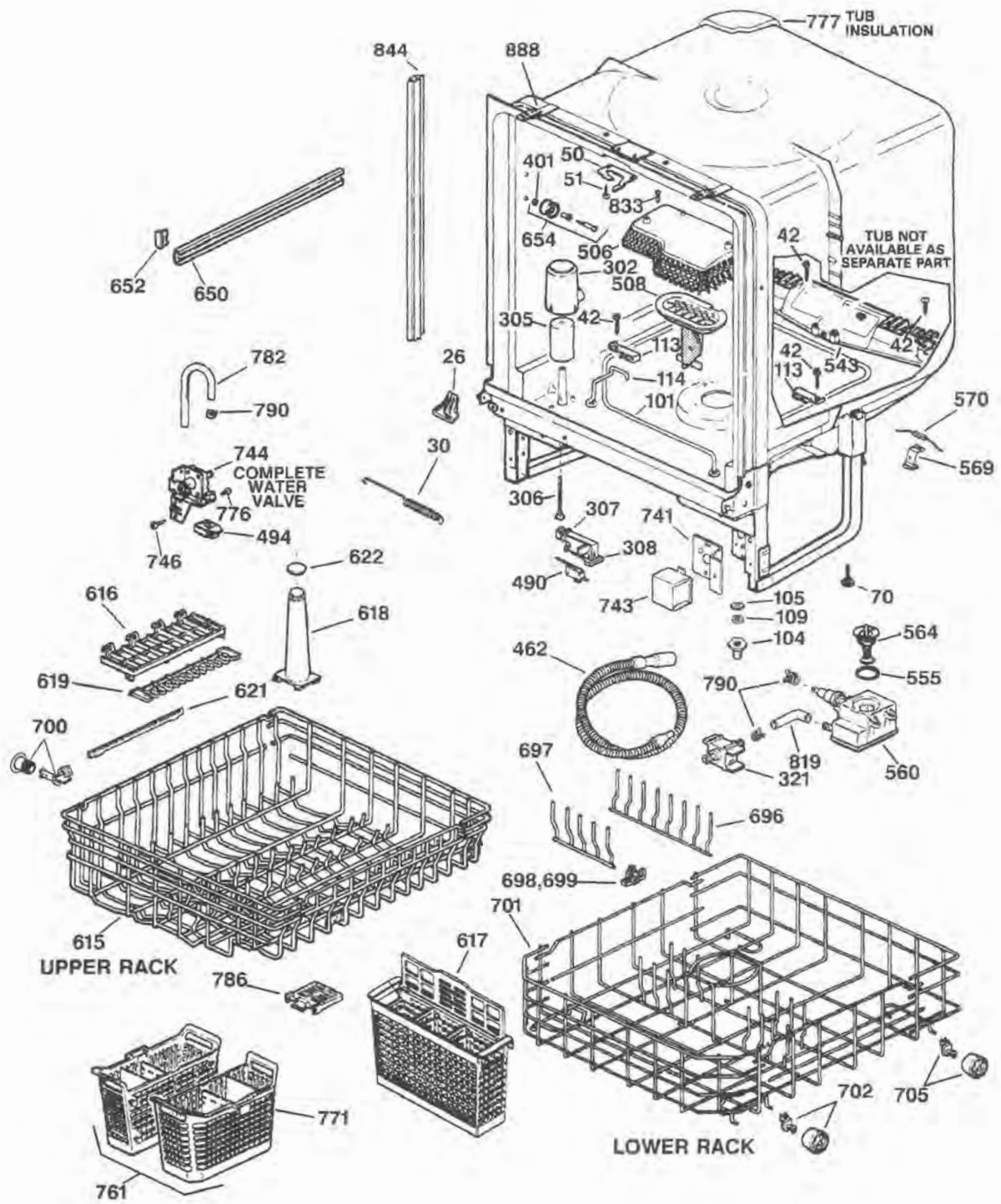

**NOTE:** Some parts not used on all models

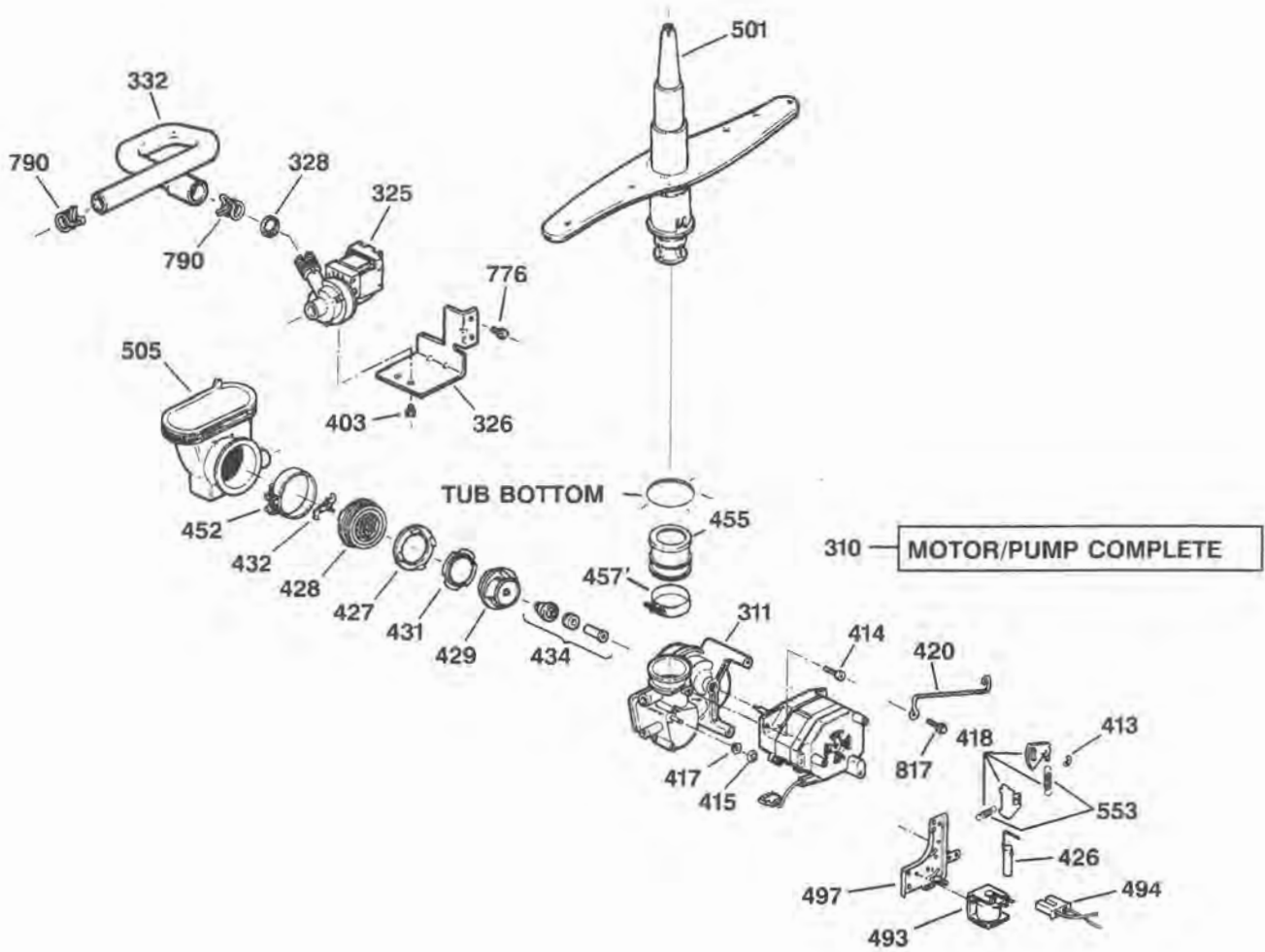

**NOTE:** Some parts not used on all models

## Quick Reference Parts\*

Reference #	Part #	Description
1	31-3077	Mini Manual - Profile Performance™
1	31-3078	Mini Manual - Profile™
1	31-3089	Mini Manual - GSD3600 series
1	31-3086	Mini Manual - GSD3200 series
1	31-3083	Mini Manual - GSD2000 series
1	31-30130	Installation Instructions
1	49-5845	Owners Manual - Profile Performance™
1	49-5847	Owners Manual - Profile™ GSD4300 series
1	49-5846	Owners Manual - Profile™ GSD4000 series
1	49-5819	Owners Manual - GSD3600 series
1	49-5817	Owners Manual - GSD2000 series
26	WD08X227	RH Tub Corner Baffle
26	WD08X228	LH Tub Corner Baffle
30	WD02X10001	Yellow Door Spring (26.5 lbs)
30	WD02X0551	Red Door Spring (21.5 lbs)
30	WD02X10003	White Door Spring (20.0 lbs)
30	WD02X10023	Orange Door Spring (18.0 lbs)
101	WD05X0070	Heating Element Assembly
310	WD26X10004	Induction Motor/Pump Assembly
310	WD26X10003	Shaded Pole Motor/Pump Assembly
321	WD21X0769	Turbidity Sensor
325	WD19X0059	Auxiliary Drain Pump
462	WD24X0219	Drain Hose
490	WD21X0479	Flood Switch
493	WD21X710	Drain Solenoid
501	WD22X10007	Spray Arm Assembly - GSD4000 series
501	WD22X10006	Spray Arm Assembly - GSD3000 series
501	WD22X154	Spray Arm Assembly - GSD2000 series
560	WD22X0150	Collection Chamber and Check Valve

\*NOTE: Some parts not used on all models



## Quick Reference Parts\*

Reference #	Part #	Description
564	WD24X0220	Collection Chamber Piston and Nut
569	WD01X10021	Thermistor Mounting Clip
570	WD21X10023	Thermistor
744	WD15X0096	Quiet Water Valve Assembly (1.25 gpm)
744	WD15X0093	Standard Water Valve Assembly (1.75 gpm)
801	WD14X10001	LH Arm Hinge (Complete)
801	WD14X10002	RH Arm Hinge (Complete)
802	WD13X0069	Latch Assembly
803	WD06X0245	Interlock Switch Assembly
811	WD12X0398	Rinse Aid Injector Assembly
822	WD16X0297	Detergent Cup Cover
823	WD16X0313	Detergent Cup Shaft/Handle
828	WD16X10002	Detergent Cup Latch
829	WD12X0409	Rinse Aid Dispenser Cap
837	WD03X0749	Sequence Switch Lever Spring
838	WD03X0776	Vent Spring
840	WD03X0764	Detergent Trip Lever Spring
848	WD21X10025	Control Wire Harness
861	WD12X10019	Sequence Switch Lever
904	WD21X10018	Sequence Switch
	WD21X10020	Timer - GS3600 series
	WD21X10013	Timer - GSD2000,3200 series
905	WD21X10004	Profile Performance™ Control Assembly
905	WD21X10003	Profile™ Control Assembly
905	WD21X10006	Profile™ Control (GSD4315, 4325, 4335)
918	WD21X10022	Vent Motor Assembly



**GE Profile Performance™ and GE Profile™ Built-In Models**

	Almond	Black	White	Stainless Steel
1/4" Custom Wood Panel with Trim	GPF425A	GPF425B	GPF425W	N/A
3/4" Custom Wood Panel - No Trim	GPF475	GPF475	GPF475	N/A
Color Replacement Panels	GPF400A	GPF400B	GPF400W	GPF400S
Trimless Door Panel	GPF600A	GPF600B	GPF600W	N/A
Trimless Access Panel	GPF700A	GPF700B	GPF700W	N/A

Available for:  
 GE Profile Performance™ models - GSD4900 Series and GSD4600 Series  
 GE Profile™ models - GSD4300 and GSD4000 Series

**GE, Hotpoint and RCA Built-In Models**

	Almond	Black	White
1/4" Custom Wood Panel with Trim	GPF325A	GPF325B	GPF325W
3/4" Custom Wood Panel - No Trim	GPF375	GPF375	GPF375
Color Replacement Panels	GPF300A	GPF300B	GPF300W
Trimless Door Panel	GPF500A	GPF500B	GPF500W
Trimless Access Panel	GPF700A	GPF700B	GPF700W

Available for:  
 GE models - GSD3800 Series, GSD3600 Series, GSD3400 Series, GSD3200 Series, GSD2200 Series, GSD2000 Series  
 Hotpoint models - HDA3400 Series, HDA3200 Series, HDA2200 Series, HDA2000 Series, HDA1000 Series  
 RCA models - PSD3400 Series, PSD3200 Series, PSD2200 Series, PSD1000 Series

**Wood Insert Cutout Dimensions**

Models/Kit	A	B	C	Panel Thickness
GSD4900/4600/ 4300/4000 Series GPF425 Kit	19-3/4"	23-9/16"	3-11/16"	1/4"
GSD4900/4600/ 4300/4000 Series GPF475 Kit	19-13/16"	23-5/8"	4-1/4** to 3-11/16***	3/4"
All Other Models GPF325 Kit	18-7/8"	23-9/16"	3-11/16"	1/4"
All Other Models GPF375 Kit	18-15/16"	23-5/8"	4-1/4** to 3-11/16***	3/4"

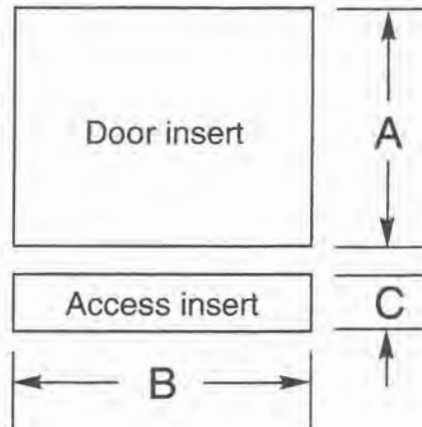

**NOTE:**  
 \* Bottom of panel must be notched 1-1/2" x 1/2" to clear access panel.  
 \*\* Adjustment required to match adjacent cabinet fronts due to leveling leg adjustment -4" nominal.

**GPS5AD** - Almond side panel

**GSP5WH** - White side panel

Side Panels for all GE models contain one panel and adjustable to kick for end cabinet installation of built-in model. Does not attach to dishwasher.

**GPF47BK** - Black 6" access panel kit

**GPF47WH** - White 6" access panel kit

**GPF53** - Dishwasher bracket for non-wood countertop installation

**GPF100** - Heavy spring kit for custom door panel weighing more than 4 lbs.

**GPF200** - Almond/Black/White side tub flange gasket kit

**What GE Will Not Cover:**

- Service trips to the home to teach the customer how to use the dishwasher.
- Improper installation.
- Replacement of house fuses or resetting of circuit breakers.
- Failure of the product if it is abused, misused, or used for other than the intended purpose or used commercially.
- Damage to the product caused by accident, fire, floods or acts of God.
- Incidental or consequential damage to personal property caused by possible defects with this appliance.
- Cleaning or servicing of the air gap device in the drain line.

## Warranty Information

Model #	1-Year	2-Year	2-Year	5-Year	10-Year	20-Year
GSD2000ZAD	✓				✓	
GSD2000ZWH	✓				✓	
GSD2020ZBB	✓				✓	
GSD2030ZWW	✓				✓	
GSD2210ZAA*	✓	✓			✓	
GSD2220ZBB*	✓	✓			✓	
GSD2230ZWW*	✓	✓			✓	
GSD3210ZAA	✓	✓			✓	
GSD3220ZBB	✓	✓			✓	
GSD3230ZWW	✓	✓			✓	
GSD3410ZAA	✓	✓			✓	
GSD3420ZBB	✓	✓			✓	
GSD3430ZWW	✓	✓			✓	
GSD3610ZAA*	✓	✓			✓	
GSD3620ZBB*	✓	✓			✓	
GSD3630ZWW*	✓	✓			✓	
GSD3810ZAA*	✓	✓			✓	
GSD3820ZBB*	✓	✓			✓	
GSD3830ZWW*	✓	✓			✓	
GSD4010ZAA	✓		✓	✓		✓
GSD4020ZBB	✓		✓	✓		✓
GSD4030ZWW	✓		✓	✓		✓
GSD4310ZAA	✓		✓	✓		✓
GSD4320ZBB	✓		✓	✓		✓
GSD4330ZWW	✓		✓	✓		✓
GSD4610ZAA	✓		✓	✓		✓
GSD4620ZBB	✓		✓	✓		✓
GSD4630ZWW	✓		✓	✓		✓
GSD4910ZAA	✓		✓	✓		✓
GSD4920ZBB	✓		✓	✓		✓
GSD4930ZWW	✓		✓	✓		✓
GSD4940ZSS	✓		✓	✓		✓
*Contract only	Any Part of The Dishwasher (Parts & Labor)	Any Part of the Water Distribution System (Parts Only)	Any Part of the Dishwasher (Parts Only)	Racks or Electronic Control Board (Parts Only)	PermaTuf® Tub and Door Liner (Parts & Labor)	PermaTuf® Tub and Door Liner (Parts & Labor)

**NOTE:** The Electronic Control Board warranty does not include the sequence switch

See the warranty information in the Owners Manual for additional details.

