



TECHNICAL SERVICE GUIDE

General Electric Side-by-Side Knob Control/Metal Liner Refrigerator



MODEL SERIES:

GSS20
GSS22
GSS25
ESS22
ESS25
HSS22
HSS25
SSS25





IMPORTANT SAFETY NOTICE

The information in this service guide is intended for use by individuals possessing adequate backgrounds of electrical, electronic, and mechanical experience. Any attempt to repair a major appliance may result in personal injury and property damage. The manufacturer or seller cannot be responsible for the interpretation of this information, nor can it assume any liability in connection with its use.

WARNING

To avoid personal injury, disconnect power before servicing this product. If electrical power is required for diagnosis or test purposes, disconnect the power immediately after performing the necessary checks.

RECONNECT ALL GROUNDING DEVICES

If grounding wires, screws, straps, clips, nuts, or washers used to complete a path to ground are removed for service, they must be returned to their original position and properly fastened.

GE Consumer Home Services Training
Technical Service Guide
Copyright © 2001

All rights reserved. This service guide may not be reproduced in whole or in part in any form without written permission from the General Electric Company.

Table of Contents

Introduction	2
Installation	3
Specifications	4
Nomenclature	5
Warranty Information	6
Operating Characteristics	7
General Locator Views	13
Mechanical Disassembly	15
Diagnostics	32
Component and Connector Locator Views	50
Schematics	54
Illustrated Parts Catalog	58

Introduction

2001 Energy SxS models are being introduced in response to the requirement for more energy-efficient refrigerators by mid year 2001, along with having feature and operation enhancements. The primary differences in this refrigeration system are the adaptive defrost system (see Pub. # 31-9062), control board, software, and control systems that operate independently in fresh food and freezer sections. The new high-efficiency control system has the ability to cycle components and adjust fan speeds as required to maintain temperature-setting ranges in freezer and fresh food sections. Feedback systems are digital inputs and relay outputs. Sensors (thermistors) are used to measure temperature with communications to a main PC board, which controls the unit components. The refrigerator has versions that have control knobs or touchpads (Profile models) to provide inputs to a microprocessor. The freezer/fresh food controls are temperature setpoint type and have settings of 0-9 with 9 being the coldest temperature possible. The new NO CLEAN condenser is serviceable from the rear and is designed to prevent the customer from having to clean the condenser in normal usage conditions.

Sealed system operation and compressor are functionally the same as previous models, with some minor changes.

The 20', 22', and 25' side-by-side models are the models affected. These models are available with through-the-door chilled water and ice dispenser, and built-in water filter feature. On models requiring icemaker, the newest electronic icemaker (see Pub. # 31-9063) has been or can be installed.

The freezer has adjustable shelves, slide-out Spillproof shelf, QuickSpace shelf, and deep door shelves, based on model. The fresh food section has a baking soda holder, fruit and vegetable drawer, drawer dividers, adjustable humidity drawer, and convertible meat drawer.

This new high-efficiency refrigerator is a combination of the most efficient refrigeration system and the most desirable customer features available.



Installation

ATTENTION INSTALLER: FOR A QUALITY INSTALLATION, FOLLOW THESE INSTRUCTIONS.

1

HEX-HEAD BOLTS (4)

- REMOVE AND DISCARD SKIDBOARDS and bolts used to hold skidboards.
- Use PADDED HAND TRUCK to protect refrigerator finish.

2

CARDBOARD PROTECTS DOOR EDGES

DO NOT OVER-TIGHTEN STRAP

MAKE SURE FRONT ROLLERS DO NOT REST ON TRUCK

TRUCK FROM SIDE ONLY

- LEAVE TAPE ON DOORS until refrigerator is in its final location.

3

ROLLER ADJUSTMENT

- ADJUST FRONT ROLLERS so that refrigerator is solid and doors close easily.
- MAKE SURE DOORS ARE EVEN AT TOP. Check gasket seal.

4

9 IS COLDEST
0 IS OFF

FREEZER

FRESH FOOD

- SET BOTH CONTROLS TO "5".
- SET ICEMAKER TO OFF until water line is connected.

5

- IMPORTANT: IMMEDIATELY REMOVE ALL CLEAR PROTECTIVE TAPE FROM TRIM.
- TO REMOVE TAPE RESIDUE AND HANDPRINTS, USE APPLIANCE POLISH.
- REMOVE ALL TAPE AND OTHER PACKAGING MATERIAL FROM INSIDE REFRIGERATOR. DO NOT REMOVE SERIAL PLATE.

IF NECESSARY TO REMOVE DOORS, REMOVE ALL HINGES. FOR DISPENSER MODELS:

TUBING CLIP

COLLAR

PRESS THE WHITE COLLAR AS YOU PULL OUT THE TUBING.

- At lower left hinge, remove tubing from the clip.
- Disconnect the water line.

WHEN INSTALLING DOORS...

HINGE COVER

WIRING CONNECTORS

5/8" - 3/4"

- Push tubing into connector (5/8" to 3/4") to prevent leakage.
- At upper hinges, disconnect wiring connectors.
- Remove both hinges with each door to prevent damage to tubing or wiring.

TO REINSTALL DOORS...

ALIGN DOORS EVENLY AT TOP

FRESH FOOD HINGE ADJUSTMENT PIN

- Reinstall lower hinges and tighten hinge screws firmly.
- Place door on lower hinge pin and install upper hinges. Tighten upper hinge screws firmly.
- Align both doors evenly at top by adjusting pin on lower fresh food hinge.
- Reconnect wiring connectors and reinstall hinge covers.
- Reinstall tubing by pushing tubing into connector.
- Put tubing back into clip.

FRANÇAIS • ESPAÑOL

PREFERRED METHOD

MAKE SURE PROPER GROUND EXISTS BEFORE USE

TEMPORARY METHOD (Adapter plugs not permitted in Canada)

ENSURE PROPER GROUND AND FIRM CONNECTION BEFORE USE

IMPORTANT: PLEASE READ CAREFULLY FOR PERSONAL SAFETY, THIS APPLIANCE MUST BE PROPERLY GROUNDED.

The power cord of this appliance is equipped with a three-prong (grounding) plug that mates with a standard three-prong (grounding) wall receptacle to minimize the risk of electric shock hazard from this appliance. The customer should have the wall receptacle and circuit checked by a qualified electrician to make sure the receptacle is properly grounded.

Where a standard two-prong wall receptacle is encountered, it is the personal responsibility and obligation of the customer to have it replaced with a properly grounded three-prong wall receptacle.

DO NOT, UNDER ANY CIRCUMSTANCES, CUT OR REMOVE THE THIRD (GROUND) PRONG FROM THE POWER CORD.

USAGE SITUATIONS WHERE THE APPLIANCE'S POWER CORD WILL BE DISCONNECTED INFREQUENTLY

Because of potential safety hazards under certain conditions, we strongly recommend against the use of an adapter plug. However, if you still elect to use an adapter, where local codes permit, a TEMPORARY CONNECTION may be made to a properly grounded two-prong wall receptacle by the use of a UL listed adapter which is available at most hardware stores. The larger slot of the adapter must be aligned to provide proper polarity in the connection of the power cord.

CAUTION: Attaching the adapter ground terminal to the wall receptacle cover screw does not ground the appliance unless the cover screw is metal, and not insulated, and the wall receptacle is grounded through the house wiring. The customer should have the circuit checked by a qualified electrician to make sure the receptacle is properly grounded. When disconnecting the power cord from the adapter, always hold the adapter with one hand. If this is not done, the adapter ground terminal is very likely to break with repeated use. Should this happen, DO NOT USE the appliance until a proper ground has again been established.

USAGE SITUATIONS WHERE THE APPLIANCE'S POWER CORD WILL BE DISCONNECTED FREQUENTLY

Do not use an adapter plug in these situations because frequent disconnecting of the power cord places undue strain on the adapter and leads to eventual failure of the adapter ground terminal. The customer should have the two-prong wall receptacle replaced with a three-prong (grounding) receptacle by a qualified electrician before using the appliance.

197D3266P001 31-5087 9-00 JR

Specifications

DISCONNECT POWER CORD BEFORE SERVICING IMPORTANT-RECONNECT ALL GROUNDING DEVICES

All parts of this appliance capable of conducting electrical current are grounded. If grounding wires, screws, straps, clips, nuts or washers used to complete a path to ground are removed for service, they must be returned to their original position and properly fastened.

IMPORTANT SAFETY NOTICE

This information is intended for use by individuals possessing adequate backgrounds of electrical, electronic and mechanical experience. Any attempt to repair a major appliance may result in personal injury and property damage. The manufacturer or seller cannot be responsible for the interpretation of this information, nor can it assume any liability in connection with its use.

ELECTRICAL SPECIFICATIONS

Thermistor calibration: kilo-ohm resistance @ 0°F 62.79
 @ 37°F 24.48
 @ 77°F 10.00
 Defrost Control adaptive system
 Defrost Thermostat 140-110°F

ELECTRICAL RATING

Maximum Current Leakage 0.75 mA.
 Maximum Ground Path Resistance 0.14 Ohms
 Energy Consumption 58 KWH/mo.

NO LOAD PERFORMANCE

Control Position 5/5 and Ambient of 70°F -90°F
 Fresh Food, °F 34-41
 Frozen Food, °F -3 -3
 Run Time % @ 70 Ambient 46-58%
 Run Time % @ 70 Ambient 52-64%

REFRIGERATION SYSTEM

Refrigerant Charge (R134a) 4.25 ounces
 Compressor 1030 BTU/hr
 Minimum Compressor Capacity 23 inches
 Minimum Equalized Pressure
 @ 70°F 62 PSIG
 @ 90°F 54 PSIG

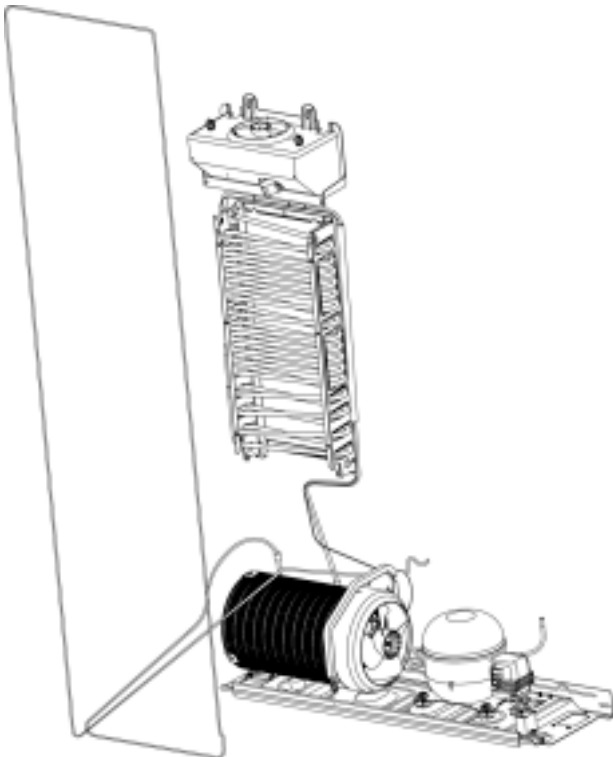

INSTALLATION

Clearance must be provided for air circulation

AT TOP 1"
 AT SIDES 0.13"
 AT REAR 1"

AIR FLOW

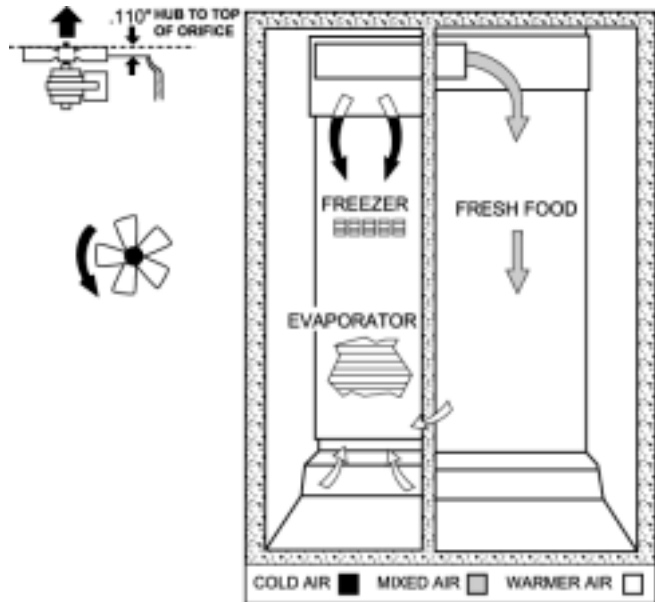

MODELS

ESS25XG	GSS25JF	GSS25KG
GSS25QF	GSS25SG	GSS25UF
GSS25VG	GSS25WG	GST25KG
HSS25IF	HST25IF	SSS25KF

REPLACEMENT PARTS

Board Asm Encoder	wr55x10040
PTCR	wr07x10033
Overload	wr08x10026
Capacitor	wr062x0080
Heater and Bracket Asm	wr51x10030
Motor DC Cond Fan	wr60x10053
Motor DC Evap Fan	wr60x10043
Board Asm Main Control	wr55x10037
Compressor Replacement Kit	wr87x10041
Sensor Temperature	wr50x10027

Nomenclature

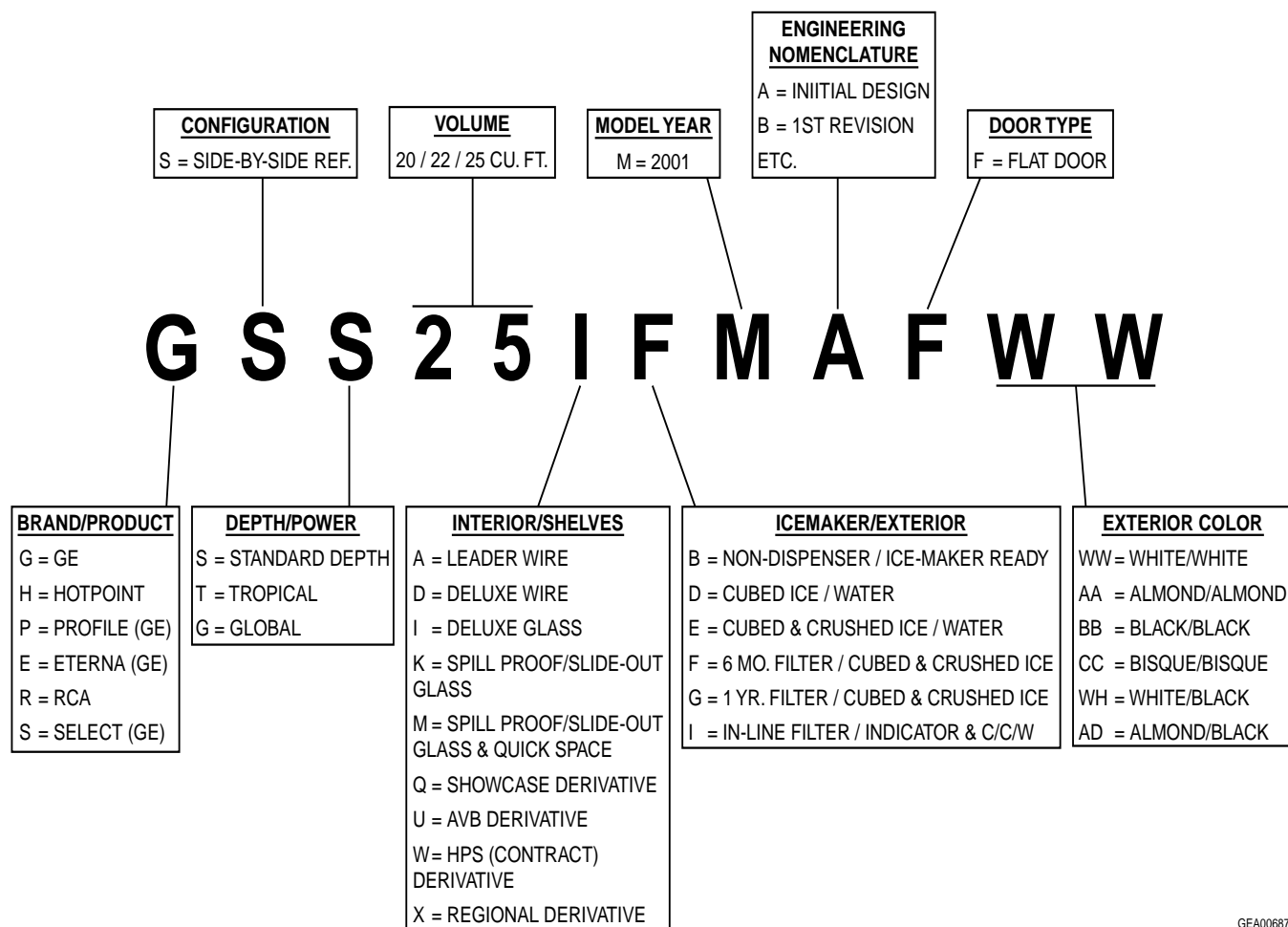

GEA00687

Note: Mini Manual/Tech Data Sheet is located in a plastic bag in the control console.

Warranty Information

Sales slip or cancelled check is required as proof of original purchase date to obtain service under warranty. Note: Water filter cartridge warranty is 30 days.

All warranty service is provided by our Factory Service Centers or an authorized Customer Care® technician.

For The Period Of:	GE Will Replace:
One Year <i>From the date of the original purchase</i>	Any part of the refrigerator which fails due to a defect in materials or workmanship. During this full one-year warranty , GE will also provide, free of charge , all labor and in-home service to replace the defective part.
Five Years <i>From the date of the original purchase</i>	Any part of the sealed refrigerating system (the compressor, condenser, evaporator, and all connecting tubing) which fails due to a defect in materials or workmanship. During this five-year warranty , GE will also provide, free of charge , all labor and in-home service to replace the defective part in the sealed refrigerating system.
Lifetime <i>From the date of the original purchase</i>	Any see-through pan or drawer furnished with the refrigerator if the pan or drawer breaks during normal household use. Drawer covers are not included. During this limited lifetime warranty , you will be responsible for any labor or in-home service costs.

What GE Will Not Cover:

- Service trips to your home to teach you how to use the product.
- Improper installation.
- Failure of the product if it is abused or used for other than the intended purpose or used commercially.
- Loss of food due to spoilage.
- Replacement of house fuses or resetting of circuit breakers.
- Replacement of the water filter cartridge due to water pressure that is outside the specified operating range or due to excessive sediment in the water supply.
- Replacement of water filter cartridge after its expected useful life, 30 days.
- Damage to the product caused by accident, fire, floods, or acts of God.
- Incidental or consequential damage caused by possible defects with this appliance.

This warranty is extended to the original purchaser and any succeeding owner for products purchased for home use within the USA. In Alaska, the warranty excludes the cost of shipping or service calls to your home.

Some states do not allow the exclusion or limitation of incidental or consequential damages. This warranty gives you specific legal rights, and you may also have other rights which vary from state to state. To know what your legal rights are, consult your local or state consumer affairs office or your state's Attorney General.

Warrantor: General Electric Company, Louisville, KY 40225

Operating Characteristics

Table of Contents

Normal Operating Characteristics That Are Different from Previous Models ..	8
Abnormal Operating Characteristics (Incorrect Operation)	8
Adaptive Defrost	8
Cooling Operation (Adaptive Defrost)	8
Pre-Chill Operation (Adaptive Defrost)	8
Defrost Heater Operation (Adaptive Defrost)	9
Dwell Period (Adaptive Defrost)	9
Post Dwell (Adaptive Defrost)	9
Liner Protection Mode	9
Dispensing Functions	9
Dispenser Light	9
Dispenser Lock	10
Filters	10
Hinge System and Door Closure	10
Airflow (Cabinet Interior)	11
“Jelly Roll” Condenser	11
Main Control Board	12

Normal Operating Characteristics That Are Different from Previous Models

- Icemaker auger rotates clockwise.
- Evaporator fan running, without compressor or condenser fan.
- Post Dwell (Adaptive Defrost), compressor, and condenser fan on with evaporator fan off after defrost cycle.
- Liner Protection Mode, fan comes on when the doors are open for 3 minutes.
- Evaporator fan and compressor can run continuously for 2 hours (Adaptive Defrost).
- Different sound levels can be heard when the fan changes speed.
- Response time for drastic temperature change is 2 to 10 minutes. The main control board will only respond to 8 degrees (Fahrenheit) of temperature change per minute as determined by resistance of sensor.

Abnormal Operating Characteristics (Incorrect Operation)

- Evaporator fan on, compressor off, and damper shut (except liner protection mode).
- Rapid fan speed changes, fan takes at least 1 minute to change speeds.
- Compressor running without the condenser fan. The compressor and condenser fan should always run at the same time.

Adaptive Defrost

Adaptive Defrost can be described as a defrost system that adapts to a refrigerator's surrounding environment and household usage.

Unlike conventional defrost systems that use electromechanical timers with a fixed defrost cycle time, Adaptive Defrost utilizes an intelligent, electronic control to determine when the defrost cycle is necessary. In order to accomplish the correct defrost cycle time, the main control board monitors the following refrigerator operations:

- Length of time the refrigerator doors were open since the last defrost cycle.

- Length of time the compressor has run since the last defrost cycle.
- Amount of time the defrost heaters were on in the last defrost cycle.

Adaptive Defrost is divided into 5 separate cycles. Those operations are:

- Cooling Operation
- Pre-Chill Operation
- Defrost Heater Operation
- Dwell Period
- Post Dwell

(See Pub. #31-9062 for more information on Adaptive Defrost.)

Cooling Operation (Adaptive Defrost)

During the cooling operation, the main control board monitors door opening (fresh food and freezer doors) and compressor run times. The board counts the time the doors are open. It reduces the length between defrosts by 255 seconds (multiplication factor) for each second that each door is open. If both doors are open, it reduces it by twice the amount. The multiplication factor reduces compressor run time. If the doors are not opened, the compressor will run up to 60 hours between defrosts. If the doors are opened frequently and/or for long periods of time, the compressor run time between defrosts will be reduced to as little as 8 hours.

Pre-Chill Operation (Adaptive Defrost)

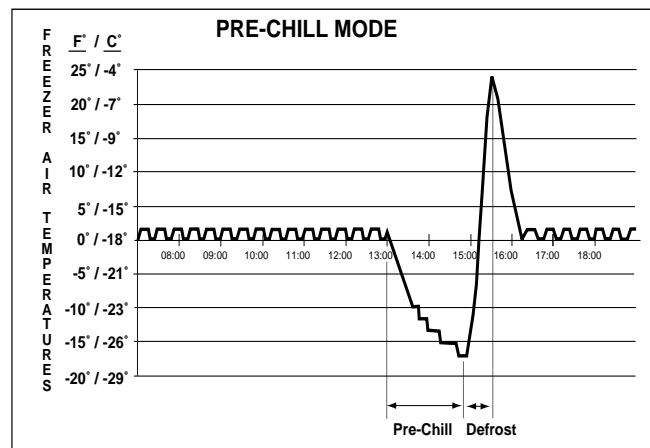

When the main control board determines that defrost is necessary, it will force the refrigerator

into a continuous cool mode (pre-chill). During pre-chill, the freezer temperature may be driven below the set point. However, the fresh food temperature will be regulated by the damper. Pre-chill will last for 2 hours. These models do not have a defrost holdoff.

Defrost Heater Operation (Adaptive Defrost)

After 2 hours of pre-chill operation, the main control board turns off the compressor, condenser fan, and evaporator fan.

During defrost operation, the main control board monitors the evaporator temperature using evaporator thermistor inputs. The thermistor will terminate defrost heater operation in less than 45 minutes. Typical defrost time is 20-30 minutes. Maximum defrost cycle is 45 minutes with heater on, 5 minutes in dwell.

The defrost system is protected by a defrost safety thermostat (switch). The thermostat opens when the evaporator temperature raises to 140° F and closes when the evaporator temperature lowers to 110° F.

Dwell Period (Adaptive Defrost)

After defrost heater operation has been terminated by the main control board, a 5-minute dwell period occurs. During this period, the compressor, condenser fan, and the evaporator fan remain off. The remaining frost melting from the evaporator will continue to drip and drain so that prior to the cooling operation, the evaporator will be totally clear of any moisture. After the 5-minute dwell period, the unit goes into post dwell.

Post Dwell (Adaptive Defrost)

The post dwell period is designed to cool the evaporator before circulating air within the refrigerator. This prevents any residual heat on the evaporator from being distributed in the freezer. During this period, the compressor is on and the condenser fan is on, but the evaporator fan is off, and the damper is closed. Post dwell lasts 10 minutes on these models.

Liner Protection Mode

The liner protection mode will activate if either of the doors have been open for 3 minutes. This mode will start the evaporator fan and close the damper.

This mode is controlled by 2 timers. Timer #1 monitors door-open time. A 3-minute door-open count begins when the door is opened. If 3 minutes elapse before the door is closed, the liner protection mode will become active. Once the door is closed, timer #1 resets and liner protection mode goes into standby. In standby, normal fan and damper operations resume and timer #2 begins a 3-minute door-closed count. If 3 minutes elapse without a door opening, liner protection mode will completely deactivate. If a door is opened within the timer #2 door-closed count, the remaining time in the door-closed count will be deducted from the timer #1 door-open count.

Dispensing Functions

The water, crushed ice, and cubed ice functions are controlled by the main control board. To select a function, press the appropriate pad on the dispenser. The LED will light to identify the selection.

To dispense the selected item, depress the dispenser cradle located in the dispenser recess. The solenoid and linkage assembly will open the ice chute door to dispense the ice. If cubed ice is selected, the crushed ice bypass solenoid will allow cubed ice to bypass the ice crusher. The ice chute door must remain open for 5 second after dispensing ceases. After this 5 second delay, the solenoid and linkage assembly will shut the ice chute door.

The dispenser light will come on automatically when the dispenser cradle is depressed and will fade out 5 seconds after it is released.

Dispenser Light

The LIGHT pad turns the dispenser light on and off. When the light is turned off, it will fade out. The dispenser light will come on automatically when the dispenser cradle is depressed and will fade out 5 seconds after it is released. The LIGHT pad will not turn off the light during dispense.

Dispenser Lock

When the dispenser system is locked, no dispenser command will be accepted. This includes the dispenser cradle and will prevent accidental dispensing that may be caused by children or pets. If a pad is pressed with the system locked, it will be acknowledged with 3 pulses of the LOCK LED accompanied by an audible tone.

To lock or unlock communication between the dispenser and main control board, press the LOCK pad and hold it for 3 seconds. The LOCK LED will flash while the LOCK pad is pressed. When the communication is locked, the LOCK LED will be illuminated.

The status of other functions selected prior to the initiation of the lock feature will be displayed. If the lock is engaged while a mode is active, the LED will remain on until that mode times out.

If the lock is engaged when the filter timer expires, the LED will come on but cannot be reset until the lock is turned off.

The lock feature will be restored in the event of a power disruption.

Filters

Some models are equipped with a water filter located in the upper right-hand corner of the fresh food compartment. The filter is designed to be used for up to 8 hours of open valve time or 1 year of calendar time.

When 90% of filter time (dependant on model) has elapsed (open valve time or calendar time, whichever comes first), the main control board will illuminate the filter reminder LED (amber). When 100% of the filter time has elapsed, the main control board will illuminate the filter reminder LED (red).

Hinge System and Door Closure

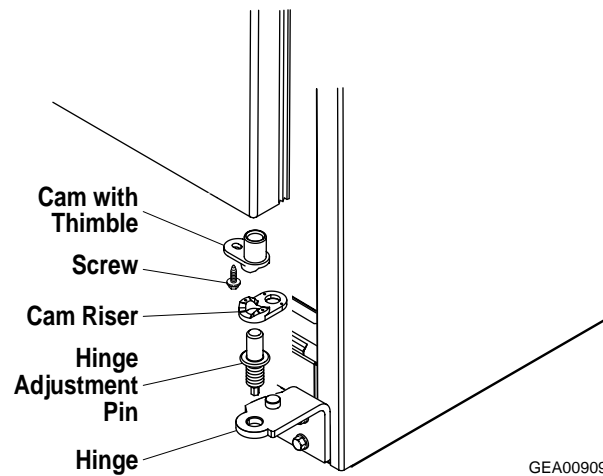

The hinge brackets are not adjustable on the cabinet. The fresh food door can be adjusted up and down by using the hinge adjustment pin (located on the fresh food lower door hinge).

The fresh food and freezer lower door hinges are equipped with replaceable cam risers. The cam risers assist in door closure. If the fresh food door is adjusted too high, cam riser will not be engaged, and the fresh food door will not close properly.

IMPORTANT: The refrigerator rollers must be adjusted correctly for proper door closure. When the rollers are adjusted correctly, the door should close easily when open approximately 45 degrees (halfway)

Airflow (Cabinet Interior)

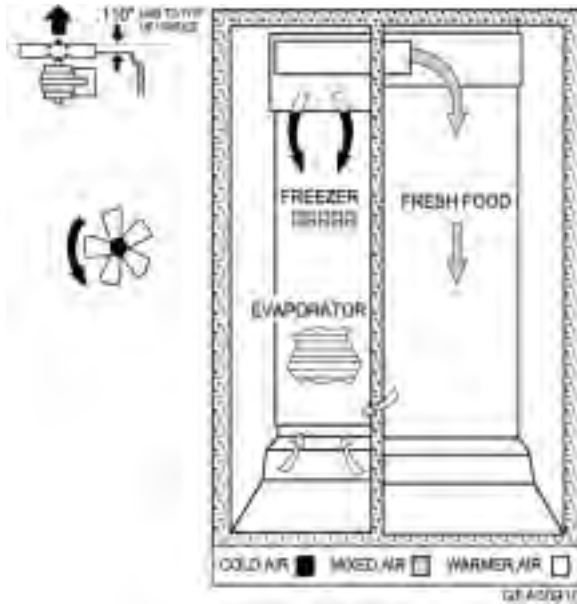

The freezer compartment is designed so that when the evaporator fan is operating, air is drawn into the bottom of the air tunnel and through the evaporator. The cold air is then pushed out into the top of the freezer.

The fresh food compartment receives chilled air via an electronic damper positioned at the top, rear of the refrigerator between the freezer compartment and the fresh food compartment. The damper is controlled by the main control board and when open, allows chilled air from the freezer air tunnel to move into the fresh food compartment.

Air returns from the fresh food compartment to the freezer compartment via a vent located to the left of the FRESH PRODUCE drawer.

“Jelly Roll” Condenser

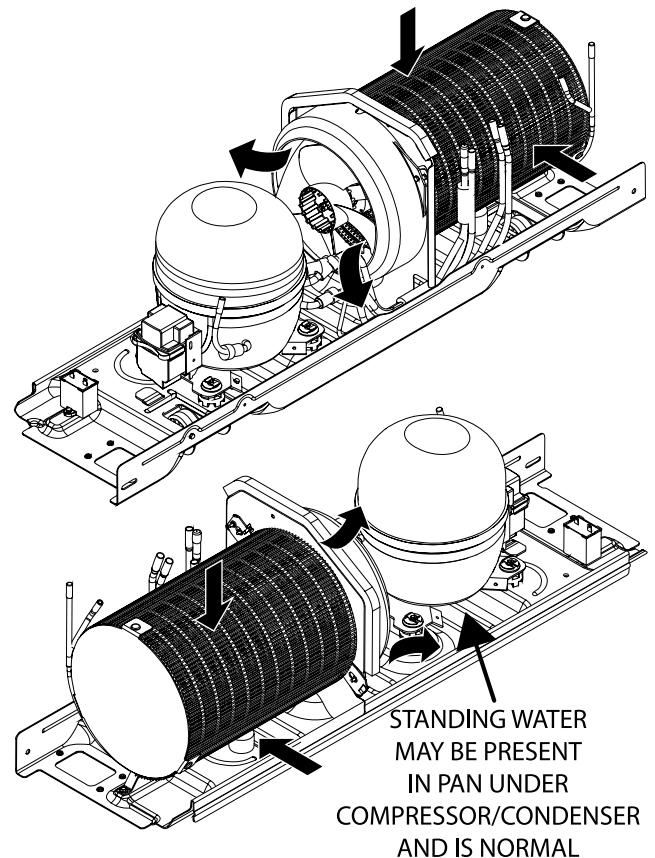

The new NO CLEAN condenser is accessed from the rear and is designed to be tolerant of up to 2 inches of lint. The idea is that the consumer, in normal operating conditions, will never have to clean the condenser. If necessary, only an ordinary appliance brush is used. Air is drawn in from the outside diameter of the condenser and pulled out by the condenser fan. A condenser fan baffle is located at the rear to direct airflow through the condenser. Functionally, the condenser does the same job as previous models. Air is drawn in from front left and rear left and exits out front right side of refrigerator.

Main Control Board

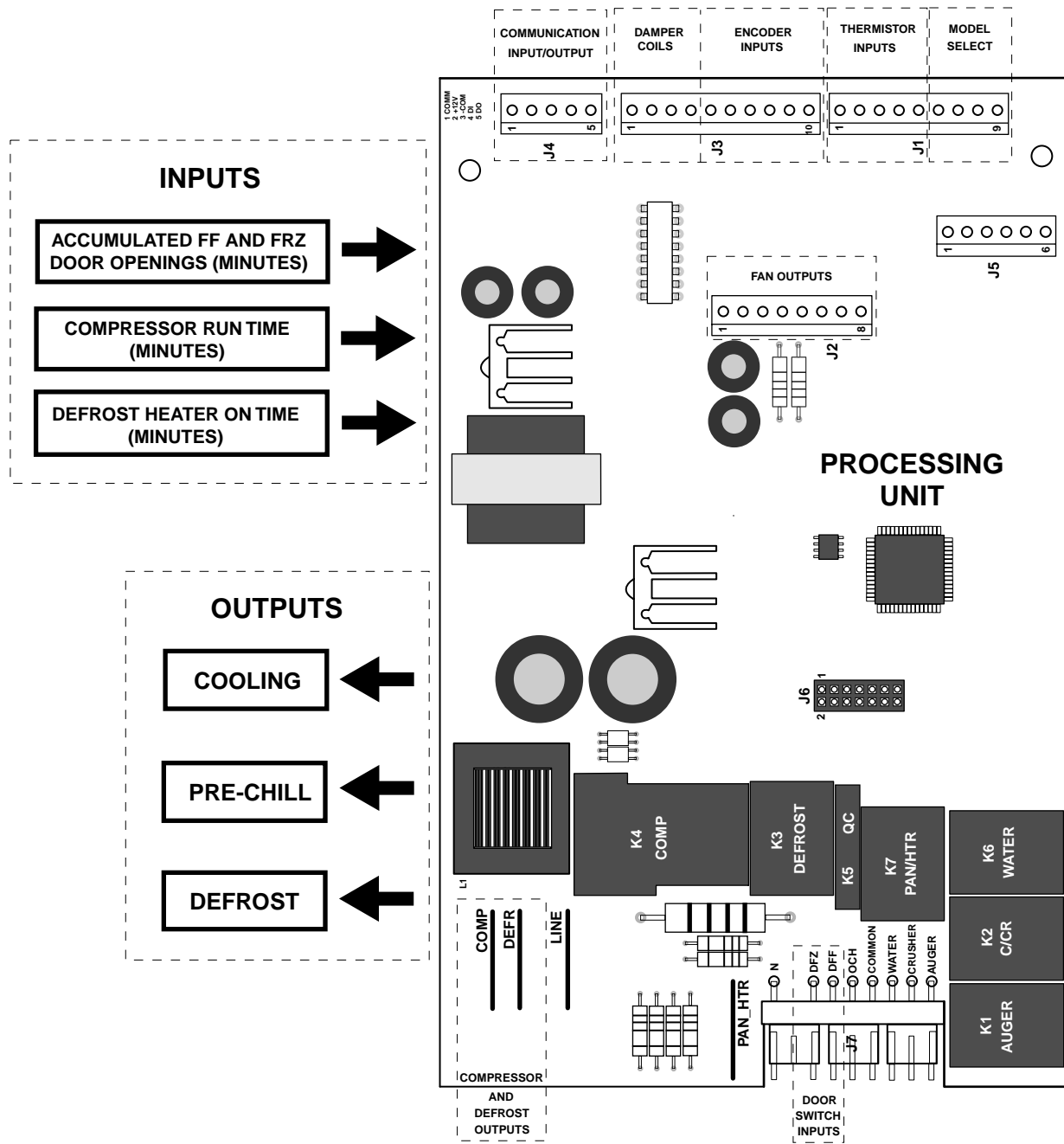

General Locator Views

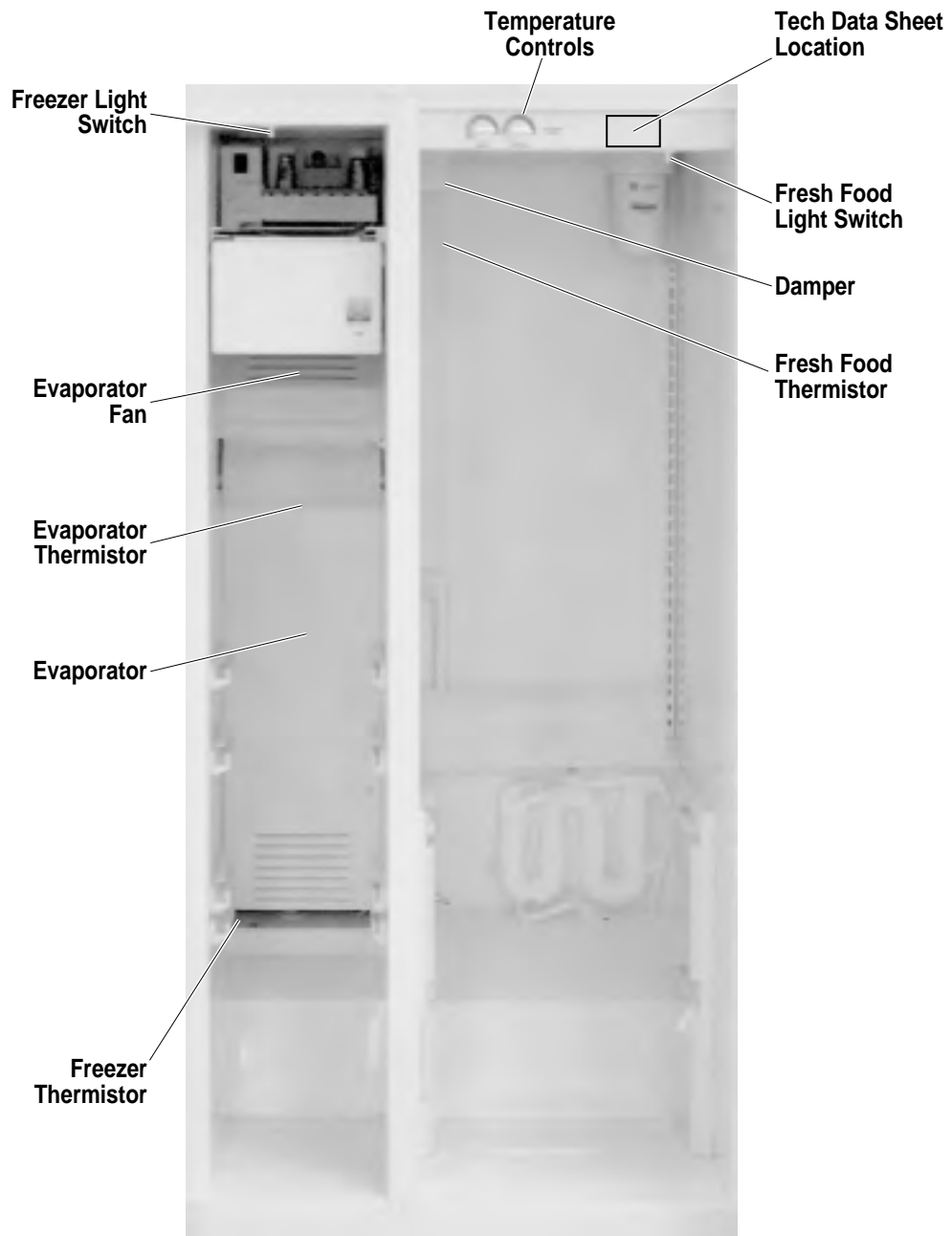

GEA00914

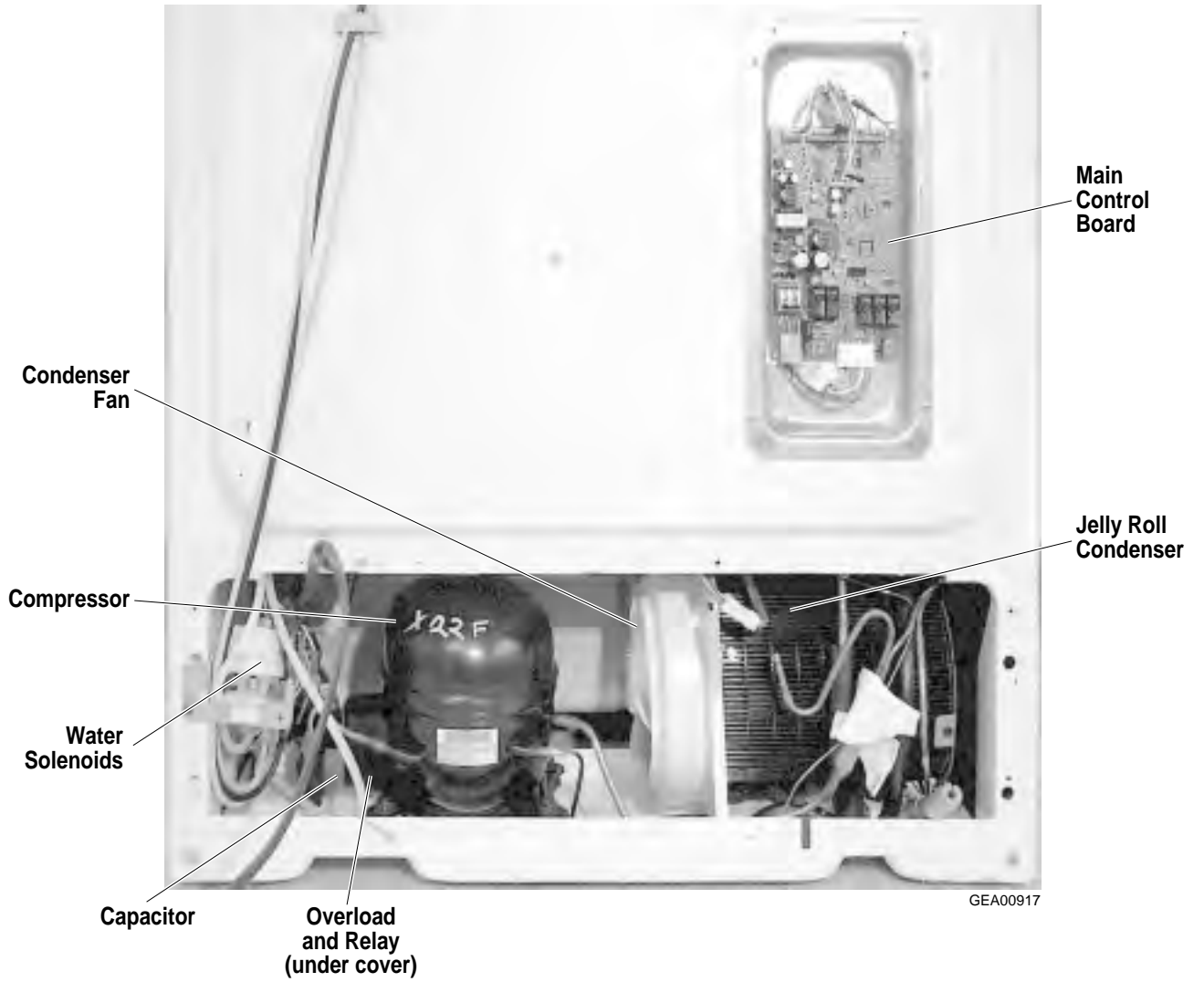

Mechanical Disassembly

Table of Contents

Door Gasket.....	17
Door Handles.....	17
Doors and Door Hinges	17
Door Removal	17
Fresh Food Door Adjustment	18
Control Panel.....	18
Fresh Food Light.....	19
Freezer Door Light Switch	19
Water Filter Cartridge	19
Shelves.....	20
Drawers and Bins	20
Door Shelf Extenders	21
Freezer Light	21
Icemaker.....	21
Ice Dispenser Drive.....	22
Evaporator Fan	22
Defrost Heater and Freezer Thermistor	23
Overtemperature Thermostat and Evaporator Thermistor	24

Fresh Food Thermistor	24
Door Dispenser Control Panel	24
Door Dispenser Target Switch	24
Ice Crusher	25
Ice Dispenser Drive Motor	25
Ice Cube Solenoid	26
Evaporator	26
Condenser Fan	27
Dispenser Heater	27
Main Control Board	28
Roller Assembly	28
Water Solenoid	28
Fresh Food Air Damper	29

Door Gasket

The rear flange of the gasket is positioned between the inner and outer door panels. The screws under the gasket flap **must** be loosened.

1. Remove the door bins.
2. Loosen 40 screws located under the door gasket.
3. Remove the gasket from the interior of the door liner.

Note: The back side of the door liner has double-sided tape at the corners.

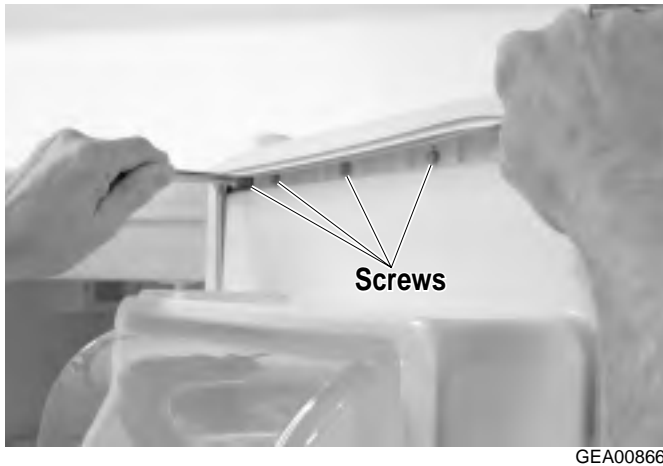

Door Handles

Door handles are front mounted and secured with Torx-style screws.

1. Remove the handle trim covers by inserting a thin flat-blade screwdriver about 2 in. from the end of top cover trim. Pry up enough to insert your fingers and lift to free trim from 2 plastic locking tabs inserted in rectangle door holes. Reverse to reinstall, taking care to align cover trim correctly. The top and bottom are not interchangeable.
2. Remove 2 T-20 Torx screws from the upper and lower ends of the handle.
3. Remove the handle.



Doors and Door Hinges

IMPORTANT: The freezer door is not adjustable. The fresh food door can be adjusted up and down to match the height of the freezer door. Adjust the fresh food door up or down using the hinge adjustment pin (located on the fresh food lower door hinge).

The fresh food and freezer lower door hinges are equipped with replaceable cam risers. Cam risers assist in door closure.

When the fresh food door is adjusted too high, the cam riser will not be engaged. If the cam riser is not engaged, the door will not close properly. Refer to the Fresh Food Door Adjustment section in this chapter for more information.

IMPORTANT: The refrigerator rollers must be adjusted correctly to ensure proper door closure. Refer to the Roller Assembly section in this chapter for more information.

Door Removal

1. Remove the upper hinge cover by removing the Phillips screw.
2. With the door in the closed position, disconnect the wiring harness (freezer side only).



GEA00867

3. Remove the base grille.
4. Disconnect the water supply tube. To disconnect the tube, push in the white collar on the quick connector and pull the tube out.

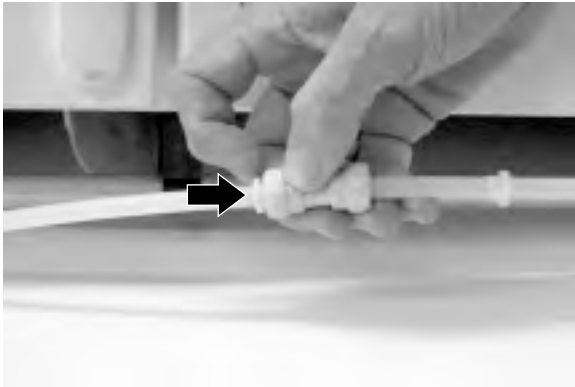

GEA00869

5. Remove the water tube protection (black collar).
6. Remove 2 upper hinge screws.
7. Lift the upper hinge and move it to the side (the gasket is located under the hinge).

CAUTION: Do not side-load hinges.

NOTE: Freezer door only - Guide the water line through hinge while lifting the door from hinge.

8. Open the door 90 degrees and lift the door straight up and off the lower hinge.

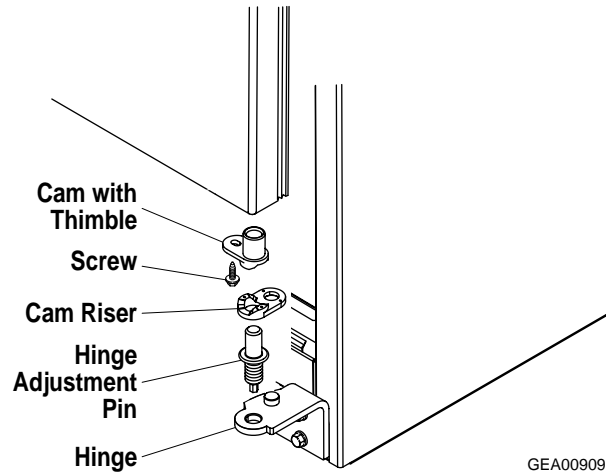

GEA00909

9. Remove the screw, hinge cam, and thimble from the bottom of the door.
10. Fresh Food Door Only: Remove the hinge adjustment pin and cam riser from the lower hinge.
11. Freezer Door Only: Remove the cam riser and washer from the lower hinge.
12. Remove 2 screws and lower hinge from cabinet.

Fresh Food Door Adjustment

IMPORTANT: The refrigerator rollers must be adjusted correctly to ensure proper door closure. Refer to the Roller Assembly section in this chapter for more information.

The freezer door is not adjustable. The fresh food door can be adjusted to match the height of the freezer door.

1. Remove the base grille (opening the door makes grille removal easier).
2. Turn the hinge adjustment pin (located on the fresh food lower hinge) clockwise to raise the door and counterclockwise to lower the door.

Control Panel

The control panel, located at the front of the fresh food compartment, contains temperature control encoders for fresh food and freezer sections and the fresh food door light switch.

1. Remove 2 screws located in the bottom of the control panel. Slide the panel down.

2. Disconnect the connectors for the door light switch and temperature control switches.

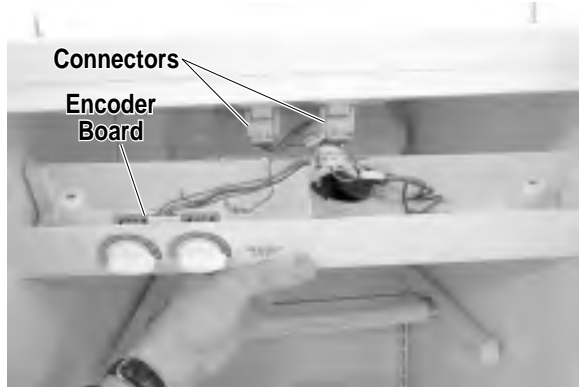

GEA00870

3. Disconnect the connectors for the light and temperature control encoders.
4. Disconnect the temperature control encoder connector.
5. Remove the mounting nuts for both encoders.

Note: Both switches **must** be replaced because they are mounted on a common circuit board.

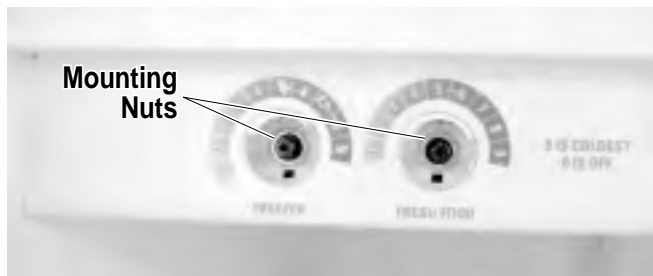

GEA00871

6. Disconnect the refrigerator door light switch supply connector.
7. Push the locking tab in and slide the switch out of the panel.

Fresh Food Light

The lower fresh food light is located under an opaque cover in the lower portion of the fresh food compartment in some models.

Note: The upper light cover removal is covered in the previous procedure.

1. Remove the lower light cover by lifting it off the dowels.
2. Remove 2 40-watt appliance light bulbs.



GEA00872

Freezer Door Light Switch

The freezer door light switch is located on the left of the freezer compartment.

1. Slide a small flat-blade screwdriver under the switch and push the locking tab. Pull out the switch.
2. Disconnect the harness connector and remove the switch.



GEA01014

Water Filter Cartridge

Note: The water filter should be replaced every 6 months. Warranty life is 30 days.

The water filter cartridge is located in the upper right corner of the fresh food compartment. When the LED illuminates, change the water filter. On those models without the LED, change the filter when the water flow decreases to the dispenser or icemaker.

1. Remove the old cartridge by slowly turning it to the left. Do **not** pull the cartridge down. A small amount of water may drip when the cartridge is removed.

2. On models without a replacement LED, apply the year and month sticker to the new cartridge.
3. Line up the arrow on the cartridge with the cartridge holder. Place the new cartridge up and inside the holder. Do **not** push it into the holder.
4. Slowly turn the cartridge to the right until it stops (about 1/2 turn). Do **not** overtighten. The cartridge will automatically raise itself into position.
5. Run water from the dispenser for 3 minutes (about 1-1/2 gallons) to clear the system and prevent sputtering.
6. On models with the LED, press and hold the RESET WATER FILTER pad on the dispenser.

Note: A filter bypass plug **must** be used if a replacement filter is not available. The dispenser and icemaker will not operate without a filter or the filter bypass plug installed.



GEA00729

Shelves

The slide-out and Spillproof shelves allow access to items stored behind other items. Spillproof shelves have special edges to help prevent spills from dripping onto lower shelves.

The QuickSpace shelf splits in half and slides under itself to allow for storage of tall items on the shelf below. To adjust this shelf:

1. Tilt the shelf up until the tab disengages from the shelf track.
2. Lift the lower tab out of the shelf track.
3. Slide the front half of the shelf under the back half.

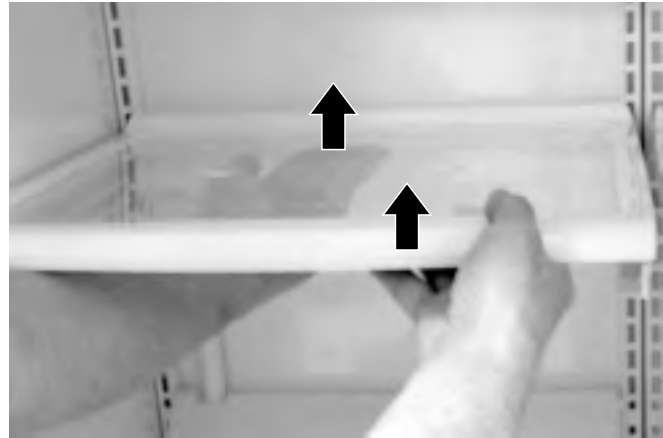

GEA00873

Drawers and Bins

The refrigerator uses drawers (fresh food) and bins (freezer) to store food.

Adjustable humidity drawers allow vegetables to be stored at high humidity or fruits at low humidity. A convertible meat drawer with variable control regulates cold air from the freezer compartment to circulate around the drawer.

1. Pull out the drawer or bin until it reaches the mechanical stops.
2. Lift the drawer or bin up and pull it out of the compartment.



GEA00874

Freezer Light

The freezer light is attached to the evaporator fan housing.

1. Remove the light cover by lifting it off the tabs.
2. Replace the appliance light bulb.



GEA00877

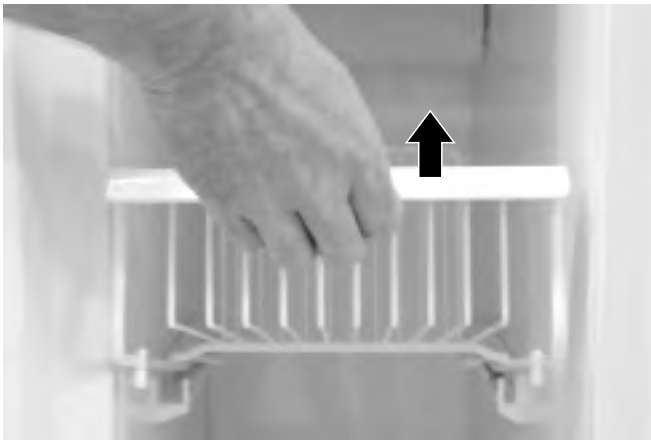

GEA00875

Icemaker

The icemaker is located in the rear of the freezer compartment. The icemaker **must** be replaced as a complete unit.

1. Slide out the upper icemaker dispenser tray and drawer.



GEA00878

Door Shelf Extenders

Detachable shelf extenders deepen and enclose fixed door shelves, providing more storage and greater storage flexibility.

1. Lift the shelf extender straight up until it disengages from the locking device.
2. Pull out the shelf extender.



GEA00876

2. Loosen 2 mounting screws.

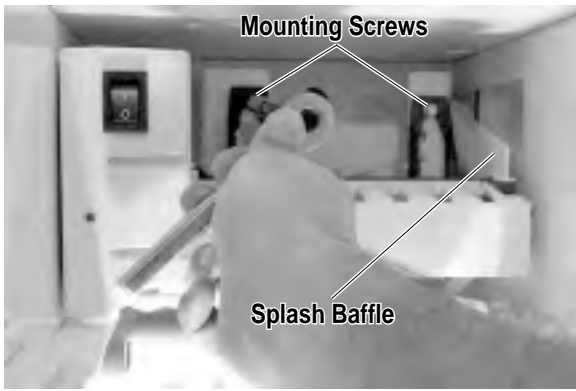

GEA00879

3. Lift up the icemaker and slide it out until the cable connection is exposed.

Note: When replacing the icemaker, the fill cup and splash baffle **must** be reused.

4. Disconnect the cable connector.

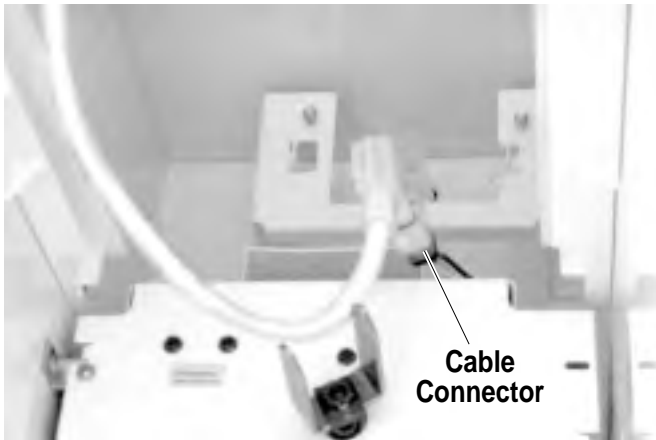

GEA00880

5. Loosen 3 screws on the icemaker bracket.
6. Lift up the bracket and slide it out.

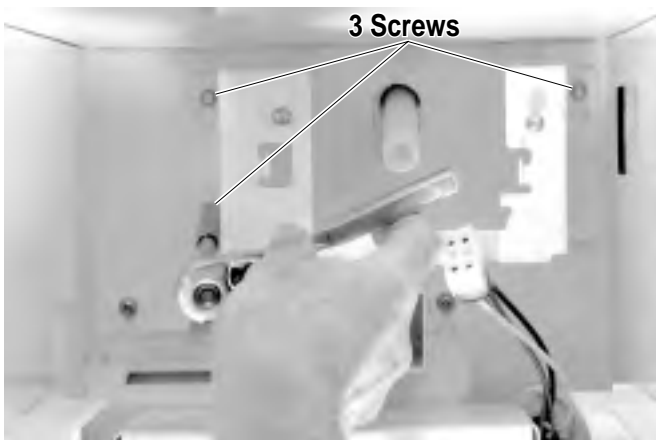

GEA00881

Ice Dispenser Drive

The ice dispenser drive turns the ice dispenser auger in either crushed or cube mode.

1. Remove 2 Phillips screws from the ice dispenser drive.
2. Slide the dispenser out until the cable connector is visible.
3. Disconnect the cable and remove the dispenser drive.

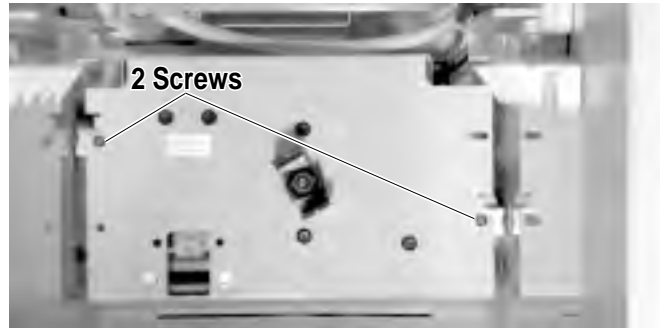

GEA00882

Evaporator Fan

The evaporator fan, located in the upper portion of the freezer compartment, circulates cold air through the fresh food and freezer compartments.

1. Remove auger motor housing.
2. Loosen 4 Phillips screws located in the lower portion of the evaporator fan duct.
3. Lift up the duct and slide it out.



GEA00883

4. Remove 4 Phillips screws from the evaporator cover.
5. Remove the evaporator cover.
6. Disconnect the evaporator fan cable connectors and the ground wire.
7. Loosen 2 Phillips screws from the evaporator fan mounting.

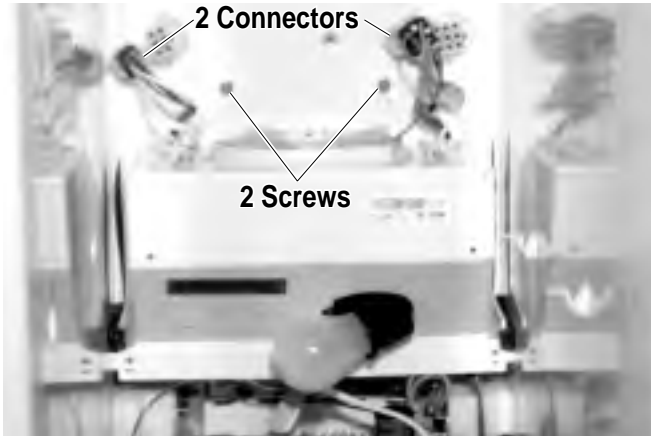

GEA00884

8. Pull out the fan and remove the light and defrost heater wiring harness.
9. Remove the fan.



GEA00885

Defrost Heater and Freezer Thermistor

The defrost heater warms the evaporator during the defrost mode of operation. The freezer thermistor, located at the bottom left side of the freezer compartment, senses the temperature in the freezer.

1. Complete steps 4 and 5 in the previous procedure.
2. Remove 2 Phillips screws from the defrost heater.
3. Remove the heater.

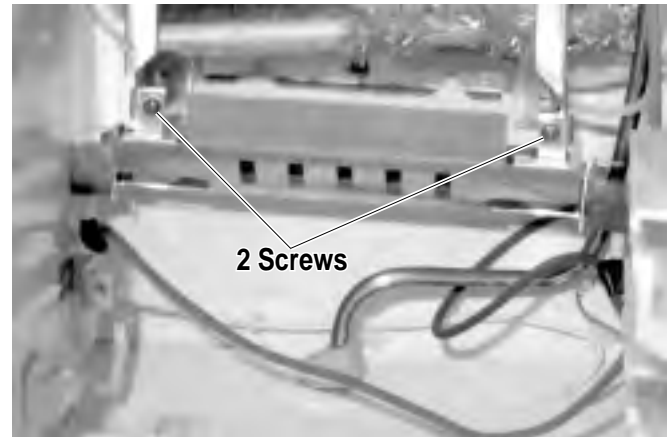

GEA00886

4. Remove the freezer thermistor.

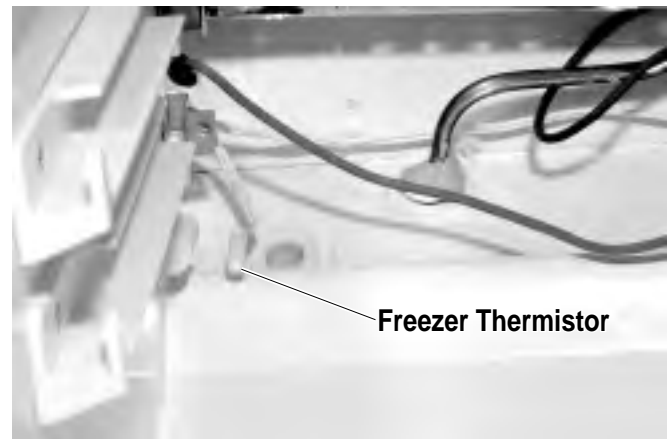

GEA00887

Overtemperature Thermostat and Evaporator Thermistor

The main control board monitors the resistance of the evaporator thermistor. The main control board will terminate the defrost cycle when a predetermined temperature (60° F) is reached. The over-temperature thermostat is a redundant defrost terminating device. It will also terminate defrost in the event of a failure of the evaporator thermistor.

1. Remove the overtemperature thermostat.
2. Remove the evaporator temperature thermistor.

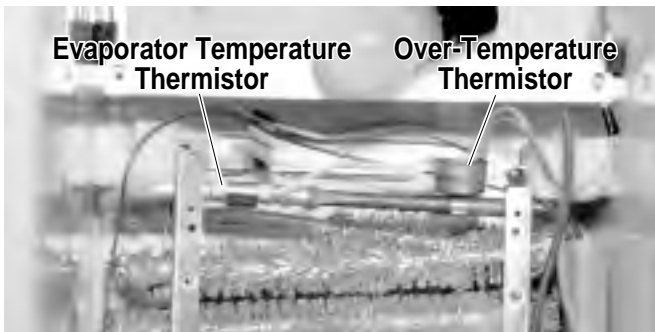

Fresh Food Thermistor

The fresh food thermistor, located in the top, left of the fresh food compartment, hidden behind the bin track at the top left, senses the compartment temperature.

1. Disengage the plastic track by sliding upward and remove the housing.
2. Remove the thermistor from the housing.

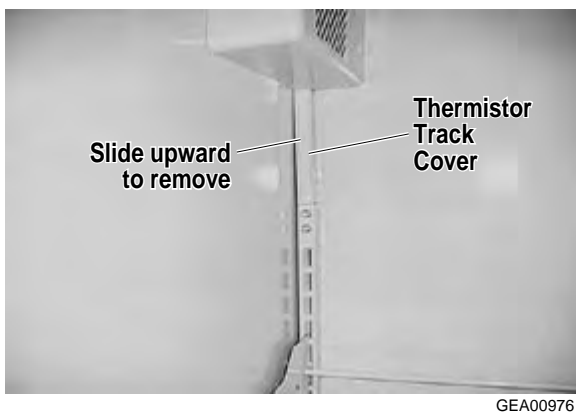

Door Dispenser Control Panel

The door dispenser control panel allows the consumer to select water, crushed ice, or ice cubes. It is an interface to the main control board.



1. Use a screwdriver to unlock the tabs at the bottom of the control panel. Slide the bottom out and down.
2. Disconnect the wiring harness connectors.

Note: Inner door panel must be removed to remove recess trim.

Door Dispenser Target Switch

When depressed, the door dispenser target switch allows water, ice cubes, or crushed ice to be dispensed.

1. Remove door dispenser control panel (see previous procedure).
2. Remove 4 Phillips screws in the door dispenser housing.

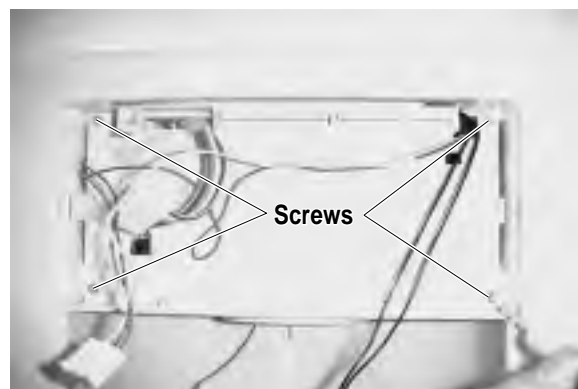

3. Slide out the housing and disconnect the target switch and dispenser light connectors.



GEA00974

4. Spread out the locking tabs and remove the switch.
5. Push the chute duct door locking tabs back and raise the assembly above the locking tabs.
6. Push the lower armature locking tabs (under the assembly) back and lift up the entire assembly.

Ice Crusher

The ice crusher uses a deflector. When the deflector is UP ("Crushed Ice" is selected on the dispenser control panel), the ice crusher operates. When the deflector panel is DOWN ("Cubed Ice" is selected on the dispenser control panel), the deflector is normally up.

1. Remove the ice dispenser tray and assembly (see page 21).
2. Remove 2 Phillips screws from the ice dispenser cover.

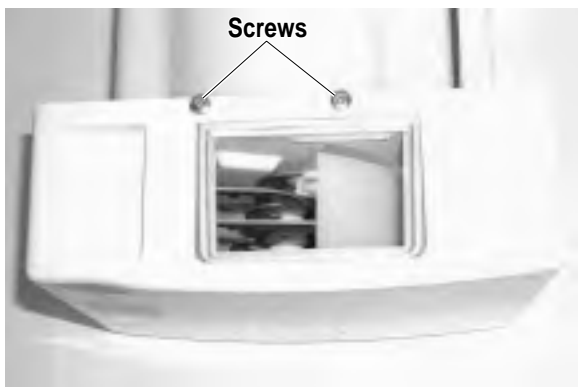

GEA00920

3. Turn over the ice bucket and ice dispenser cover. Remove the Phillips screw.
4. Remove the cover.
5. Remove the Phillips screw for the ice cube control linkage and slide the linkage to the rear of the ice bucket.



GEA00021

6. Using a pair of pliers, break the tabs off the back cover.
7. Using 2 flat blade screwdrivers, disengage the locking tabs at either side of the ice crusher and remove the assembly.



GEA00918

8. Slide the back cover off the auger. The back cover must be replaced because of tabs broken off for disassembly.
9. With a flat-head screwdriver, remove the C-clip from the end of the auger.
10. Remove the auger and ice crusher blade assembly.

Ice Dispenser Drive Motor

The ice dispenser drive motor turns the auger in the crushed or cube mode.

1. Remove the ice dispenser tray and assembly.

2. Remove 2 Phillips mounting screws.
3. Pull out the motor.
4. Disconnect the wire connectors.
5. Remove the drive fork and nut.

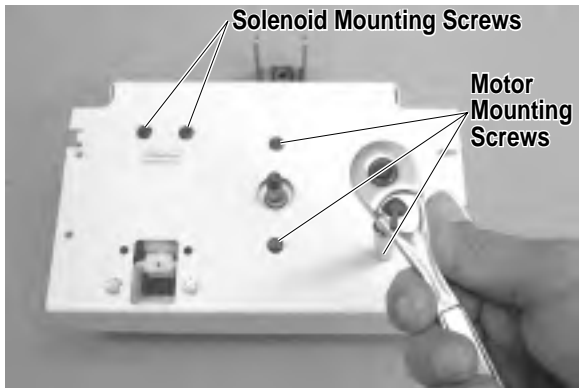

GEA00919

6. Disconnect the motor wiring connectors.

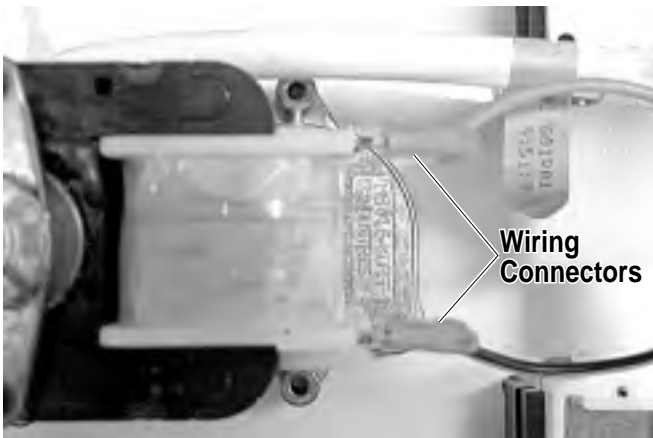

GEA00892

7. Remove 3 motor mounting screws.
8. Remove the motor from the housing.

Ice Cube Solenoid

The ice cube solenoid energizes when the cube mode is selected on the dispenser control panel.

1. Remove the ice dispenser tray and assembly (see page 21).
2. Remove 2 Phillips mounting screws.
3. Pull out the motor.
4. Disconnect the wire connectors.
5. Remove the ground wire to the ice cube solenoid.

6. Disconnect the wire connectors.

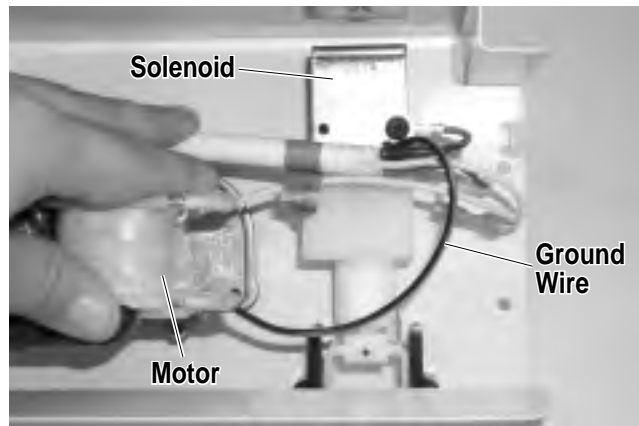

GEA00695

7. Remove 2 solenoid mounting screws.
8. Slide the solenoid out of the housing.

Evaporator

Air is driven across the evaporator coils to produce cold air for the freezer and fresh food compartments. Evaporator is replaced like previous models.

1. Complete steps 4 and 5 in the **Evaporator Fan** procedure.

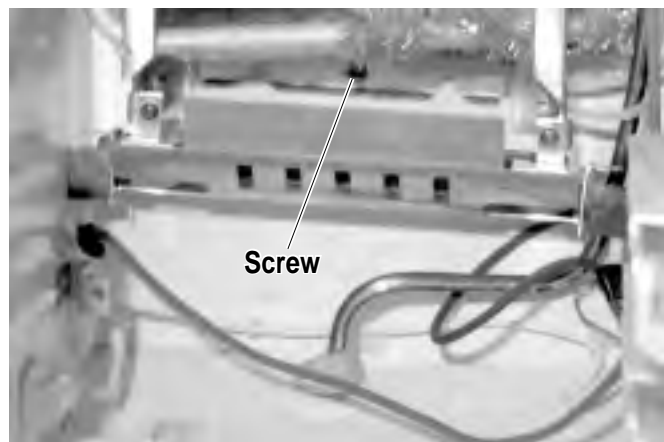

GEA00893

2. Remove 3 Phillips screws from the evaporator mounting.
3. Cut the capillary and suction line.
4. Remove the evaporator.

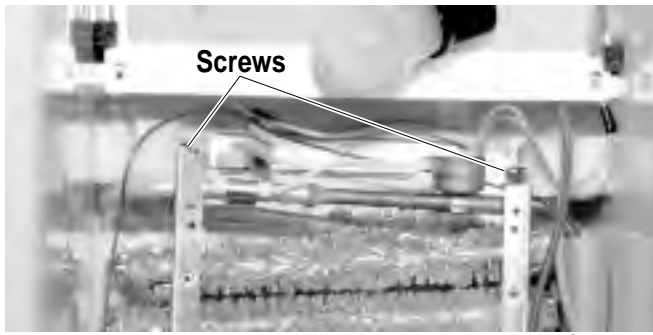

GEA00894

5. With a file, score the capillary tube just above the soldered section. Break off the soldered section of the capillary tube. This helps prevent solder from plugging the tube during assembly.
6. Place a new evaporator into the freezer and insert the suction line and capillary tube into the evaporator.
7. Braze the suction line and capillary tube to the evaporator using silfos.
8. Install a replacement dryer.
9. Evacuate and recharge the system using currently accepted procedures.

Condenser Fan

The condenser fan provides forced-draft cooling for the condenser coil.

1. Remove the machine compartment access cover.
2. Remove 1 screw from the condenser fan mounting bracket.

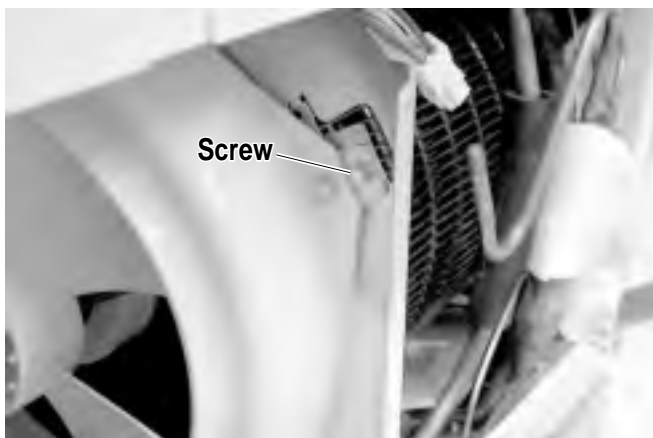

GEA00895

3. Entire fan motor bracket and shroud assembly can be pulled out.

4. Remove 2 screws from the condenser fan cover.
5. Pull out the fan until the electrical connector is exposed.
6. Disconnect the electrical connector.

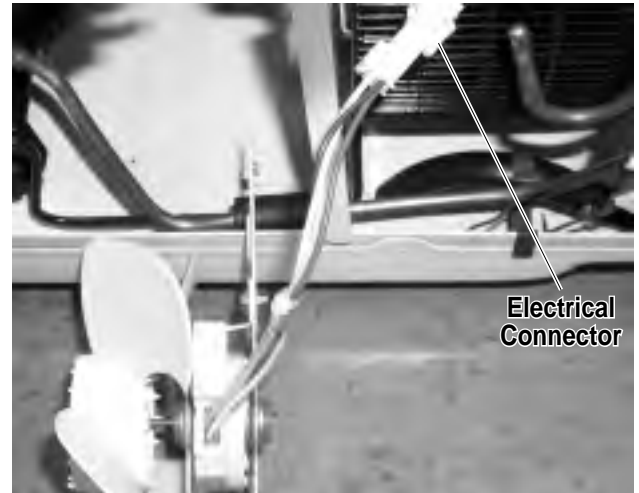

GEA00725

Dispenser Heater

The dispenser heater ensures that the dispensing recess does not sweat in high humidity.

1. Remove 40 door liner mounting screws.
2. Remove the door liner.

Note: The door liner has double-sided tape on the inside corners.

3. Remove the styrofoam dispenser cover.
4. Disconnect the wires and remove the heater.



GEA00981

Main Control Board

The main control board is located in the back of the unit. This board controls the operation of the unit.

1. Unplug the unit and remove the cover.
2. Disconnect all wiring harness connectors from the main control board.
3. Remove the board by unlocking the four plastic board standoffs located on the board.

Note: If standoffs are broken during disassembly, order new parts.

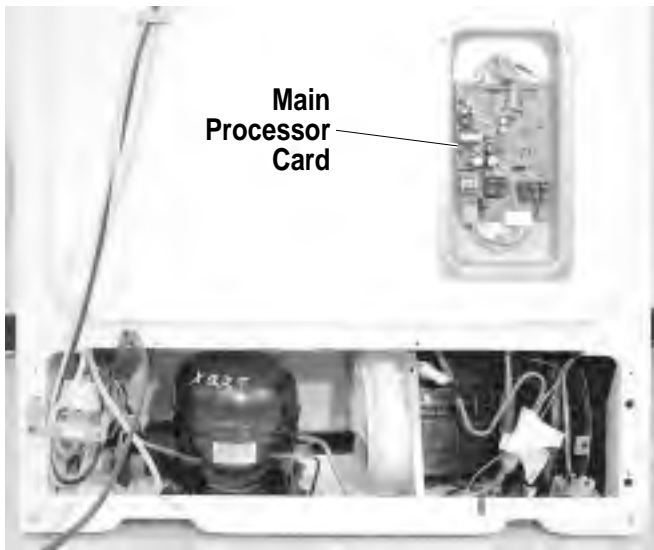

IMPORTANT: To ensure proper door closure, the refrigerator rollers must be adjusted to level the refrigerator. This is different from previous models.

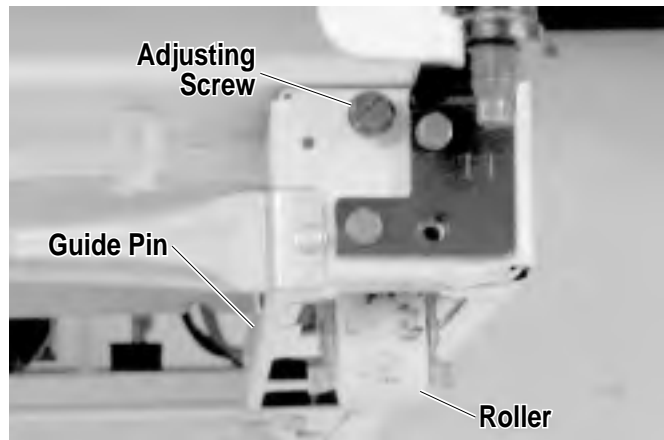

3. Turn the adjusting screw **counterclockwise** until it disengages from the assembly.
4. Remove the roller from the slot.

Water Solenoid

When the solenoids receive a signal from the processor, they route water to the water filter, cooler, and icemaker.

1. Remove the access cover.
2. Remove the solenoid bank bracket screw.

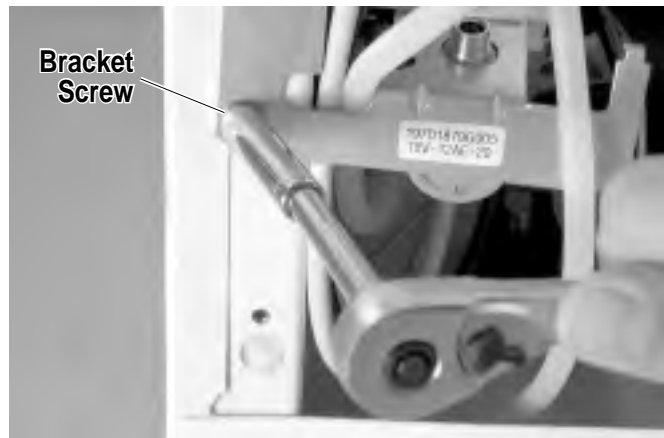

Roller Assembly

Adjustable roller assemblies are located at the bottom front of the unit. They are adjustable and replaceable.

1. Unsnap the base grille from the bottom of the unit.
2. Remove the guide pin with a flat-head screwdriver.

3. Pull out and disconnect the cable connector.

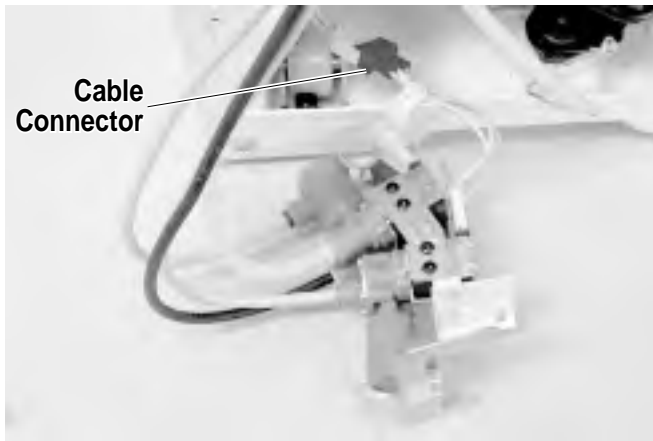

GEA00900

4. Remove 2 Phillips screws from the solenoid connection.
5. Disconnect the water tube and remove the solenoid.

Fresh Food Air Damper

The fresh food air damper is located in the upper left corner of the fresh food compartment. The damper opens to allow cold air to circulate from the freezer to the fresh food compartment.

1. Remove 2 damper cover screws.
2. Remove the damper cover.
3. Using a flat-head screwdriver, remove the damper assembly from the mullion divider until the wire connector is exposed.
4. Disconnect the motor wire connectors.
5. Damper will be replaced as an assembly.

Diagnostics

Table of Contents

Efficient Use of Diagnostics	32
Failure Causes (Table 1)	33
Main Control Board (Low-Voltage Side)	34
Main Control Board (120 VAC Side)	35
Main Control Board Locator Table (Low-Voltage Side)	36
Main Control Board Locator Table (120 VAC Side)	38
Fresh Food Warm - Freezer Warm (Diagnostic Chart)	39
Freezer Warm - Fresh Food Normal (Diagnostic Chart)	40
Fresh Food Warm - Freezer Normal (Diagnostic Chart)	41
Fresh Food Too Cold - Freezer Normal (Diagnostic Chart)	42
Refrigerator Dead - No Sound, No Cooling (Diagnostic Chart)	43
Evaporator Fan Not Running (Diagnostic Chart)	44
Condenser Fan Not Running (Diagnostic Chart)	45
Damper Door Not Operating (Diagnostic Chart)	46
Compressor Not Running (Diagnostic Chart)	47
Heavy Frost On Evaporator (Diagnostic Chart)	48
Thermistor Values (Table 2)	49

Efficient Use of Diagnostics

For most efficient use of the diagnostics, find the appropriate diagnostic chart and proceed as directed in the chart. When directed to take a thermistor reading, refer to Table 2, Thermistor Values.

Table 1. Failure Causes

Freezer Compartment		Fresh Food Compartment	
Above 15 Fahrenheit	High-resistance freezer thermistor Low-resistance evaporator thermistor Condensor fan failure Evaporator fan failure Defrost heater stuck on Door switch failure Main control board faulty Harness faulty Dispenser flap open Door gasket leak Door open Sealed system failure	Above 50 Fahrenheit	High-resistance fresh food compartment thermistor Damper closed Evaporator fan failure Door switch failure Main control board faulty Harness faulty Door gasket leak Door open
Cycle Normal (between 14 and -14 Fahrenheit)		Cycle Normal (between 49 and 33 Fahrenheit)	
Below -15 Fahrenheit	Damper stuck closed Low resistance in freezer thermistor Main control board faulty Harness faulty	Below 32 Fahrenheit	Damper stuck open Low-resistance fresh food compartment thermistor Main control board faulty Ambient temperature below 60 Harness faulty

Main Control Board (Low-Voltage Side) (Sample only, check schematic shipped with product)

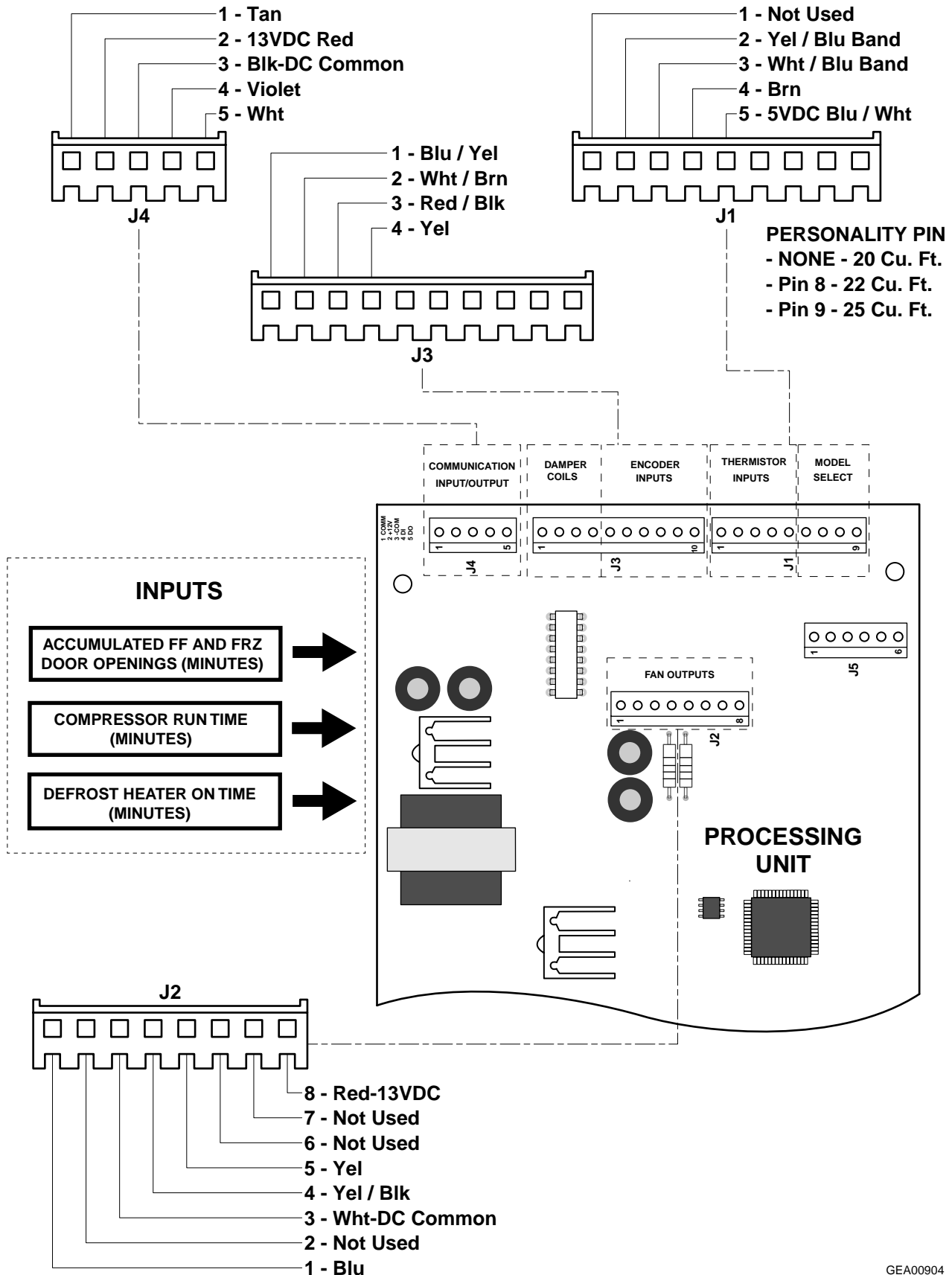

GEA00904

Main Control Board (120 VAC Side)

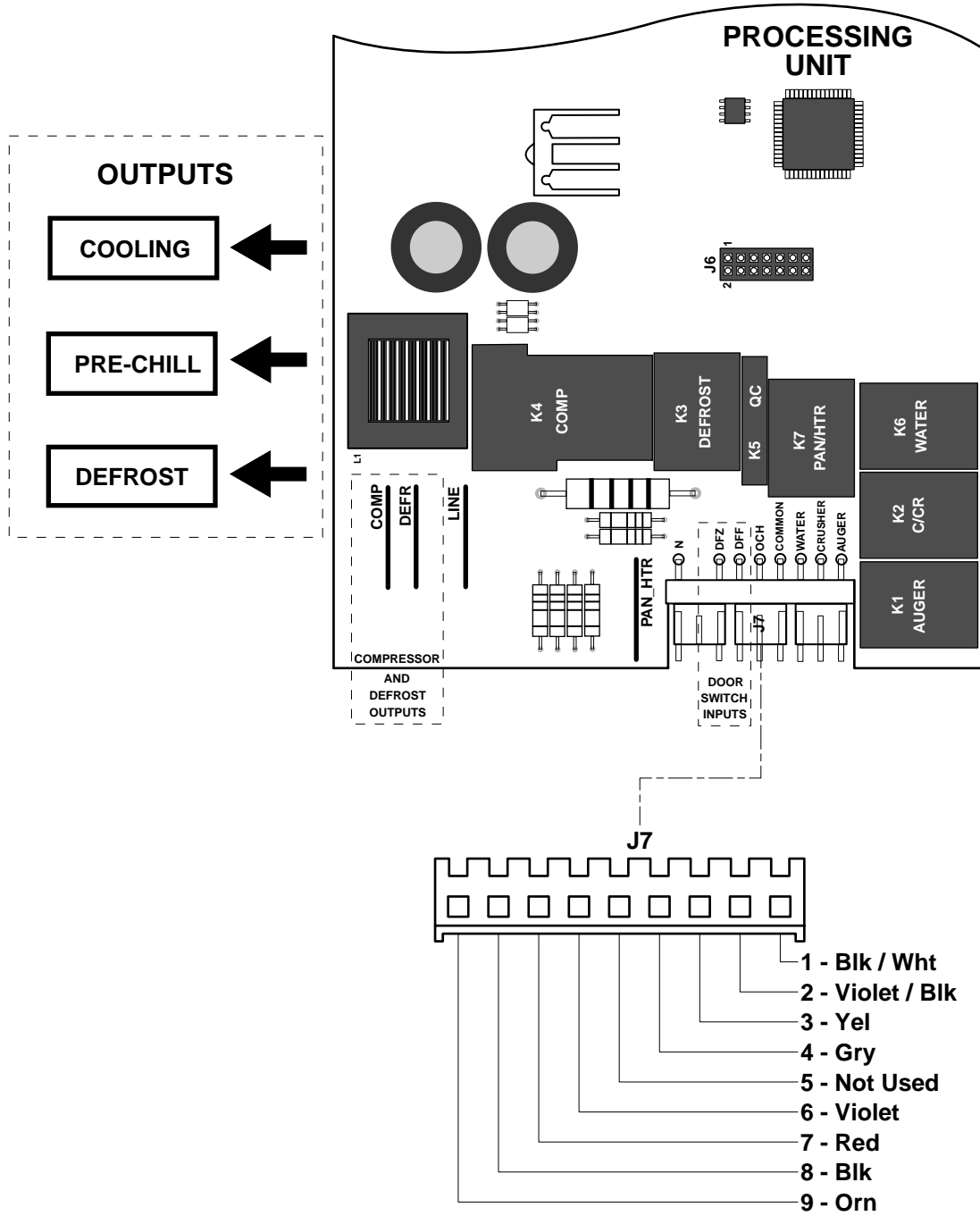

GEA00905

Main Control Board Locator Table
(Low-Voltage Side)

Connector	Pin	Wire Color	Component Termination	Pin-to-Pin Voltage Reading
J1	1	Not used	Not used	Not used
J1	2	Yellow/Blue Band	Fresh food thermistor #1	J1 pin 2 to pin 5 = 2.8 to 3.5 VDC
J1	3	White/Blue Band	Freezer thermistor	J1 pin 3 to pin 5 = 2.8 to 3.5 VDC
J1	4	Brown	Evaporator thermistor	J1 pin 4 to pin 5 = 2.8 to 3.5 VDC
J1	5	5 VDC Blue/White	Thermistor supply voltage (5 VDC)	J1 pin 5 to J4 pin 3 = 5 VDC
J2	1	Blue	Evaporator fan tachometer	J2 pin 1 to pin 3 = 6.3 VDC
J2	2	Not used	Not used	Not used
J2	3	White-DC common	Fan common	J2 pin 3 to pin 8 = 12 VDC
J2	4	Yellow/Black	Evaporator fan	J2 pin 4 to pin 3 = 12.4 VDC (high speed), 8 VDC (low speed)
J2	5	Yellow	Condenser fan	J2 pin 5 to pin 8 = 13.4 VDC (condenser fan is single speed)
J2	6	Not used	Not used	Not used
J2	7	Not used	Not used	Not used
J2	8	Red-13 VDC	Fan supply voltage	J2 pin 8 to pin 6 = 13.4 VDC

Continued on next page.

Main Control Board Locator Table (Low-Voltage Side)				
Connector	Pin	Wire Color	Component Termination	Pin-to-Pin Voltage Reading
J3	1	Blue/Yellow	Damper	J3 pin 1 to J4 pin 3 = Traveling Voltage 6.0 VDC
J3	2	White/Brown	Damper	J3 pin 2 to J4 pin 3 = Traveling Voltage 6.0 VDC
J3	3	Red/Black	Damper	J3 pin 3 to J4 pin 3 = Traveling Voltage 6.0 VDC
J3	4	Yellow	Damper	J3 pin 4 to J4 pin 3 = Traveling Voltage 6.0 VDC
J4	1	Tan	Dispenser board common transmit/receive	See schematic
J4	2	Red	Dispenser board common 13 VDC	See schematic
J4	3	Black-DC common	Dispenser board common ground	See schematic
J4	4	Violet	Dispenser board input 1	See schematic
J4	5	White	Dispenser board input 2	See schematic
Continued on next page.				

Main Control Board Locator Table (120-VAC Side)				
Connector	Pin	Wire Color	Component Termination	Pin-to-Pin Voltage Reading
J7	1	Black/White	Auger motor	J7 pin 1 to J7 pin 9 = 120 VAC*
J7	2	Violet/Black	Cube solenoid	J7 pin 2 to J7 pin 9 = 120 VAC*
J7	3	Yellow	Water valve	J7 pin 3 to J7 pin 9 = 120 VAC*
J7	4	Gray	Auger motor interlock	J7 pin 4 to J7 pin 9 = 120 VAC (freezer door shut)
J7	5	Not used	Not used	Not used
J7	6	Violet	Fresh food door light switch feedback	J7 pin 6 to J7 pin 9 = 120 VAC (fresh food door open)
J7	7	Red	Freezer door light switch feedback	J7 pin 7 to J7 pin 9 = 120 VAC (freezer door open)
J7	8	Black	Not used	Not used
J7	9	Orange	Neutral	Neutral

*** When activated**

Fresh Food Warm - Freezer Warm

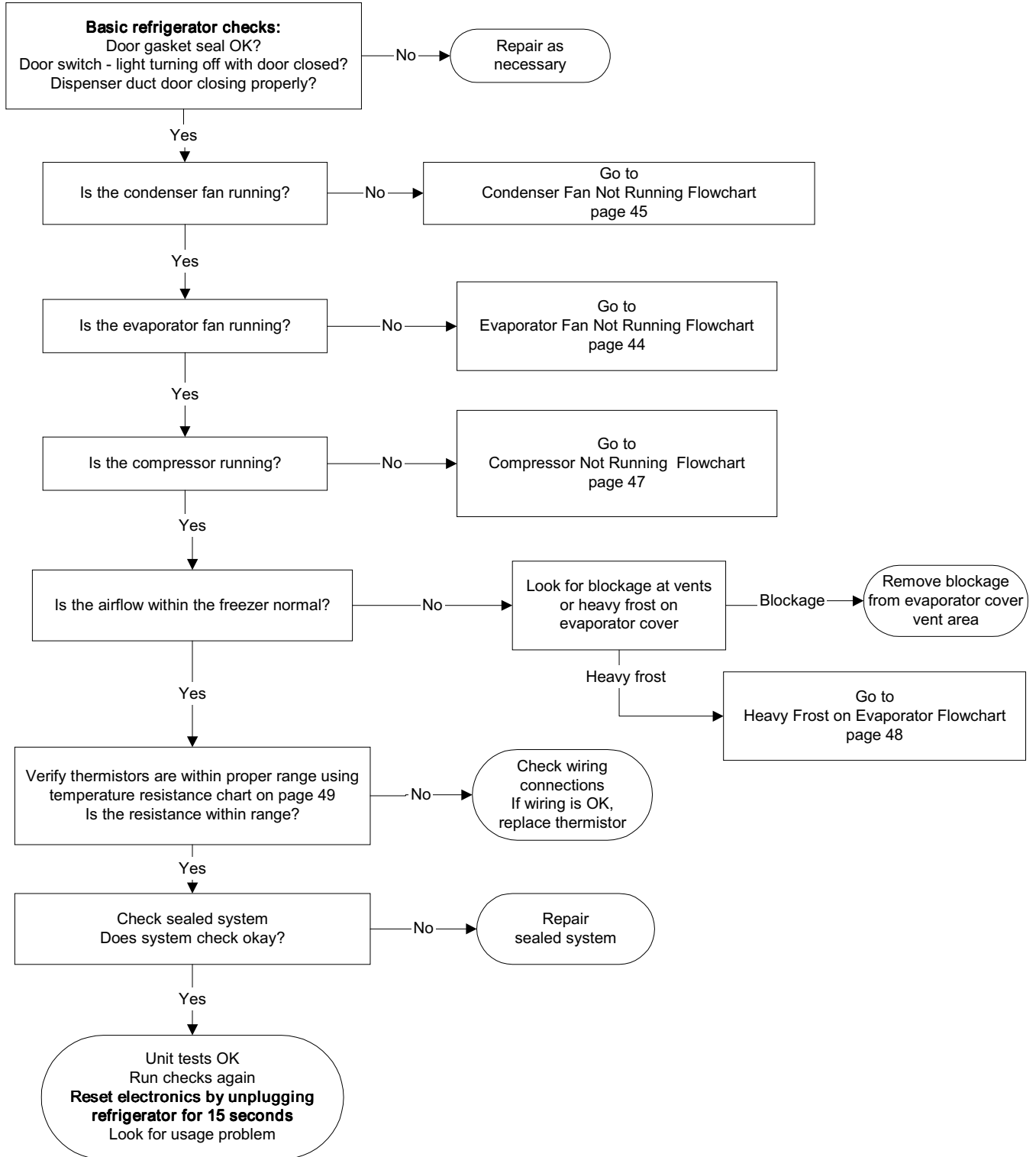

Freezer Warm - Fresh Food Normal

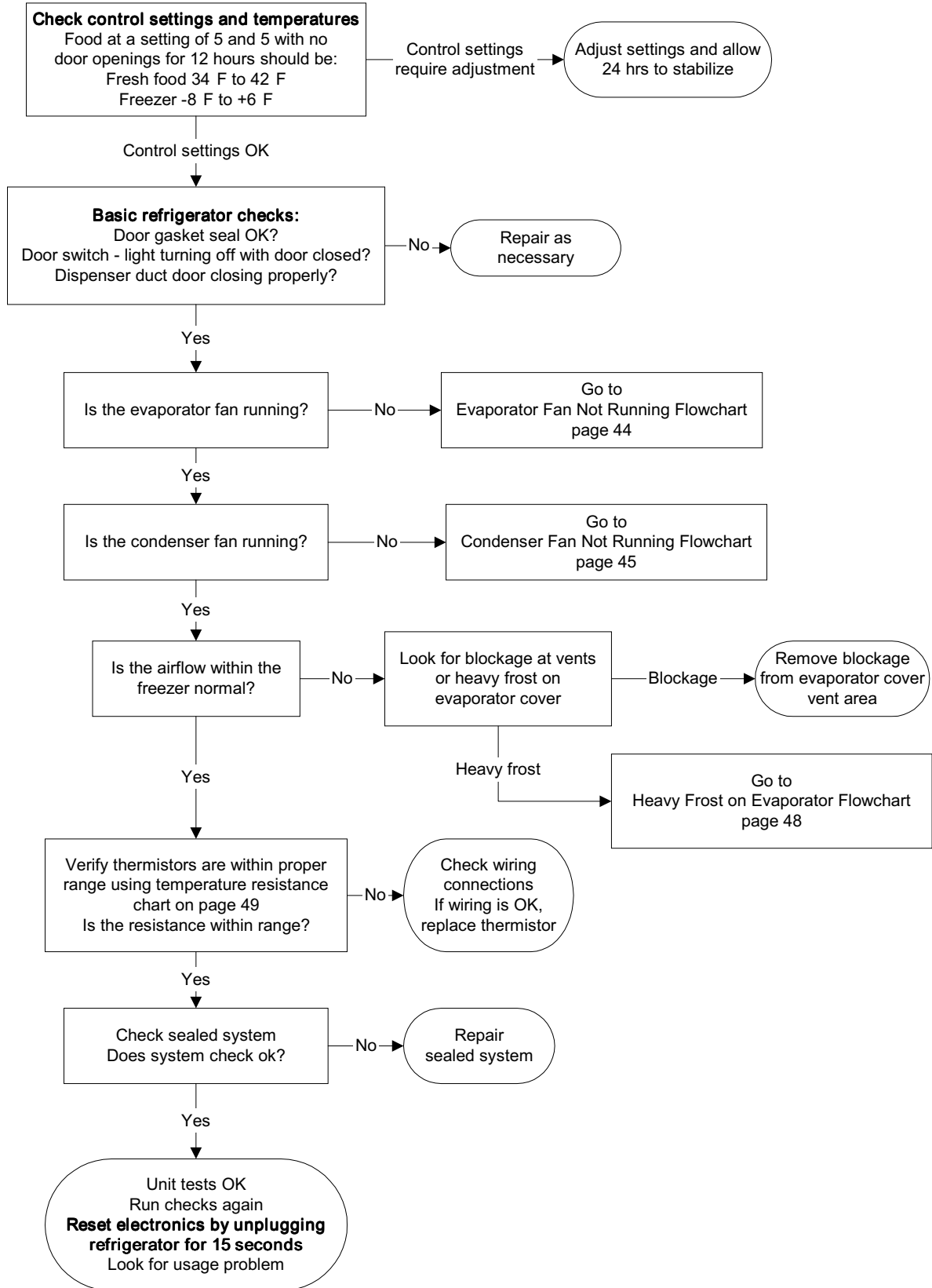

Fresh Food Warm - Freezer Normal

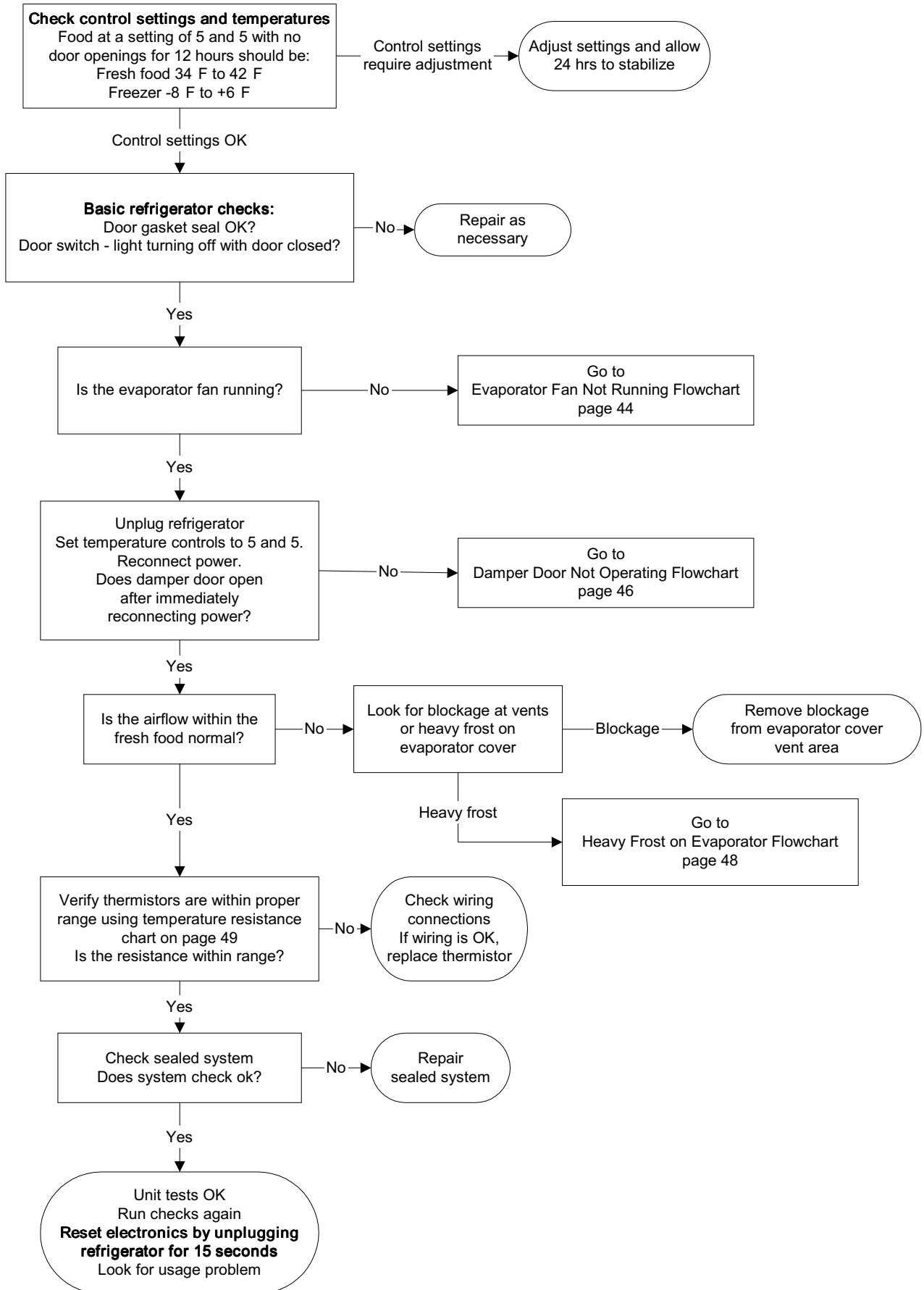

Fresh Food Too Cold - Freezer Normal

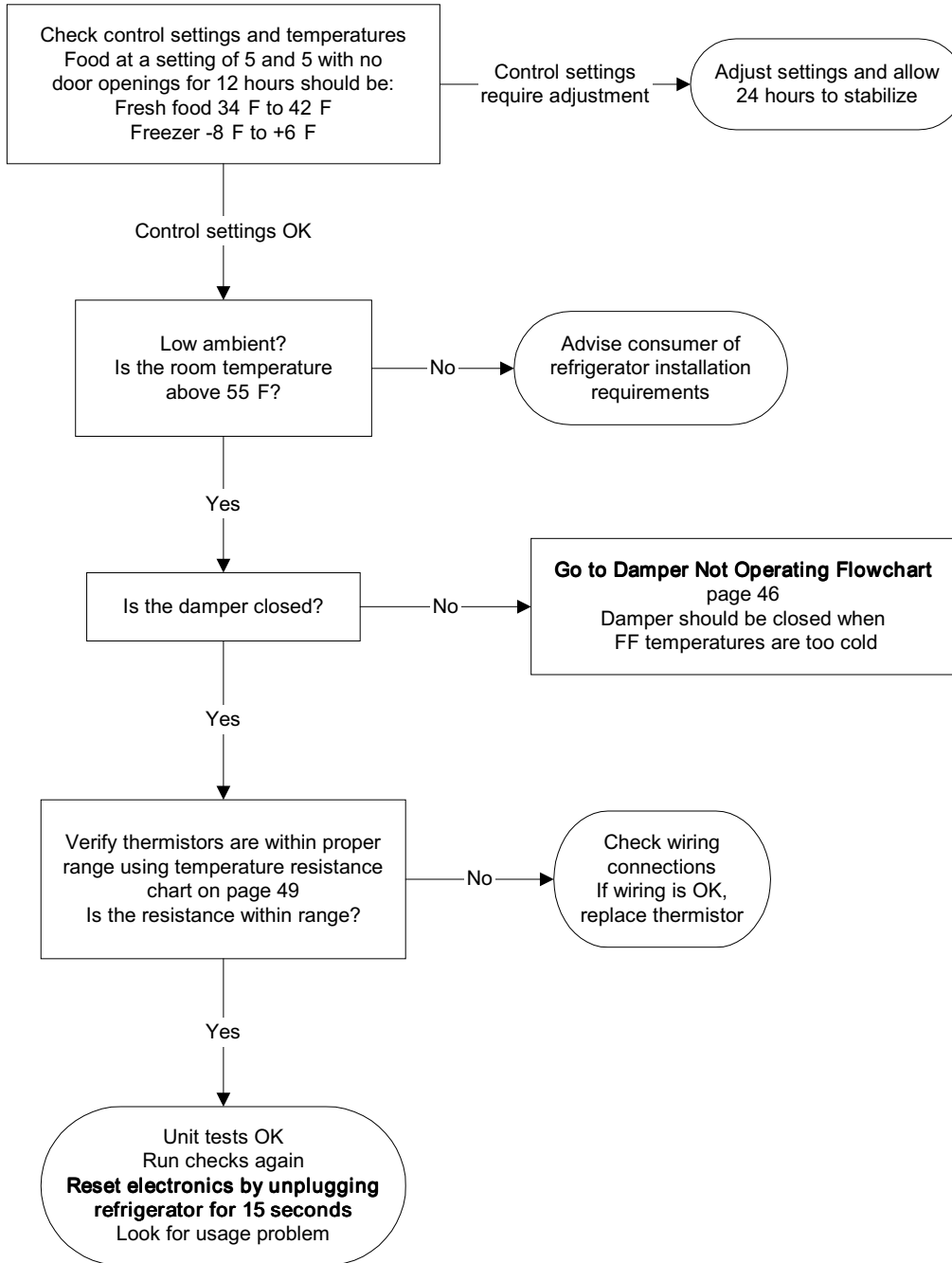

Refrigerator Dead, No Sound, No Cooling

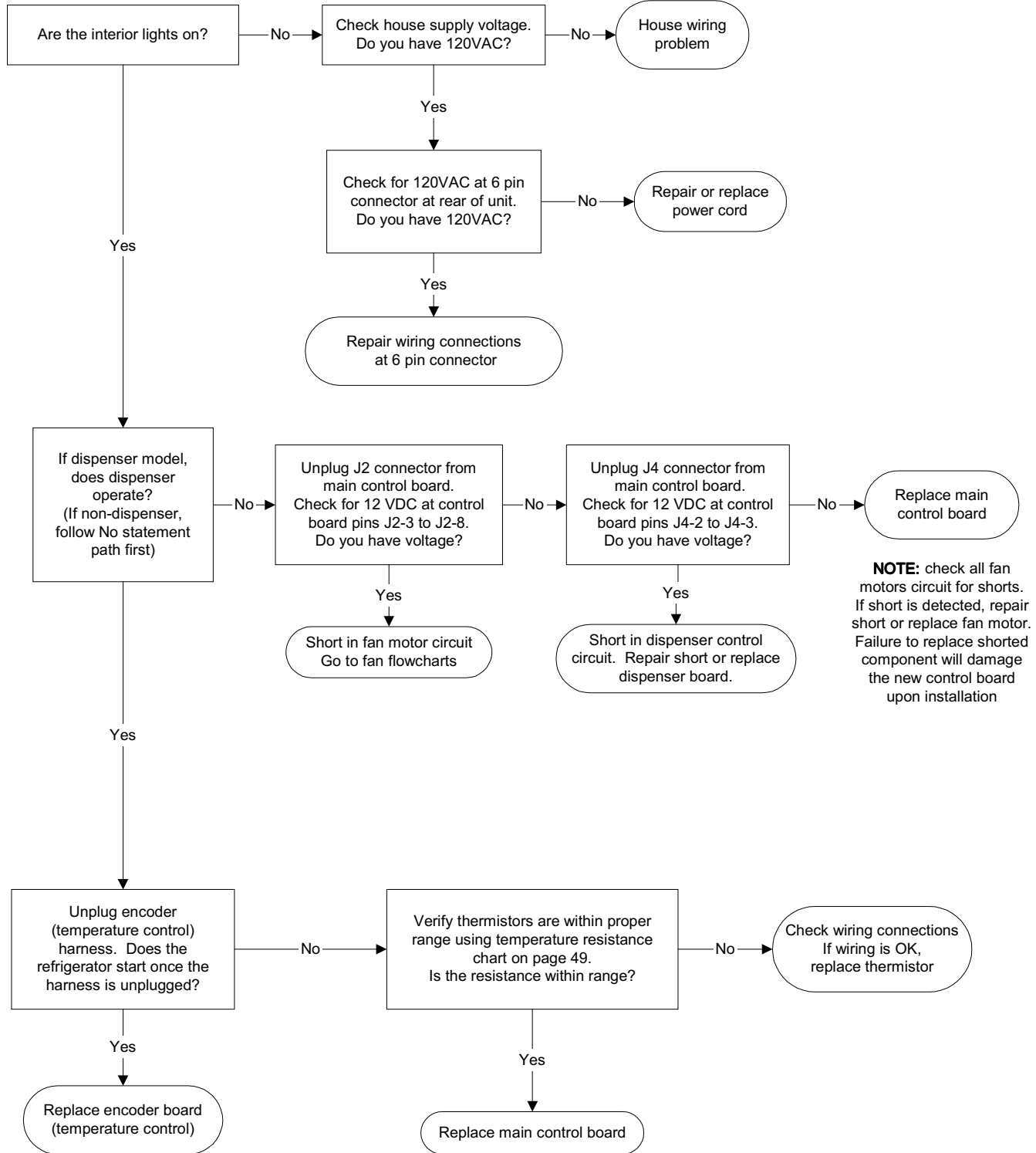

Evaporator Fan Not Running

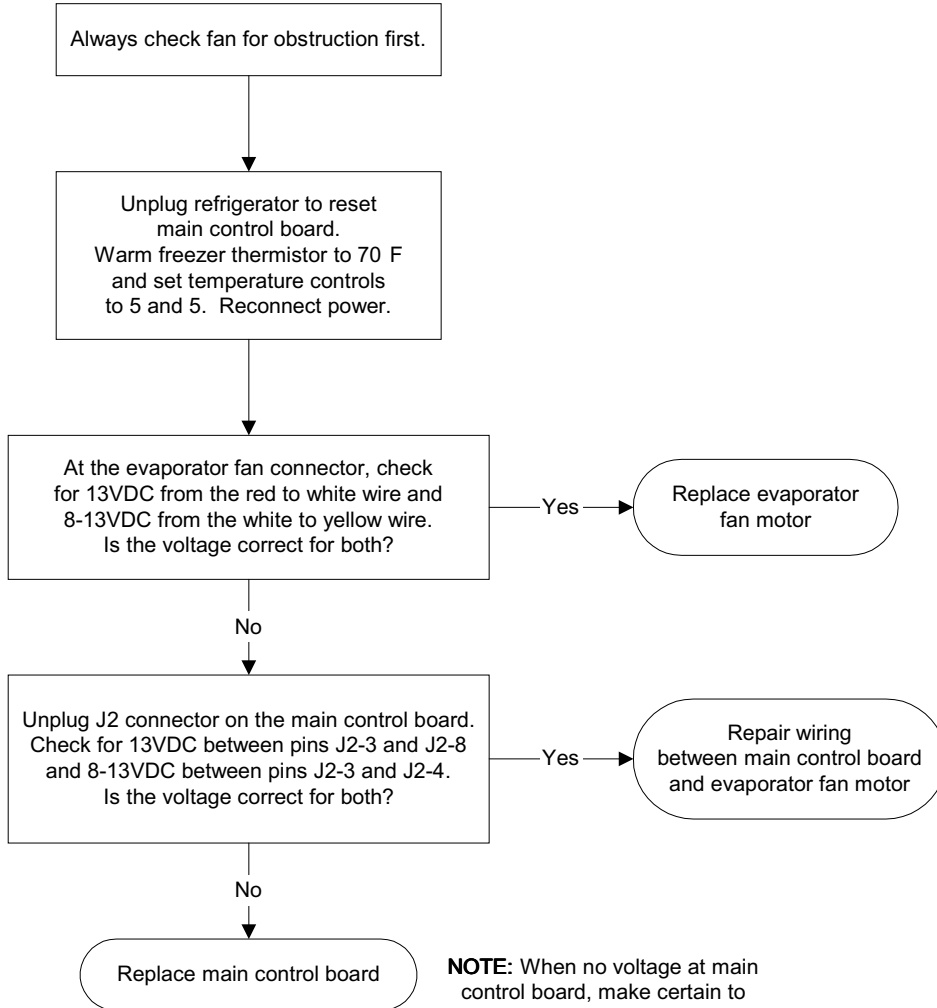

NOTE: When no voltage at main control board, make certain to check for shorted fan motor (less than 1K ohm between white to red or white to yellow). A shorted fan motor will damage the replacement main board.

Condenser Fan Not Running

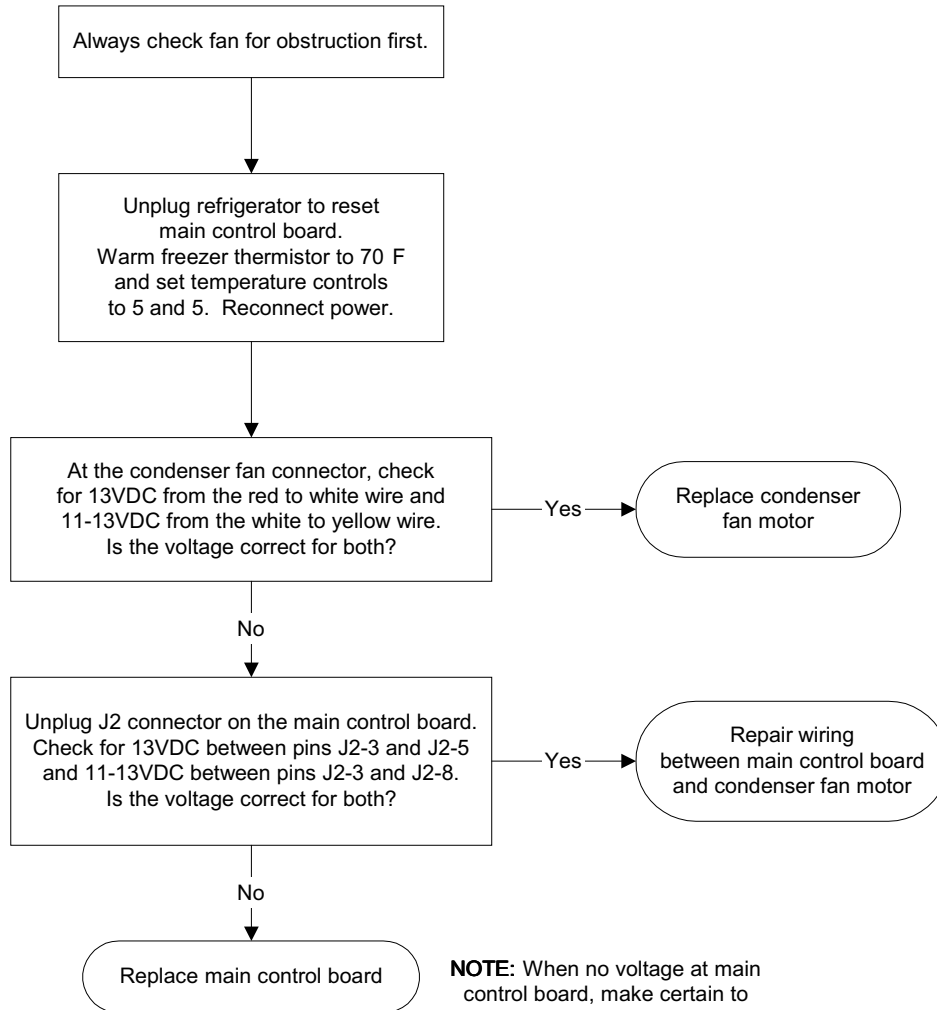

NOTE: When no voltage at main control board, make certain to check for shorted fan motor (less than 1K ohm between white to red or white to yellow). A shorted fan motor will damage the replacement main board.

Damper Door Not Operating

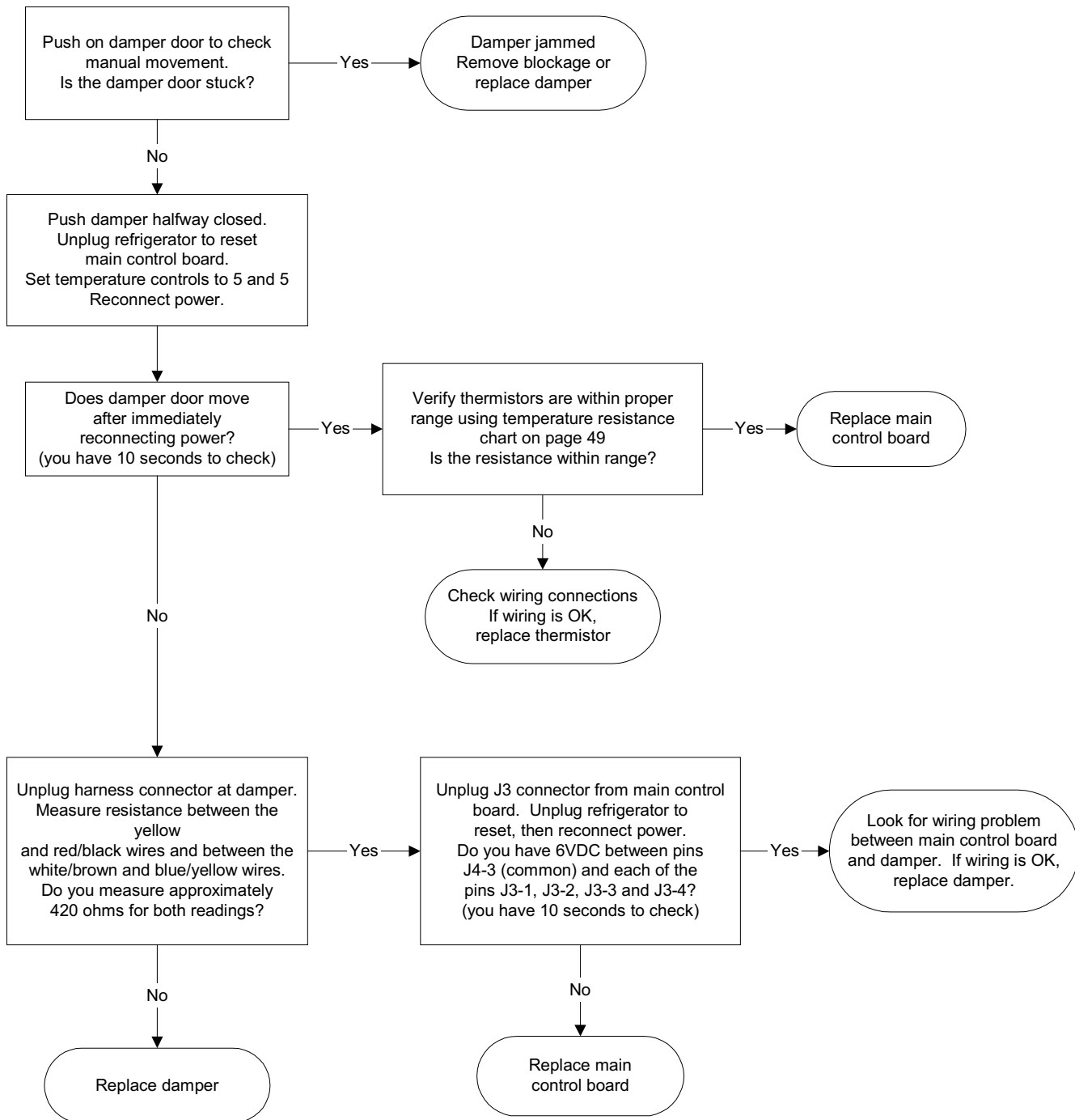

Compressor Not Running

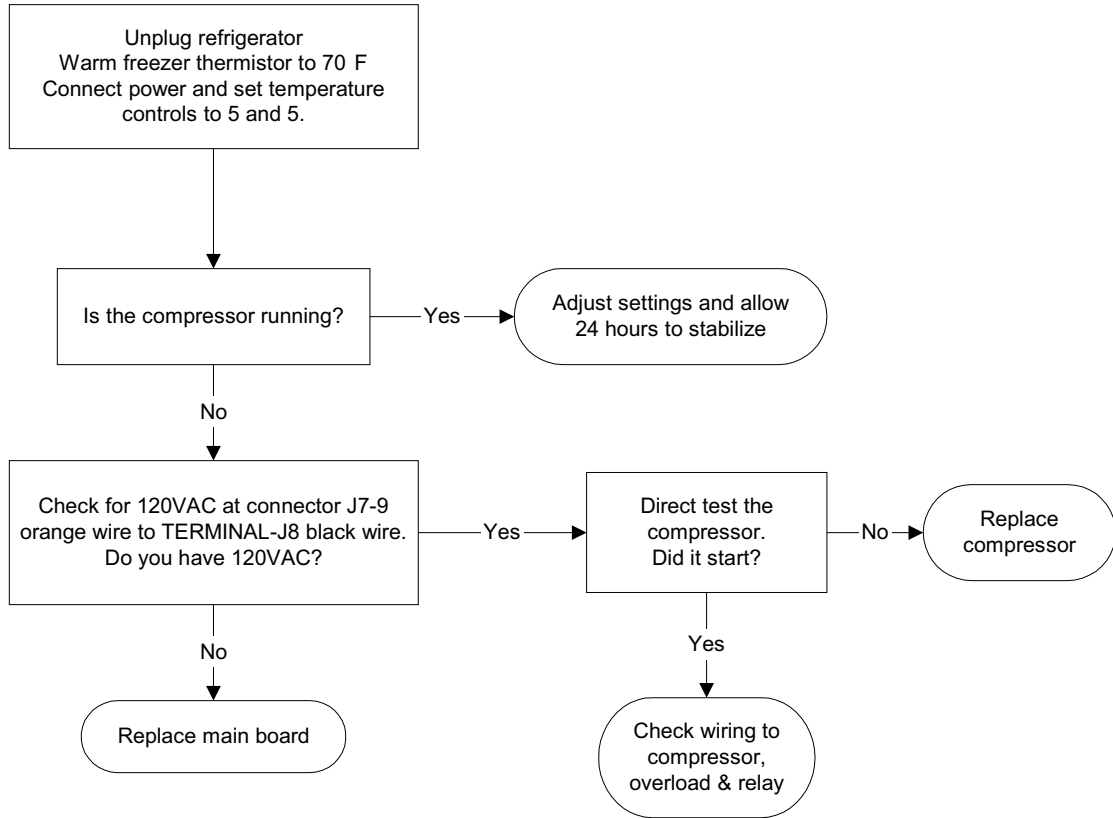

Heavy Frost on Evaporator

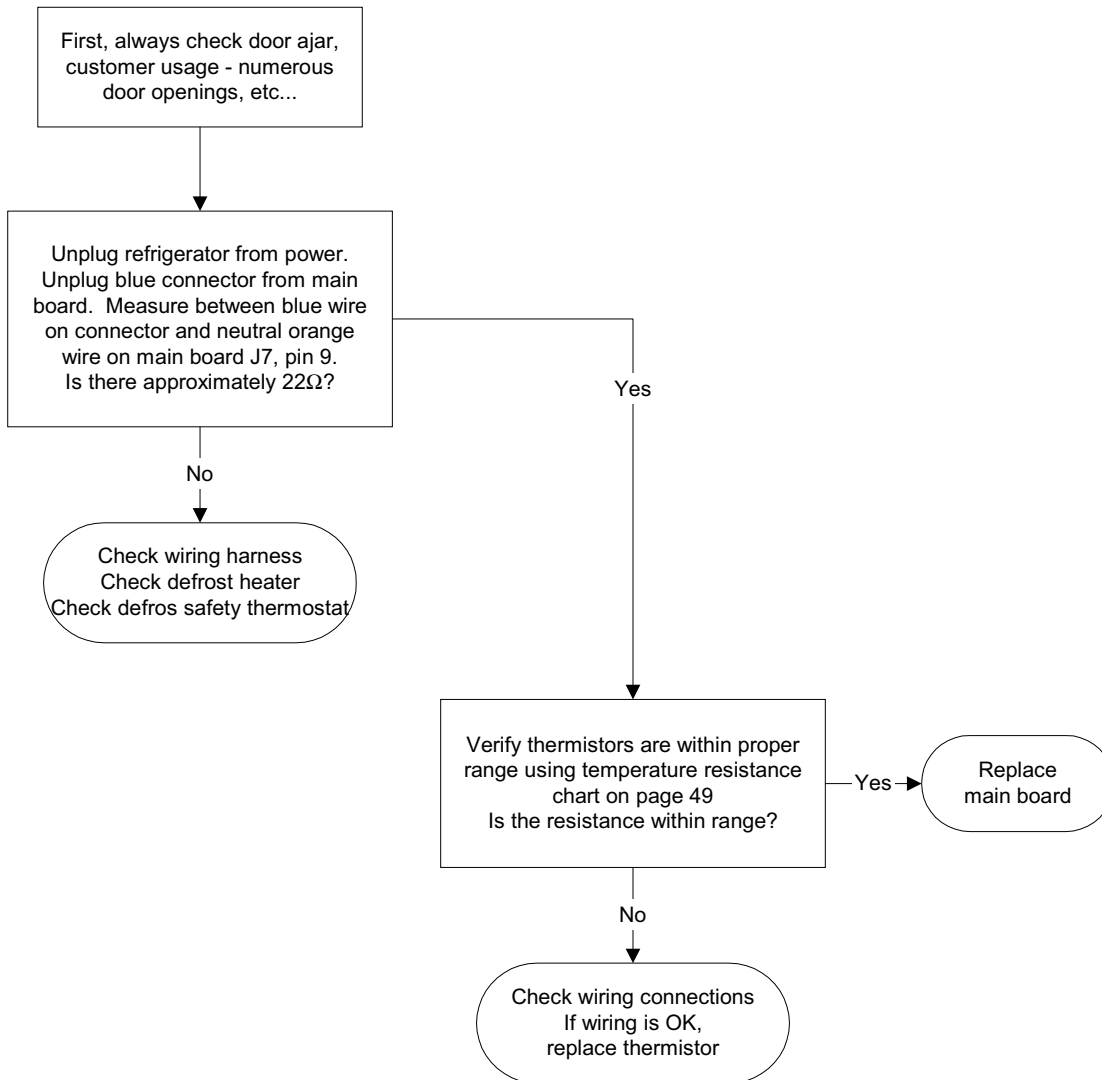
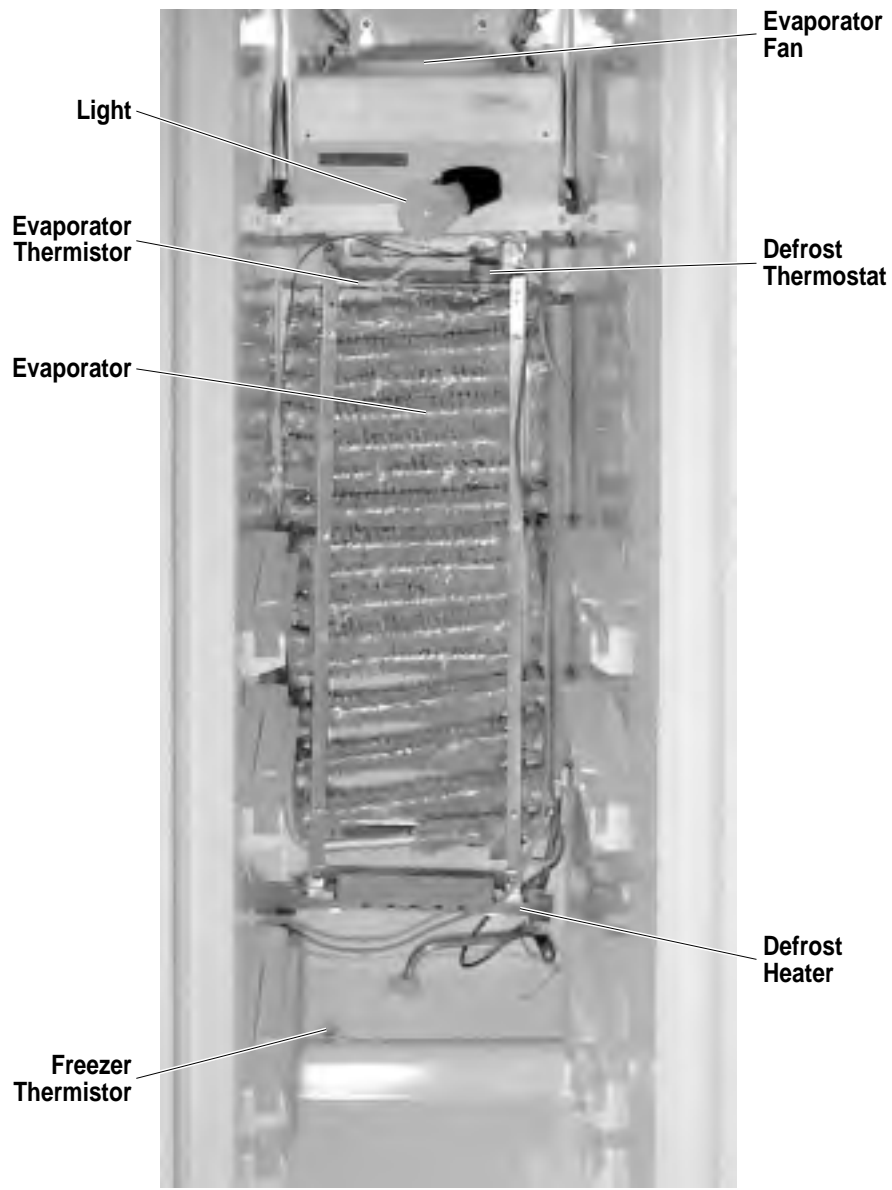

Table 2. Thermistor Values		
Temperature Degrees (C)	Temperature Degrees (F)	Resistance in Kilo-Ohms
-40	-40	166.8 kΩ
-35	-31	120.5 kΩ
-30	-22	88 kΩ
-25	-13	65 kΩ
-20	-4	48.4 kΩ
-15	5	36.4 kΩ
-10	14	27.6 kΩ
-5	23	21 kΩ
0	32	16.3 kΩ
5	41	12.7 kΩ
10	50	10 kΩ
15	59	7.8 kΩ
20	68	6.2 kΩ
25	77	5 kΩ
30	86	4 kΩ
35	95	3.2 kΩ
40	104	2.6 kΩ
45	113	2.2 kΩ
50	122	1.8 kΩ
55	131	1.5 kΩ
60	140	1.2 kΩ

NOTE: The thermistor's resistance has a negative coefficient. As the temperature increases, the thermistor's resistance decreases.

Component and Connector Locator Views





GEA00913

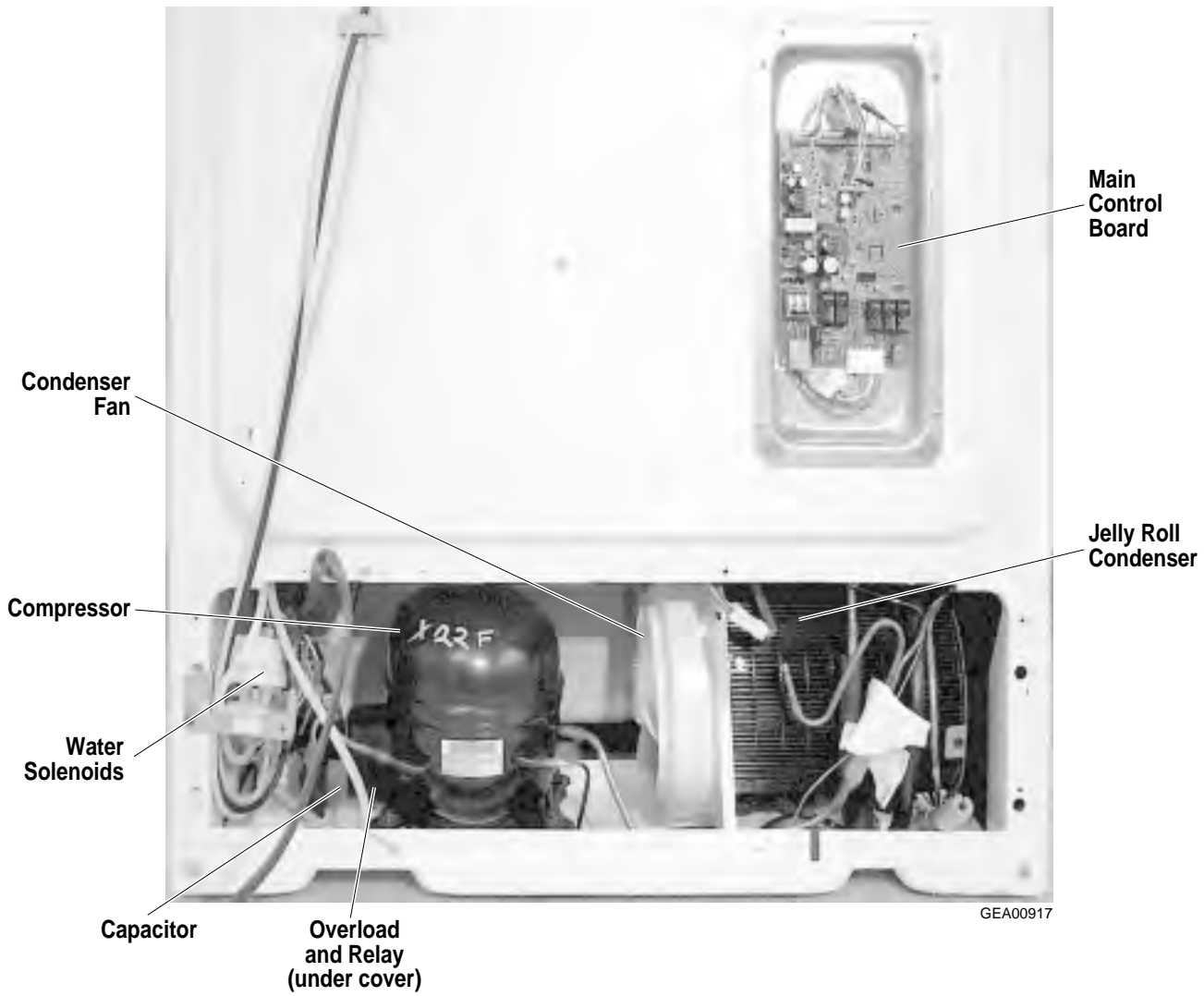

Main Control Board (120 VAC Side)

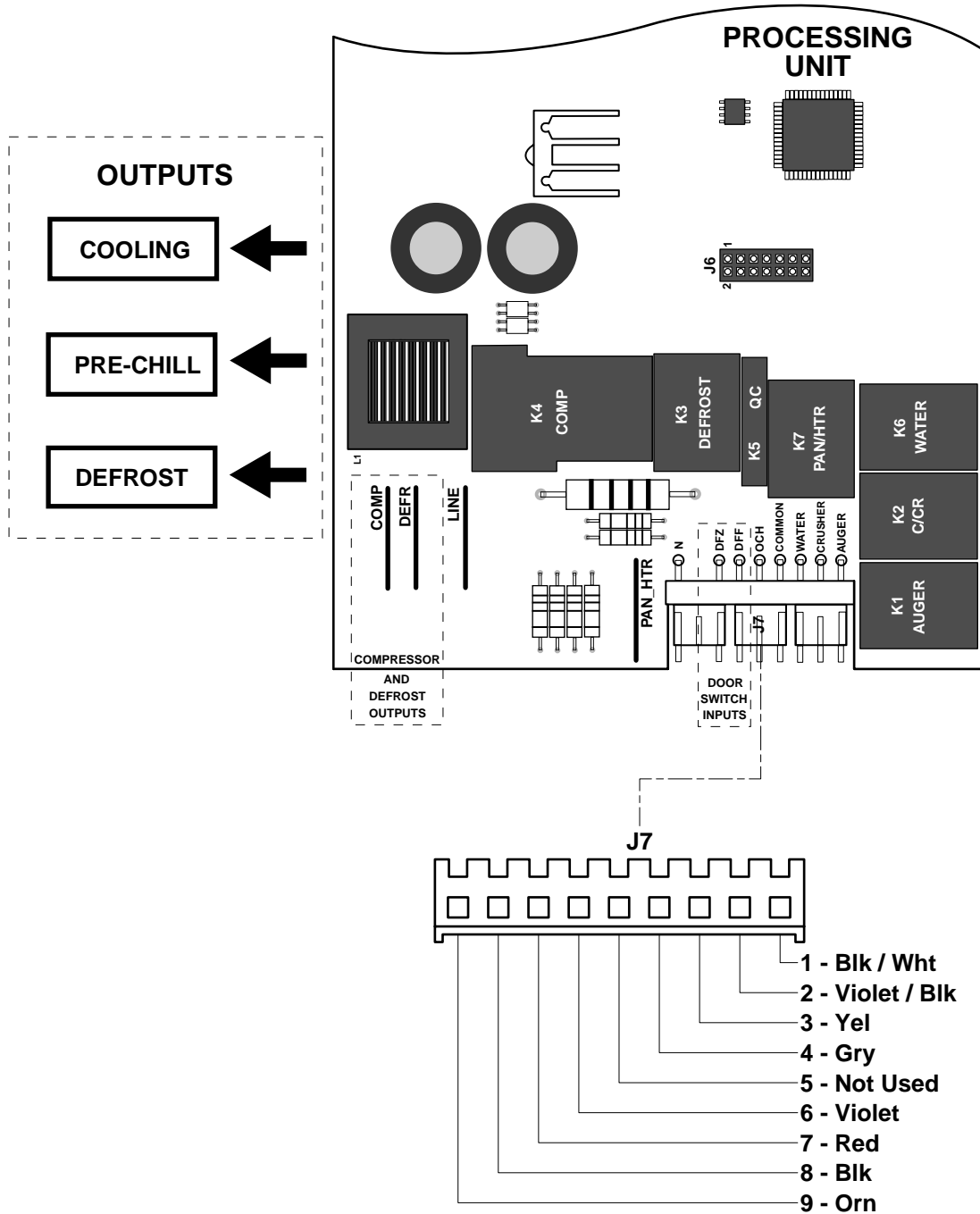

GEA00905

NOTE: Refer to the Main Control Board Locator Tables in the Diagnostics chapter for more information.

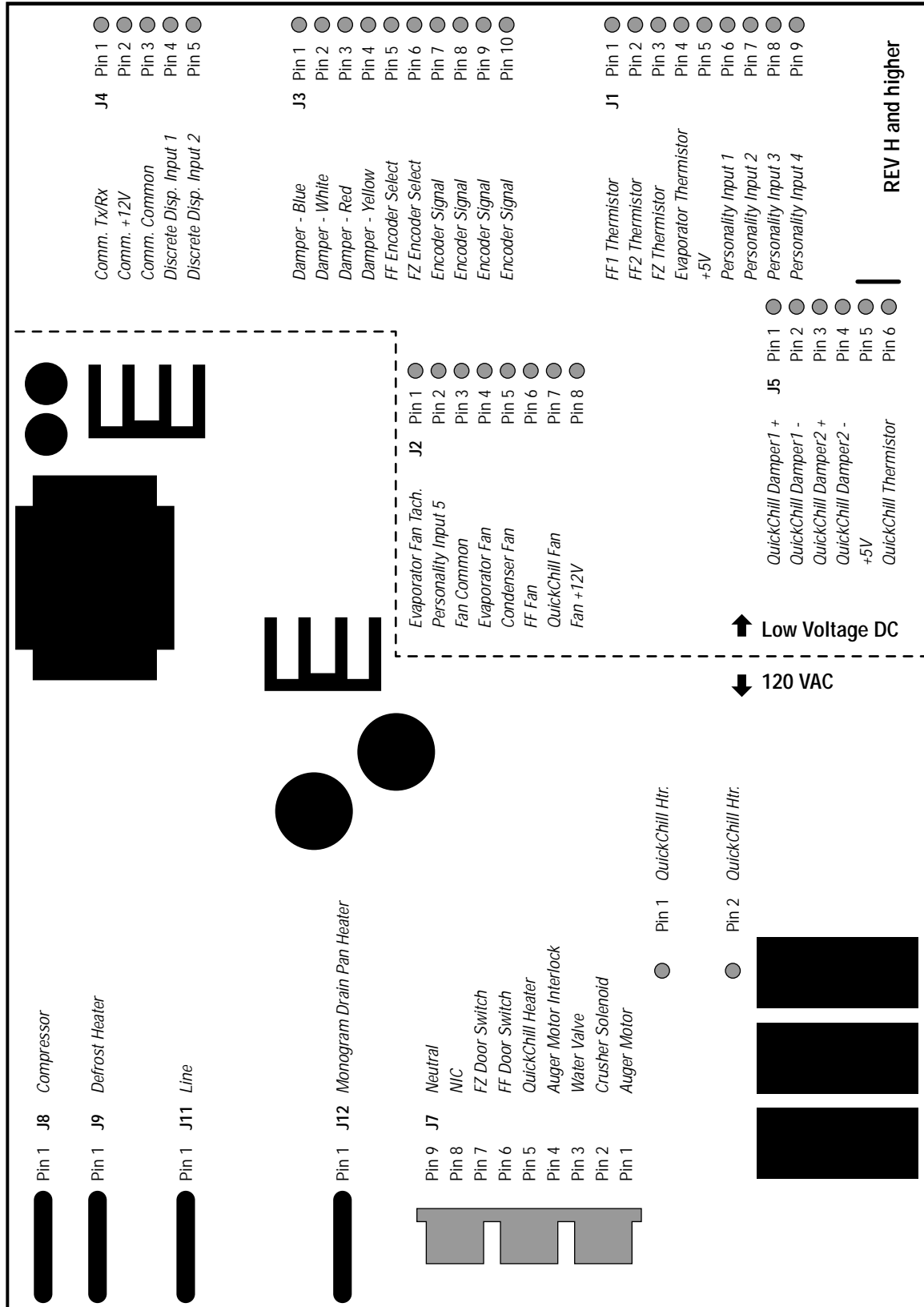

Illustrated Parts Catalog

MODELS

GSS25KGMAAA

GSS25KGMABB

GSS25KGMACC

GSS25KGMWW

FREEZER SECTION

Exploded parts views and list is for illustration only. Refer to microfiche for specific model information.

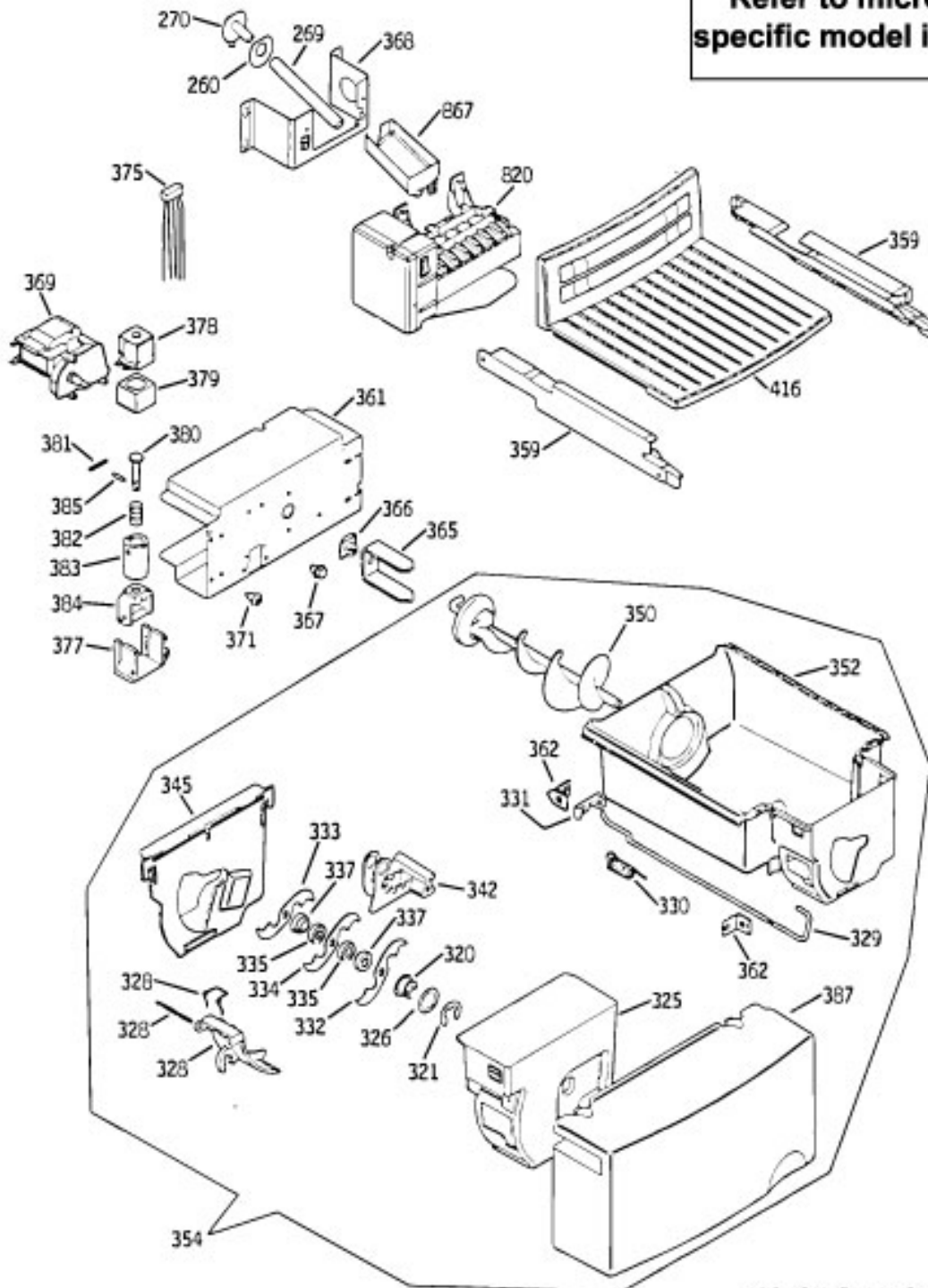

(ART NO. WR1B7B2 C)

G G G G
 S S S S
 S S S S
 2 2 2 2
 5 5 5 5
 K K K K
 G G G G
 M M M M
 A A A A
 A B C W
 A B C W

REF. NO.	PART NO.	PART DESCRIPTION				
00260	WR02X9223	GASKET DONUT	1	1	1	1
00269	WR02X7927	TUBE WATER FILL	1	1	1	1
00270	WR02X10564	GROMMET WATER FILL	1	1	1	1
00320	WR01X10189	NUT AUGER FRT DISP	1	1	1	1
00321	WR01X1367	RETAINER RING E	1	1	1	1
00325	WR17X10717	HOUSING CRUSHER DISP	1	1	1	1
00326	WR01X1366	WASHER	1	1	1	1
00328	WR02X4143	PIN DEFLECTOR DISP	1	1	1	1
	WR02X4561	SPRING ICE DEFLECTOR	1	1	1	1
	WR17X10703	DEFLECTOR ICE DISP	1	1	1	1
00329	WR17X10735	WIRE ACTUATOR DISP	1	1	1	1
00330	WR02X10583	SPRING DEFLECTOR	1	1	1	1
00331	WR02X10580	RETAINER SPRING	1	1	1	1
00332	WR17X1361	BLADES MOVING DISP	1	1	1	1
00333	WR17X1362	BLADES MOVING DISP	1	1	1	1
00334	WR17X1363	BLADES MOVING DISP	1	1	1	1
00335	WR02X4139	SPACER	2	2	2	2
00337	WR02X4138	SPACER CRUSHER STATIONAR	2	2	2	2
00342	WR02X10691	STATIONARY BLADES ASM	1	1	1	1
00345	WR17X10699	COVER CRUSHER HSG DISP	1	1	1	1
00350	WR17X10690	AUGER ASM DISP	1	1	1	1
00352	WR30X10016	BUCKET ICE DISP	1	1	1	1
00354	WR17X10778	BUCKET & AUGER ASM	1	1	1	1
00359	WR72X10047	GLIDE BUCKET LH DISP	1	1	1	1
	WR72X10048	GLIDE BUCKET RH DISP	1	1	1	1
00361	WR17X10788	COVER MOTOR & SOLENOID	1	1	1	1
00362	WR02X8839	BRACKET SHELF	2	2	2	2
00365	WR02X10565	DRIVE AUGER DISP	1	1	1	1
00366	WR01X10190	NUT J	1	1	1	1
00367	WR01X10198	SCR 8-18 TPT 1/4	5	5	5	5
00368	WR02X10543	BRACKET IM MOUNTING	1	1	1	1
00369	WR60X10056	MOTOR CRUSHER DISP	1	1	1	1
00371	WR01X10192	SCR 10-18 HI/LO HXW 1/2	2	2	2	2
00375	WR23X10157	HARNESS MOTOR DISP	1	1	1	1
00377	WR02X7309	SADDLE SOLENOID	1	1	1	1
00378	WR62X0058	SOLENOID ARM ASM	1	1	1	1
00379	WR17X1063	SHROUD SOLENOID	1	1	1	1
00380	WR17X1064	PLUNGER SOLENOID	1	1	1	1
00381	WR02X4257	PIN SPIRAL	1	1	1	1
00382	WR02X4258	SPRING SOLENOID LINKAGE	1	1	1	1
00383	WR17X1065	COLLAR SOLENOID DISP	1	1	1	1
00384	WR17X1066	STIRRUP SOLENOID DISP	1	1	1	1
00385	WR02X4259	PIN SPIRAL	1	1	1	1
00387	WR17X10779	COVER BUCKET DISP	1	1	1	1
00416	WR71X10228	SHELF CHILLER	1	1	1	1

G	G	G	G
S	S	S	S
S	S	S	S
2	2	2	2
5	5	5	5
K	K	K	K
G	G	G	G
M	M	M	M
A	A	A	A
A	B	C	W
A	B	C	W

REF. NO.	PART NO.	PART DESCRIPTION				
00820	WR30X10012	ELECTRONIC IM-DOM	1	1	1	1
00867	WR29X10042	CUP FILL IM	1	1	1	1

MODELS

GSS25KGMAAA

GSS25KGMABB

GSS25KGMACC

GSS25KGMAWW

FREEZER SHELVES

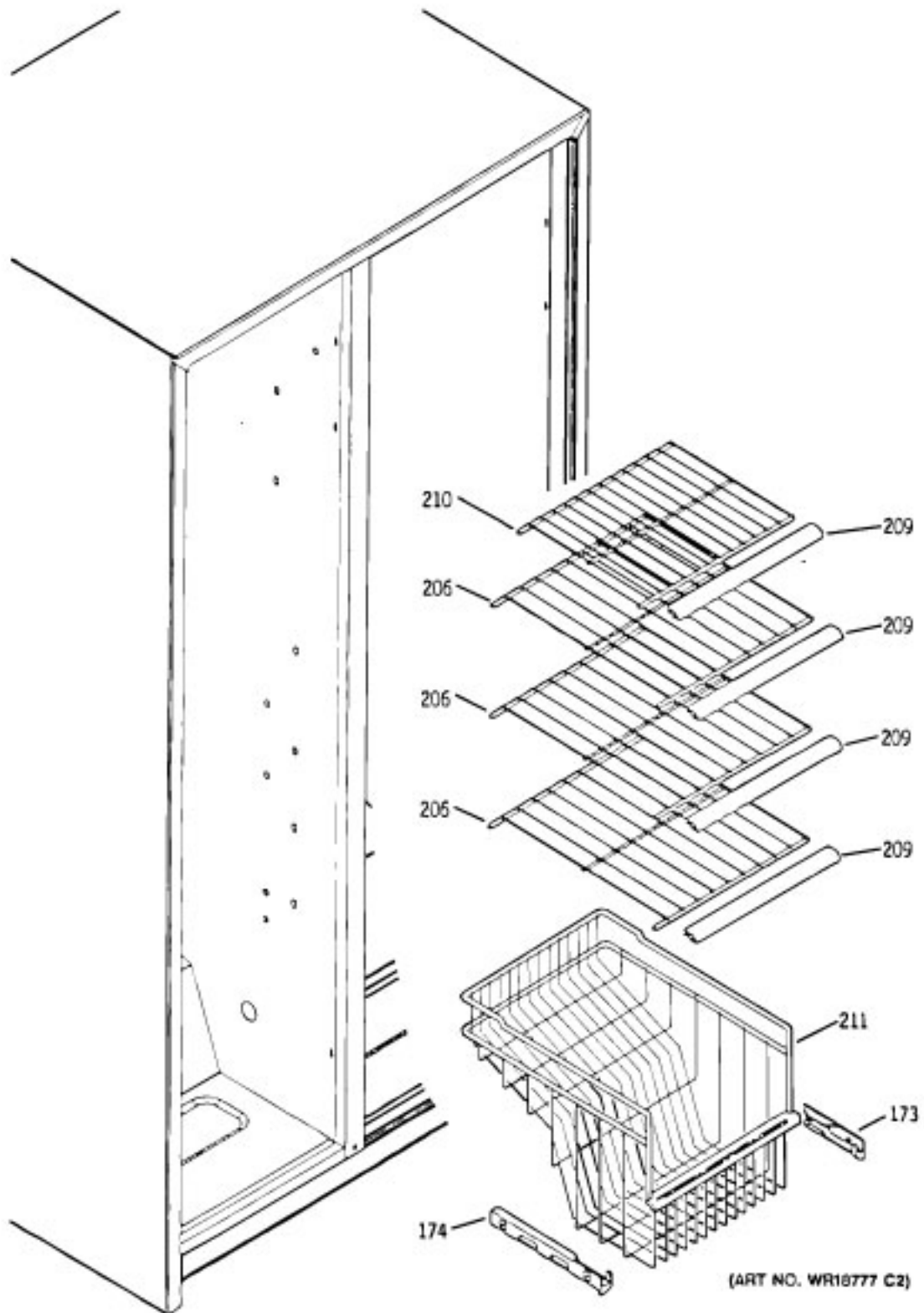

G	G	G	G
S	S	S	S
S	S	S	S
2	2	2	2
5	5	5	5
K	K	K	K
G	G	G	G
M	M	M	M
A	A	A	A
A	B	C	W
A	B	C	W

REF. NO.	PART NO.	PART DESCRIPTION				
00173	WR02X8724	SUPPORT SLIDE BASKET RH	1	1	1	1
00174	WR02X8667	SUPPORT SLIDE BASKET LH	1	1	1	1
00206	WR71X1936	SHELF FZ	3	3	3	3
00209	WR38X10200	TRIM SHELF WIRE FZ	4	4	4	4
00210	WR71X10230	SHELF FZ 3/4	1	1	1	1
00211	WR21X10021	BIN WIRE SLIDEOUT FZ	1	1	1	1

MODELS

GSS25KGMAAA

GSS25KGMABB

GSS25KGMACC

GSS25KGMWW

FREEZER SECTION

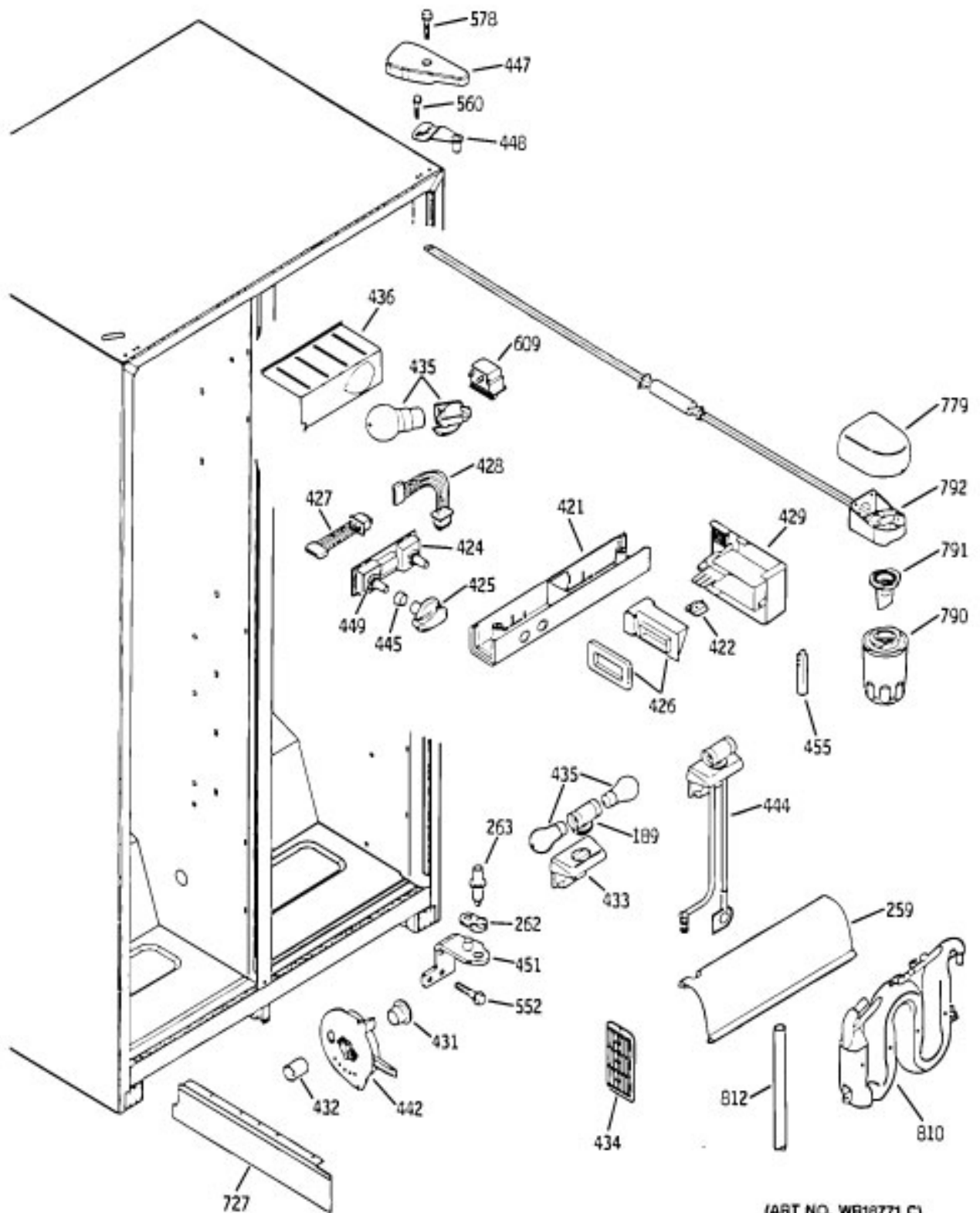

(ART NO. WR18771 C)

G	G	G	G
S	S	S	S
S	S	S	S
2	2	2	2
5	5	5	5
K	K	K	K
G	G	G	G
M	M	M	M
A	A	A	A
A	B	C	W
A	B	C	W

REF. NO.	PART NO.	PART DESCRIPTION				
00189	WR02X9243	SOCKET LIGHT	1	1	1	1
00259	WR17X10725	SHIELD LIGHT LOWER	1	1	1	1
00262	WR02X10568	HINGE CAM RISER	2	2	2	2
00263	WR02X10592	PIN HINGE BTM ADJ	1	1	1	1
00421	WR14X10044	GASKET CONTROL HOUSING	2	2	2	2
	WR17X10716	HOUSING CONTROL	1	1	1	1
00422	WR02X10546	CLIP DAMPER COVER	2	2	2	2
00424	WR55X10040	BOARD ASM ENCODER	1	1	1	1
00425	WR02X10570	KNOB CONTROL	2	2	2	2
00426	WR09X10050	DAMPER & GASKET ASM	1	1	1	1
	WR14X10047	GASKET DAMPER	1	1	1	1
00427	WR23X10165	HARNESS CONTROL TOP	1	1	1	1
00428	WR23X10156	HARNESS LT & SW	1	1	1	1
00429	WR02X10618	COVER DAMPER	1	1	1	1
00431	WR02X9299	CAP MULLION DUCT	1	1	1	1
00432	WR02X10561	DUCT MULLION	1	1	1	1
00433	WR02X9239	HOUSING LAMP SOCKET	1	1	1	1
00434	WR17X10262	GRILLE AIR RETURN	1	1	1	1
00435	60A	LAMP 60W APPL	2	2	2	2
	STD372402	LAMP 40W 120V	2	2	2	2
	WR02X10591	SOCKET & TERMINAL	2	2	2	2
00436	WR02X10578	REFLECTOR LAMP	1	1	1	1
00442	WR17X10060	CONTROL MEAT PAN ASM	1	1	1	1
00444	WR23X10159	HOUSING LIGHT LWR ASM	1	1	1	1
00445	WR02X10581	RING COMPRESSION	2	2	2	2
00447	WR02X10555	COVER HINGE WH	-	-	-	2
	WR02X10600	COVER HINGE AD	2	-	-	-
	WR02X10609	COVER HINGE BK	-	2	-	-
	WR02X10614	COVER HINGE BQ	-	-	2	-
00448	WR13X10122	HINGE TOP ASM FF	1	1	1	1
00449	WR01X10191	NUT SPECIAL	2	2	2	2
00451	WR13X10119	HINGE BTM & PIN ASM	1	1	1	1
00455	WR02X10622	COVER SENSOR FF	1	1	1	1
00552	WR01X10034	SCR 12-24 TT IH .975 S	4	4	4	4
00560	WR01X10195	SCR 12-24 CA HX 7/8 S	4	4	4	4
00578	WZ02X0503	SCR 8-32 MA PA 3/8 S	2	2	2	2
00609	WR23X10162	SWITCH LIGHT	1	1	1	1
00727	WR17X10723	SEPARATOR AIR HISIDE	1	1	1	1
00779	WR02X10557	COVER WATER FILTER	1	1	1	1
00790	GWF	FILTER CANISTER	1	1	1	1
00791	WR02X10577	PLUG BYPASS FILTER	1	1	1	1
00792	WR17X10707	FILTER ASM AND TUBE	1	1	1	1
00810	WR17X10734	WATER TANK DISP ASM	1	1	1	1
00812	WR17X10732	TUBE PLASTIC	1	1	1	1

FRESH FOOD SHELVES

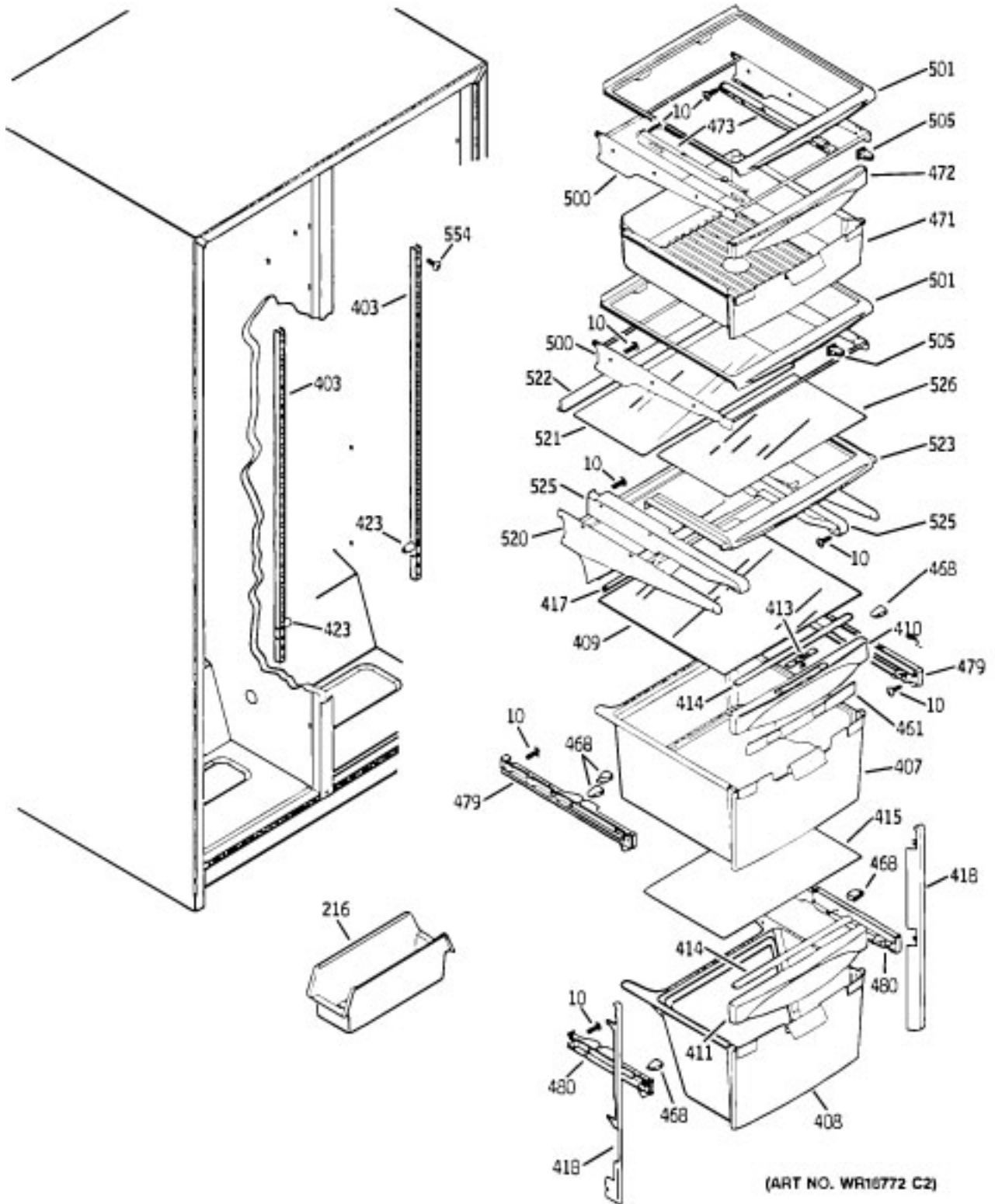

(ART NO. WR16772 C2)

G G G G
 S S S S
 S S S S
 2 2 2 2
 5 5 5 5
 K K K K
 G G G G
 M M M M
 A A A A
 A B C W
 A B C W

REF. NO.	PART NO.	PART DESCRIPTION				
00010	WR01X10065	SCR 8-18 BA POR 5/8 SS	10	10	10	10
00216	WR32X1575	BUCKET UTILITY CLR	1	1	1	1
00403	WR72X0254	TRACK CANT SHELF	2	2	2	2
00407	WR32X10133	PAN VEG	1	1	1	1
00408	WR32X10131	PAN MEAT	1	1	1	1
00409	WR32X10130	COVER PAN GLASS	1	1	1	1
00410	WR17X10715	HANDLE VEG PAN	1	1	1	1
00411	WR17X10713	HANDLE PAN MEAT	1	1	1	1
00413	WR02X10544	BUTTON SLIDE	1	1	1	1
00414	WR14X10051	GASKET PAN COVER FRT	2	2	2	2
00415	WR32X10129	COVER PAN GLASS	1	1	1	1
00417	WR14X10052	GASKET SHIELD LOWER	1	1	1	1
00418	WR17X10729	TRIM PAN LH	1	1	1	1
	WR17X10730	TRIM PAN RH	1	1	1	1
00423	WR02X6347	SUPPORT SHIELD TOP	2	2	2	2
00461	WR72X10049	SLIDE PAN	1	1	1	1
	WZ06X0136	SCR 8-18 AB HXW 1/2 S	1	1	1	1
00468	WR01X2048	BEARING SLIDE LH	8	8	8	8
00471	WR32X10132	PAN SNACK UPPER	1	1	1	1
00472	WR17X10714	HANDLE PAN SNACK	1	1	1	1
	WR17X10827	HANDLE PAN SNACK	1	1	1	1
00473	WR72X0210	SLIDE PAN RH	1	1	1	1
	WR72X0211	SLIDE PAN LH	1	1	1	1
00479	WR72X0239	SLIDE ASM LH	1	1	1	1
	WR72X0240	SLIDE ASM RH	1	1	1	1
00480	WR72X0241	SLIDE ASM LH	1	1	1	1
	WR72X0242	SLIDE ASM RH	1	1	1	1
00500	WR71X10226	SHELF CANT SPILLPRF	2	2	2	2
00501	WR32X10134	SHELF ENCAP SLIDEOUT	2	2	2	2
00505	WR01X2080	STOP SHELF	4	4	4	4
00520	WR71X10227	SHELF CANT TUCKAWAY	1	1	1	1
00521	WR32X10136	SHELF GLASS TUCKAWAY	1	1	1	1
00522	WR36X10198	REFLECTOR TUCKAWAY	1	1	1	1
00523	WR71X10229	SHELF FRAME TUCKAWAY	1	1	1	1
00525	WR72X10050	SLIDE TUCKAWAY LH	1	1	1	1
	WR72X10051	SLIDE TUCKAWAY RH	1	1	1	1
00526	WR32X10135	SHELF GLASS TUCKAWAY	1	1	1	1
00554	WR01X2141	SCR 10-24 TR HXW I S	6	6	6	6

G G G G
 S S S S
 S S S S
 2 2 2 2
 5 5 5 5
 K K K K
 G G G G
 M M M M
 A A A A
 A B C W
 A B C W

REF. NO.	PART NO.	PART DESCRIPTION				
00226	WR02X10558	CLIP DRAIN TUBE	1	1	1	1
00257	WR02X10586	STANDOFF CIRCUIT BOARD	4	4	4	4
00260	WR02X9223	GASKET DONUT	1	1	1	1
00269	WR02X7927	TUBE WATER FILL	1	1	1	1
00270	WR02X10564	GROMMET WATER FILL	1	1	1	1
00312	WR02X10571	MOBILITY BACK ASM	2	2	2	2
00614	WR02X10540	BUMPER LID	4	4	4	4
00616	WR82X10071	COVER ACCESS ASM	1	1	1	1
00618	WR02X10520	GROMMET EVAP/COND FAN	2	2	2	2
00626	WR23X0108	POWER CORD	1	1	1	1
00627	WR17X10691	BAFFLE CONDENSER	1	1	1	1
00628	WR17X10726	SHROUD CONDENSER	1	1	1	1
00630	WR02X4097	PLUG BUTTON WH	4	4	4	4
00650	WR60X10053	MOTOR DC COND FAN	1	1	1	1
00651	WR60X10049	BLADE COND FAN ASM	1	1	1	1
00652	WR02X10509	RING COMPRESSION	2	2	2	2
00683	WR02X10562	FASTENER PUSH	3	3	3	3
00686	WR01X10194	SCR 10-32 TT HXW 5/16 S	4	4	4	4
00690	WR01X1466	SCR 8-32 T HXW 3/8 S	6	6	6	6
00691	WR02X10593	BRACKET COND FAN (REAR)	1	1	1	1
00725	WR87X10041	COMP REPL KIT	1	1	1	1
00726	WR02X10545	CLIP- CAP TUBE	1	1	1	1
00728	WR14X10055	GROMMET TUBING SLIT	2	2	2	2
00729	WR62X0080	CAPACITOR	1	1	1	1
00730	WR84X10022	CONDENSER ASM	1	1	1	1
00733	WR07X10033	PTCR	1	1	1	1
00734	WR02X10556	COVER RELAY SNAP (MEI)	1	1	1	1
00735	WR08X10026	OVERLOAD	1	1	1	1
00736	WR02X8203	CLIP COMPRESSOR MOUNT	4	4	4	4
00737	WR02X10099	GROMMET	4	4	4	4
00740	WR86X0096	DRYER BIFURCATED XH9	1	1	1	1
00741	WR01X1779	STUD MTG COMPR	4	4	4	4
00742	WR02X10587	SUPPORT CONDENSER	1	1	1	1
00743	WR02X10588	SUPPORT CONDENSER	1	1	1	1
00747	WR82X10073	INSULATION SIDE	1	1	1	1
00749	WR17X10694	BAFFLE COND AIR	1	1	1	1
00750	WR01X1786	SCR 10-32 TR T 1/2	4	4	4	4
00751	WR17X10693	BASEPLATE HIGH SIDE	1	1	1	1
00752	WR82X10072	INSULATION MACHINE TOP	1	1	1	1
00753	WR02X10521	BRACKET COND FAN (MTG)	1	1	1	1
00757	WR01X10193	SCR 10-32 SPECIAL	4	4	4	4
00762	WR14X10053	FOAM STRIP SE ADH	1	1	1	1
00764	WR02X9000	CLIP, CONDENSER MOUNT	2	2	2	2
00765	WR17X10695	BRACKET CONDENSER BAR	1	1	1	1
00775	WR02X10047	COVER WATER LINE	1	1	1	1