

GE Consumer & Industrial

# Technical Service Guide

February 2006

## GE Profile™ Dishwasher

PDW8900 Series

PDW9700 Series

PDW9900 Series

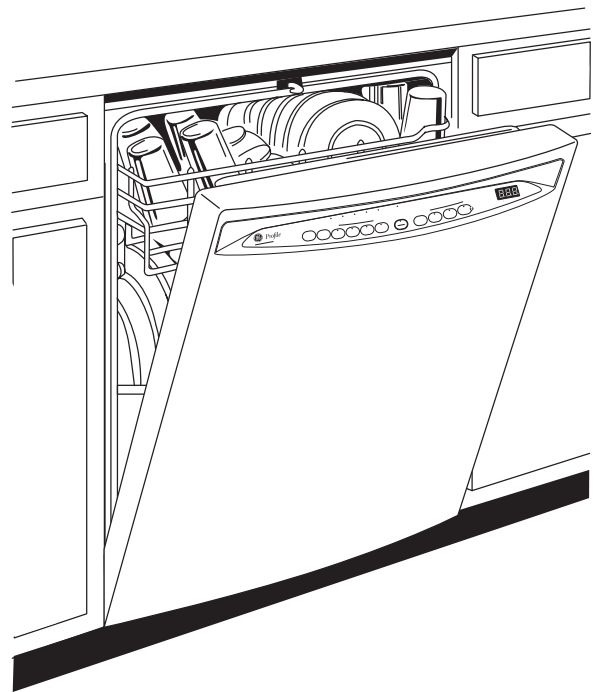

31-9137



GE Appliances  
General Electric Company  
Louisville, Kentucky 40225



## **IMPORTANT SAFETY NOTICE**

The information in this service guide is intended for use by individuals possessing adequate backgrounds of electrical, electronic, and mechanical experience. Any attempt to repair a major appliance may result in personal injury and property damage. The manufacturer or seller cannot be responsible for the interpretation of this information, nor can it assume any liability in connection with its use.

### **WARNING**

To avoid personal injury, disconnect power before servicing this product. If electrical power is required for diagnosis or test purposes, disconnect the power immediately after performing the necessary checks.

### **RECONNECT ALL GROUNDING DEVICES**

If grounding wires, screws, straps, clips, nuts, or washers used to complete a path to ground are removed for service, they must be returned to their original position and properly fastened.

***GE Consumer & Industrial***

*Technical Service Guide*

*Copyright © 2006*

All rights reserved. This service guide may not be reproduced in whole or in part in any form without written permission from the General Electric Company.

# Table of Contents

Active Vent.....	28
Circulation Pump and Motor .....	30
Component Locator Views.....	10
Control Features.....	6
Control Module.....	27
Customer Purge of the Bulk Dispenser Tank .....	18
Demo Mode .....	26
Detergent/Rinse Module.....	19
Dishwasher Components.....	12
Door Interlock Switch.....	19
Door Panel.....	12
Door Spring Installation.....	31
Drain System .....	24
Factory Test Mode.....	33
Factory Test Mode.....	33
Fan (PDW9700 and PDW9900 Series).....	28
Fill Funnel.....	21
Heating Element.....	22
Introduction.....	5
Keypad Assembly.....	13
Lower Spray Arm, Fine Filter, and Inlet Cover.....	21
Main Conduit.....	21
Middle Spray Arm .....	20
Nomenclature.....	4
Schematics and Strip Circuits .....	34
Service Mode .....	32
Single Rack Wash™ .....	29
SmartDispense™ .....	15
Smart Fill System.....	24
Turbidity Sensor .....	23
Upper Spray Arm.....	21
Using the Dishwasher with the Upper Rack Removed.....	20
Warranty for 2005 Product.....	36
Warranty for 2006 and Later Product.....	37
Wash Cycles.....	26
Water Hardness Test and Calibration.....	14
Water Valve and Flood Switch.....	25
Water Valve Test .....	25
Wax Motor and Magnet .....	30

# Nomenclature

## Model Number

**P D W 9 9 8 0 L 0 0 S S**

### Brand

P = Profile  
 E = General Electric - NATM  
 G = General Electric

### Product Type

CD = Counter Top      DW = Dishwasher  
 SD = Standard        SC = Convertible  
 SM = Spacemaker      SS = Compact (18 in.)  
 RF = Retrofit         HD = Home Depot Derivative

### Model Designator

Designates features - the higher the number, the more features.

### Exterior Color

BB = Black  
 II = Requires Custom Panel and Handle  
 SS = Stainless Steel  
 WW = White

### Engineering Model Suffix

### Model Year Designator

## Nomenclature

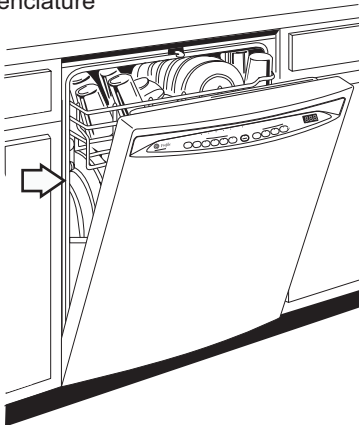

The serial plate of your dishwasher is located on the tub wall just inside the door jam.

The mini-manual is located behind the toe plate.

## Serial Number

The first two characters of the serial number identify the month and year of manufacture.  
 Example: **AL**123456S = January, 2006

<b>A</b> - JAN	2006 - <b>L</b>
<b>D</b> - FEB	2005 - <b>H</b>
<b>F</b> - MAR	2004 - <b>G</b>
<b>G</b> - APR	2003 - <b>F</b>
<b>H</b> - MAY	2002 - <b>D</b>
<b>L</b> - JUN	2001 - <b>A</b>
<b>M</b> - JUL	2000 - <b>Z</b>
<b>R</b> - AUG	1999 - <b>V</b>
<b>S</b> - SEP	1998 - <b>T</b>
<b>T</b> - OCT	1997 - <b>S</b>
<b>V</b> - NOV	1996 - <b>R</b>
<b>Z</b> - DEC	1995 - <b>M</b>

The letter designating the year repeats every 12 years.

Example:

T - 1974  
 T - 1986  
 T - 1998

# Introduction



The new GE Profile PDW8900 Series, PWDW9700 Series, and PDW9900 Series dishwashers incorporate the following new features for 2005:

- **SmartDispense™** - A bulk liquid detergent dispense assembly is introduced with this dishwasher. It consists of a dispense reservoir mounted within the inner door panel, a liquid level sensor connected to a Low Detergent LED on the control panel, and a positive displacement pump to inject the optimal amount of detergent into the dishwasher during each cycle. A water hardness selection mode permits the calibration of the location's water hardness.
- **Single Rack Wash™** - In addition to the two rack wash cycles, this GE Profile dishwasher has a Single Rack Wash which bypasses the lower spray arm, directing the cleaning power to the upper rack only. Water is dispensed from the middle and upper wash arms only.
- **Smart Fill** - The wash system has been changed to a low flow design. The wash, dry, and noise performance have all been improved. Smaller jets on the spray arms require less water to keep the pump primed. Less water allows the Calrod to heat the water to a higher temperature, improving both wash and dry performances.
- **Angled Rack Dry** - A new top rack features two adjustable-angle dividers. This prevents rinse water from puddling, allowing it to run off the bottoms of stemware, glasses, and cups.

# Control Features

Throughout this manual, features and appearance may vary from your model.

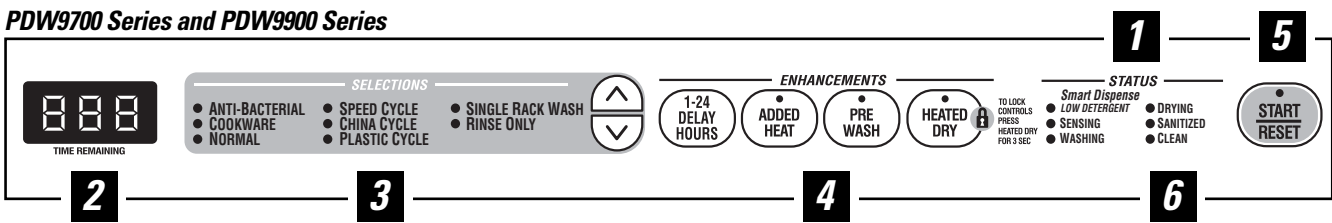
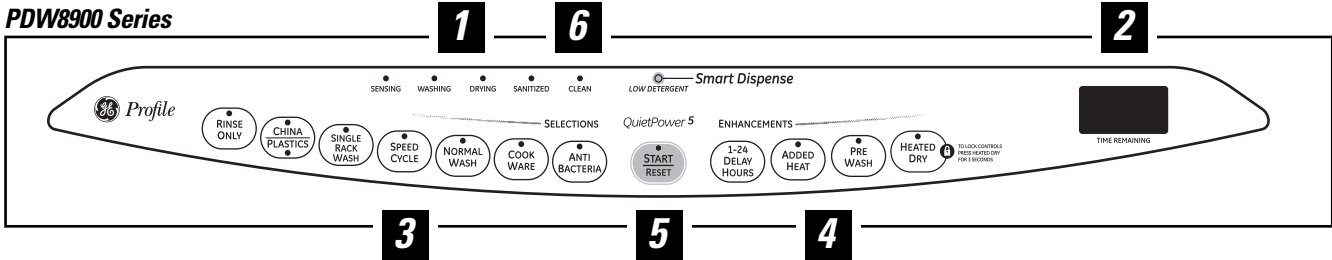

## Control Settings

### 1 Status Indicator Lights (Indicators vary by models)

The Status display tells you what is happening while the dishwasher is in operation and may flash, indicating a malfunction. The lights will come **ON** indicating the sequence of the dishwasher operation.

**LOW DETERGENT** Displayed when the SmartDispense needs to be refilled with liquid or gel automatic dishwasher detergent.

**SENSING** Displayed while the Clean Sensor™ is measuring the amount of soil and temperature of water. The dishwasher will adjust the selected cycle to achieve optimal performance.

**WASHING** Displayed during prewash, main wash and rinse periods.

**DRYING** Displayed during **HEATED DRY**.

**SANITIZED** Displayed when cycle has met sanitization conditions.

**CLEAN** Displayed when a wash cycle is complete.

### 2 Time Remaining Display (on some models)

During operation, the display shows the minutes remaining until the cycle is complete. The display may adjust the remaining time while the Sensing light is on. The time displayed at the start of each cycle may change from the factory setting as the unit customizes itself to home use. During a delay start, the display will show hours of time remaining until the cycle starts.

### 3 Selections

PDW8900 Series: Press the pad for the desired wash cycle.

PDW9700 and PDW9900 Series: Use the Arrow Pads   to scroll through the wash cycles.

**NOTE:** All cycle times and water usage information contained in the following section are approximate values only. Actual results will depend on several factors, including but not limited to, inlet temperature, household water pressure, and turbidity of the wash water.

The light above or next to the selected pad will be **ON** to indicate which **WASH CYCLE** has been selected.

---

**ANTI-BACTERIA** **Heavy** 7.8 gal., 105 min.  
**Medium** 6.7 gal., 95 min.  
**Light** 5.6 gal., 85 min.

This cycle raises the water temperature in the final rinse to sanitize your dishware. The cycle length will vary depending on the temperature of your inlet water.

**NOTE:** The Anti-Bacteria cycle is monitored for sanitization requirements. If the cycle is interrupted during or after the main wash portion or if the incoming water temperature is so low that adequate water heating cannot be achieved, the sanitizing conditions may not be met. In these cases, the sanitized light will not illuminate at the end of the cycle.

**NOTE:** NSF-certified residential dishwashers are not intended for licensed food establishments.

---

**COOKWARE (POTS & PANS)** **Heavy** 8.9 gal., 80 min.  
**Medium** 7.8 gal., 70 min.  
**Light** 6.7 gal., 60 min.

This cycle is meant for heavily soiled dishes or cookware with dried-on or baked-on soils. This cycle may not remove burned-on foods. Everyday dishes are safe to be used in this cycle.

---

**NORMAL WASH** **Heavy** 7.8 gal., 75 min.  
**Medium** 6.7 gal., 65 min.  
**Light** 4.5 gal., 50 min.

This cycle is for medium/heavily soiled dishes and glassware.

---

**SPEED CYCLE** 6.7 gal., 35 min.

This cycle is for everyday dishes and glassware.

---

**CHINA CRYSTAL** 6.7 gal., 35 min.

This cycle is for lightly soiled china and crystal.

---

**PLASTICS CYCLE** **Heavy** 6.7 gal., 160 min.  
**Medium** 5.6 gal., 150 min.  
**Light** 4.5 gal., 130 min.

The longer time for this cycle includes a built-in drying portion that is specifically designed to reduce the risk of melting plastic items and improve plastic drying. For removing red tomato-based stains, GE recommends the use of Cascade® Plastic Booster™.

---

**SINGLE RACK WASH** **Heavy** 6.1 gal., 45 min.  
**Medium** 5.1 gal., 35 min.  
**Light** 4.1 gal., 30 min.

This cycle washes lightly soiled dishes on the upper rack only.

---

**RINSE ONLY** 2.3 gal., 10 min.

For rinsing partial loads that will be washed later. Do not use detergent with this cycle.

**NOTE:** On the PDW8900 Series models, the **CHINA CRYSTAL/PLASTICS** selector is a toggle pad; toggle the pad until the desired cycle is indicated.

**NOTE:** This dishwasher is equipped with a CleanSensor™ with automatic temperature control; therefore, cycle length and time may vary depending on soil and temperature conditions.

**NOTE:** Only the Anti-Bacteria cycle has been designed to meet the requirements of Section 6, NSF 184 for soil removal and sanitization efficacy.

## 4 Enhancements

The light above the selected pad will be **ON** to indicate which **ENHANCEMENT** has been selected.

---

**DELAY HOURS** You can delay the start of a wash cycle for up to 24 hours (depending on model). Press the **DELAY START** pad to choose the number of hours you want to delay the start of the cycle; then press **START/RESET**.

After closing the door, the machine will count down and automatically start at the correct time.

**NOTE:** To cancel the **DELAY START** selection before the cycle begins, press the **DELAY START** pad until the display shows the estimated cycle time for the selected cycle in minutes.

---

**ADDED HEAT (EXTRA HOT WASH)** When selected, the cycle will run longer with heating element on to improve both wash and dry performance.

**NOTE:** Cannot be selected with **RINSE ONLY** cycle.

---

**PRE WASH (on some models)** For use with heavily soiled and/or dried-on, baked-on soils. This option **MUST** be selected **PRIOR** to starting the cycle. This option adds 15 minutes to the cycle time.

**NOTE:** Cannot be selected with **RINSE ONLY** cycle.

---

**HEATED DRY Light Off** Shuts off the drying heat option. Dishes will air dry naturally (PDW8900 Series) or fan dry (PDW9700 and PDW9900 Series) to save energy.

---

**HEATED DRY** Turns the heating element on for fast drying. This will extend the total cycle time by 15 minutes for the **ANTI-BACTERIAL** cycle, 8 minutes for the **SPEED** cycle, 15 minutes for the **PLASTICS** cycle, 30 minutes for the **CHINA CRYSTAL** cycle, and 38 minutes for all other cycles.

**NOTE:** Cannot be selected with **RINSE ONLY** cycle.

---

**LOCK** You can lock the controls to prevent any selections from being made. Or you can lock the controls after you have started a cycle.



**Children cannot accidentally start dishwasher by touching pads with this option selected.**

To unlock the dishwasher controls, press and hold the **HEATED DRY** pad for 3 seconds. To lock the dishwasher, press and hold the **HEATED DRY** pad for 3 seconds. The light above the **LOCK** pad will turn off.

---

**RESET** To change a cycle after washing starts. . .

**PDW8900 Series:** Touch the **START/RESET** pad to cancel the cycle. The **START/RESET** light will flash while the water is pumped out if needed. This takes approximately 2 minutes.

**PDW9700 and PDW9900 Series:** Open the door slowly to prevent splash-out. Touch the **START/RESET** pad to cancel the cycle. If the **START/RESET** light is flashing, close the door until the water pumps out (this takes approximately 2 minutes) and the light stops flashing.

When the light stops flashing, the dishwasher can be reprogrammed and restarted.



## **5** *Start*

---

### **PDW8900 Series**

Close the dishwasher door and select the cycle and desired enhancements. Touch the **START/RESET** pad to begin the cycle. Water fill begins immediately, and approximately 60 seconds later the wash action begins.

When the dishwasher door is fully closed, the control panel lights will display the last settings you selected. If you don't want to change any of the settings, simply touch the **START/RESET** pad to begin the cycle.

If the door is closed, the indicator lights will turn off if the **START/RESET** pad is not selected within 5 minutes. To activate the display, open and close the door or press any pad.

---

### **PDW9700 and PDW9900 Series**

After selecting the cycle and desired enhancements, touch the **START/RESET** pad to ready the dishwasher to begin the cycle. Close the door to start the cycle or begin the **DELAY START** countdown. When the cycle starts, the water fill begins and approximately 60 seconds later the wash action begins.

The dishwasher will always display your last selection and enhancements. If you don't want to change the settings, simply touch the **START/RESET** pad to ready the dishwasher and close the door to begin the cycle.

Also, if a power failure occurs **NORMAL** and **HEATED DRY** will automatically be programmed. Make any new selections and touch the **START/RESET** pad to begin the new cycle.

If the door is opened, the indicator lights will turn off if the **START/RESET** pad is not selected within 5 minutes. To activate the display, open and close the door or touch any pad.

---

## **6** *Clean*

---

### **PDW8900 Series**

The **CLEAN** light is illuminated when the selected cycle and enhancements are complete. The light will stay **ON** until a pad is pressed or the door is opened and then closed.

---

### **PDW9700 and PDW9900 Series**

The **CLEAN** light is illuminated and a double beep will sound when the selected cycle and enhancements are complete. You may remove the dishes at any time. Note the high-efficiency fan will run quietly for 30 minutes to 4 hours (depending on selected cycle) after the **CLEAN** light is illuminated to continue drying the dishes. The fan can be turned off by opening the door and pressing any keypad.

**NOTE:** To turn off the audible end-of-cycle signal (or re-activate it if it was previously disengaged), press the **HEATED DRY** pad 5 times within 3 seconds. A triple beep will sound to indicate the end-of-cycle beep option has been toggled.

**NOTE:** If you are not using the SmartDispense and you want to turn the **LOW DETERGENT** LED light off, press the **ADDED HEAT** pad 5 times within 3 seconds. You will hear three beeps, then the light will go off. You can turn the light back on by pressing the **ADDED HEAT** pad 5 times within 3 seconds.

# Component Locator Views

PDW8900 Series Shown

Inside Cabinet View



Left Side View

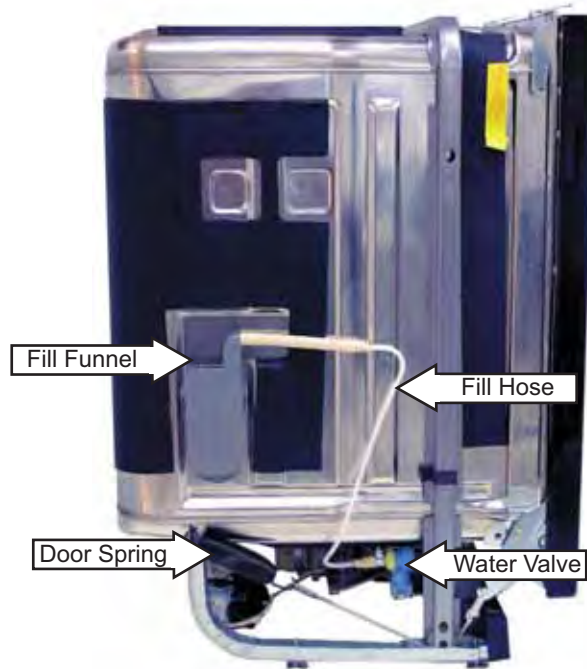

1 - Upper Spray Arm, 2 - Middle Spray Arm, 3 - Lower Spray Arm, 4 - Hub, 5 - Filter Screen, 6 - Heating Element, 7 - Float, 8 - Smart Dispense Cap

PDW8900 Series Shown

Door View

(Door Panel and Eschtcheon Keypad Assembly Removed)

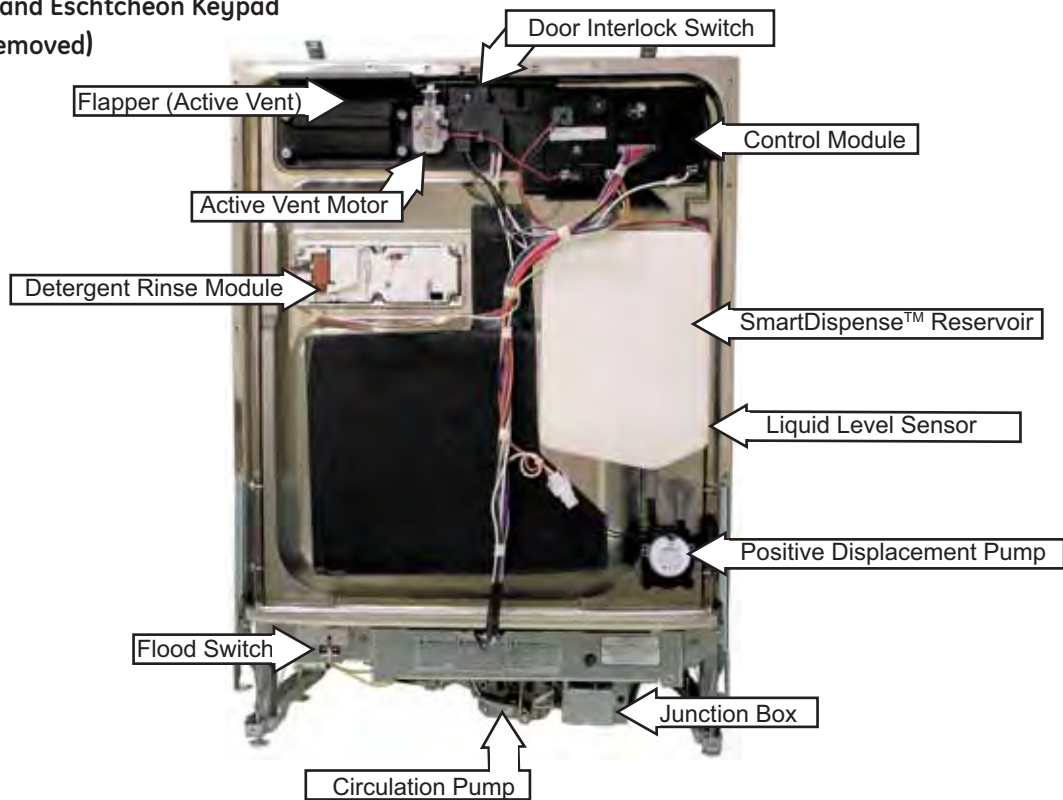

PDW9000 Series Shown

Door View (Door Panel Removed)

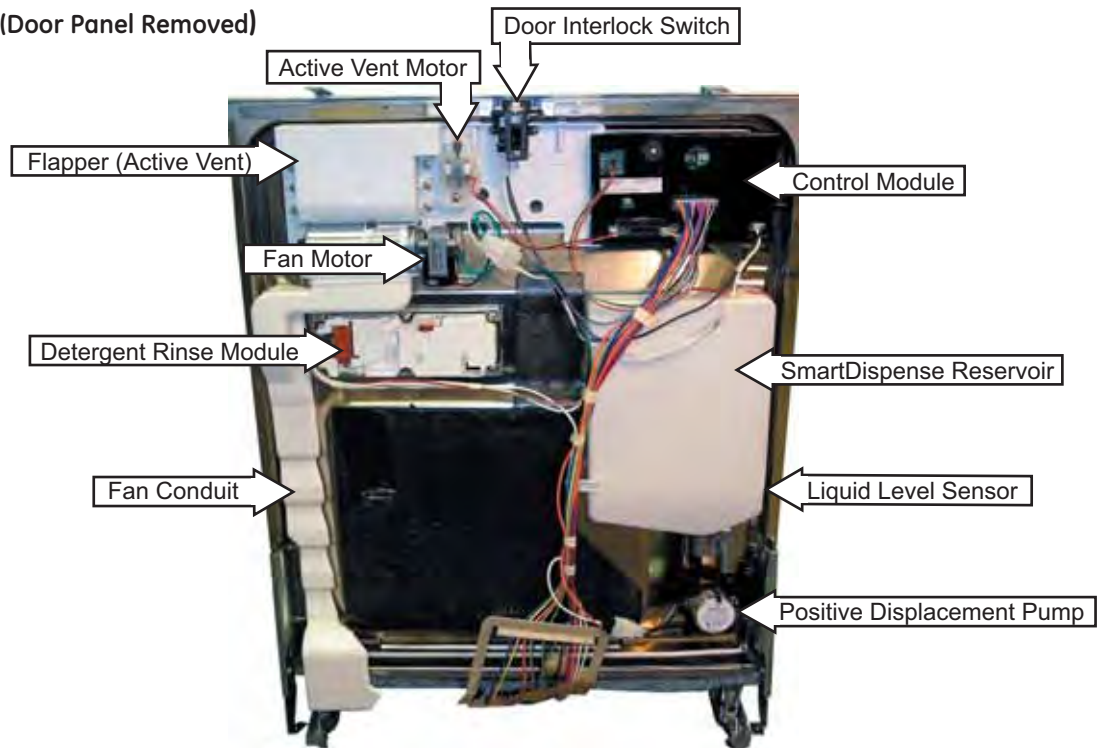

PDW8900 Series Shown

Bottom View

Front of Dishwasher

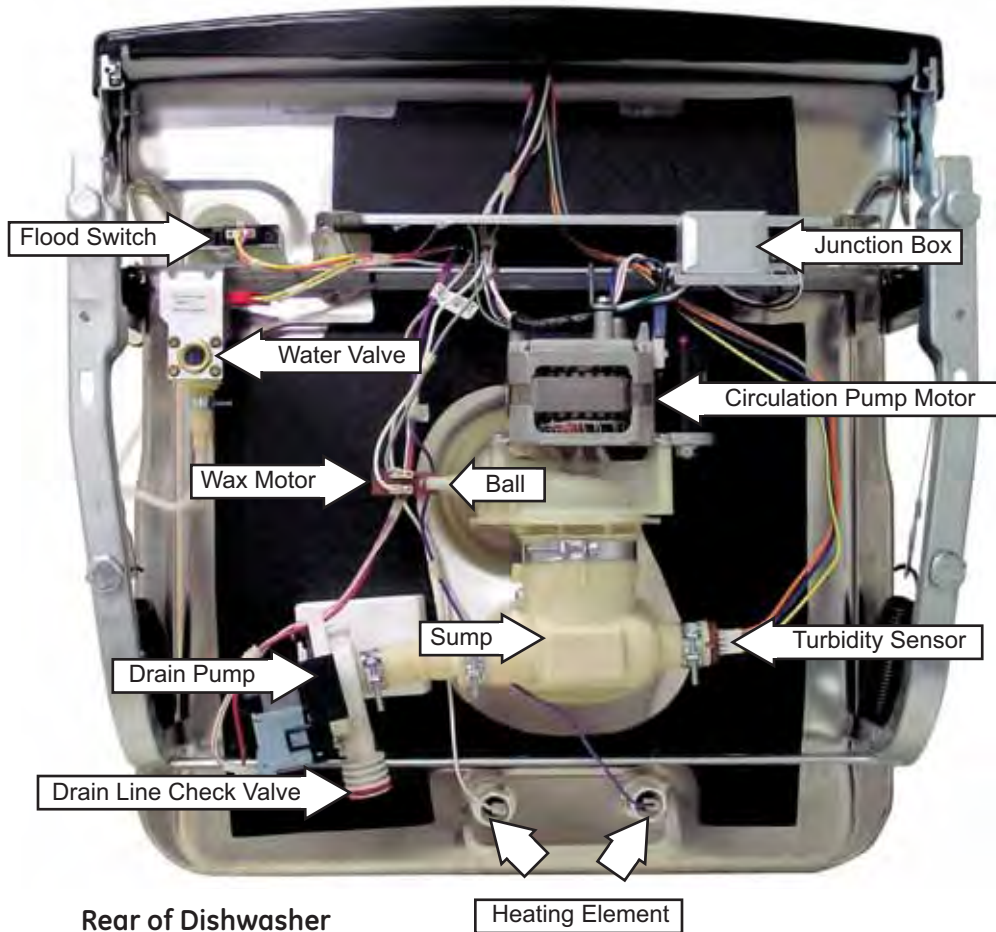

# Dishwasher Components

## Door Panel

### PDW9700 Series and PDW9900 Series

**Note:** For top control dishwashers, there must be  $\frac{1}{2}$ -inch clearance between the top of the door and the counter top.

The door panel covers the main control board, detergent cup, vent fan, motor, louver, wire harness, Smart Dispense bottle, Smart Dispense detergent sensor, Smart Dispense pump, and door-interlock switch.

The outer door panel is held in place by 12 screws (5 Phillips head screws per side and two  $\frac{1}{4}$ -in. hex head screws at the bottom).



**Note:** A ribbon cable connects the keypad membrane (3-digit display on some models) to the control circuit board. Due to the ribbon length, care must be taken when removing the door panel to ensure that the ribbon cable is not damaged.

### PDW8900 Series

The door panel covers the main control board, detergent cup, wire harness, Smart Dispense bottle, Smart Dispense detergent sensor, and Smart Dispense pump.

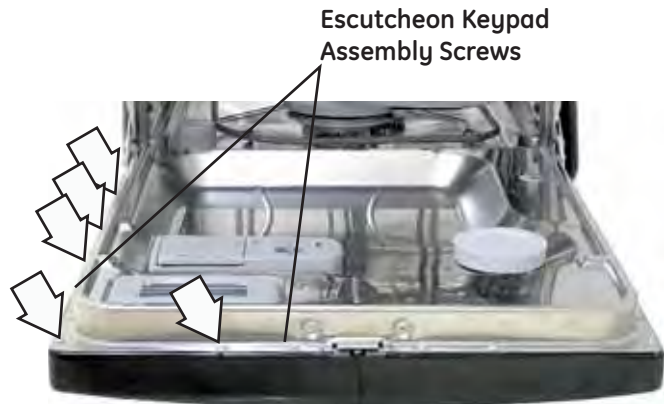

The outer door panel is held in place by 12 screws (5 Phillips head screws per side and two  $\frac{1}{4}$ -in. hex head screws at the bottom). The escutcheon keypad is held on by 4 screws.

**Note:** When removing the outer door panel, be careful not to remove the 4 screws (2 per side) holding the escutcheon to the door assembly. Remove these only to gain access to the control module, active vent, flapper, and door interlock switch.



## Keypad Assembly

### PDW9700 Series and PDW9900 Series

Top control models have a membrane keypad that is accessed by removing the door panel. (see *Door Panel*.)

- When removing the membrane keypad, peel the keypad from right to left.
- When installing, make sure the membrane button areas and lights align with the keypad.
- On models with an LED display, the display is held in place by 2 Phillips head screws.

**Note:** When replacing the keypad membrane, always run the **Factory Test Mode** to calibrate the keypad membrane to the control board.

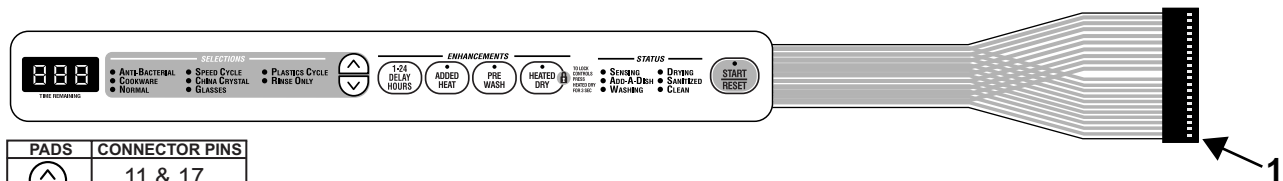

PADS	CONNECTOR PINS
	11 & 17
	11 & 16
	11 & 15
	12 & 15
	12 & 16
	12 & 17
	13 & 15

**Note:** When troubleshooting, always check resistance between pins 18 and 19. The membrane should read approximately 22K  $\Omega$ .

When a control pad is pressed, continuity is present on the corresponding pins. (See chart.) **Example:** If the HEATED DRY pad is pressed, you should have continuity between pins 12 and 17. To locate pin numbers, note location of pin 1 for reference point. (See illustration.)

### PDW8900 Series

The keypad and ribbon cable are a permanent part of the escutcheon and are replaced as a unit. To remove the escutcheon keypad assembly, remove the outer door panel and the 4 screws securing the escutcheon keypad assembly. (See *Door Panel, PDW8900 Series*.)

**IMPORTANT:** When assembling, the active vent flapper must be closed before the escutcheon keypad assembly is installed. Close the active vent flapper by turning the worm gear clockwise by hand. Failure to do so will cause a misalignment and an increase in noise level.

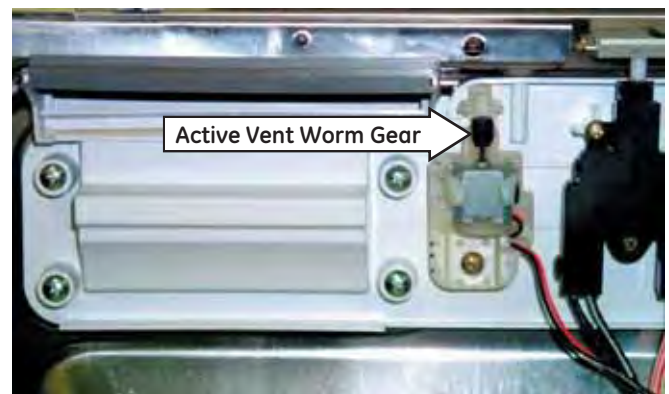

## Water Hardness Test and Calibration

### Test Water Hardness

The automatic liquid dishwashing detergent dispenser (SmartDispense™) dispenses the optimum amount of detergent to clean the dishes. This amount of detergent introduced during each cycle is based on the soil level of the dishes and the hardness of the water. Therefore, the correct water hardness setting is very important for both optimum cleaning of dishes and detergent usage.

Prior to the first use, this dishwasher must be calibrated for water hardness. This process requires the use of a water hardness test strip (part # WD01X10295). This part can be shipped by mail.

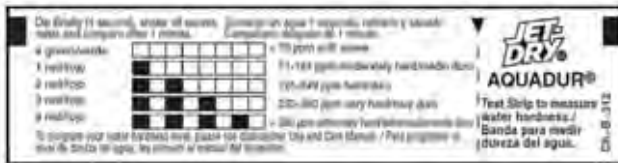

The 4 light green stripes will change color. The harder the water, the more stripes will change from green to red.

Water hardness should be tested following the instructions on the test strip package shown above.

**Note:** If all stripes remain green after the test, the outcome is "0 RED". The value to be entered into the dishwasher is "1".

Convert the test reading according to the table below.

### Water Hardness Test Strip Indication

Red Stripes on Strip	Value to Enter into Dishwasher
0	1
1	2
2	3
3	4
4	5

**Note:** 1 grain per gallon = 17.1 parts per million.

## SmartDispense™ Calibration

The calibration process will differ slightly depending on whether the dishwasher is front mount control (PDW8000 series) or top mount control (PDW9000 series).

### Front Mount Control (PDW8900)

Dishwasher must be in standby mode. Close and latch the door. Press normal wash to illuminate the lights on the control panel.

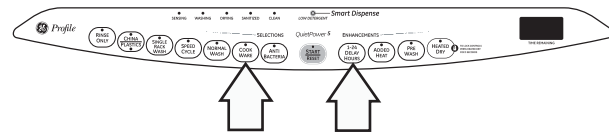

1. Press **Cookware** pad and **Delay Hours** pad together and hold for 3 seconds.
2. The current hardness setting will be shown on the **Time Remaining** display.
3. Enter the value from the test strip using the **Cookware** pad to increase the value or the **Normal Wash** pad to decrease the value.
4. Press the **Start/Reset** pad to return the dishwasher to normal operation. The last displayed value will be saved as the water hardness value.

### Top Mount Control (PDW9700, PDW9900)

Dishwasher must be in standby mode. Press up arrow to wake up control and illuminate the lights on the control panel.

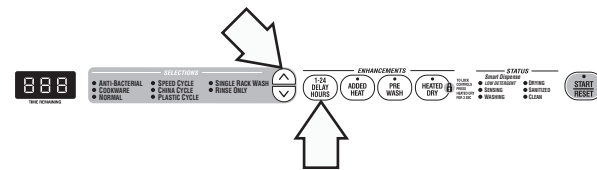

1. Press the up arrow pad and **Delay Hours** together and hold for 3 seconds.
2. The current hardness setting will be shown on the **Time Remaining** display.
3. Enter the value from the test strip using the up arrow pad to increase the value or the down arrow pad to decrease the value.
4. Press the **Start/Reset** pad to return the dishwasher to normal operation. The last displayed value will be saved as the water hardness value.

## SmartDispense™

SmartDispense™ is a bulk liquid detergent dispense assembly consisting of the following components:

- **Detergent Reservoir** - Mounted within the inner door panel
- **Detergent Level Sensor** - Connected to a Low Detergent LED on the control panel
- **Positive Displacement Pump** - Injects the optimal amount of detergent into the dishwasher during each cycle.

### Detergent Reservoir

**Note:** The SmartDispense™ system can only be used with liquid or gel automatic dishwasher detergent.

To fill the reservoir, push down on the cap covering the reservoir to engage the ratchet, then turn it counterclockwise to open.

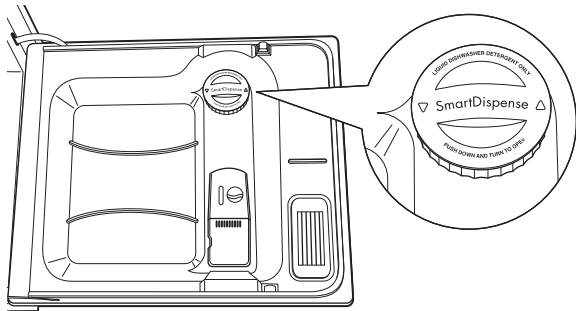

Position the door at a 30 to 45 degree angle. Fill the reservoir with a liquid automatic dishwasher detergent until the detergent reaches the threads of the reservoir access. The dispenser will hold approximately 45 ounces of liquid dishwasher detergent (about 1 to 2 months supply).

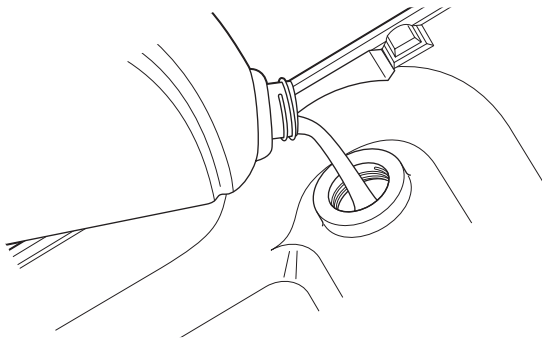

Place the cap on the reservoir access threads, push down, then turn clockwise until the cap is tight.

### To remove the reservoir:

**Note:** Removing the reservoir access collar causes structural damage to the collar. It must be replaced with a new part # WD35X10059.

Remove the door panel. (See **Door Panel**.) Insert a small flat-blade screwdriver into the slot in the side of the retaining collar and push the screwdriver handle counterclockwise while turning the reservoir access collar counterclockwise a quarter turn. Remove the retaining collar. Unplug the tube from the reservoir outlet and disconnect the sensor from the control module.



**Note:** The dispenser tank comes as an assembly. It includes the sensor with wire harness, gasket, and retaining collar. The complete assembly part number is WD35X10058.

## Detergent Level Sensor

The SmartDispense™ detergent level sensor consists of a single level detection continuity sensor and includes the following components:

- a grommet seal
- a low detergent LED indicator light
- a wire harness.

When the detergent in the reservoir drops below the continuity sensor, a signal is sent to the control board and the low detergent LED indicator light is turned on. The light indicates 3 to 7 wash cycles left before the detergent reservoir is completely empty.

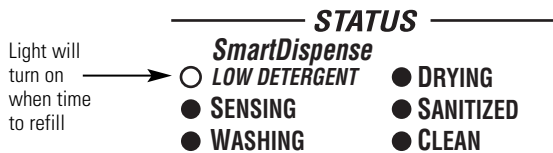

**Note:** The Low Detergent LED may look like it is illuminated when in fact it is not. An indicator that is illuminated will be a bright red.

**Note:** If the SmartDispense™ system is not being used, the low detergent light can be turned off (or on) by pressing the **Added Heat** pad 5 times within 3 seconds. There will be 3 audible beeps when the light goes off.

The sensor is similar to the type used in several automotive applications such as the windshield wiper fluid reservoir.



The control takes a reading of the detergent level at power up (when power is restored from an outage) and each time the door is closed and latched.

The control outputs a pulsing 5 VDC analog signal to the sensor and monitors the return voltage. Changes in the quantity of detergent in the tank change the amount of current drawn by the sensor.

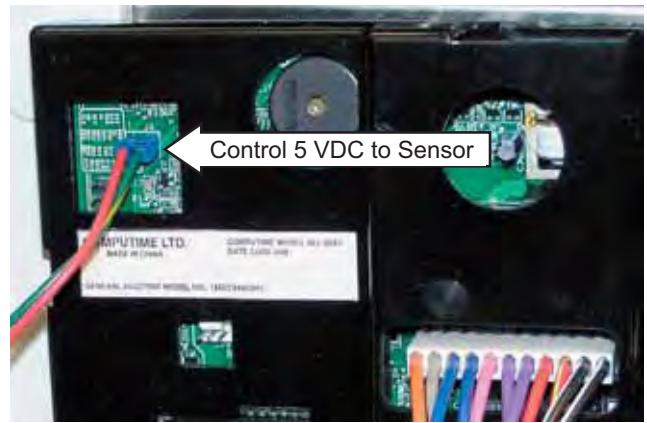

The routing of the DC wiring from the tank is very important. The 3 tape points on the tank keep the DC wiring perpendicular to the AC harness wiring running down across the front of the tank. (See tank photo.)

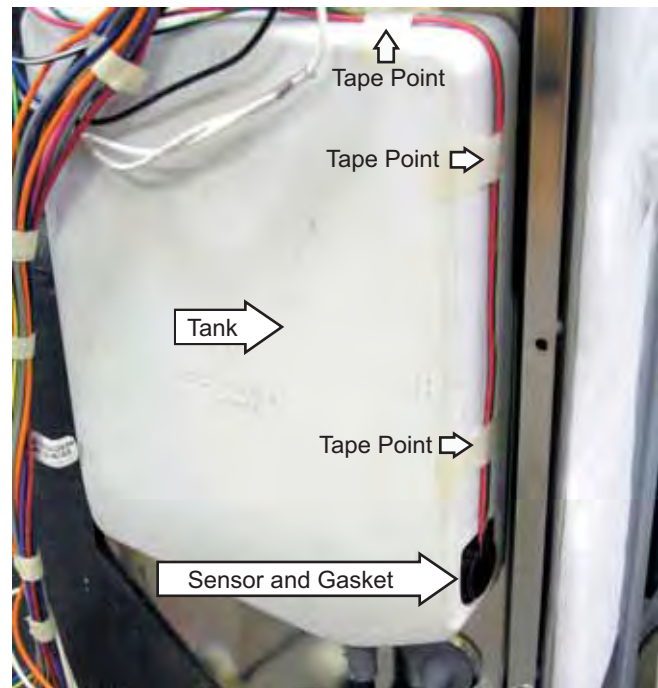

**Note:** The dispenser tank, sensor with wire harness, and gasket are only available as a complete assembly (part # WD35X10058). They are shipped with a new dispenser tank retaining collar.

### Detergent Level Sensor Strip Circuit





## Positive Displacement Pump

The SmartDispense™ positive displacement pump consists of a continuous flexible tube running from the detergent reservoir to the inner door detergent outlet. The tube runs around the inside edge of the pump housing. A 3-roller impeller fits tightly into the center of the pump housing with each of the 3 rollers squeezing the sidewall of the tube. As the impeller is driven counterclockwise by the motor, it squeezes out a predetermined amount of detergent for each 1/3 revolution of the impeller.

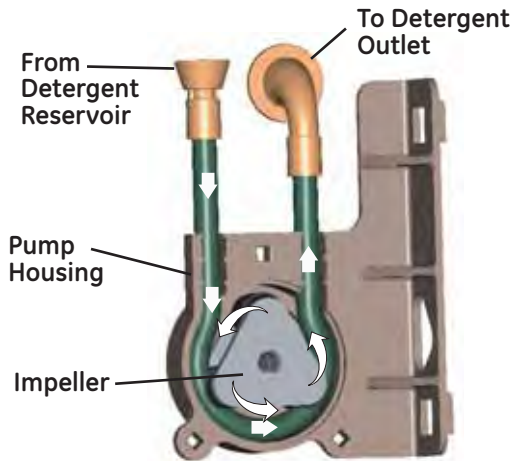

The dispenser pump operates on 120 VDC. During each pre-wash cycle, the pump is energized for 5 seconds, dispensing 4ml of detergent.

The electronic control uses two inputs to determine the total amount of detergent dispensed during the main wash cycle:

- Soil Level determined by the turbidity sensor
- Water Hardness as calibrated for the location

A water hardness selection mode permits the calibration of the water hardness for the location at installation. (See **Water Hardness Test and Calibration.**)

To determine the amount of detergent to dispense during the main wash, the control uses the following formula:

$$4\text{ml} \times \text{Number of Pre-washes} \\ + 25\text{ml} + \text{Additional Quantity for Hardness}$$

The additional quantity is a predefined quantity of detergent based on the water hardness level programmed into the control.

## Approximate Detergent Use

### Smart Dispense Dosage Amount

Dosage (ml)	Soil Level				
	1	2	3	4	
Hardness	1	33	41	49	57
	2	35.4	43.4	51.4	59.4
	3	37.8	45.8	53.8	61.8
	4	40.2	48.2	56.2	64.2
	5	42.6	50.6	58.6	66.6

### Smart Dispense Bottle Duration

Bottle Duration (wks)	Soil Level				
	1	2	3	4	
Hardness	1	10.3	8.3	6.9	5.9
	2	9.6	7.8	6.6	5.7
	3	9.0	7.4	6.3	5.5
	4	8.4	7.0	6.0	5.3
	5	8.0	6.7	5.8	5.1

## To remove the pump

1. Remove the door panel. (See **Door Panel.**)
2. Remove 2 Phillips head screws from the lower right side of the door edge to release the pump bracket.
3. Remove the grommet from the inner door panel and unplug the tube from the reservoir outlet.
4. Disconnect the wires and remove the pump.



## Positive Displacement Pump Strip Circuit

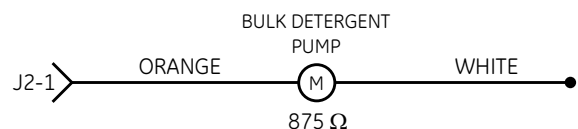

## Customer Purge of the Bulk Dispenser Tank

### When to Purge the Bulk Dispenser Tank

Only liquid or gel automatic dishwashing detergent can be used in the bulk dispenser. The dispenser must be purged if the consumer puts hand dishwashing detergent or a rinse agent in the dispenser. These products will produce copious amounts of suds, and water leaks will result every time the dishwasher is run until the tank is emptied.

The dishwasher must also be purged if a liquid dishwasher detergent containing chlorine (like Cascade Pure Rinse Formula) and a liquid dishwasher detergent containing enzymes (like Cascade Complete) have been mixed in the dispenser. When this happens, the chlorine destroys the enzymes resulting in poor wash performance. You can tell if the detergent contains chlorine or enzymes by reading the content label on the container.

A chemical reaction also takes place between the chlorine detergent and the enzyme detergent which causes the two liquids to coagulate and buildup around the detergent level sensor. This buildup may prohibit the sensor from sending the low detergent signal to the control board and the low detergent light will **not** be illuminated when the bulk dispenser is empty.

### Consumer Purge Cycle

The consumer must enter Service Mode to activate the purge cycle. The purge cycle fills the dishwasher for 57 seconds, then energizes the dispenser pump (instead of the main motor) continuously to drain the bulk dispenser tank.

The purge cycle deselects all other options and runs for 65 minutes. The consumer should run the purge cycle 3 times, filling the dispenser tank with water for the second and third cycles. **Total time is approximately 3 hours.**

Follow these steps carefully to have a successful purge run.

### Front Mount Controls (PDW8900)

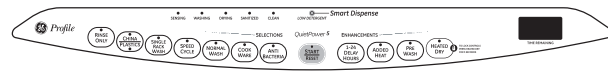

### Top Mount Controls (PDW9700, PDW9900)



1. Make sure **Pre-wash, Added Heat, and Heated Dry** LEDs are off.
2. Press **Heated Dry** pad and **Cookware** pad (down arrow pad on Top Mount Control models) together for 3 seconds. All LEDs illuminate.
3. Press **Added Heat** pad and **Normal** pad (up arrow pad on Top Mount Control models) together for 3 seconds. The **Anti-bacterial** LED illuminates.
4. Press **Start** pad one time.
5. Press **Normal Wash** pad and make sure **Pre-wash, Added Heat** and **Heated Dry** LEDs are off.
6. Press **Start** pad. Dishwasher will run a complete cycle without the main motor running. Cycle is complete when the clean light illuminates. This should take approximately 60 minutes.
7. Open door and wipe up the excess detergent from the door and tub.
8. Pour water on the door and tub where there is detergent residue.
9. Remove SmartDispense™ cap and fill tank with water. Replace cap.
10. Repeat steps 1 through 9 one time.
11. Repeat steps 1 through 6. When the **Clean** LED illuminates, the system is purged and ready to be refilled with the correct detergent.

## Detergent/Rinse Module

The door panel must be removed to access the detergent/rinse module. (See **Door Panel**.)

The detergent rinse module is held in place by 6 Phillips head screws and 2 brackets.

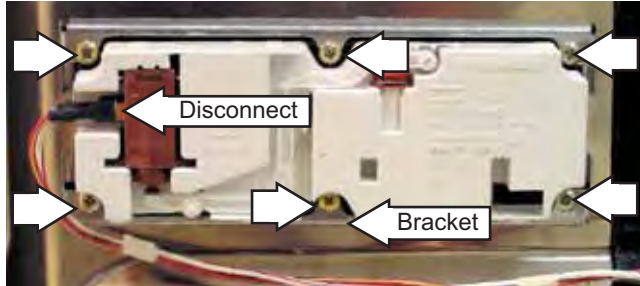

The detergent/rinse module automatically dispenses both the detergent and the rinse agent at the appropriate times. The module is activated 2 times during a wash cycle. Detergent is dispensed at the beginning of the main wash cycle and rinse agent at the beginning of the final rinse. The detergent/rinse module can be activated using the **Service Mode**.

### The first time the module is activated:

The lever slides up the right-hand path of the connecting rod (1). This action releases the detergent cover.

When deactivated (2), the lever returns down the left-hand path and comes to rest under the notch in the center of the connecting rod.



At the second activation (3), the lever lifts the connecting rod by the notch. This action lifts the rinse dispenser plunger and releases the rinse agent. When deactivated, the lever returns to its original starting position.



### Door Interlock Switch Strip Circuit

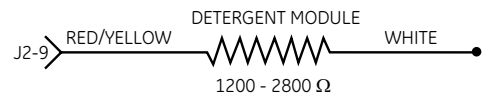

## Door Interlock Switch

The door interlock switch opens the L1 circuit when the door is open. The switch is replaced as an assembly.

The door panel and escutcheon must be removed to access the door latch switch. (See **Door Panel**.)

The door latch switch is held in place by 2 Phillips head screws.

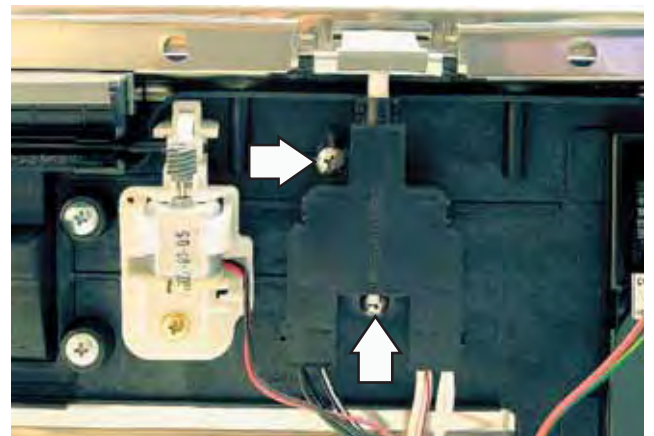

If the door is unlatched while running a wash cycle, the cycle countdown will pause and the vent will open. If unlatched for more than 15 seconds during a wash cycle, the control will beep once every 15 seconds until the door is relatched.

### Door Interlock Switch Strip Circuit

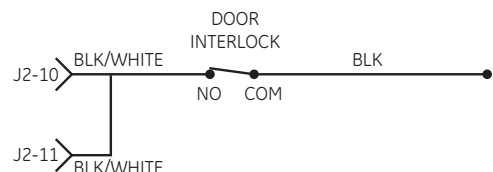

## Using the Dishwasher with the Upper Rack Removed

1. Unsnap and remove the end cap on each side of the rails.
2. Pull the rack straight out and off the rails.
3. Replace the end caps.
4. Push the rails all the way back into the dishwasher.

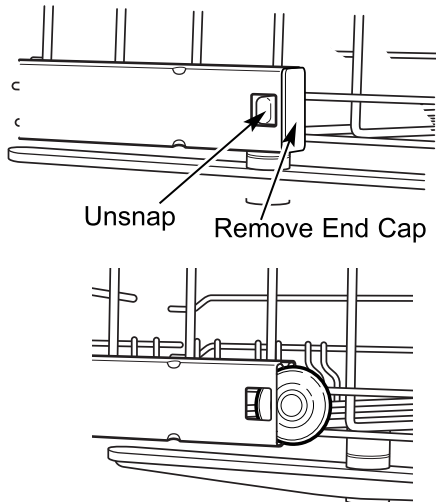

5. Slide the shower nozzle attachment over the spout.
6. The dishwasher is now ready for use.

**Note:** Always use the shower nozzle when the upper rack is removed.

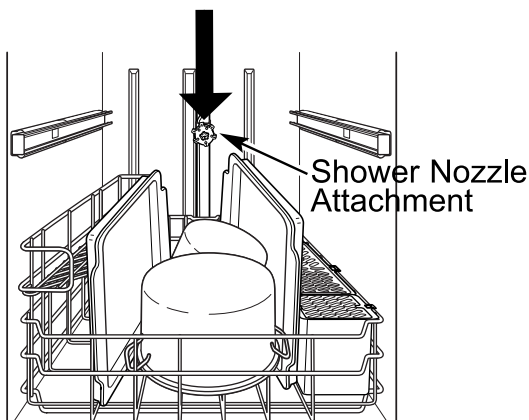

## Middle Spray Arm

1. Check holes in spray arm for bits of china, seeds, and other foreign matter.
2. Check spray arms for rotation.

### Removal and Replacement

1. Pull upper rack all the way out.
2. Remove plastic screw on bottom of middle spray arm. This will allow the middle spray arm and bearing to be removed.

**Note:** Install middle spray arm with spray jets facing the upper rack. Place bearing between spray arm screw and bottom of the middle arm.

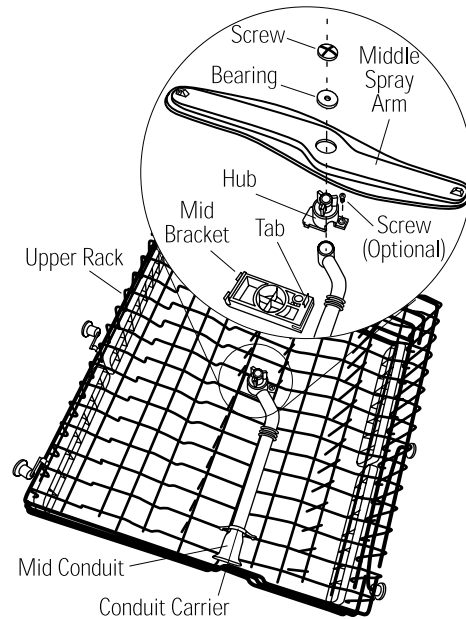

**Note:** If the upper rack experiences poor cleaning problems, ensure the middle spray arm is turning freely. If not, disassemble the middle spray arm and clean the bearing surface, then reassemble.

## Lower Spray Arm, Fine Filter, and Inlet Cover

Check the holes in spray arm for bits of china, seeds, and other foreign matter. Also check the spray wash arms for rotation. If soil is present, clean fine filter screen.

The lower spray wash arm can be removed by gently lifting and rotating it counterclockwise.

The nut hub can be removed by rotating it counterclockwise.

**Caution:** Use care to avoid breaking the clip on the hub when removing the main conduit from hub.

**Note:** When installing the fine filter, make sure the drain port of the filter is engaged with the drain for the fine filter.

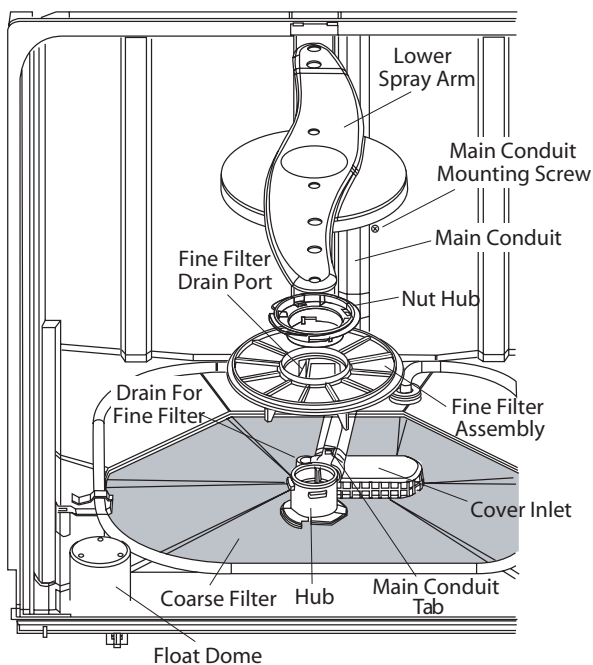

## Upper Spray Arm

Check the holes in spray wash arm for bits of china, seeds, and other foreign matter. Also, check the spray wash arms for rotation.

To remove the upper spray wash arm, remove the upper rack (see **Middle Spray Arm**), then remove the screw and upper spray wash arm.

## Main Conduit

The main conduit supplies water to the middle and upper spray wash arms.

### Removal and Replacement

1. Pull upper rack all the way out.
2. Push the tab on the outer slide cap in and remove the slide cap.
3. Remove the upper rack.
4. Release the bottom conduit tab.
5. Release 2 center conduit tabs and remove the main conduit.

## Fill Funnel

The top section of the fill funnel separates from the main body. The fill funnel body is held in place by a nut (located on the inside of the dishwasher). Rotate the nut counterclockwise to remove the main body. There is a gasket seal between the fill funnel and dishwasher tub. Make certain the gasket is seated when reinstalling.





## Heating Element

The heating element can be activated using **Service Mode**.

The dual-wattage heating element produces 875 watts during wash, to help heat the water, and an effective wattage due to cycling of 700 watts during the dry cycle.

It is normal for the heating element to cycle during Heated Dry cycle. The control energizes the heating element continuously for the first 6 minutes. The control then cycles the heating element on for 60 seconds, and off for 60 seconds for the remainder of the Heated Dry cycle.

Selecting Added Heat will energize the heater for the entire time during the last prewash cycle and the final rinse cycle. Circulation time during the final rinse is increased 2.8 times the normal with this option. If selected after the wash cycle has started, the feature will not take effect until the beginning of the next fill. This option is not available for the Rinse Only cycle.

Water inlet temperature must be at least 120°F for proper drying. Low water inlet temperature will prevent proper convection air movement and increase drying time substantially.

If the problem is that the dishes are not drying correctly, don't overlook the rinse agent. A rinse agent will improve the water sheeting action and drying performance.

It is normal for the stainless steel tub and the inner door panel to retain water droplets even though the dishes are dry.

### Heating Element Strip Circuit

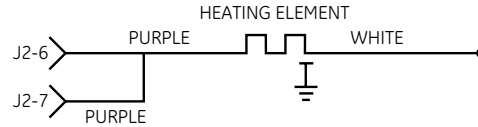

The heating element nuts are located on the underside of the washer, near the back. Ample force is required to remove the nuts. Removing the dishwasher from installation may be required.

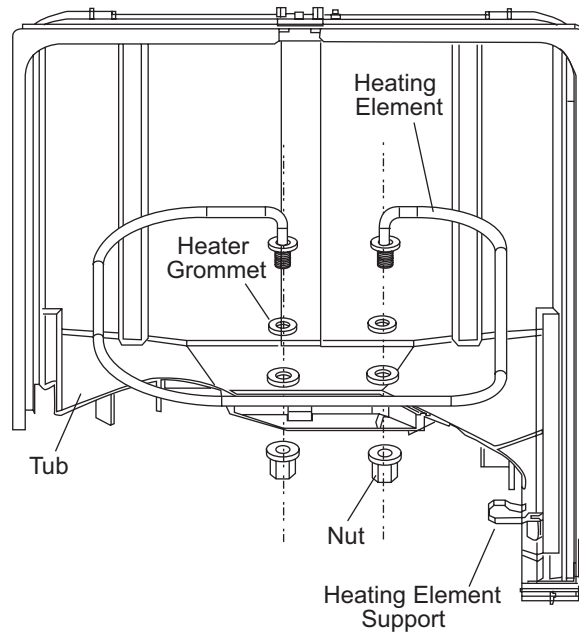

## Turbidity Sensor

The turbidity sensor is located on the side of the sump.

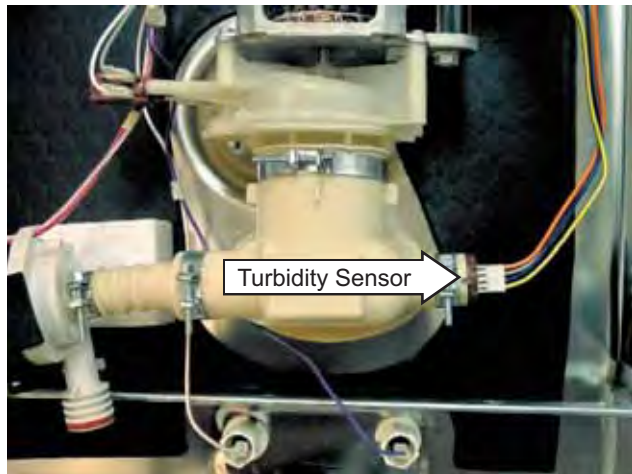

The turbidity sensor measures the amount of suspended particles in the wash water in the sump. The control sends the turbidity sensor a pulse width modulated 5-volt signal for calibration and usage during operation.

The control then receives an analog signal of the sensed turbidity, which is processed by the microprocessor.

The baseline reading is taken during the first fill when the sump water level is between the  $\frac{1}{4}$ - to  $\frac{3}{8}$ -in. gap between the LED transmitter and the receptor. Successive turbidity measurements are supplied to the control module and used to determine whether any prewash or rinse cycles can be skipped. The sensing LED is on during all prewash cycles and during the final rinse.

Decisions are based on a comparison of clean water measurements at the beginning of the first fill, measurements taken at selected fills, and water temperature. By measuring the turbidity level, the control module can conserve energy on lightly soiled loads by skipping unnecessary cycles.

**Note:** If the turbidity sensor circuit fails to open or is shorted, the sensing LED on the control panel will **not** light, and the unit will operate for the maximum amount of time, using the maximum number of wash and rinse fills for the selected cycle.

The turbidity sensor also contains the thermistor for automatic temperature control.

### Turbidity Sensor Test

The thermistor's resistance has a negative temperature coefficient. As the temperature increases, the resistance goes down. At 75°F, the resistance is approximately 9.9K  $\Omega$ . At 140°F, the resistance is approximately 2.8K  $\Omega$ .

**Note:** When installing the turbidity sensor, align the key on the sensor with the keyway on the sump.

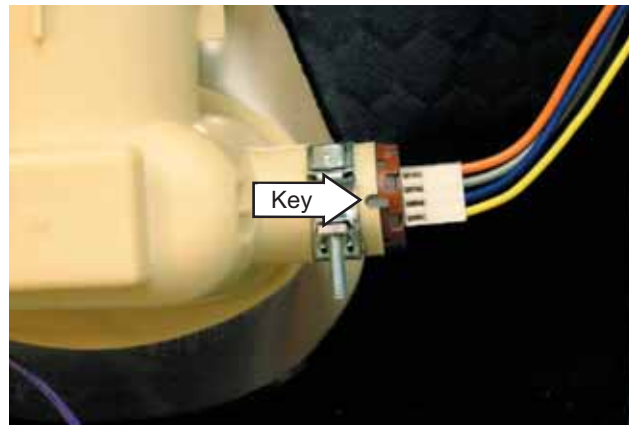

The Service Mode is the most accurate way to test the turbidity sensor circuit. The turbidity sensor circuit contains the control module, wiring, and the turbidity sensor.

### Turbidity Sensor Strip Circuit

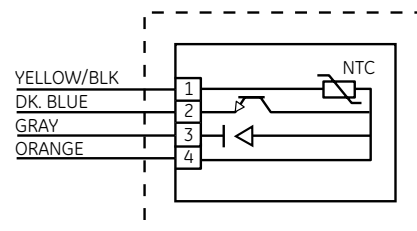

### Calibrating the Turbidity Sensor

When replacing the turbidity sensor, or if it has been disconnected, always calibrate the turbidity sensor to the control board.

**Note:** The calibration cycle **MUST** be entered within 2 minutes of power up.

Press the Normal pad (the up arrow pad on Top Control Models) and the Cookware pad (the down arrow pad on Top Control Models) for 3 seconds or until all LEDs turn on.

The dishwasher will then perform a series of steps. Once the drain cycle starts, calibration is complete and the Start/Reset pad can be pressed to end the calibration cycle. The dishwasher will continue to pump out remaining water and cycle of.

## Drain System

The drain system consists of the following components:

- Auxiliary drain pump (includes motor and one-way check valve)
- Drain tube
- Check valve (in line with drain tube)
- Drain hose

The inlet cover prevents large particles from entering the sump. Water entering the drain pump is not filtered by the fine filter (metal) or by the sump filter (plastic). The drain pump is mounted on the sump and contains a one-way check valve. The drain pump is controlled by the control module and can be activated using Service Mode.

### Auxiliary Drain Pump strip Circuit

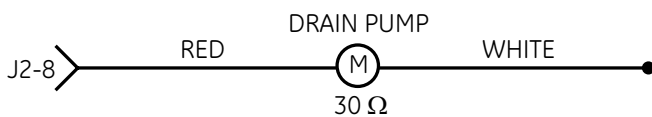

The drain pump utilizes a 120V AC motor. The motor should read approximately  $30 \Omega$ .

**IMPORTANT:** The drain system of this dishwasher requires either a high drain loop or an air gap. Installations without either a high drain loop or an air gap will not perform properly.

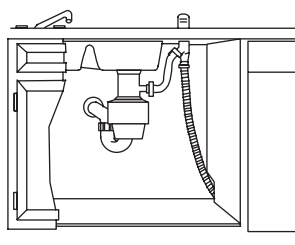

Air Gap

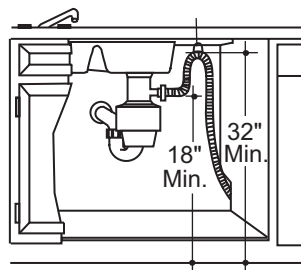

High Drain Loop

## Smart Fill System

The Smart Fill system consists of a new silent fill hose design and electronically controlled cavitation sensing (adaptive fill).

The new fill hose design uses a rigid plastic tube with rubber over mold at both ends. This smaller diameter reduces water flow rate and fill noise. The required water line pressure is still 20 to 120 psi.

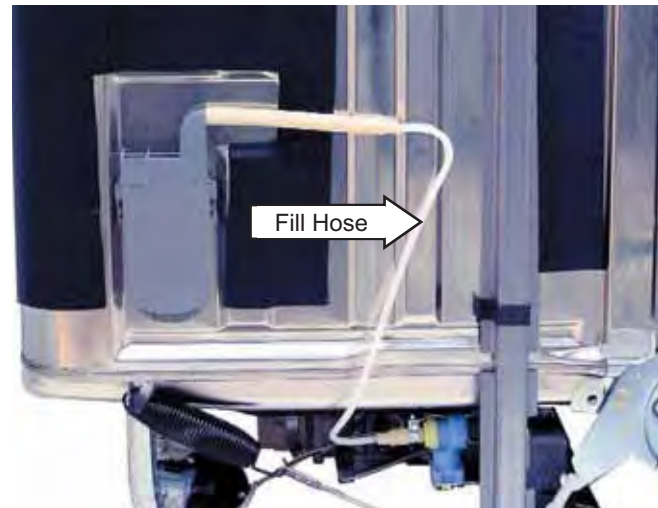

The cavitation sensing controls the amount of water for each fill. The dishwasher fills for 57 seconds, then the pump motor starts. The load on the motor changes as water enters and exits the sump. The electronic control monitors this change as motor current fluctuation and continues to fill the tub until the fluctuations are stable, assuring the sump is full.

**Note:** The maximum amount of time the electronic control will energize the water valve is 95 seconds.

During a normal wash cycle, the water level in the tub will cover the sump screen or be just to the rear edge of the heater bracket. The dishwasher will fill with approximately 1.2 gal. of water.



Depending on the wash cycle selection, a complete wash cycle will use between approximately 2.5 gal. (Rinse Only) to 10.9 gal. (Cookware - heavy soil level).



## Water Valve and Flood Switch

The water valve is a 120 VAC solenoid valve that is switched on/off by the control module. The flood switch acts as a safety switch ONLY and does not control normal operation of the water valve. The flood switch opens the L1 side of the water valve circuit.

The switch is normally open. The weight of the flood switch float holds the switch closed. The flood switch will not stop the flow of water if the valve sticks open from a mechanical failure.

The water valve can be replaced with the dishwasher installed.

**WARNING:** Disconnect power to dishwasher before servicing water valve and flood switch.

The flood switch is held in place by 2 Phillips head screws.

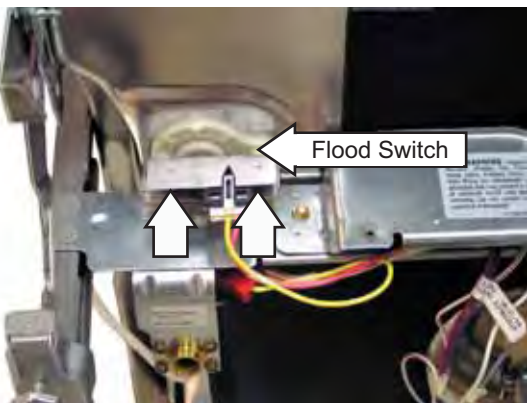

The water valve is secured to the frame by 2 hex head screws.

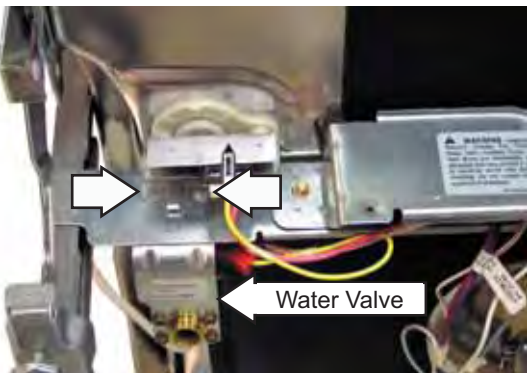

**Note:** To prevent leaks after installation, ensure that hose-to-valve connection is good and that clamp is in place.

## Water Valve Test

**Note:** The detergent pump will also operate during the water valve test.

1. Attempt to activate water valve using Service Mode. Pump out water as necessary using Service Mode. If an intermittent failure is suspected, activate water valve 5 times using Service Mode. Water valve should stay on for 75 to 95 seconds per activation and should not turn on and off during the 75 to 95 second activation time. A normal fill will be approximately 1.2 gallons.
2. If the water valve is not operating properly or water level is low, check the following:
  - Water valve, flood switch, flood switch float and stem, transorb, and then main control. The flood switch should open when the water level is approximately  $\frac{1}{4}$ -in. above the base (bottom) of the float dome.
  - Resistance through the water valve solenoid coil is  $725 \Omega$  to  $1200 \Omega$ .
  - Clogged screen in water valve.

### Water Valve Strip Circuit

PDW9700 Series and PDW9900 Series

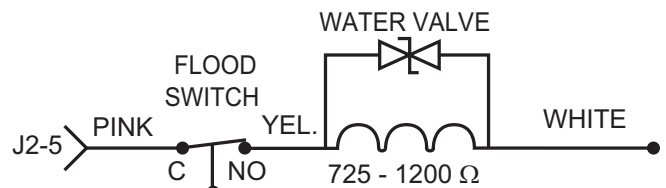

PDW8900 Series

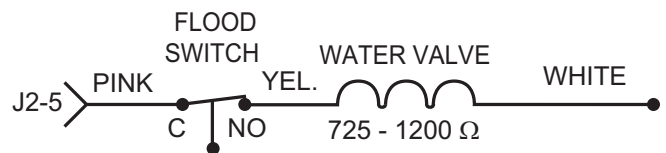

## Demo Mode

- Demo mode is entered by pressing the **Cookware** pad (down arrow pad on Top Control models) and **Added Heat** pad simultaneously for 5 seconds.
- When entered, the **Normal** and **Added Heat** LEDs blink for 3 seconds, and the active vent will close.
- Pressing a pad will light the corresponding LED.
- Pressing the Start/Reset pad will activate the main pump for 20 seconds, and each cycle LED will be lit in sequence for 3 seconds (left to right).
- The display will sequence 999, 888, 777, 666, 555, etc., before running the main pump.
- The cycle will end after the main pump stops. The drain cycle will not be energized.
- To exit the demo mode, the dishwasher must be disconnected from power.

## Wash Cycles

CYCLE	MAX # OF PRE-WASH CYCLES	WASH CYCLE	MAX # RINSE CYCLES	WASH TIME <sup>1</sup>		WASH TEMPERATURE		HEATED DRY TIME	FAN ON TIME <sup>6</sup>	
				MIN	MAX	MIN	MAX		HEATED DRY	W/O HEATED DRY
Normal Wash	3	1	3	36	99	137 <sup>2</sup>	145 <sup>2</sup>	38+5	158	240
Speed Wash	3	1	2	23	53	130 <sup>3</sup>	150 <sup>3</sup>	8	128	240
China Crystal	2	1	3	26	61	130 <sup>3</sup>	135 <sup>3</sup>	30	150	240
Pots & Pans	4	1	3	60	112	150 <sup>2</sup>	140 <sup>2</sup>	38	158	240
Sani Wash	3	1	3	36	115	130 <sup>3</sup>	158 <sup>3</sup>	15+15 <sup>4</sup>	150	240
Plastics	3	1	2	76	136	140 <sup>2</sup>	145 <sup>2</sup>	45/60 <sup>5</sup>	180	240
Glasses	2	1	3	26	61	130 <sup>3</sup>	140 <sup>3</sup>	30	150	240
Single Rack Wash	3	1	3	36	96	137 <sup>2</sup>	145 <sup>2</sup>	38	158	240
Rinse Only	2	0	0	9	11	–	–	–	–	240

Time is in minutes

Temperature is in degrees Fahrenheit

- 1.) Cycle times do not include water fill and drain
- 2.) Heater on in main wash and final rinse
- 3.) Heater on in all pre-washes, main wash, and all rinses
- 4.) Heated dry time and cool down time
- 5.) 45 minutes without heated dry, 60 minutes with heated dry
- 6.) Fan running time after cycle has completed

## Control Module

The door panel must be removed to access the control module. (See **Door Panel**.) The main control is considered a “smart” control, capable of learning the water temperature and turbidity characteristics of the home.

It is normal for the cycle times to vary over a period of time from the factory default settings due to temperature and water quality.

The control module is held in place by a single screw that secures the module to the right side of the inner door panel. (The screw is located on the outside of the inner door panel.)

The module cover is held in place by 5 tabs (see arrows).

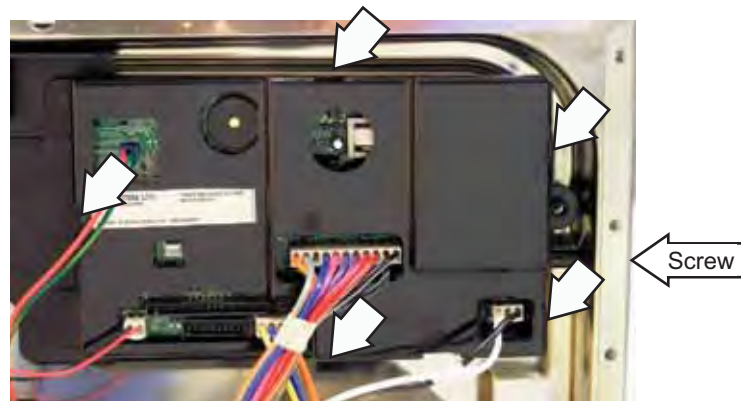

## Control Module Board

**Note:** When replacing the control module, always run the Factory Test Mode to calibrate the keypad membrane and turbidity sensor to the control board.

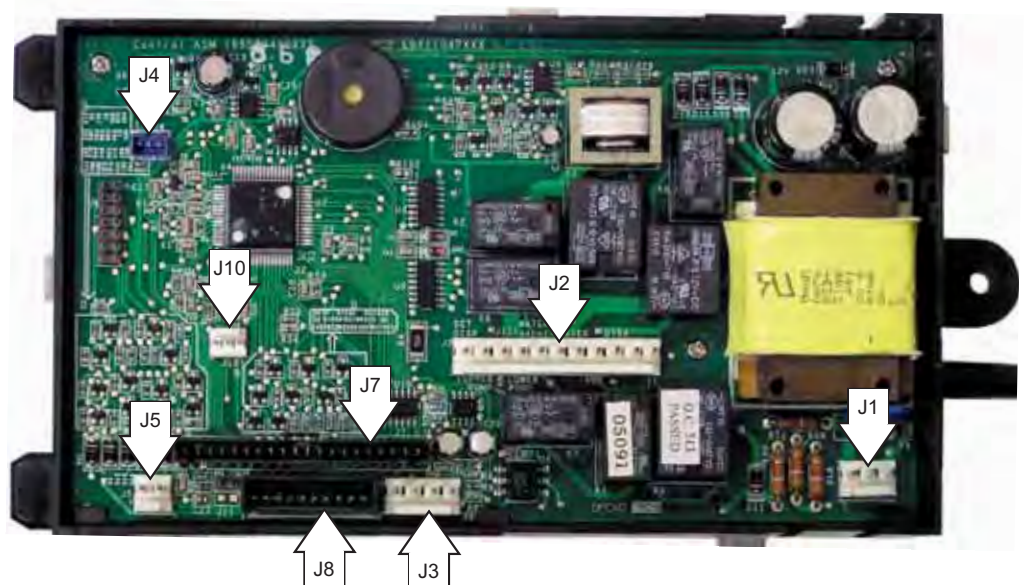

J1 - Power Supply X

J2 - Heating Element, Circulation Pump, Drain Pump, Fan, Water Valve, Detergent Module, Wax Motor, Bulk Detergent Pump

J3 - Turbidity/Temperature Sensor

J4 - Detergent Sensor

J5 - Active Vent

J7 - Keypad

J8 - 3-Digit Display

J10 - PQA

## Active Vent

The active vent consists of the fan, motor, housing, and vent louver motor.

The active vent helps to reduce the noise level and heat loss when in the closed position. The control module supplies +/- 12 VDC to the vent louver motor. The control module reverses polarity to drive the motor in a clockwise or counterclockwise (open or closed) direction.

The vent closes 8 seconds after the main pump is switched on during the first fill cycle and opens during the drying cycle (heated and non-heated). The vent is open during cooldown periods or when the unit is not in use.

If the vent is closed and the door is opened during the wash cycle, the vent will open. When the door is closed again, the vent will remain open for 8 seconds, then close again to finish the cycle.

It is normal for water vapor to come through the active vent during the dry cycle. The active vent can be opened and closed using the **Service Mode**.

The vent louver is held in place by a single screw.

Remove the motor from the mount by rotating the motor 90° in the mount and sliding it out between the tabs.

**Note:** The gear in the mount is held in place with the motor.



Vent Motor Strip Circuit

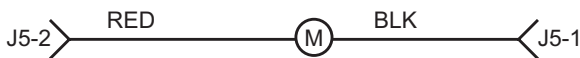

## Fan (PDW9700 AND PDW9900 Series)

During natural dry, the fan runs for approximately 4 hours after the last drain cycle is completed (clean light on). During heated dry, the fan runs for approximately 2 hours after the last drain cycle is completed. If the door is opened, the fan stops and the control stops counting down. When the door is relatched, the fan will start again and the control will continue to count down. Touching any key will turn off the fan.

**Note:** This also applies to the **Rinse Only** cycle. Since heated dry is not an option with **Rinse Only**, the fan will run for approximately 4 hours before turning off.

To access the vent fan and motor, remove the door panel (see **Door Panel**).

The vent fan and motor housing are held in place by:

- 4 long, silver Phillips head screws.
- 2 short, brass Phillips head screws (see photo).

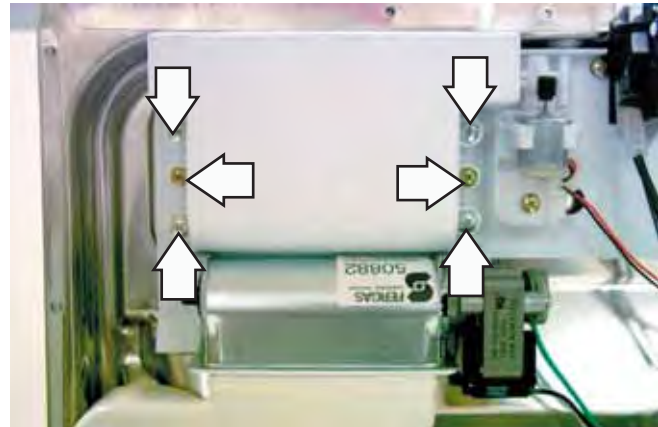

**Note:** Foam with double-sided tape holds the conduit in place. The foam tears easily if pulled during removal of the housing.

Six Phillips head screws hold the fan and motor to the vent housing.



Fan Motor Strip Circuit

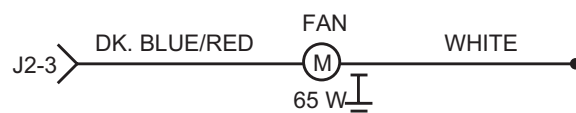

## Single Rack Wash™

The Single Rack Wash™ bypasses the lower spray arm, directing the water flow only to the upper rack. A plastic-covered steel ball, released by a wax motor-controlled magnet, is forced by the water flow to block the venturi for the lower spray arm. Cleaning power is directed to the top basket ONLY through the middle and upper spray arms. In Single Rack Wash™, the tub fills with approximately 0.1 to 0.2 gals. less than a normal wash cycle.

**Normal Wash Cycle:** The pump fills with water to the level indicated. The magnet on the end of the wax motor holds the ball out of the water flow path. The impeller spins counterclockwise to a high velocity. Water flowing from the impeller outward, fills all chambers.

**Single Rack Wash™ Cycle:** The pump fills with water to the level indicated. At the same time, the wax motor energizes and pulls the magnet away. This releases the ball from its position at the bottom of the guide rail.

The impeller spins counterclockwise to a high velocity. The water flows from the impeller and carries the ball up the guide rail. The ball wedges into the low-arm channel restricting the flow from the lower spray arm. The water flow is now diverted to only the upper and middle spray arms.

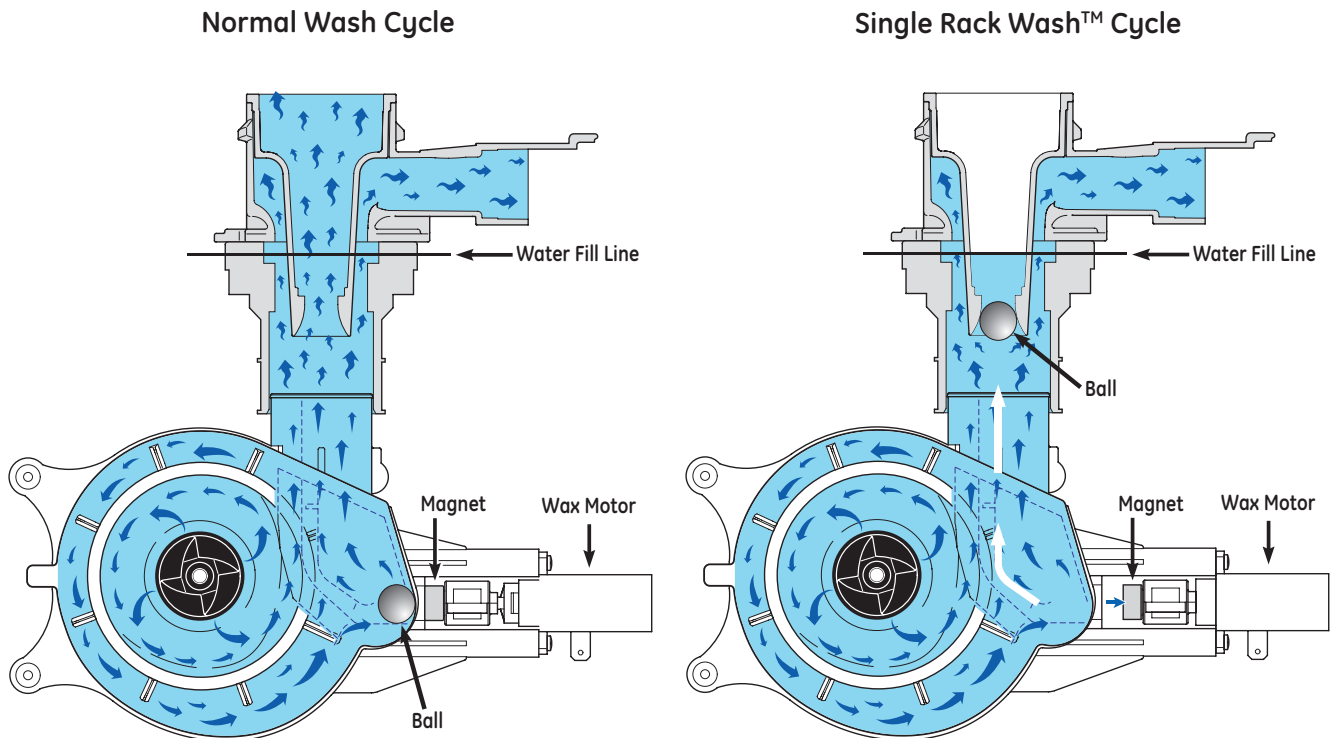



## Circulation Pump and Motor

The dishwasher has a new pump design that includes a wax motor, magnet, and a steel ball used for Single Rack Wash™. This pump must be replaced with the same pump design (kit # WD26X10029).

The pump housing contains a molded channel to direct the movement of the ball towards the venturi. The plastic shell which encases the stainless steel ball has ribs to prevent the ball from sticking in the venturi.

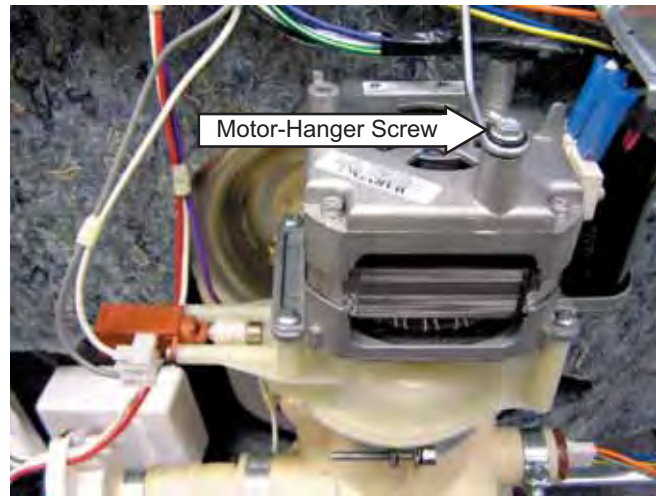

### Circulation Pump and Motor Strip Circuit

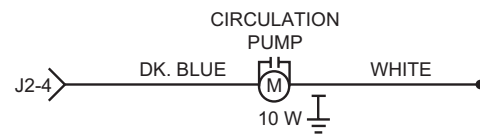

The dishwasher must be removed from its installation to gain access to the circulation pump and motor. The circulation pump can be activated using Service Mode. Refer to schematic or strip circuit for motor resistance value.

Before removing the circulation pump, remove the water from the sump with a syringe.

It is important to remember that the motor does not start immediately when the dishwasher cycle has started (60 seconds after water begins to fill). If the motor hums but will not start, make certain the pump impeller is free from obstruction and the motor shaft turns freely.

The terminals on the induction motor are labeled L1 and N. The motor is thermally protected (internally) through the L1 side. The wiring connector is blue to match the wire leading to the motor. It is designed to fit only one way on the terminals. Make certain the connector is fully seated when installing.

The replacement motor pump assembly contains a new ball.

**Caution:** Be sure the ball is in place and held by the magnet before reassembling the unit.

**Note:** It is important that the hex-head motor-hanger screw is tightened securely when reinstalling the circulation pump.

## Wax Motor and Magnet

The wax motor and magnet (part # WD21X10235) are an assembly and are held to the pump housing by 2 Phillips screws. The wax motor operates on 120 VAC. It takes approximately 45 seconds for the magnet to retract far enough to release the steel ball when the wax motor is at room temperature. The wax motor is energized for approximately 1 minute.

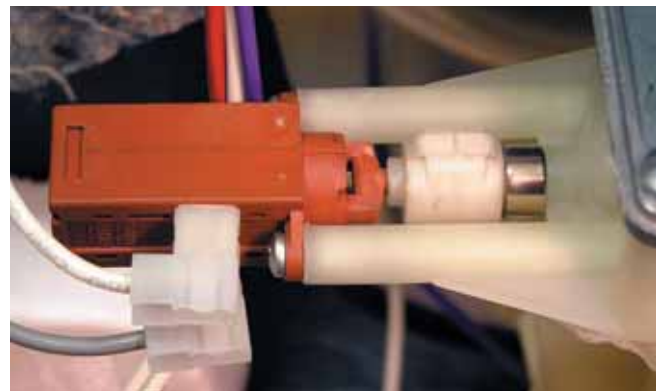

If the dishwasher door is opened during the Single Rack Wash™, the ball will once again be held by the magnet until the wax motor retracts the magnet from the steel ball (approximately 45 seconds).

### Wax Motor Strip Circuit

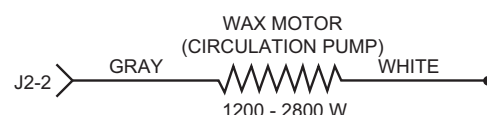

## Door Spring Installation

The PDW8900 Series all have black door springs. They are hooked in the END hole of the door cable.



The PDW9900 Series has 1 black door spring hooked in the MIDDLE hole of the door cable and 1 black door spring with white painted markings hooked in the END hole.



The PDW9700 Series all have black door springs. They are hooked in the MIDDLE hole of the door cable. Black springs with white painted markings are packaged with the dishwasher for use with heavy door panels.



# Service Mode

This dishwasher is programmed with a service mode to aid the technician in troubleshooting the dishwasher. Each component may be cycled to detect if it is functioning correctly. Components are cycled by pressing keypads to the right or the left of the **Start/Reset** keypad.

## PDW8900 Series

To enter service mode, press and hold the **Cookware** and **Heated Dry** keypads simultaneously for 3 seconds. To exit service mode, press the **Start/Reset** keypad at any time.

### 12-BUTTON FLAT/BOWED PANEL\*

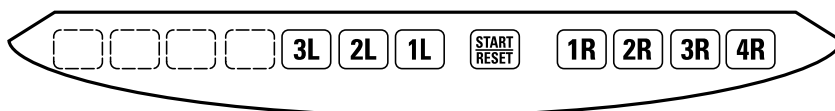

\*BOWED PANEL SHOWN

PAD	Description	Time
1L	Not Used	
2L	Activates/Deactivates Auxiliary Pump	Variable
3L	Activates/Deactivates Main Pump and Single Rack Wash Motor (Wax Motor)	Variable
1R	Activates/Deactivates Detergent Cup	Variable
2R	Activates/Deactivates Water Valve and Smart Detergent Dispenser	Variable
3R	Not Used	
4R	Activates/Deactivates Heater	6 min.

## PDW9700 Series and PDW9900 Series

To enter service mode, press and hold the "Down" arrow and **Heated Dry** keypads simultaneously for 3 seconds. To exit service mode press the **Start/Reset** at any time.

### 7-BUTTON TOP CONTROL PANEL



PAD	Description	Time
1L	Activates/Deactivates Heater and Fan	Test times out after 6 minutes.
2L	Not Used	
3L	Activates/Deactivates Water Valve and Smart Detergent Dispenser	Variable
4L	Activates/Deactivates Detergent Cup	Variable
5L	Activates/Deactivates Auxiliary Pump	Variable
6L	Activates/Deactivates Main Pump and Single Rack Wash Motor (Wax Motor)	Variable

**\*Note:** Service mode may be used for 30 minutes maximum. After 30 minutes, the service mode will automatically turn off.



# Factory Test Mode

**Always run the factory test mode to calibrate when replacing the turbidity sensor, control module board, and membrane key panel.**

The factory test mode is the most accurate way to test the turbidity sensor circuit, which contains the control module, wiring, and turbidity sensor. Factory test mode will test the thermistor (used for automatic temperature control) that is contained in the turbidity sensor and will test the transmitter that is contained in the turbidity sensor.

## Entering Factory Test Mode

**Note:** This mode can only be entered within the first 2 minutes after power-up. After 2 minutes, factory test mode is unavailable.

Disconnect power from dishwasher. Wait 10 seconds and connect power to dishwasher. Press the **Normal** and **Cookware** ("**Up**" and "**Down**" on Top Control Models) keypads simultaneously for 3 seconds. (This step must be performed within 2 minutes of power-up.) The control will step through the test cycle for the preset amount of time. Press **Delay/Hours** to advance to the next step.

## TEST CYCLE

1. All LEDs illuminate for 10 seconds.
2. Vent fan energizes for 5 seconds, then the active vent closes.
3. Detergent module is activated. Water valve energizes for 60 seconds.
4. Main pump is energized. Water valve continues filling for an additional 10 seconds.
5. Heater is energized and main pump continues to run for an additional 60 seconds.
6. Dishwasher pauses for 40 seconds. During this time the turbidity sensor, control module board, and membrane keypad are being calibrated.
  - a. The control module will beep continuously and the lock icon LED will light if:
    - 1) The temperature sensor check does not fall between the limits (42°F to 199°F).
    - 2) The control receives an analog signal outside the expected range for the turbidity sensor.
    - 3) The EEPROM was not read correctly.
7. Drain pump energizes for 75 seconds.
8. The detergent module is energized for 60 seconds and the water valve is energized for 70 seconds.
9. The heater and main pump are energized for 60 minutes. (Press DELAY/START DELAY/HOURS on some models to advance to the next step before control times out.)
10. Active vent opens, drain pump is energized for 75 seconds, then active vent closes.

**Note:** If the calibration test fails, check the following:

- Make certain the dishwasher is not located on a non-insulated outer wall where the temperature at the turbidity sensor may be below 42°F.
- The turbidity sensor may be dirty. Run a rinse only cycle with one cup vinegar or use citric acid crystals (WD35X151) to clean the sensor.

# Schematics and Strip Circuits

## PDW8900 Series

**WARNING:** Disconnect electrical power before servicing.

**Caution:** Label all wires prior to disconnection. Wiring errors can cause improper and dangerous operation. Verify operation after servicing.

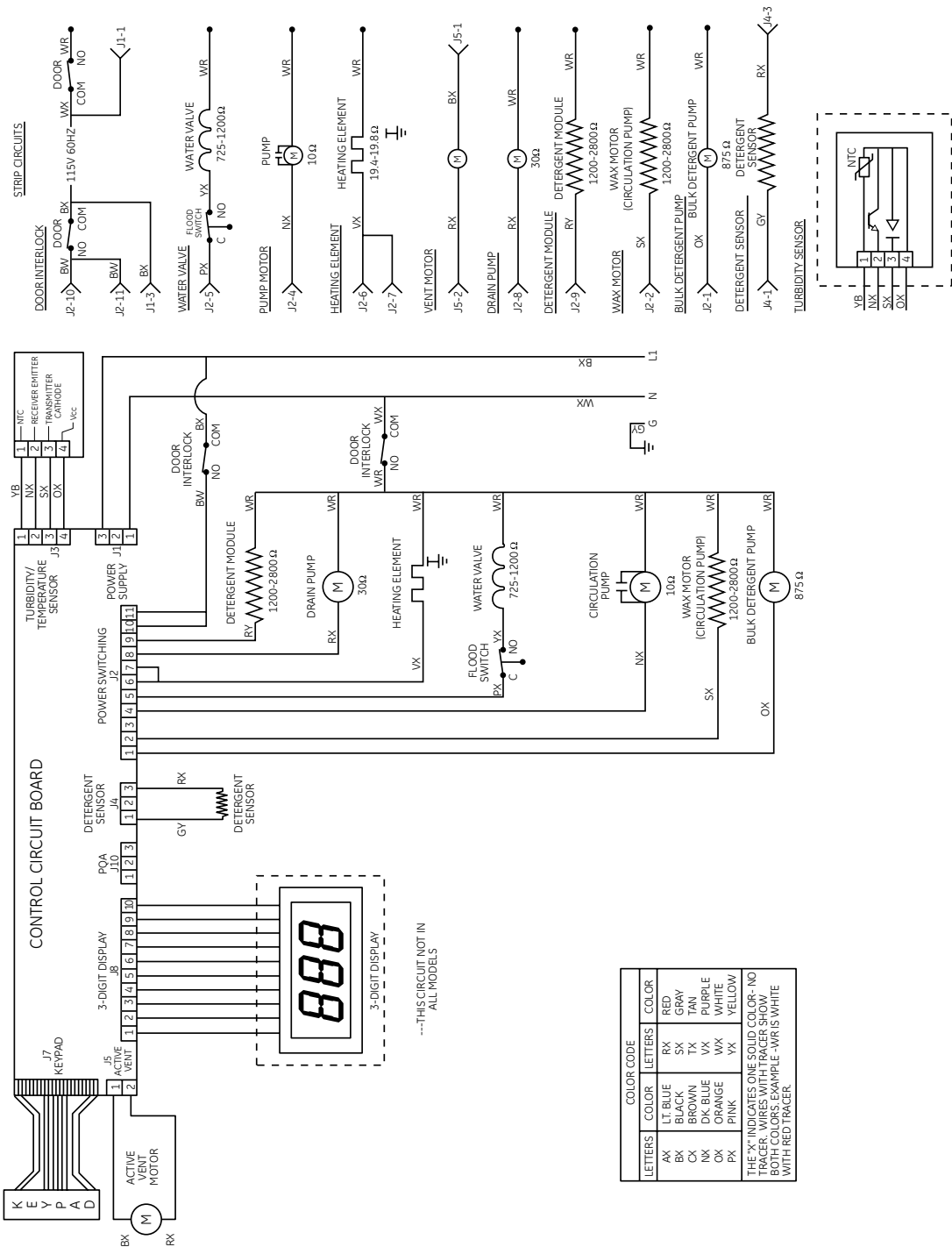

LETTERS	COLOR	LETTERS	COLOR
AX	LT BLUE	RX	RED
BX	BLACK	SX	GRAY
CX	BROWN	VX	PINK
DX	OR-BLUE	WX	PURPLE
EX	OR-ANGE	YX	WHITE
PX	PINK	VX	YELLOW

THE "X" INDICATES ONE SOLID COLOR. NO TRACER. WIRES WITH TRACER SHOW BOTH COLORS. SAMPLE-WR IS WHITE WITH RED TRACER.

# PDW9700 Series and PDW9900 Series

**WARNING:** Disconnect electrical power before servicing.

**Caution:** Label all wires prior to disconnection. Wiring errors can cause improper and dangerous operation. Verify operation after servicing.

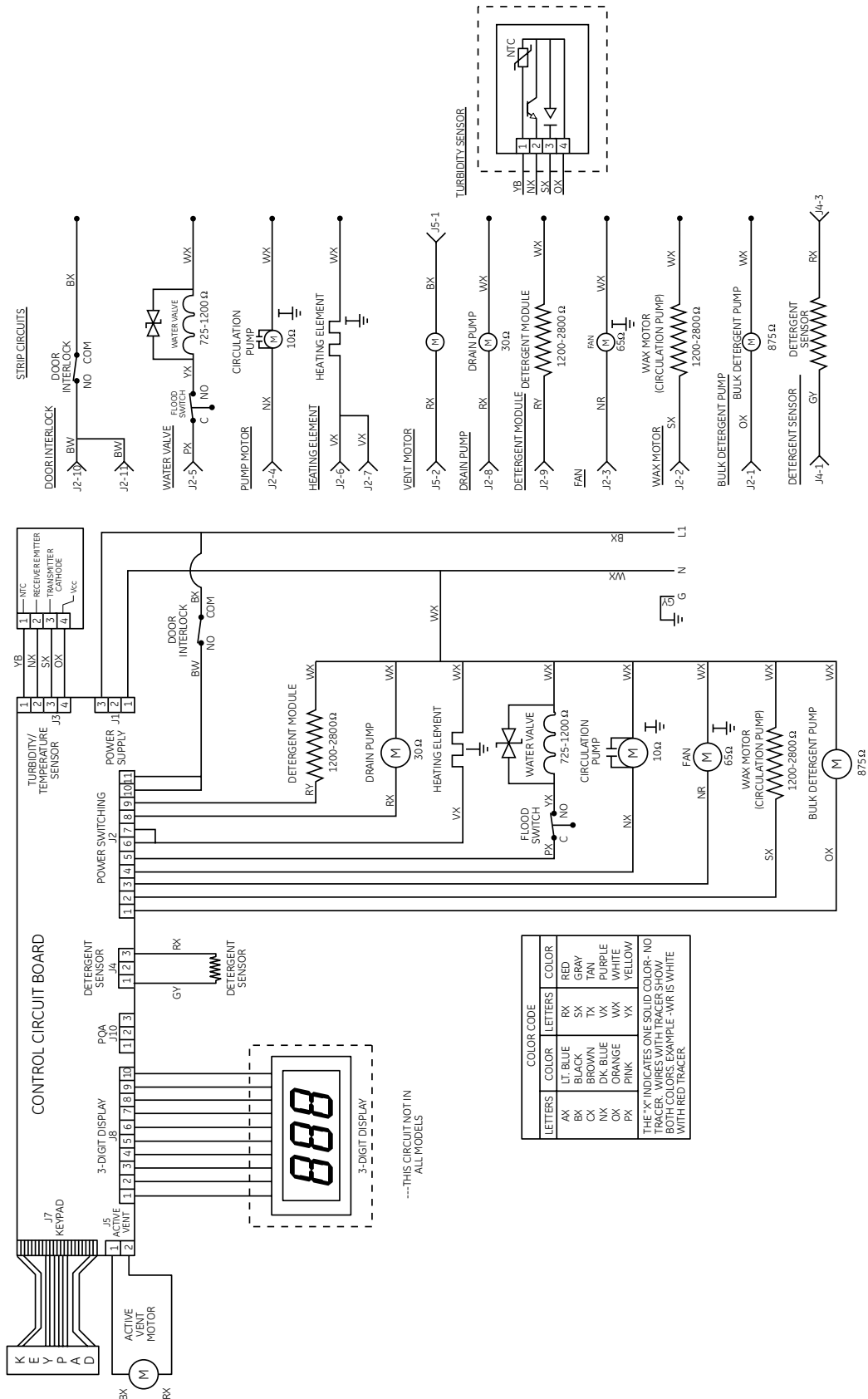

### STRIP CIRCUITS

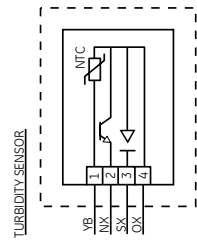
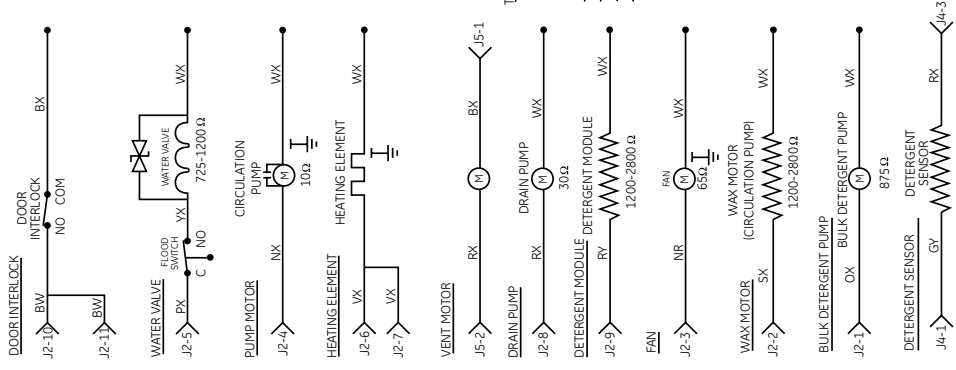

COLOR CODE		
LETTERS	COLOR	COLOR
AX	LT. BLUE	RK
BK	BLACK	SK
CX	BROWN	TX
NX	DK. BLUE	VX
OX	ORANGE	WX
PX	PINK	YX

THE "X" INDICATES ONE SOLID COLOR- NO TRACER. WIRES WITH TRACER SHOW BOTH COLORS. EXAMPLE -WR IS WHITE WITH RED TRACER.

---THIS CIRCUIT NOT IN ALL MODELS

# Warranty for 2005 Product

## **For The Period Of: GE Will Replace:**

<b>One Year</b> From the date of the original purchase	<b>Any part</b> of the dishwasher which fails due to a defect in materials or workmanship. During this <b>full one-year warranty</b> , GE will also provide, <b>free of charge</b> , all labor and in-home service to replace the defective part.
<b>Second Year</b> From the date of the original purchase	<b>Any part</b> of the dishwasher which fails due to a defect in materials or workmanship. During this <b>second-year limited warranty</b> , you will be responsible for any labor or in-home service costs.
<b>Five Years</b> From the date of the original purchase	<b>The dishwasher racks and the electronic control module</b> if they should fail due to a defect in materials or workmanship. During this <b>five-year limited warranty</b> , you will be responsible for any labor or in-home service costs.
<b>Lifetime of Product</b>	<b>The Stainless tub or door liner</b> , if it fails to contain water due to a defect in materials or workmanship. During this <b>full warranty</b> , GE will also provide, <b>free of charge</b> , all labor and in-home service to replace the defective part.

## **What GE Will Not Cover (for customers in the United States):**

- Service trips to your home to teach you how to use the product.
- Improper installation, delivery or maintenance.
- Failure of the product if it is abused, misused, or used for other than the intended purpose or used commercially.
- Replacement of house fuses or resetting of circuit breakers.
- Damage to the product caused by accident, fire, floods or acts of God.
- Incidental or consequential damage caused by possible defects with this appliance.
- Cleaning or servicing of the air gap device in the drain line.
- Damage caused after delivery including damage from items dropped on the door.

*This warranty is extended to the original purchaser and any succeeding owner for products purchased for home use within the USA. Proof of original purchase date is needed to obtain service under the warranty. In Alaska, the warranty excludes the cost of shipping or service calls to your home.*

*Some states do not allow the exclusion or limitation of incidental or consequential damages. This warranty gives you specific legal rights, and you may also have other rights which vary from state to state. To know what your legal rights are, consult your local or state consumer affairs office or your state's Attorney General.*

**Warrantor: General Electric Company, Louisville, KY 40225**

## **What Is Not Covered (for customers in Canada):**

- Service trips to your home to teach you how to use the product.
- Improper installation.  
If you have an installation problem, contact your dealer or installer. You are responsible for providing adequate electrical, exhausting and other connecting facilities.
- Failure of the product if it is abused, misused, or used for other than the intended purpose or used commercially.
- Replacement of house fuses or resetting of circuit breakers.
- Damage to the product caused by accident, fire, floods or acts of God.
- Damage caused after delivery including damage from items dropped on the door.

WARRANTOR IS NOT RESPONSIBLE FOR CONSEQUENTIAL DAMAGES.

Warrantor: CAMCO INC.

# Warranty for 2006 and Later Product

## For The Period Of: GE Will Replace:

<b>One Year</b> From the date of the original purchase	<b>Any part</b> of the dishwasher which fails due to a defect in materials or workmanship. During this <b>limited one-year warranty</b> , GE will also provide, <b>free of charge</b> , all labor and in-home service to replace the defective part.
<b>Five Years</b> From the date of the original purchase	<b>The dishwasher racks and the electronic control module</b> if they should fail due to a defect in materials or workmanship. During this <b>five-year limited warranty</b> , you will be responsible for any labor or in-home service costs.
<b>Lifetime of Product</b>	<b>The Stainless tub or door liner</b> , if it fails to contain water due to a defect in materials or workmanship. During this <b>limited warranty</b> , GE will also provide, <b>free of charge</b> , all labor and in-home service to replace the defective part.

## What GE Will Not Cover (for customers in the United States):

- Service trips to your home to teach you how to use the product.
- Improper installation, delivery or maintenance.
- Failure of the product if it is abused, misused, or used for other than the intended purpose or used commercially.
- Replacement of house fuses or resetting of circuit breakers.
- Product not accessible to provide required service.
- Damage to the product caused by accident, fire, floods or acts of God.
- Incidental or consequential damage caused by possible defects with this appliance.
- Cleaning or servicing of the air gap device in the drain line.
- Damage caused after delivery, including damage from items dropped on the door.

**EXCLUSION OF IMPLIED WARRANTIES—Your sole and exclusive remedy is product repair as provided in this Limited Warranty. Any implied warranties, including the implied warranties of merchantability or fitness for a particular purpose, are limited to one year or the shortest period allowed by law.**

This warranty is extended to the original purchaser and any succeeding owner for products purchased for home use within the USA. If the product is located in an area where service by a GE Authorized Servicer is not available, you may be responsible for a trip charge or you may be required to bring the product to an Authorized GE Service location for service. Proof of original purchase date is needed to obtain service under the warranty. In Alaska, the warranty excludes the cost of shipping or service calls to your home.

Some states do not allow the exclusion or limitation of incidental or consequential damages. This warranty gives you specific legal rights, and you may also have other rights which vary from state to state. To know what your legal rights are, consult your local or state consumer affairs office or your state's Attorney General.

**Warrantor: General Electric Company, Louisville, KY 40225**

## What Is Not Covered (for customers in Canada):

- Service trips to your home to teach you how to use the product.
- Improper installation.  
If you have an installation problem, contact your dealer or installer. You are responsible for providing adequate electrical, exhausting and other connecting facilities.
- Failure of the product if it is abused, misused, or used for other than the intended purpose or used commercially.
- Replacement of house fuses or resetting of circuit breakers.
- Damage to the product caused by accident, fire, floods or acts of God.
- Damage caused after delivery.

**EXCLUSION OF IMPLIED WARRANTIES—Your sole and exclusive remedy is product repair as provided in this Limited Warranty. Any implied warranties, including the implied warranties of merchantability or fitness for a particular purpose, are limited to one year or the shortest period allowed by law.**

This warranty is extended to the original purchaser and any succeeding owner for products purchased for home use within Canada. In home warranty service will be provided in areas where it is available and deemed reasonable by Camco to provide.

WARRANTOR IS NOT RESPONSIBLE FOR CONSEQUENTIAL DAMAGES.

Warrantor: CAMCO INC.