

GE Consumer & Industrial

Technical Service Guide

June 2006

GE Built-In Dishwasher

GLDA690
GLDA696

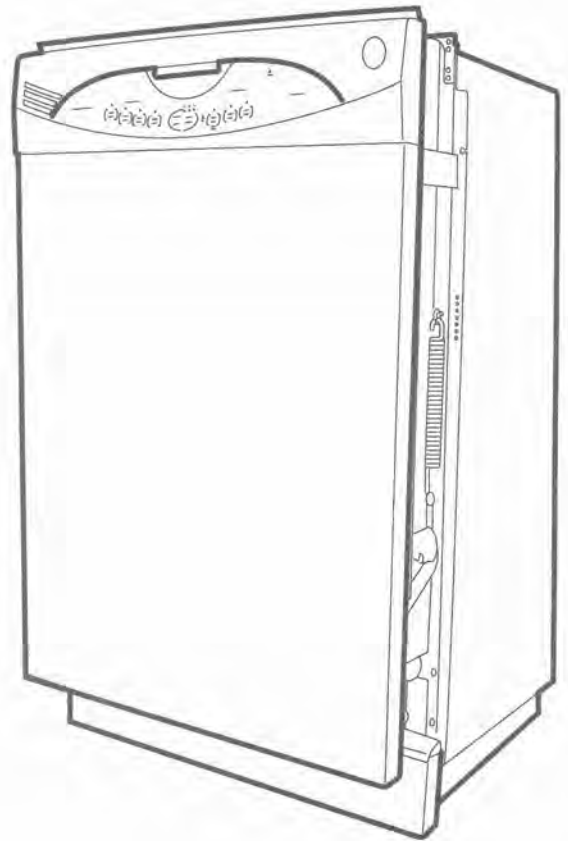

31-9138



GE Appliances
General Electric Company
Louisville, Kentucky 40225



IMPORTANT SAFETY NOTICE

The information in this service guide is intended for use by individuals possessing adequate backgrounds of electrical, electronic, and mechanical experience. Any attempt to repair a major appliance may result in personal injury and property damage. The manufacturer or seller cannot be responsible for the interpretation of this information, nor can it assume any liability in connection with its use.

WARNING

To avoid personal injury, disconnect power before servicing this product. If electrical power is required for diagnosis or test purposes, disconnect the power immediately after performing the necessary checks.

RECONNECT ALL GROUNDING DEVICES

If grounding wires, screws, straps, clips, nuts, or washers used to complete a path to ground are removed for service, they must be returned to their original position and properly fastened.

GE Consumer & Industrial
Technical Service Guide
Copyright © 2006

All rights reserved. This service guide may not be reproduced in whole or in part in any form without written permission from the General Electric Company.

Table of Contents

Bottom Door Seal	19
Component Locator Views.....	8
Control Assembly.....	12
Control Features.....	6
Control Panel	11
Detergent/Rinse Module.....	16
Diagnostics and Service Information.....	28
Dishwasher Components.....	11
Door Assembly.....	17
Door Latch and Release Assembly.....	13
Door Panel.....	11
Door Switch Assembly	15
Drain Pump Assembly.....	24
Fill Funnel.....	21
Heating Element.....	19
Introduction.....	5
Nomenclature	4
Pressure Switch	23
Schematics and Wiring Diagrams.....	30
Service Test Mode.....	28
Specifications	28
Static Dry System.....	12
Sump Assembly.....	27
Thermistor.....	26
Troubleshooting	29
Tub Seal.....	18
Warranty	31
Wash Pump Assembly	25
Water Inlet Valve.....	22

Nomenclature

Model Number

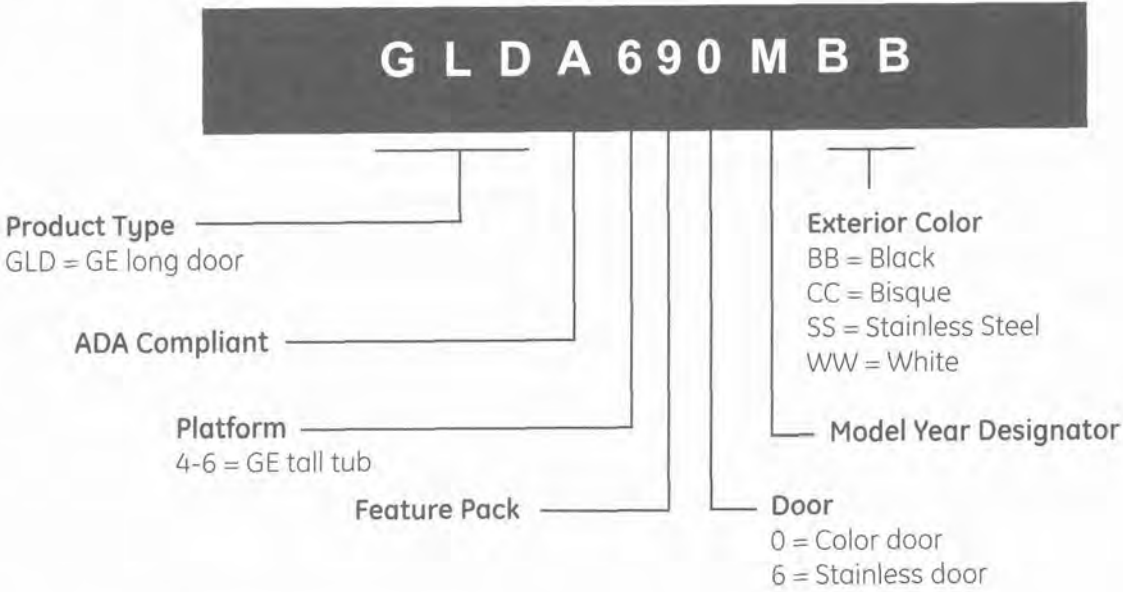

The nomenclature plate is located on the left side of the tub wall, inside the door jamb.

The mini-manual is located in a plastic bag taped behind the toe kick.

Serial Number

The first two characters of the serial number identify the month and year of manufacture.
Example: **AL123456S** = January, 2006

A - JAN	2006 - L
D - FEB	2005 - H
F - MAR	2004 - G
G - APR	2003 - F
H - MAY	2002 - D
L - JUN	2001 - A
M - JUL	2000 - Z
R - AUG	1999 - V
S - SEP	1998 - T
T - OCT	1997 - S
V - NOV	1996 - R
Z - DEC	1995 - M

The letter designating the year repeats every 12 years.

Example:
T - 1974
T - 1986
T - 1998

Introduction

	GLDA690MWW	GLDA696MSS
FEATURES		
ADA Compliant	Yes	Yes
Door Style	Long door/Tall tub	Long door/Tall tub
Energy Star® Qualified	Yes	Yes
Tub and Door Liner	Stainless Steel	Stainless Steel
Control Type	Electronic Light-Touch	Electronic Light-Touch
Automatic Temperature Control	Yes	Yes
Automatic Temperature Sensing	Yes	Yes
Dual Pumps and Motors	Yes	Yes
Last Cycle Memory	Yes	Yes
Wash Arms	3-Direct Feed	3-Direct Feed
Wash Levels	6	6
Water Filtration System	100% Water Filtration	100% Water Filtration
Cycles / Options	4/4	4/4
Light Wash	Yes	Yes
Normal Wash	Yes	Yes
Pots & Pans	Yes	Yes
Rinse Only	Yes	Yes
Delay Start	2/4/8-Hr.	2/4/8-Hr.
Heated Dry On/Off	Yes	Yes
Hot Wash	Yes	Yes
HotStart™	Yes	Yes
Lock Pad	Yes	Yes
Start / Cancel / Reset Pad	Yes	Yes
Cup Shelf	2 Plastic with 1 StemSafe™	2 Plastic with 1 StemSafe™
Lower Rack	Deluxe Towerless	Deluxe Towerless
Silverware Basket	1 Piece Super with 1 Cell Cover	1 Piece Super with 1 Cell Cover
Upper Rack	Tiered	Tiered
Cycle Countdown	2 Digit Display	2 Digit Display
Touchpads / Knobs	9 Touchpads	9 Touchpads
120 ° Inlet Water Capability	Yes	Yes
Calrod Heater	Multi-Wattage	Multi-Wattage
ECONOMICAL / QUIET		
Door Insulation and Bitumen	Yes	Yes
Outer Wrap	Full-wrap Blanket	Full-wrap Blanket
QuietPower™ Motor	Yes	Yes
Sound Insulation Package	QuietPower™ 3 58 dBA	QuietPower™ 3 58 dBA
Stainless Steel Interior	Yes	Yes
Tub Collar Trim	Yes	Yes
APPEARANCE		
Installation	Built-In	Built-In
Color Appearance	"WW" "BB" "CC"	Stainless Steel
Control Color / Style	"WW" "BB" "CC" / Electronic	Black / Electronic
WEIGHTS & DIMENSIONS		
Approximate Shipping Weight	100 lb	100 lb
Net Weight (lbs.)	95 lb	95 lb
Overall Depth	24 in	24 in
Overall Height	32.35 in	32.35 in
Overall Height With Legs Extended (In.)	34.5	34.5
Overall Width	24 in	24 in
POWER / RATINGS		
Calrod Heater Watts	875 Max.	875 Max.
Volts/Hertz/Amps	120V 60 Hz 9.1 A	120V 60 Hz 9.1 A
WARRANTY		
Parts Warranty	Limited 1-year entire appliance	Limited 1-year entire appliance
Labor Warranty	Limited 1-year entire appliance	Limited 1-year entire appliance

Control Features

Throughout this manual, features and appearance may vary from your model.

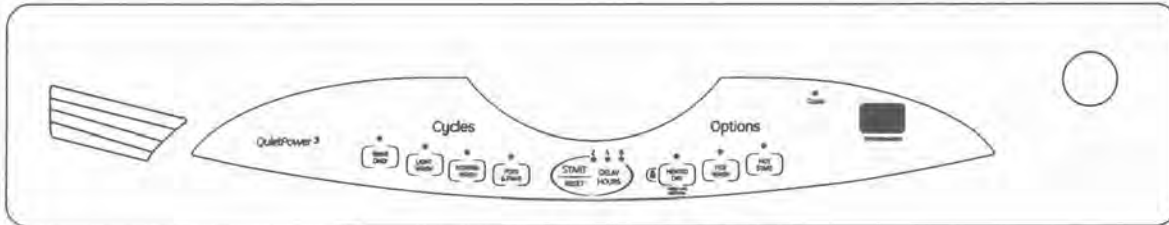

Control Settings

Wash Cycles

POTS & PANS	For heavily soiled dishes or cookware with dried-on or baked-on soils. Everyday dishes may be included. This cycle will not remove burned-on foods.
NORMAL WASH	For loads of everyday dishes, glasses and cookware with medium soils. NOTE: Many dishes have lighter soil than normal. Choosing a cycle other than NORMAL WASH will save energy and water.
LIGHT WASH	For dishes with light soils.
RINSE ONLY	For rinsing partial loads that will be washed later. DO NOT use detergent or HEATED DRY OPTION .

Options

HEATED DRY ON	Turns the heating element on for fast drying. This option will extend the time of your wash cycle.
HEATED DRY OFF	Turns HEATED DRY ON Off. Dishes air dry naturally and energy is saved.
HOT WASH	Turns HOT WASH ON Off. Wash temperature will be a little higher.
HOT START	Turns HOT START ON Off. Wash time will be a little longer, and initial wash temperature will be higher.
DELAY HOURS	You can select 2, 4 or 8 hours later to start dishwasher.

About the dishwasher control panel.

Cycle Sequence

<i>Cycles</i>	<i>Water (approx.)</i>	<i>Time (approx.)</i>	<i>Cycle Sequence</i>									
POTS & PANS	7.4 gal.	85 min.	Rinse	Rinse	Rinse	Rinse	Rinse	Wash	Rinse	Rinse		
NORMAL WASH	5.3 gal.	56 min.			Rinse	Rinse	Rinse	Wash	Rinse	Rinse		
LIGHT WASH	4.2 gal.	33 min.				Rinse	Rinse	Wash	Rinse	Rinse		
RINSE ONLY	2.1 gal.	7 min.							Rinse	Rinse		

<i>Drying Options</i>	
HEATED DRY ON	Adds approximately 38 minutes to the cycle. (Not available on the RINSE ONLY cycle.)

<i>HEATED WASH Options</i>	
HEATED WASH ON	Adds approximately 15 minutes to the main wash cycle. Energizes heater during main wash cycle. (Not available on the RINSE ONLY cycle.)

<i>HEATED START Options</i>	
HEATED START ON	Adds approximately 22 minutes to the cycle by adding 2 pre-rinses. The first is a normal pre-rinse to purge the water supply lines. The second pre-rinse lasts 15 minutes with the heater energized to heat the tub and dishware. (Not available on the RINSE ONLY cycle.)

Component Locator Views

Front View

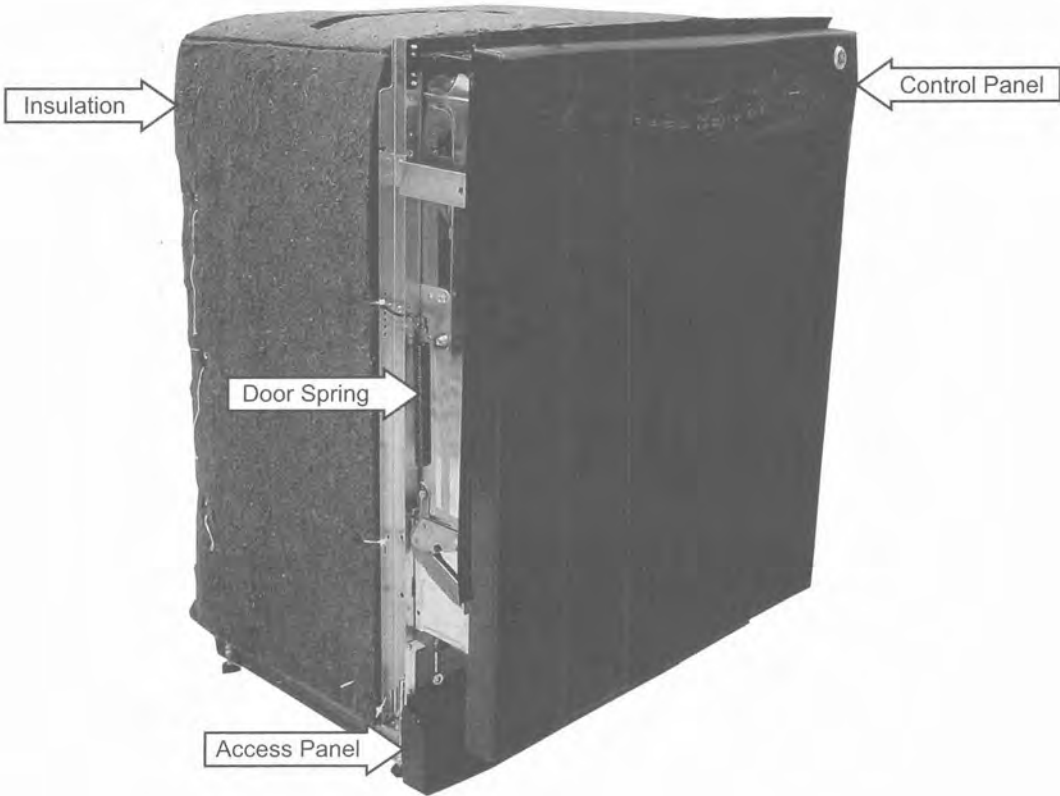

Control Panel View

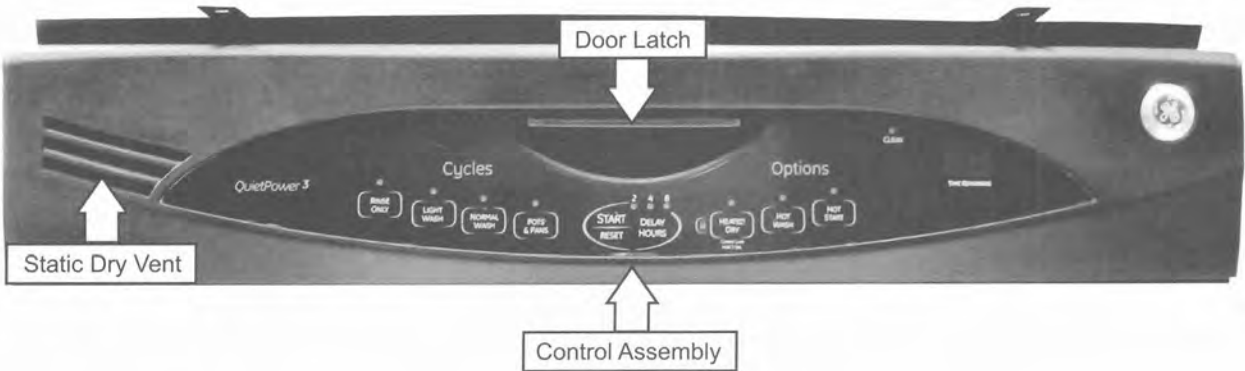

Interior View (With Racks)

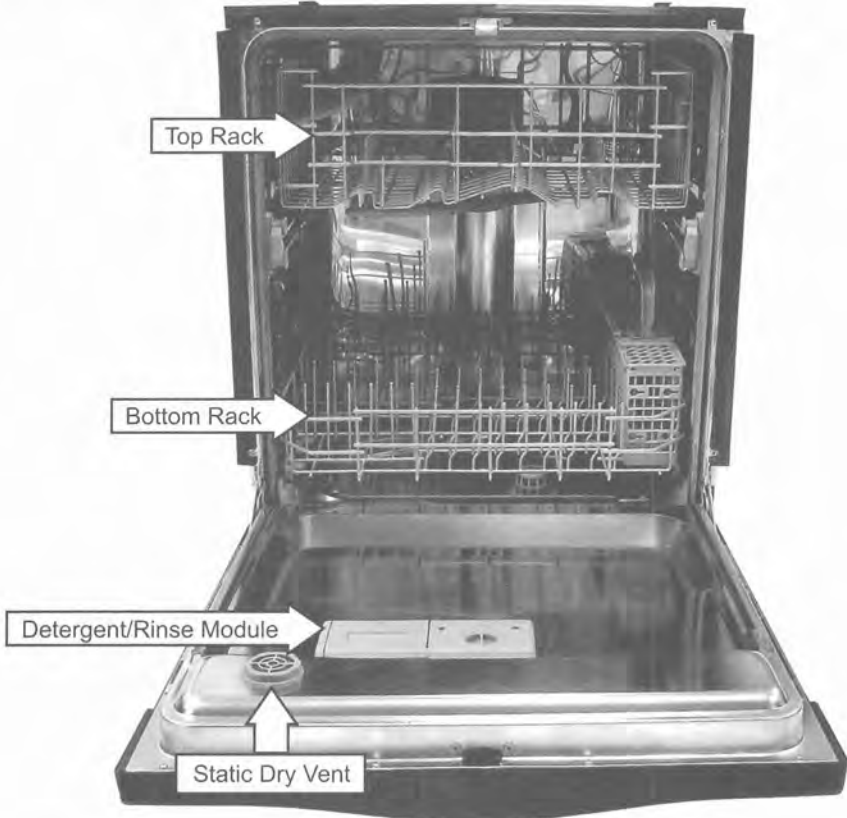

Detergent/Rinse Module Compartment View

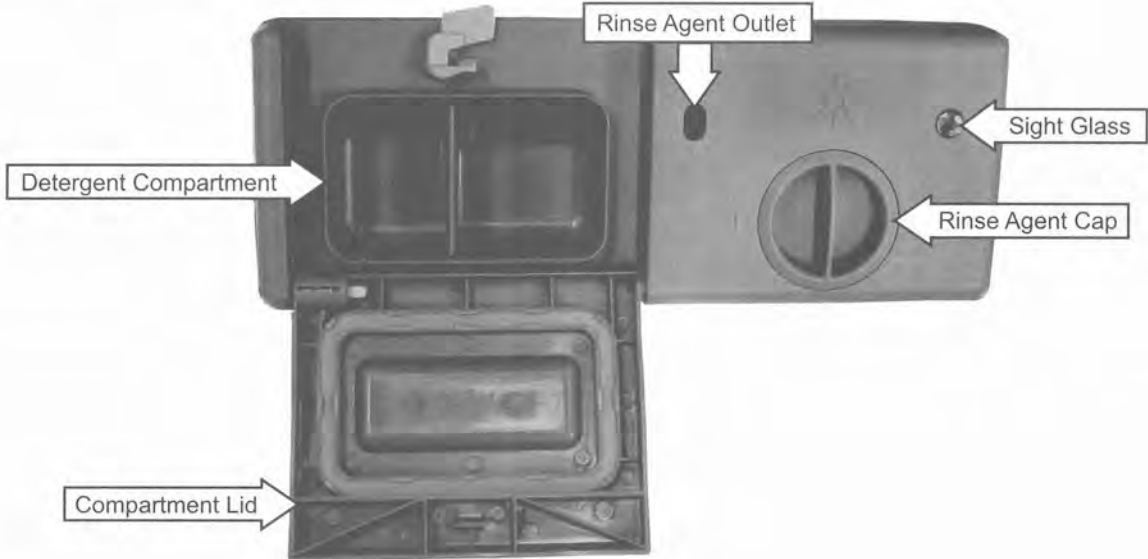

Interior View of Basin (With Racks Removed)

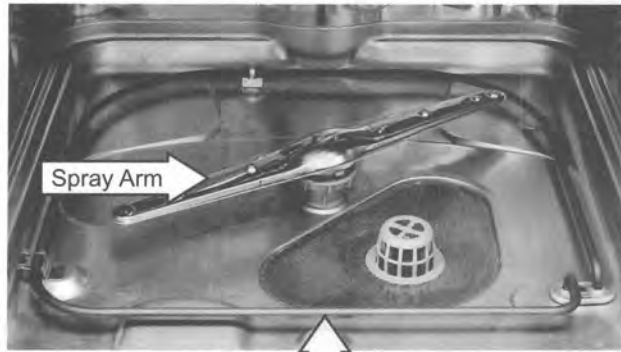

Heating Element

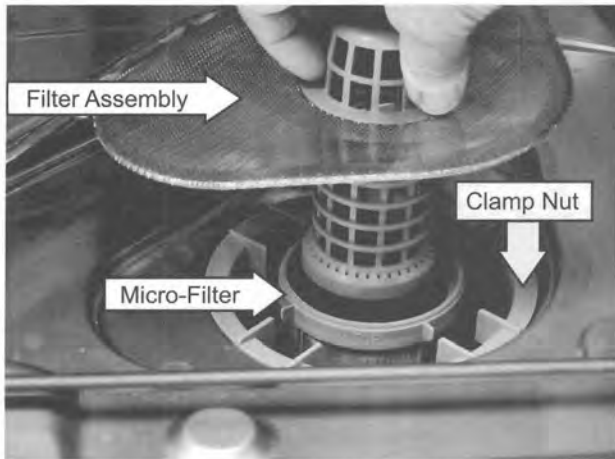

Filter Assembly

Clamp Nut

Micro-Filter

Right Side View (Insulation Removed)

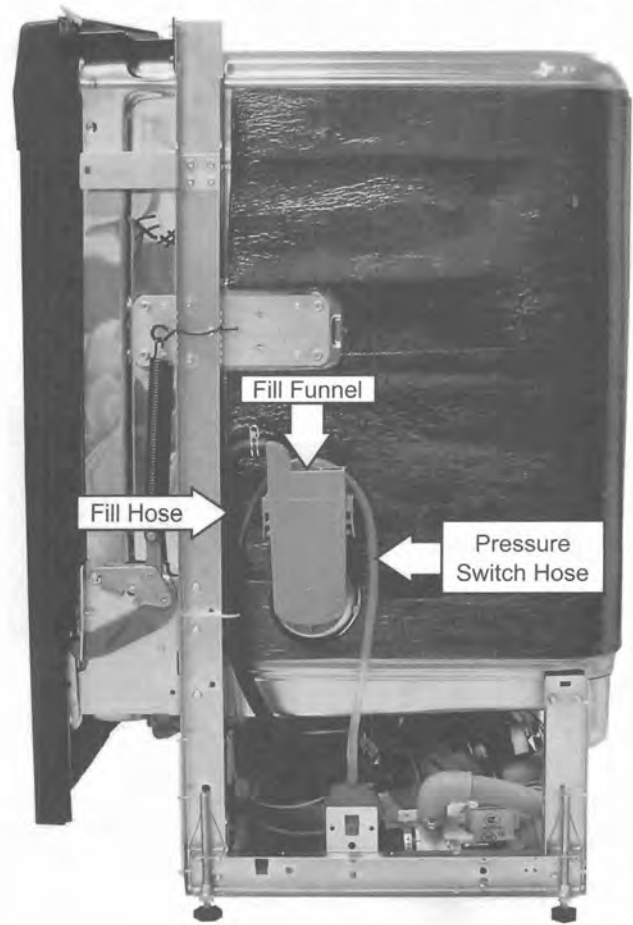

Fill Funnel

Fill Hose

Pressure Switch Hose

Bottom View (Looking Up)

Front

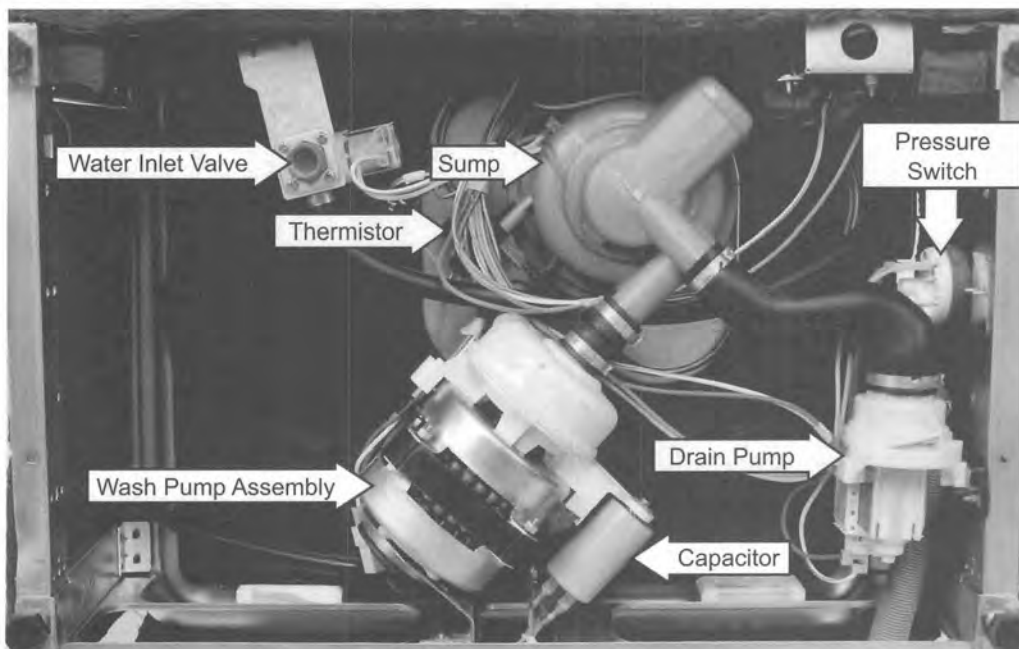

Water Inlet Valve

Sump

Thermistor

Wash Pump Assembly

Drain Pump

Capacitor

Pressure Switch

Back

Dishwasher Components

Door Panel

The door panel covers the door to the dishwasher and must be removed to access the control panel, detergent/rinse module, bottom door seal, and heating element.

To remove the door panel, remove 6 Phillips-head screws, then lower the door panel from the control panel.



Control Panel

To remove the control panel:

1. Remove the door panel. (See **Door Panel**.)
2. Turn the static dry vent cover counterclockwise and remove it.



3. Remove the six 3/4-in. long Phillips-head screws that attach the control panel to the door assembly.

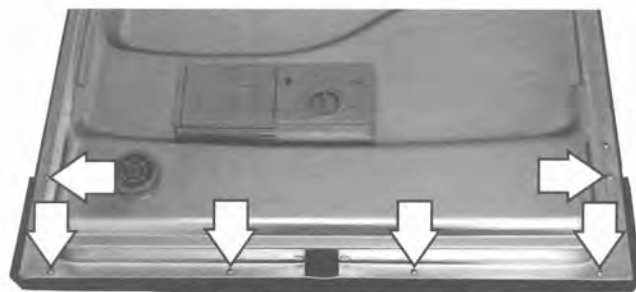

4. Disconnect the 3 wire harnesses from the control module.

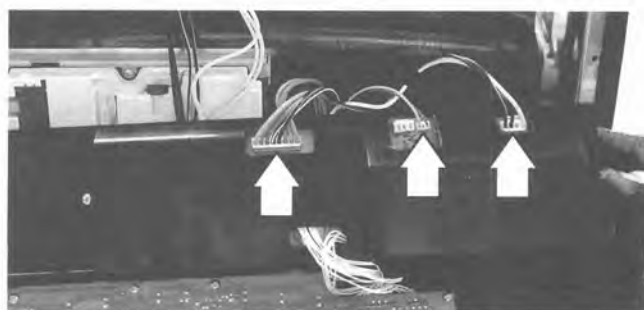

Static Dry System

The static dry system operates through a vent located in the control panel. The vent allows hot air to exit the dishwasher tub and gradually remove moisture.

To remove the vent it will be necessary to access the control panel. (See **Control Panel** steps 1 through 3.)

The vent is pressed in place over an anchor pin and positioned in the vent outlet recess located on the inside of the control panel.

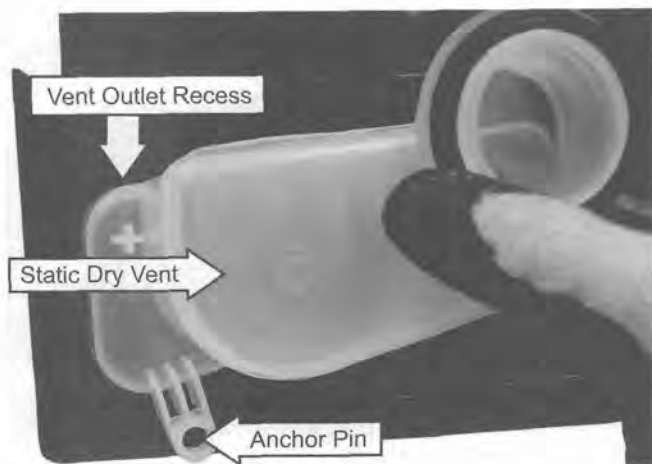

Note:

- Inspect the cover for hard water/lime deposits or debris and clean if necessary.
- If the control panel gasket shows obvious signs of wear or damage, replace the gasket.
- If the vent cover O-Ring shows obvious signs of wear or damage, replace the static dry vent.



Control Assembly

The control assembly consists of the control circuit board, control module, and module cover.

To remove the control assembly:

1. Remove the static dry vent cover. (See **Static Dry System**.)
2. Remove the 12 Phillips-head screws that attach the control circuit board to the control panel.

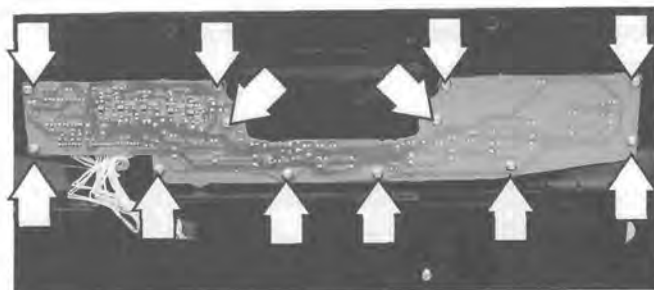

3. Remove the 2 Phillips-head screws that hold the control module cover to the control panel.



- Remove the 6 Phillips-head screws from the control module.
- Release the 2 top tabs and remove the control module from the bottom 3 retainers.

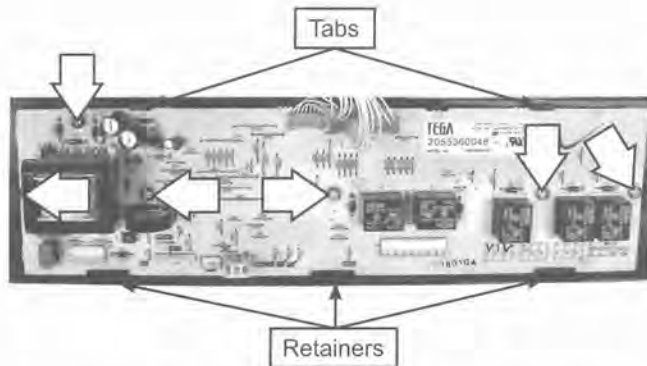

Note: Wiring harness on the control assembly does not disconnect. Control assembly must be replaced as a unit.

- Remove the control circuit board, control module, and control module cover.

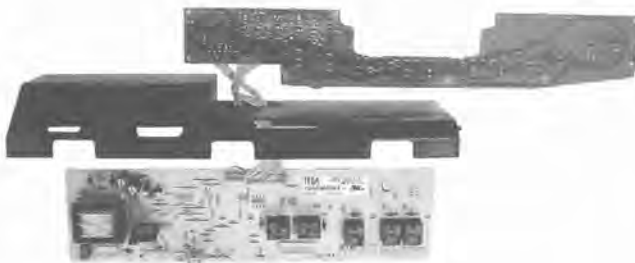

Door Latch and Release Assembly

The door latch is permanently mounted to the top of the dishwasher and is not replaceable. When the door is in the closed position, the door latch has dropped into place in front of the door switch housing assembly and has pressed the switch plunger down. This action holds the door firmly against the seal, and the normally open contacts of the door switches are closed.

The door release assembly is located on the inside of the control panel. When the release handle is pressed upward, it raises the door latch to clear the front of the door switch housing assembly, releasing the door.

To remove the door release assembly it will be necessary to access the control panel. (See **Control Panel** steps 1 through 3.) The door release is held to the control panel with 2 Phillips-head screws.

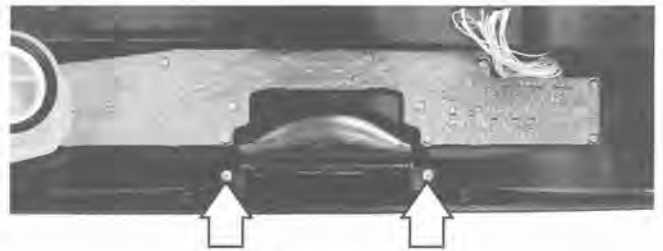

Caution: The door latch assembly may come apart. Use care to assure the latch spring is not lost during removal, handling, or installation.

To reassemble and reinstall the door latch assembly:

- Slide the latch spring onto the latch-block hinge pin and hook the spring into the hole in the latch block.

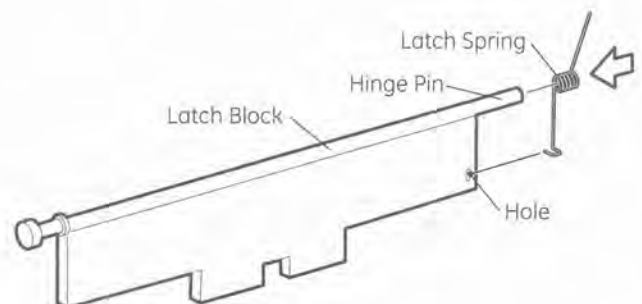

2. Snap the latch block into the latch bracket making sure the spring arm rests in the channel in the latch bracket.

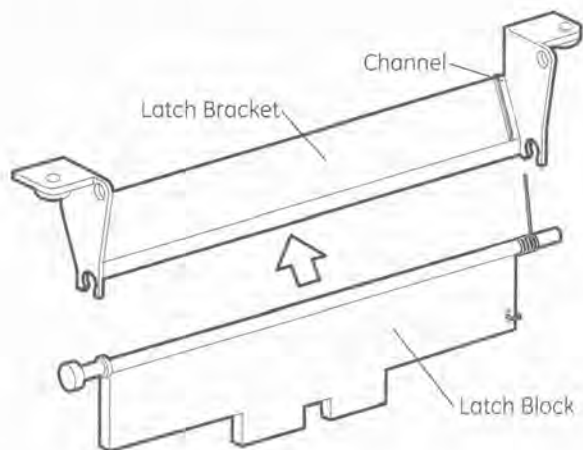

3. Rotate the latch block to compress the spring.

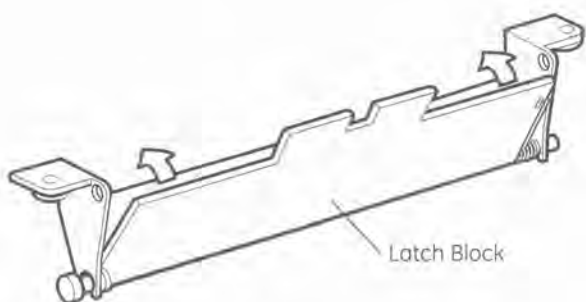

4. With the raised center bar of the latch handle toward the latch block, insert the latch handle hinge pins into the holes in the latch bracket.

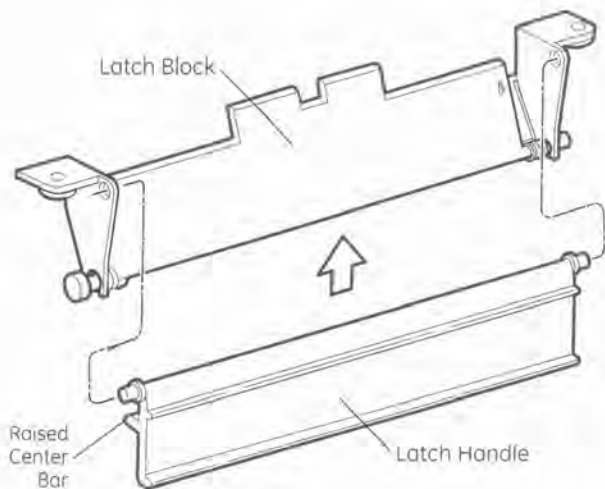

5. Insert this latch assembly, including the handle, into the escutcheon cutout with the latch handle side toward the bottom of the escutcheon.
6. Assure that the top rib of the handle is tucked under the top edge of the cutout and attach the assembly with 2 Phillips-head screws.

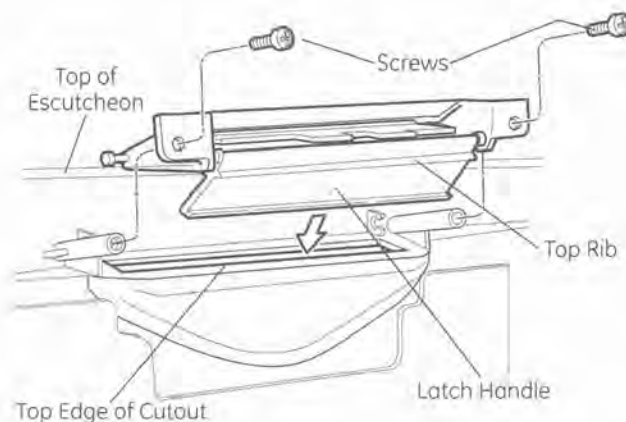

Door Switch Assembly

The door switch assembly consists of 2 switches activated by a spring loaded plunger. One door switch connects or disconnects the Line (hot) side of 120 VAC. The other switch connects or disconnects the Neutral side of 120 VAC. When the door is in the closed position, the door latch has dropped into place in front of the door switch assembly and has pressed the switch plunger down. This action holds the door firmly against the seal, and the normally open contacts of the door switches are closed.

To remove the door switch assembly:

1. Remove the control panel. (See *Control Panel*.)
2. Remove the 2 Phillips-head screws that hold the door switch assembly to the top of the door.

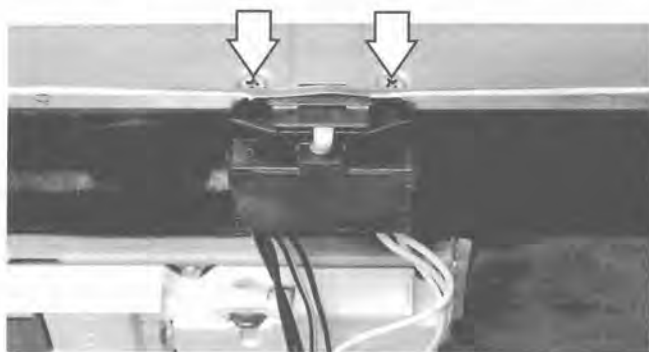

3. Using a small flat-blade screwdriver, lift the door switch cover at the 2 tabs on each side, the 2 inner tabs, and the bottom tab.



Caution: When removing the plunger, the spring is not secured and will pop off. To secure, place your hand over the spring when removing the plunger.

4. Remove the plunger and the spring.

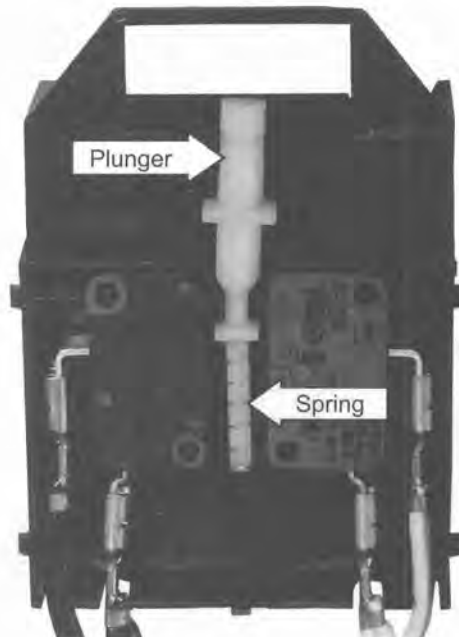

5. Lift up the interlock switches to remove. These switches are replaceable (Part # WD21X10224).

Note:

- Upon reassembly, ensure that the notched side of the plunger is placed towards the plunger guide in the switch housing.
- Ensure that the bottom of the spring is positioned on top of the bottom guide, and that the plunger slides freely.

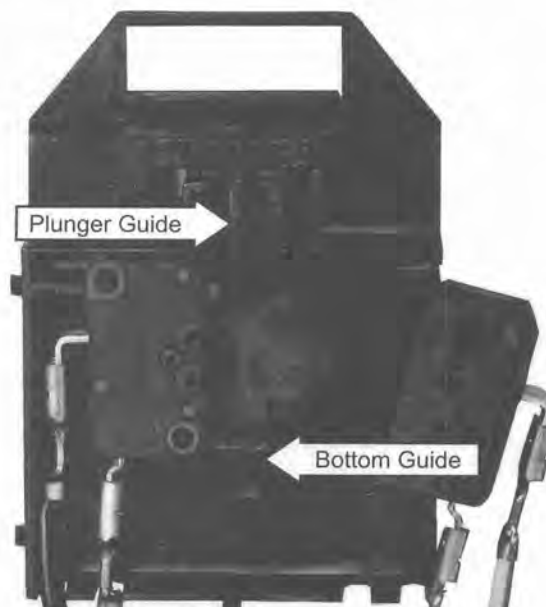

Detergent/Rinse Module

The control panel must be removed to access the detergent/rinse module. (See **Control Panel**.)

The detergent/rinse module is connected by 2 wires and held in place by 6 Phillips head screws and 2 brackets.

The detergent/rinse module operates on 120 VAC and has an approximate resistance value of 2.6K Ω .

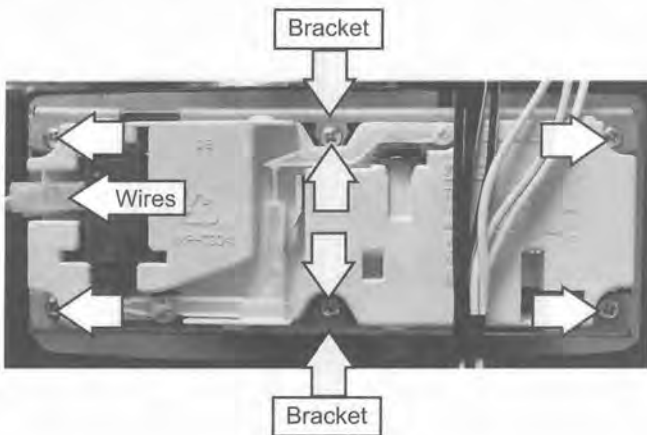

The detergent/rinse module automatically dispenses both the detergent and the rinse agent at the appropriate times. The module is activated 2 times during a wash cycle. Detergent is dispensed at the beginning of the main wash cycle and rinse agent at the beginning of the final rinse.

Operation of the detergent/rinse module can be checked by using the service test mode. (See **Service Test Mode**.)

The first time the module is activated, the lever slides up the right-hand path of the connecting rod (1). This action releases the detergent cover.

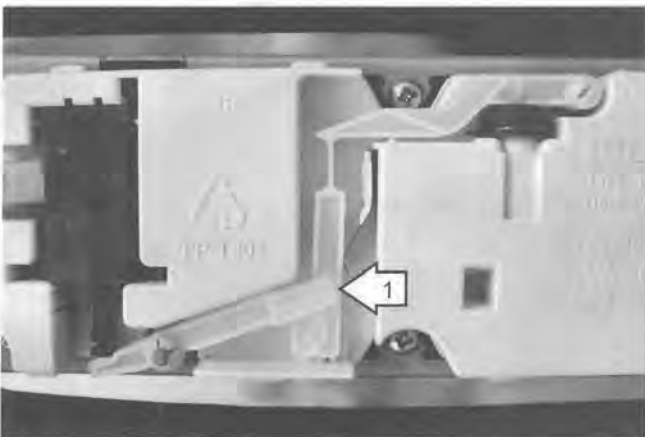

When deactivated, the lever returns down the left-hand path and comes to rest under the notch (2) in the center of the connecting rod.

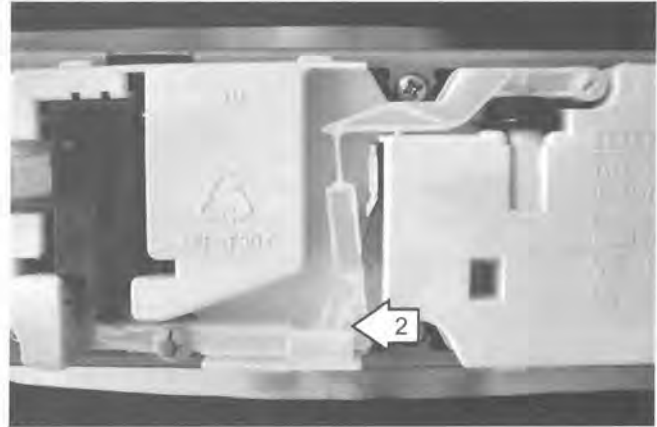

At the second activation, the lever lifts the connecting rod by the notch. This action lifts the rinse dispenser plunger (3) and releases the rinse agent. When deactivated, the lever returns to its original starting position.

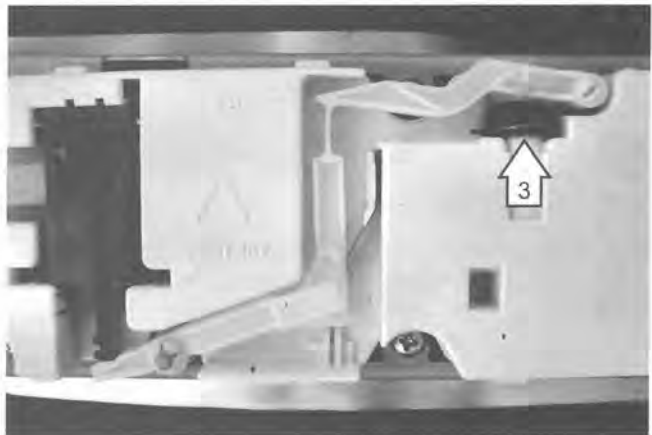

Note: Make sure the rubber seal is retained in the recessed groove before reinstalling the module to the door assembly.



Door Assembly

To remove the door assembly:

1. Disconnect power.
2. Partially remove the dishwasher from its installation to access the door springs.
3. Remove the control panel. (See *Control Panel*.)
4. Remove the detergent/rinse module. (See *Detergent/Rinse Module*.)
5. Remove the door latch assembly. (See *Door Latch Assembly*.)
6. Remove the thermistor wires from the tape attached to the door panel.
7. Remove the 8-mm nut, Phillips-head screw, and ground wire from the right side door hinge assembly.

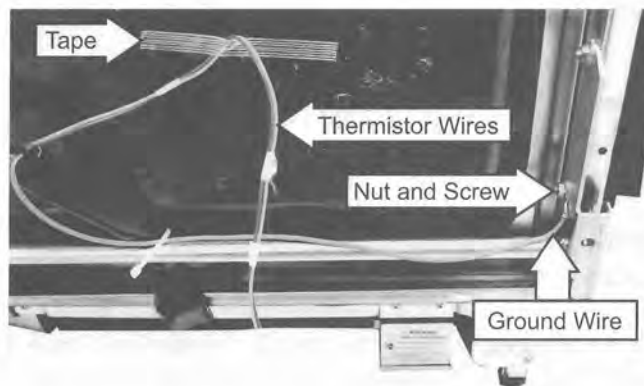

Note: The following describes the procedure to remove the right side of the door assembly from the hinge assembly. The procedure to remove the left side is identical.

8. Mark the position of the spring bolt key in the mounting bracket with a felt-tip marker.

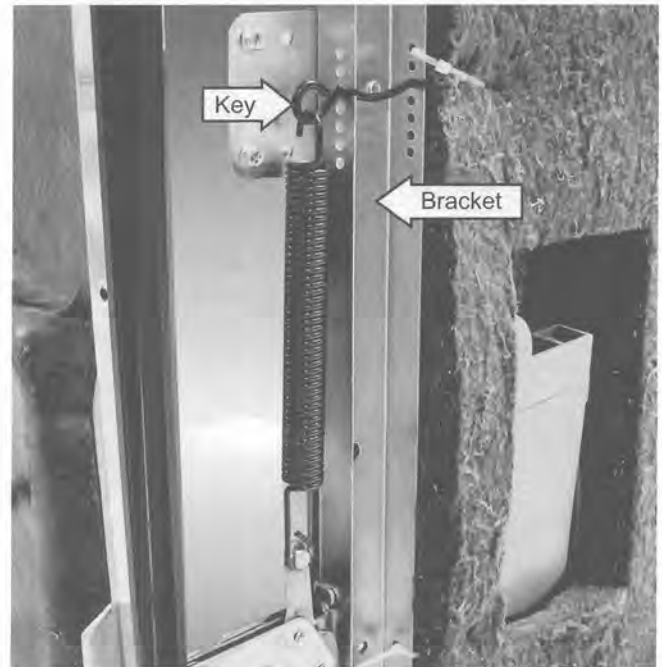

Caution: When one or both of the door springs are disconnected, the door may fall to the floor. Care must be taken to prevent damage to the door.

9. Pull the spring and spring bolt key from the mounting bracket.
10. Remove the bottom of the spring loop from the hinge arm stud.

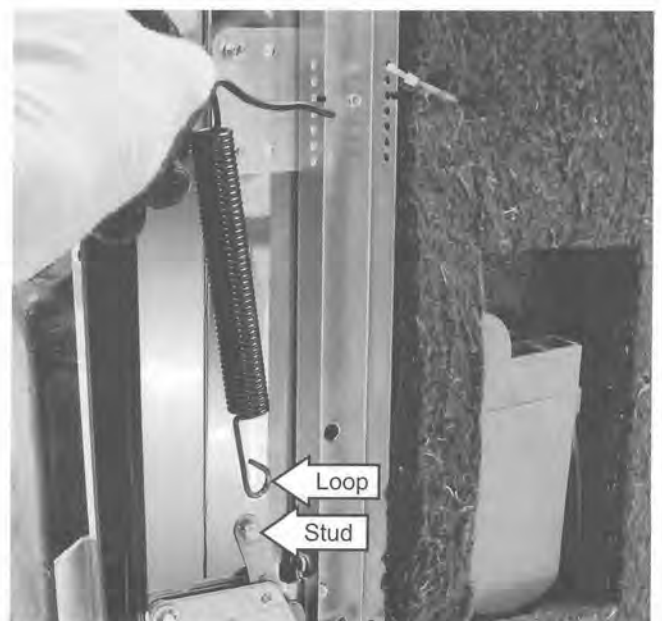

11. Open the dishwasher door approximately 30 degrees.
12. Lift the bottom hinge arm up from the bottom hinge, far enough to expose the hook.

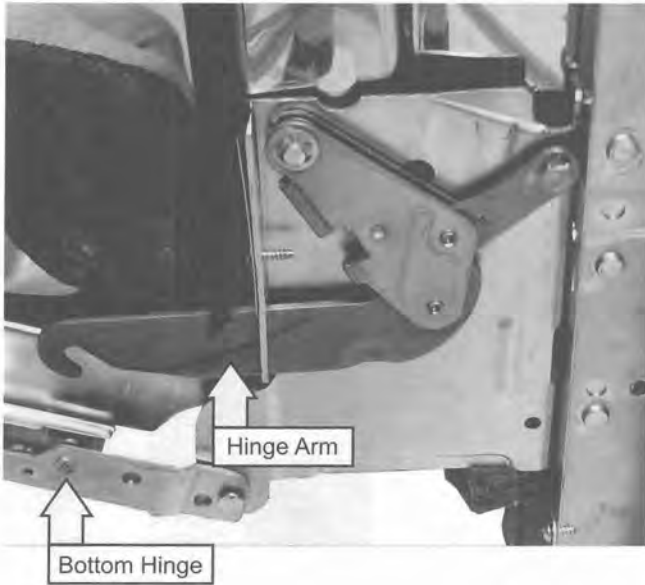

13. Position hinge arm assembly to hang freely as shown.

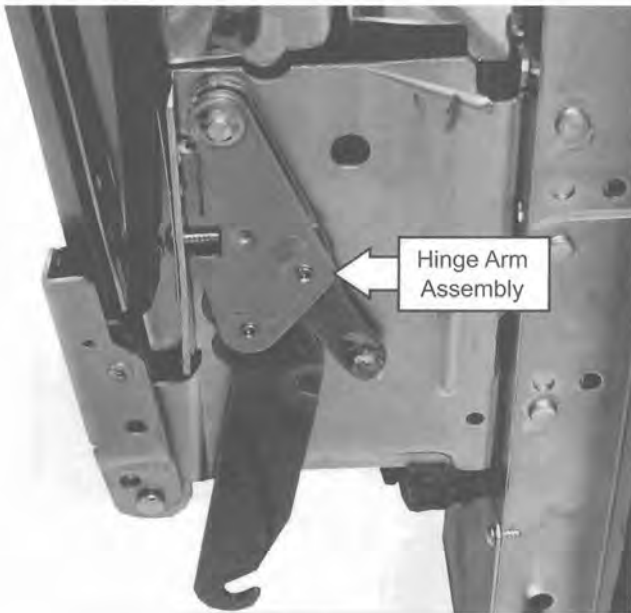

14. Repeat steps 8 through 13 on the left side of the door panel.
15. Remove the remaining three 8-mm nuts and Phillips-head screws that hold the door panel to the hinge assembly.

Tub Seal

The dishwasher tub seal prevents water leakage. The seal is fitted in a seal channel that lines the rim of the dishwasher tub.

To remove the tub seal:

1. Open the dishwasher door.
2. Grasp one end of the dishwasher tub seal and peel it away from the seal channel.

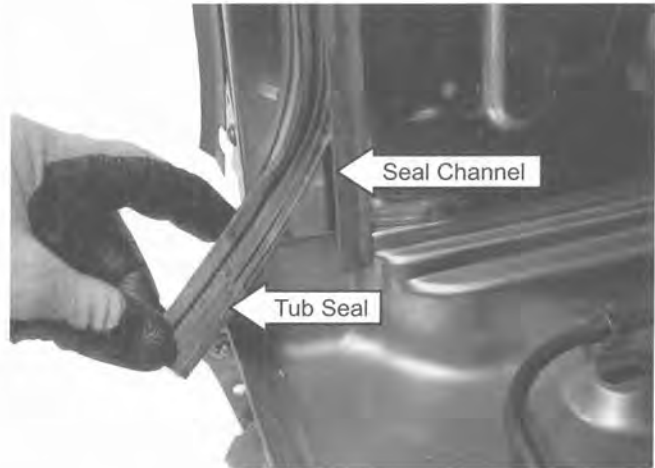

3. Reverse the above procedure to install.

Note: When installing the tub seal, make sure it is seated properly in the seal channel. Run your finger over the seal to make sure it is smooth and even for a proper seal. A correctly installed gasket will have both ends of the gasket equidistant from the bottom of the tub.



Bottom Door Seal

The bottom door seal prevents water leakage. The seal is fitted in a pinched metal groove at the bottom of the dishwasher door.

WARNING: The pinched metal groove is sharp. Wear Kevlar gloves when removing or installing the bottom door seal. Failure to comply may result in personal injury.

It is necessary to remove the door assembly to access the bottom door seal. (See **Door Assembly**.) The seal is pulled out from the pinched metal groove.

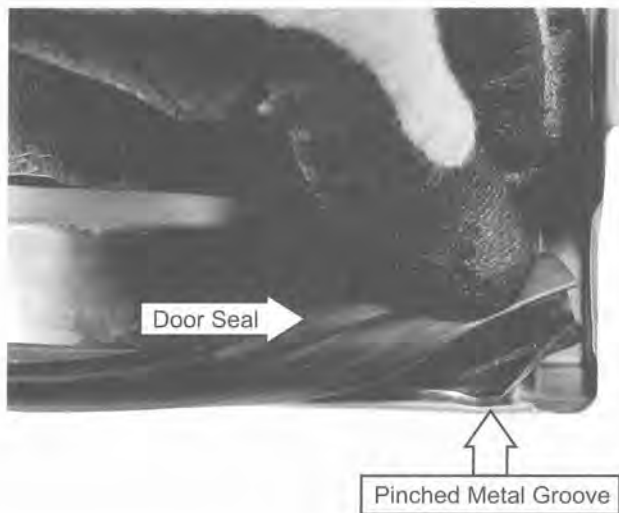

To install the bottom door seal it will be necessary to open the pinched metal groove. Make sure the seal is seated properly in the metal groove before pinching closed. Run your finger over the groove to make sure it is smooth and even for a proper seal.

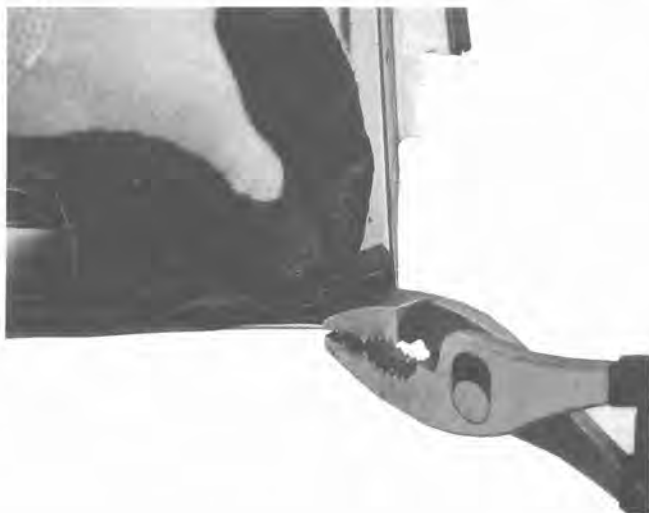

Heating Element

The heating element maintains water temperature during the wash and rinse cycles and heats the air during the static dry cycle.

The heater has an approximate resistance value of 21.2 Ω .

Operation of the heating element can be checked by using the service test mode. (See **Service Test Mode**.) Allow one or two minutes before opening the dishwasher door and note if heat is present.

To remove the heating element:

1. Remove the door panel. (See **Door Panel**.)
2. Remove the bottom rack.
3. Remove the 2 Phillips head screws, washers, and the access panel.

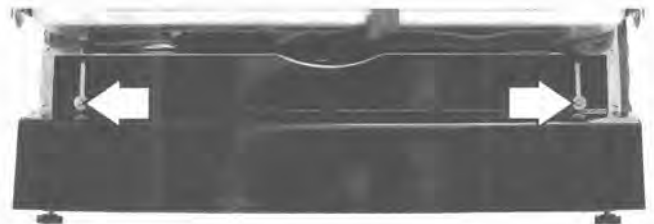

4. Remove the 2 Phillips-head screws and lower the water valve from the front brace.
5. Remove the 2 Phillips-head screws and lower the junction box from the front brace.

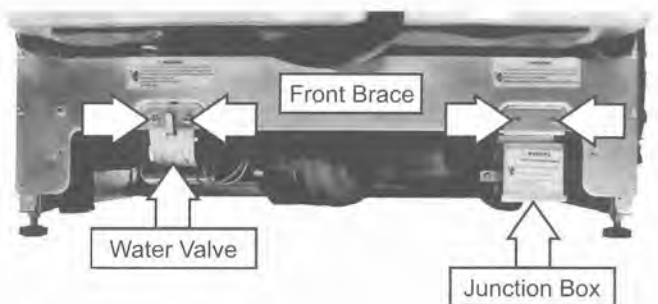

6. Remove the 6 Phillips-head screws and the front brace from the dishwasher.



7. Locate the wires leading to the heating element terminals and pull down the 2 nylon terminal covers.
8. Disconnect the 2 wires from the heating element.

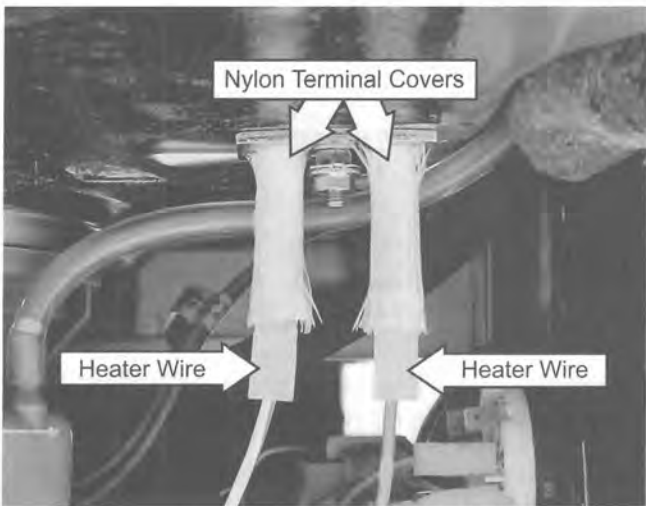

9. Remove the outer 8 mm nut that attaches the ground wire to the element mounting bolt.

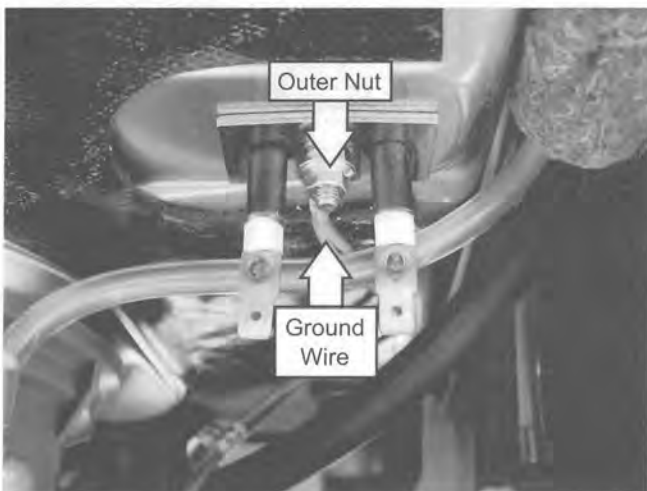

10. Remove the inner 8 mm nut, washer, and spacer that attaches the element to the bottom of the tub.

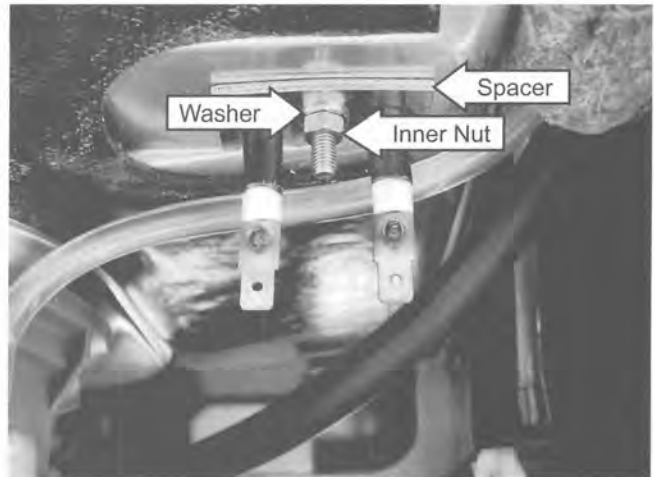

11. Lift the right side of the element and release it from the 2 retainers.



Fill Funnel

The fill funnel is mounted on the right side of the tub. Its purpose is to provide a method of supplying water for the wash and rinse cycles. The air gap prevents the siphoning of wash water from flowing back into the water supply system, should the water pressure drop to less than atmospheric pressure. The fill funnel also allows air into the tub to permit airflow for drying dishware.

To remove the fill funnel:

1. Disconnect power.
2. To access the fill funnel, carefully pull the dishwasher out from its installation.
3. Open the dishwasher door.
4. Rotate the fill funnel cap counterclockwise and remove it from the fill funnel threads.

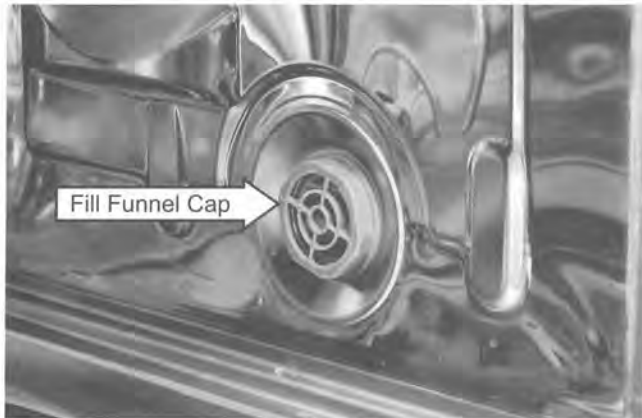

1. Loosen the clamp and disconnect the fill funnel hose from the fill funnel.

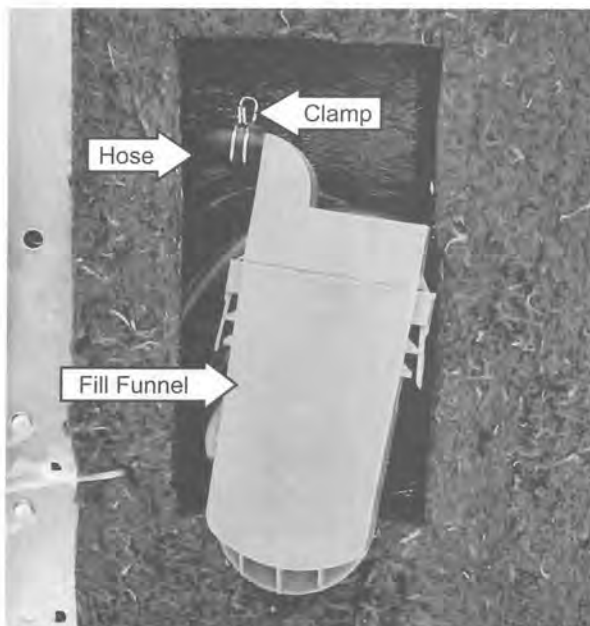

Note:

- Ensure the diverter is fully seated in the bottom of the fill funnel with the tab toward the bottom of the guides.

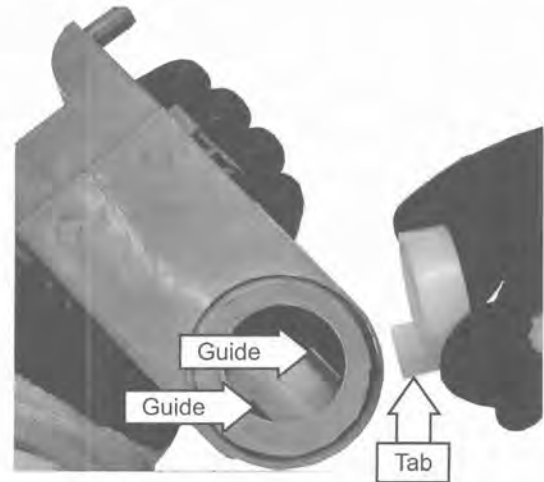

- Upon assembly, ensure the fill funnel gasket is placed over the fill funnel threads.
- Upon assembly, make sure that the clear plastic air tube is looped around that part of the fill funnel that protrudes into the dishwasher tub and mates with the fill funnel cap. (See photo below.)



Water Inlet Valve

The water inlet valve is electronically controlled and solenoid operated. The flow of water is controlled by a rubber flow washer capable of maintaining a flow rate of $1.8 \pm 14\%$ gallons per minute ($6.81 \pm 14\%$ liters per minute) with incoming water pressure of 20 to 120 PSI. The water valve is mounted on a bracket located on the left side of the front brace.

The water valve has an approximate resistance value of 1036Ω and is energized for approximately 36 seconds during each fill.

Operation of the water valve can be checked by using the service test mode. (See **Service Test Mode**.)

To remove the water valve:

1. Disconnect power.
2. Remove the 2 Phillips head screws, washers, and the access panel.



3. Disconnect the water supply line from the fill valve inlet.
4. Remove the 2 Phillips-head screws that hold the bracket to the front brace.
5. Disconnect the 2 wires from the solenoid.

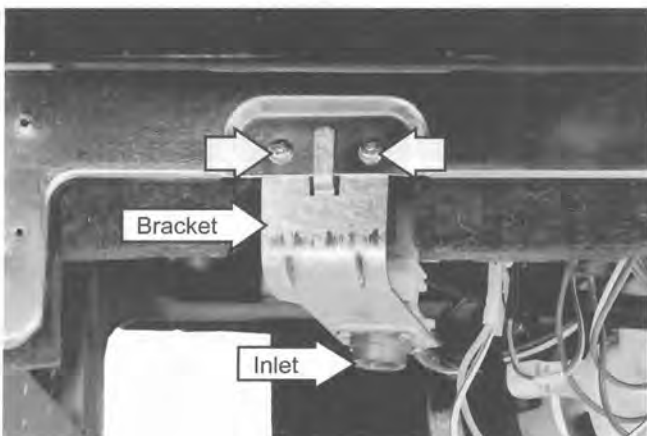

Caution: The clamp is easily damaged during removal and should not be reused. Use the screw-type hose clamp provided with the new valve.

6. Remove the clamp and the outlet hose from the valve.

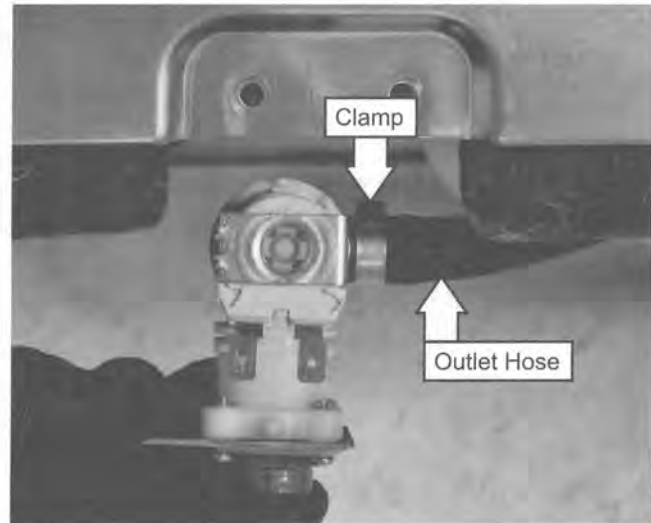

7. Remove the 4 Phillips-head screws and the fill valve from the bracket.

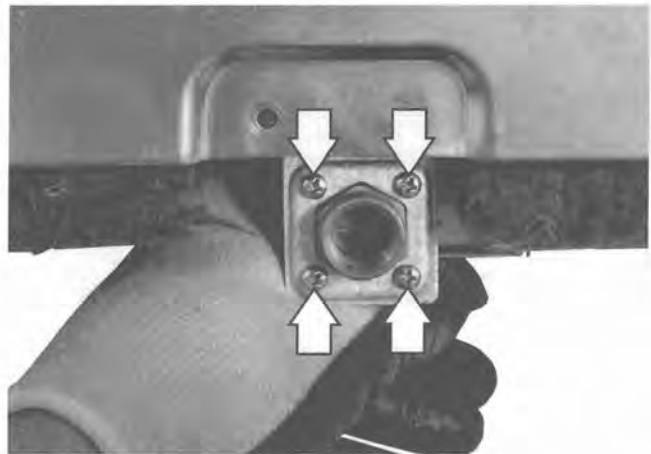

Note: Ensure the O-ring is retained in the valve upon reassembly.



Pressure Switch

The pressure switch is an overflow safety device mounted on a bracket located under the tub near the right front corner. A clear plastic tube (the pressure switch hose) runs from the pressure switch, around the fill funnel, and to the sump.

As the dishwasher basin fills with water, the air pressure in the pressure switch hose increases. Normally, the electronic control regulates the amount of time the water fill valve remains open. If the water fill valve remains energized, the overfilling of the basin increases the air pressure in the pressure switch hose, causing the pressure switch to open the circuit to the water valve.

To remove the pressure switch:

1. Disconnect power.
2. Remove the front panel. (See *Front Panel*.)
3. Remove the 2 Phillips head screws, washers, and the access panel.



4. Remove the 2 Phillips-head screws that attach the water valve and the junction box to the front brace and lower each towards the floor.

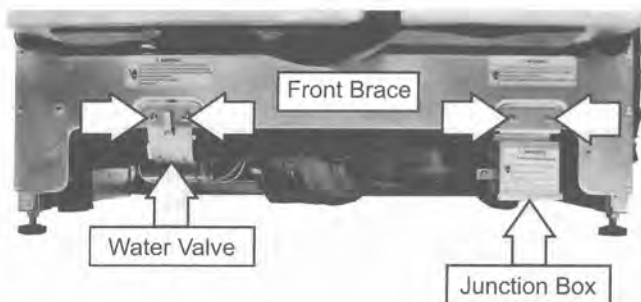

5. Remove the 6 Phillips-head screws and the front brace from the dishwasher.



6. Disconnect the pink wire from terminal 1 and the yellow wire from terminal 2.

Note: Terminal 3 not used.

7. Remove the pressure switch hose from the pressure switch.

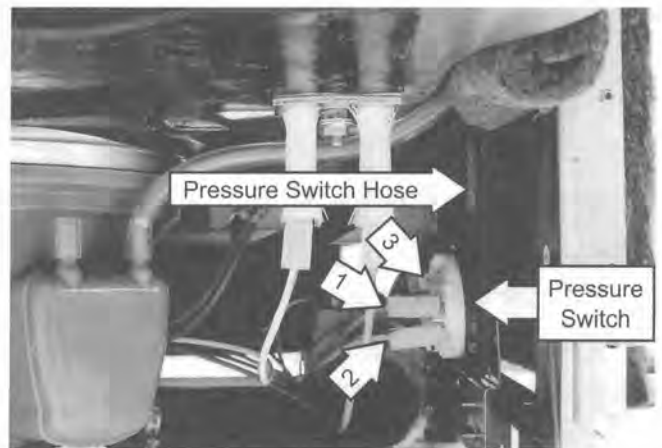

8. Raise the pressure switch to the top of the bracket, rotate the switch ¼ turn and remove.



Note: When installing the pressure switch, ensure the switch is fully seated in the bottom of the bracket.

Drain Pump Assembly

The drain pump assembly is located under the tub at the right rear corner. The drain pump operates on 120 VAC and is energized 90 seconds after the wash pump shuts down to remove any water in the dishwasher sump. The drain pump forces the water out the drain line. A check valve flapper on the drain pump prevents the dirty water from reentering the sump.

The drain pump has an approximate resistance value of 27 Ω .

Operation of the drain pump assembly can be checked by using the service test mode. (See **Service Test Mode**.)

To remove the drain pump:

1. Disconnect power.
2. Open the dishwasher door and remove the bottom rack.
3. Remove the dishwasher from its installation.
4. Lay the dishwasher on its back.
5. Cut off the plastic tie and disconnect the 2 wires from the drain pump.
6. Remove the 2 Phillips-head screws, 7 mm nuts and lockwashers that hold the drain pump to the right side bottom rail.

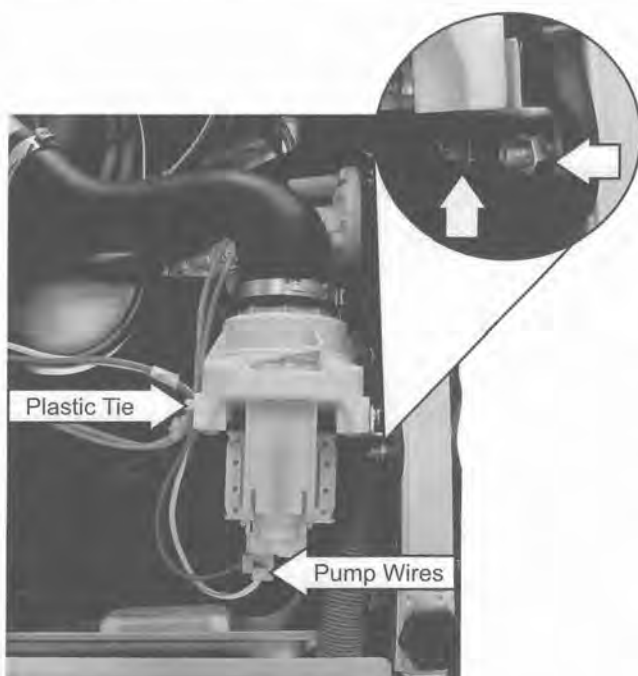

7. Remove the rubber spacer and the 2 Phillips-head screws and lockwashers that attach the pump bracket to the pump.

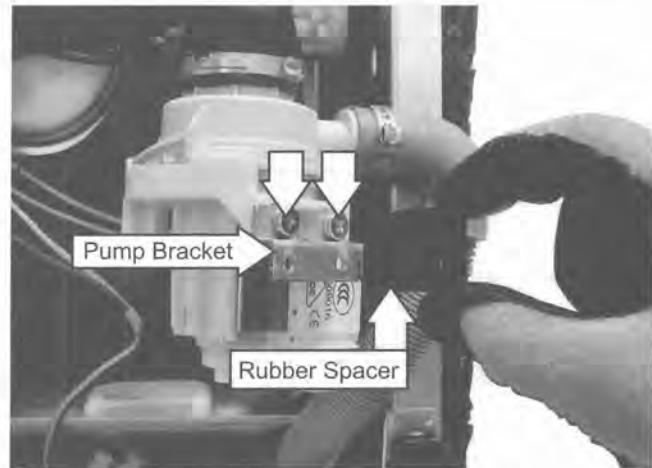

Caution: The clamps are easily damaged during removal and should not be reused.

8. Remove the 2 clamps, sump outlet hose, and the drain hose from the drain pump.

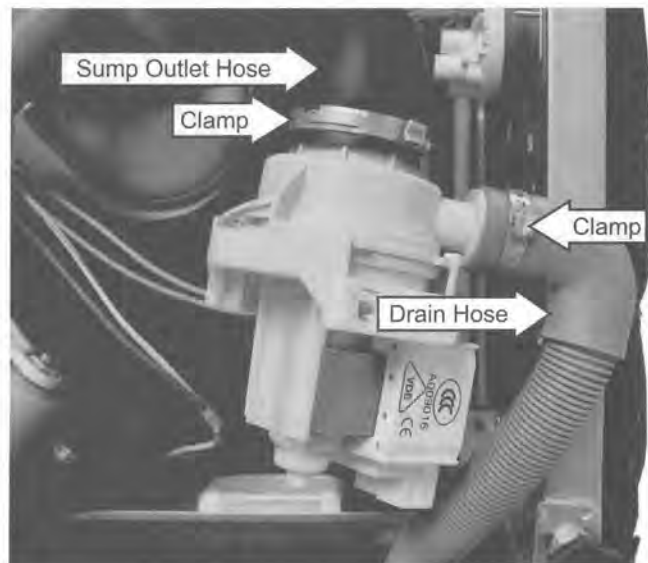

Note: Factory installed hose clamps are non-reusable. When installing a water inlet valve, drain pump assembly, wash pump assembly, or sump assembly, replace the old clamps with new screw-type hose clamps provided with the new part. The screw-type hose clamps are also available separately.

Clamp Part Number	Size
WD01X10322	15/16" to 1-1/2"
WD01X10323	1-3/16" to 1-3/4"
WD01X10324	1/2" to 29/32"

Wash Pump Assembly

The wash pump assembly is located under the tub behind the sump assembly. The motor utilizes a start capacitor rated at 10 μ fd. The motor rotates clockwise (as viewed from the terminal end) and draws approximately 1 amp at 120 VAC.

The wash pump assembly has an approximate resistance value of 17 Ω .

Operation of the wash pump assembly can be checked by using the service test mode. (See **Service Test Mode**.)

To remove the wash pump assembly:

1. Disconnect power.
2. Open the dishwasher door and remove the bottom rack.
3. Remove the dishwasher from its installation.
4. Lay the dishwasher on its back.
5. Disconnect the motor wire harness and the motor ground wire.

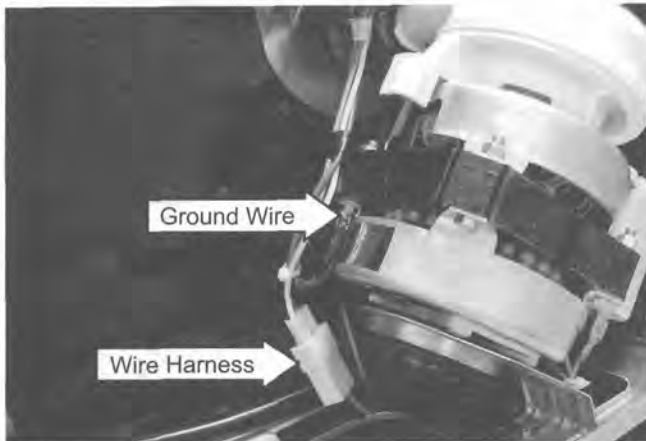

Caution: The clamps are easily damaged during removal and should not be reused.

6. Remove the 3 clamps, pump interconnect hose, and outlet hoses.

Note: Factory installed hose clamps are non-reusable. When installing a water inlet valve, drain pump assembly, wash pump assembly, or sump assembly, replace the old clamps with new screw-type hose clamps provided. The screw-type hose clamps are available separately.

Clamp Part Number	Size
WD01X10322	15/16" to 1-1/2"
WD01X10323	1-3/16" to 1-3/4"
WD01X10324	1/2" to 29/32"

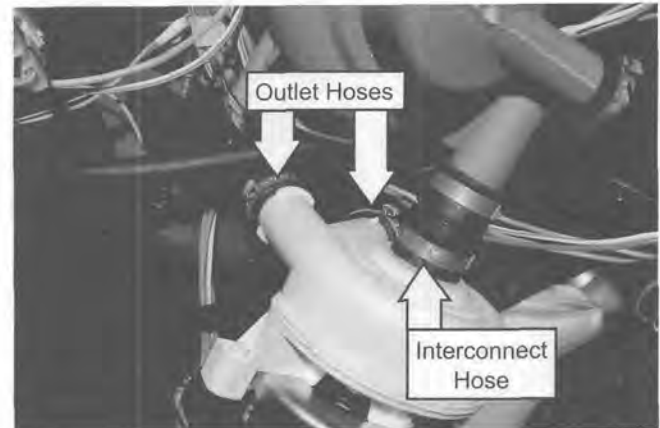

7. Remove the Phillips-head screw that attaches the motor bracket to the back rail.

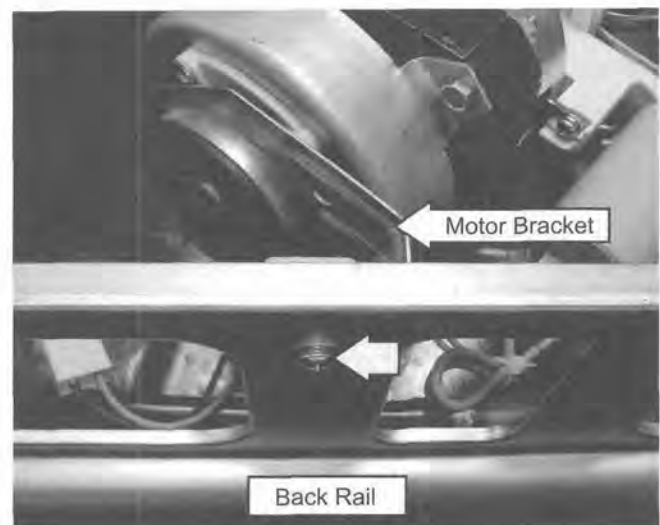

8. Pull the motor bracket off the motor tab.

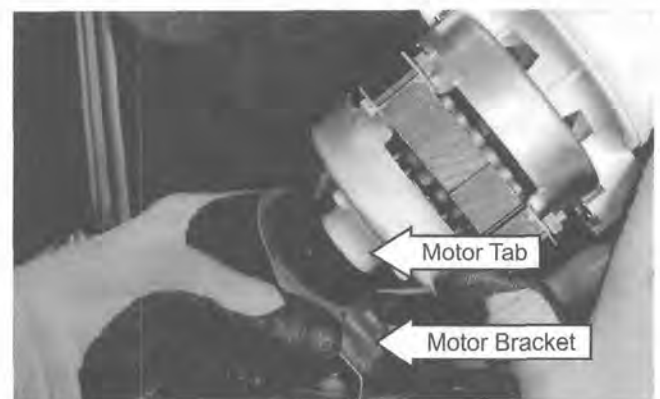

To remove the wash pump capacitor:

Follow steps 1 through 4. (See *To remove the wash pump assembly*.) The capacitor is connected to the motor with 2 wires and held in place with a 13-mm nut.

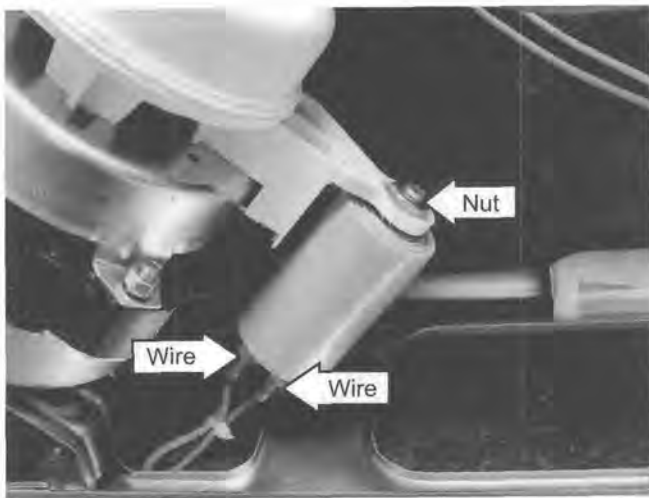

Thermistor

The thermistor is located under the tub and is attached to the left side of the sump with 2 lock tabs. A thermal mastic is applied to the flat side of the thermistor where it makes contact with the underside of the tub.

During the hot wash cycle, the thermistor senses the water temperature and turns the heating element on until the water reaches 128°F.

Note: If the thermistor is not operating, the hot wash cycle will default to a set time for the heating element to cycle.

The thermistor has a negative coefficient. As the temperature at the contact point on the tub increases, the thermistor's resistance decreases. The thermistor has an approximate resistance value of 56.5K Ω at 72°F.

To remove the thermistor:

1. Disconnect power.
2. Open the dishwasher door and remove the bottom rack.
3. Remove the dishwasher from its installation.

4. Lay the dishwasher on its back.
5. Disconnect the thermistor wire harness.

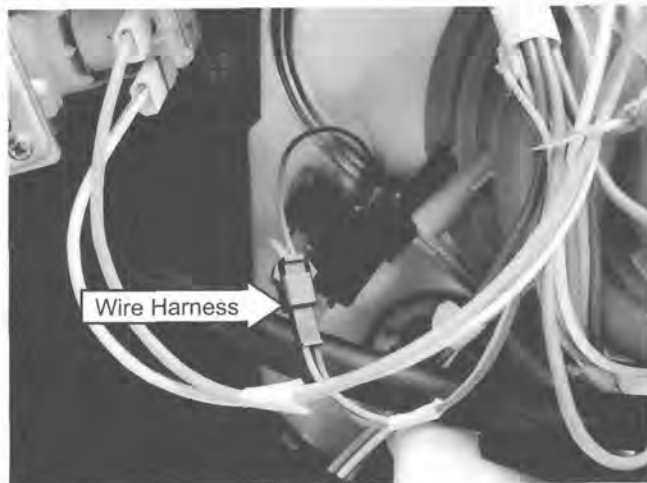

6. Using a small flat-blade screwdriver, lift each of the 2 lock tabs (one on each side) that hold the thermistor to the sump.

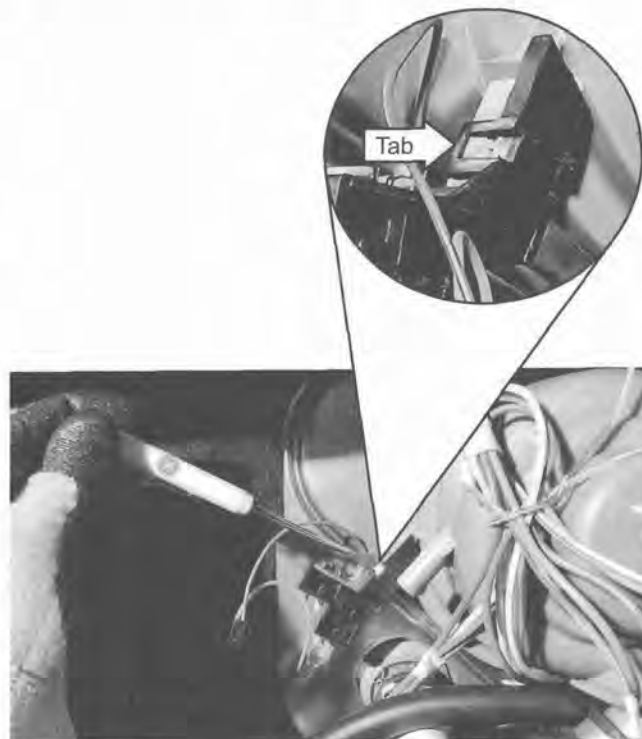

7. Slide the thermistor off the sump.

Note:

- Wear latex gloves to perform this repair.
- Before installing the thermistor, evenly apply white thermal mastic (included in box with part) about 0.10-in. thick over the entire disk.

Sump Assembly

The sump assembly consists of the filter assembly, micro-filter, sump clamping nut, sump gasket, and sump. The filter assembly prevents large particles from reaching the micro-filter and the micro-filter prevents small particles from reaching the sump. The filter assembly rests above the sump and the micro-filter sits above the sump basin. The clamping nut holds the sump gasket and sump to the bottom of the dishwasher. The filter assembly, micro-filter, and sump clamping nut are accessed from inside the dishwasher. The gasket and sump are located under the tub in front of the motor pump assembly.

To remove the sump assembly:

1. Disconnect power.
2. Open the dishwasher door and remove the bottom rack.
3. Remove the dishwasher from its installation.
4. Lay the dishwasher on its back.
5. Disconnect the thermistor wire harness.
6. Remove the pressure switch hose from the sump.

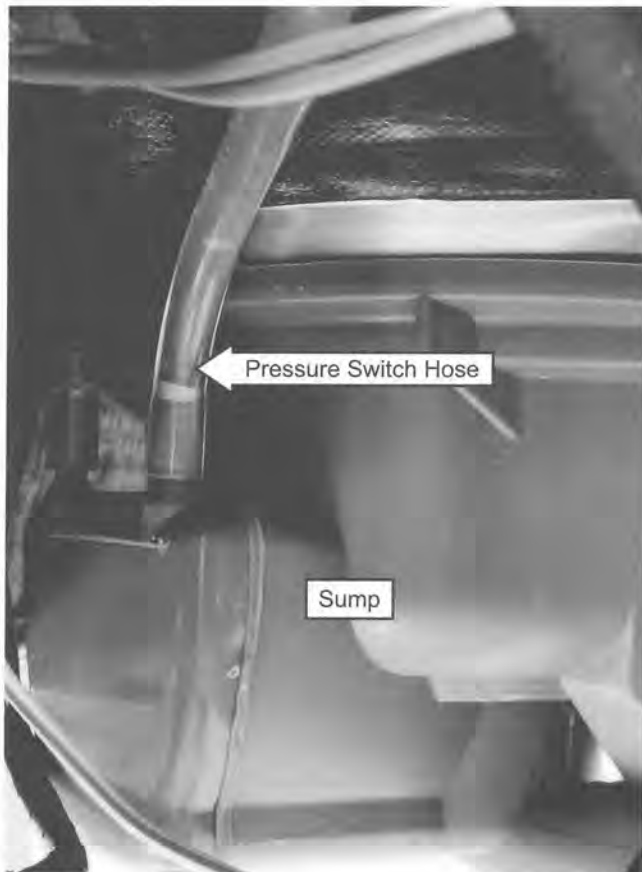

Caution: The clamps are easily damaged during removal and should not be reused.

7. Remove the 2 clamps, sump outlet hose, and interconnect hose from the sump.

Note: Factory installed hose clamps are non-reusable. When installing a water inlet valve, drain pump assembly, wash pump assembly, or sump assembly, replace the old clamps with new screw-type hose clamps provided. The screw-type hose clamps are available separately.

Clamp Part Number	Size
WD01X10322	15/16" to 1 1/2"
WD01X10323	1 3/16" to 1 3/4"
WD01X10324	1/2" to 29/32"

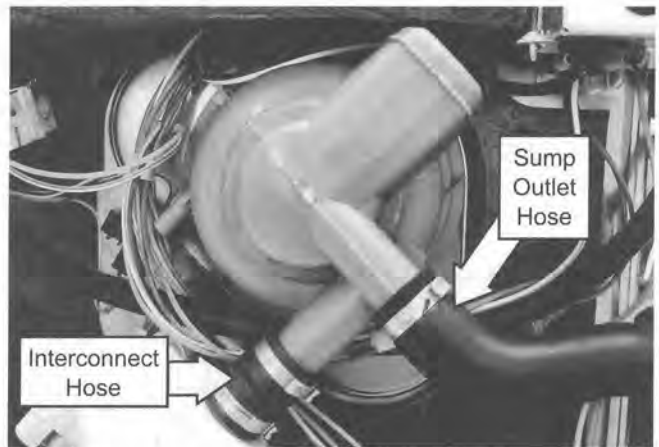

Note: The sump clamping nut turns counterclockwise and may be difficult to remove. It may be helpful to insert a 3/4-in. wide x 4 1/2-in. long piece of wood between the clamping nut tabs to enable you to apply sufficient torque to break the factory seal.

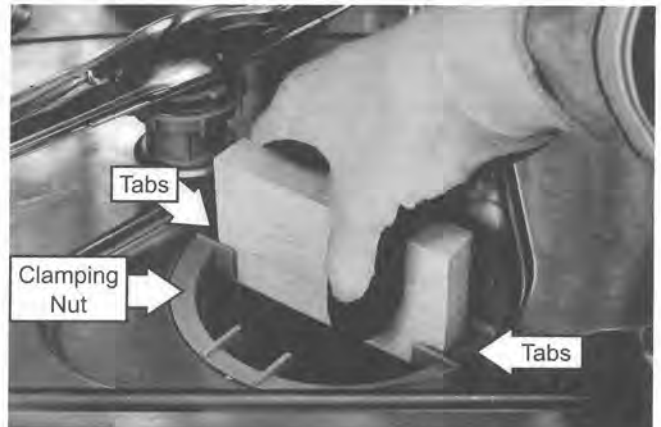

8. Remove the sump clamping nut.
9. Remove the sump gasket (not shown) and sump.

Diagnostics and Service Information

Service Test Mode

This dishwasher is programmed with a service test mode to aid the technician in troubleshooting. Certain components can be independently activated.

To enter the service test mode, the dishwasher must be in the standby mode. Press the Light Wash and Delay Hours keypads simultaneously and hold for 3 seconds.

COMPONENT ACTIVATED	KEYPAD PRESSED	MAXIMUM ACTIVATION TIME
MOTOR PUMP	HOT START	2 MINUTES
DRAIN PUMP	HOT WASH	1 MINUTE
DETERGENT/RINSE MODULE	HEATED DRY	1 MINUTE
WATER VALVE	POTS & PANS	1 MINUTE
HEATING ELEMENT	NORMAL WASH	2 MINUTES

To exit the service test mode, press the START/RESET keypad at any time.

Specifications

Electrical Supply (Under Load)	120VAC \pm 10%
Supply Water Flow Rate	Must fill 1.05 gallons container in 36 seconds
Supply Water Temperature*	120°F to 150°F (49°C to 66°C)
Water Fill	1.05 gallons (4 liters)
Spray Arm Rotation	20 to 60 RPM
Thermistor	56.5K Ω at 72°F
Water Valve	1036 Ω
Dispenser Wax Motor	2.6K Ω
Wash Pump	17 Ω
Drain Pump	27 Ω
Heater	21.2 Ω
Heater Wattage	Wet: 630 watts Dry: 465 watts

*Before starting dishwasher, run the water at the sink faucet until hot.

Troubleshooting

Troubleshooting Chart

	Control Assembly Does Not Work	Detergent/Rinse Module Does Not Work	Drain Pump Does Not Work	Heating Element Does Not Work	Keypad Does Not Work	Wash Pump Does Not Work	No Input Power	Water Inlet Valve Does Not Work	2-Digit Display Does Not Work
Control Assembly	●								
Detergent/Rinse Module		●							
Door Switch Assembly	●				●			●	●
Drain Pump			●						
Heating Element				●					
Keypad					●				
Wash Pump						●			
Pressure Switch								●	
Water Inlet Valve								●	
2-Digit Display									●

Schematics and Wiring Diagrams

Electric Model

WARNING: Disconnect electrical power before servicing.

Caution: Label all wires prior to disconnection. Wiring errors can cause improper and dangerous operation. Verify operation after servicing.

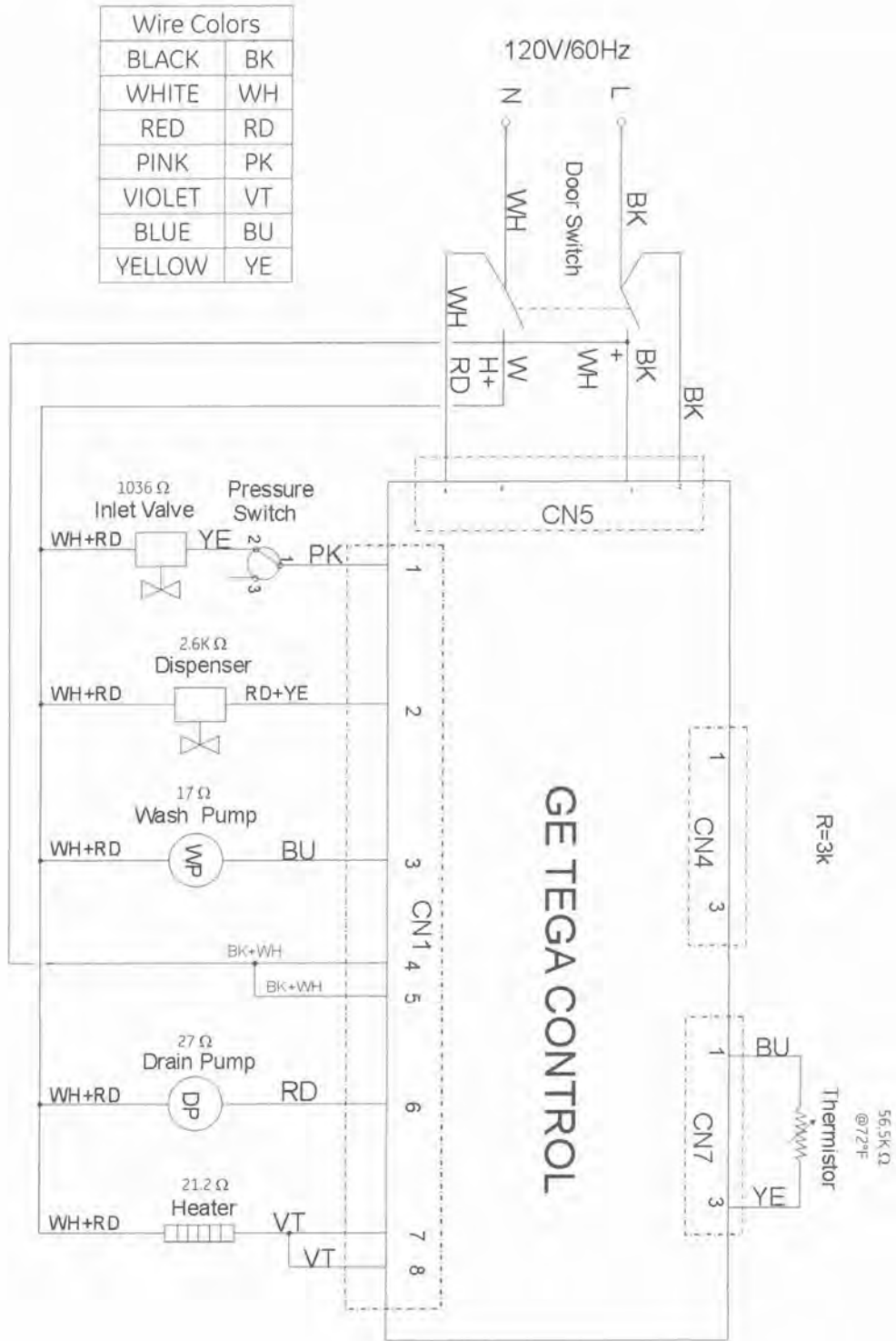

Warranty

GE Dishwasher Warranty.



All warranty service provided by our Factory Service Centers, or an authorized Customer Care[®] technician. To schedule service, on-line, 24 hours a day, visit us at GEAppliances.com, or call 800.GE.CARES (800.432.2737).

Staple your receipt here.
Proof of the original purchase date is needed to obtain service under the warranty.

For The Period Of: GE Will Replace:

One Year

From the date of the original purchase

Any part of the dishwasher which fails due to a defect in materials or workmanship. During this **full one-year warranty**, GE will also provide, **free of charge**, all labor and in-home service to replace the defective part.

What GE Will Not Cover:

- Service trips to your home to teach you how to use the product.
- Improper installation, delivery or maintenance.
- Failure of the product if it is abused, misused, or used for other than the intended purpose or used commercially.
- Replacement of house fuses or resetting of circuit breakers.
- Damage to the product caused by accident, fire, floods or acts of God.
- Incidental or consequential damage caused by possible defects with this appliance.
- Cleaning or servicing of the air gap device in the drain line.
- Damage caused after delivery.

This warranty is extended to the original purchaser and any succeeding owner for products purchased for home use within the USA. Proof of original purchase date is needed to obtain service under the warranty. In Alaska, the warranty excludes the cost of shipping or service calls to your home.

Some states do not allow the exclusion or limitation of incidental or consequential damages. This warranty gives you specific legal rights, and you may also have other rights which vary from state to state. To know what your legal rights are, consult your local or state consumer affairs office or your state's Attorney General.

Warrantor: General Electric Company, Louisville, KY 40225



GE Consumer & Industrial
Appliances
General Electric Company
Louisville, KY 40225
ge.com