



ELECTROLUX HOME PRODUCTS NORTH AMERICA

***SERVICE UPDATE MANUAL
FOR 30" ELECTRIC
FREESTANDING RANGES***

Frigidaire

TAPPAN[®]

W White-Westinghouse

Gibson

Kelvinator 

! ATTENTION !

This service manual is intended for use by persons having electrical and mechanical training and a level of knowledge of these subjects generally considered acceptable in the appliance repair trade. Electrolux Home Products cannot be responsible, nor assume any liability, for injury or damage of any kind arising from the use of this manual.

Table of Contents

SAFE SERVICING PRACTICES.....	3	LEG LEVELERS.....	22
SERVICE TIPS		Bake-N-Warm™ DOUBLE OVEN	23-27
Develop Good Work Habits.....	4	Mini Oven Operation.....	23
Service Tools and Equipment.....	5	Diagnosing Mini Oven Failure	24
CHANGES AND FEATURES OVERVIEW	5	Replacing Mini Oven Element	25
ABBREVIATIONS AND TERMS	5	Replacing Drawer Glide Rails.....	26
MODEL NUMBERING SYSTEM	6	Replacing Drawer Seal and Magnet Latch	26
SERIAL NUMBERING SYSTEM	6	Mini Oven Chassis.....	27
RANGE TECHNICAL DATA.....	7-10	COMPONENT TESTING.....	27-28
Quick Reference Sheet	7	ELECTRONIC OVEN CONTROLS	29-30
Maximum Allowable Surface Temperatures	7	ES 200 CONTROL	30
Removing and Replacing Warmer Drawer	7	ES 300 CONTROL	30
Electric Range Component Resistance Chart.....	8	ES 330 CONTROL	30
EOC Failure / Fault Codes	9	ES 340 CONTROL	30
ESEC System Failure / Fault Codes	10	ES 510 CONTROL	30
Oven Temperature Calibration.....	10	TROUBLESHOOTING ELECTRONIC OVEN	
RANGE INSTALLATION INSTRUCTIONS.....	11 - 14	CONTROLS.....	31-32
Clearances and Dimensions.....	11	EOC Failure / Fault Codes	32
Important Safety Instructions.....	11	ES 510 ELECTRONIC OVEN CONTROL.....	33-35
Tools You Will Need.....	12	Troubleshooting the ES510 EOC	33
Anti Tip Bracket Installation Instructions.....	12	EOC Wire Harness Connections	34
Electrical Connection Requirements	12	ES510 EOC Relay Test Point Matrix	35
Electrical Connection To Range	13	Component Test Point Matrix	35
Power Cord Connections.....	13 - 14	Sales Demo Mode	35
Permanent Wire Connections.....	14	ELECTRONIC SURFACE ELEMENT	
SMOOTH GLASS COOKTOP SERVICING	15-16	CONTROL (ESEC) SYSTEM VERSION 10R	36-38
Removing and Replacing Surface Elements.....	15	How The ESEC System Operates.....	37
Surface Element Terminal Connections	16	Troubleshooting The ESEC System.....	37
WARMER DRAWER	16-19	ESEC Failure / Fault Codes	38
Troubleshooting Warmer Drawer Operation.....	17	SERVICING THE ESEC	
Servicing Warmer Drawer Components	18-19	SYSTEM COMPONENTS	38-43
OVEN DOOR.....	19-21	Potentiometers	38-39
Removing and Replacing Oven Door.....	19-20	Display Boards	40
Replacing Oven Door Hinge.....	20	User Interface Board	41
Replacing Hinge Receptacle	21	Troubleshooting The Power Board.....	41
BODYSIDE MOUNTING	22	Remote Relay Board	42-43

SAFE SERVICING PRACTICES - ALL APPLIANCES -

To avoid personal injury and/or property damage, it is important that Safe Servicing Practices be observed. The following are some limited examples of safe practices:

1. **DO NOT** attempt a product repair if you have any doubts as to your ability to complete it in a safe and satisfactory manner.

2. **Before servicing or moving an appliance:**
 - Remove the power cord from the electrical outlet, trip the circuit breaker to the OFF position, or remove the fuse.
 - Turn off the gas supply.
 - Turn off the water supply.

3. **Never interfere with the proper operation of any safety device.**

4. **USE ONLY REPLACEMENT PARTS CATALOGED FOR THIS APPLIANCE. SUBSTITUTIONS MAY DEFEAT COMPLIANCE WITH SAFETY STANDARDS SET FOR HOME APPLIANCES.**

5. **GROUNDING:** The standard color coding for safety ground wires is GREEN, or GREEN with YELLOW STRIPES. Ground leads are not to be used as current carrying conductors. It is EXTREMELY important that the service technician reestablish all safety grounds prior to completion of service. Failure to do so will create a hazard.

6. **Prior to returning the product to service, ensure that:**
 - All electrical connections are correct and secure
 - All electrical leads are properly dressed and secured away from sharp edges, high-temperature components, and moving parts
 - All non-insulated electrical terminals, connectors, heaters, etc. are adequately spaced away from all metal parts and panels
 - All safety grounds (both internal and external) are correctly and securely connected
 - All panels are properly and securely reassembled

ATTENTION!!!

This service manual is intended for use by persons having electrical and mechanical training and a level of knowledge of these subjects generally considered acceptable in the appliance repair trade. Electrolux Home Products cannot be responsible, nor assume any liability, for injury or damage of any kind arising from the use of this manual.

SERVICE TIPS - DEVELOP GOOD WORK HABITS

Consistently following a standard procedure when servicing appliances will insure that you do not waste time searching for a complex solution to a simple problem. **One of the most common mistakes made by service technicians is failing to verify the incoming power supply to the appliance.**

Many times electronic oven controls and other components are replaced unnecessarily because the incoming power supply was not verified. The technician assumes that the power supply must be good because the top burners or surface elements work. Most electronic controls must have a 120 volt power supply before they will operate. This is usually accomplished by supplying L1 voltage and **neutral or ground** from the household power supply. On most electric ranges if the neutral or ground circuit fails the top surface elements will still operate but the electronic control as well as any other 120 volt components such as the oven lamp, self clean latch motor, and some indicator lamps will not function.

When testing the electrical supply to an electric range the test should be performed at the terminal block where the power cord or house wiring attaches to the range. Verify that there are 240 volts to the two outside terminals on the block and that there is 120 volts from each of the outside terminals to the neutral terminal in the center of the terminal block. You should also check the power supply while the range is operating or “under load”. The power supply may check good with the range sitting idle but fail when the elements are turned on. This can be caused by a weak connection in the customer’s house wiring, or a faulty circuit breaker or fuse.

When servicing a gas range the power supply should be checked at the wall outlet with a plug in circuit tester or volt meter. Make sure that the outlet is properly polarized and grounded. There are many good plug-in circuit/polarity testers available that will perform this test quickly and easily. When testing with a volt meter remember that the narrow slot in the wall outlet is the L1 or voltage side of the circuit and the wide slot is the neutral. The round or “D” shaped hole is the ground circuit. A properly polarized 120 volt wall outlet will have voltage between the L1 (narrow slot) and neutral (wide slot) as well as between L1 and ground (See Fig. 1 below). Do not assume that because the wall outlet has a ground slot that it is grounded. ***Check it out!*** Modern electronic controls must have a correctly polarized and grounded power supply for proper operation.

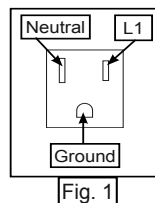

Another common mistake is failure to verify all component part wire harness connections. It is essential that all component connections be checked visually and with the appropriate circuit tester. Many times components are assumed to be faulty because they do not operate when the failure is caused by a loose or miswired connection. New ranges may have loose connections resulting from shipping and handling conditions or improper installation. A good example is if the EOC on a new range can not be programmed it could be due to a faulty temperature sensor probe connection. Most Electronic Oven Controls will not allow programming if there is no input from the probe. Check it out before you replace the EOC.

When the repair has been completed the product should be thoroughly tested to verify that the service performed corrected the problem and that all of the other features and functions of the product are in proper working order. The extra time taken to do this will create consumer confidence in your efficiency and professionalism as well as possibly saving an expensive callback.

SERVICE TOOLS AND EQUIPMENT

In addition to standard hand tools such as wrenches, screwdrivers, pliers, etc; the following instruments are considered to be essential equipment for technicians servicing Electrolux cooking products. Proper testing and diagnostic procedures are not possible without these tools.

- Volt/ohmmeter - Must be capable of voltage measurement from 0 to 500 volts AC and resistance measurements from 0 to 2 meg-ohms. This usually requires a meter that utilizes a 9 volt battery. Either digital or analog meters are acceptable however most technicians find analog meters easier to use.
- Clamp on amp meter - Should be capable of measuring from 0 to 60 amps.
- Temperature Meter - Should be high quality with thermocouple or electronic "K-type" test probe. Capable of temperature readings up to 1000 degrees Fahrenheit.

Additional instruments that a technician will need to have access to at various times include the following:

- Combustible gas leak detection meter.
- U tube manometer or equivalent testing device for measuring LP and Natural gas line pressure on gas ranges. Measurements must be in IWC (inches water column)
- Carbon Monoxide (CO) detection meter capable of measuring from 0-1000 PPM.
- Microwave Leak Detection Meter

CHANGES AND FEATURES OVERVIEW

For 2004/2005 some important new features and design changes have been introduced into our gas and electric freestanding ranges. Below is a list of the most significant changes.

- LARGER OVEN CAPACITY - 5.4 cu. ft. & 5.3 cu. ft.
- FRONT MOUNTED LEVELING FEET FOR GREATER STABILITY
- IMPROVED DOOR HINGE DESIGN FOR EASIER DOOR REMOVAL
- EXPANDED **EOC** and **ESEC** FAULT CODES FOR MORE ACCURATE DIAGNOSIS
- Bake -N-Warm™ Double Oven *
- NEW BODY SIDE DESIGN AND SERVICE PROCEDURE.

*THESE FEATRUES NOT FOUND ON ALL MODELS

ABBREVIATIONS AND TERMS FOUND IN THIS MANUAL

EOC	= ELECTRONIC OVEN CONTROL
RTD	= RESISTANCE TEMPERATURE DEVICE (Temperature Sensor Probe)
GND	= GROUND
LED	= LIGHT EMITTING DIODE
UIB	= USER INTERFACE BOARD
ESEC	= ELECTRONIC SURFACE ELEMENT CONTROL
POT	= POTENTIOMETER
Mini Oven	= Bake -N-Warm™ Double Oven
Mother Board	= Power Board = Surface Element Control Board

Model Numbering System for Free-Standing, Slide-in & Drop-in Ranges

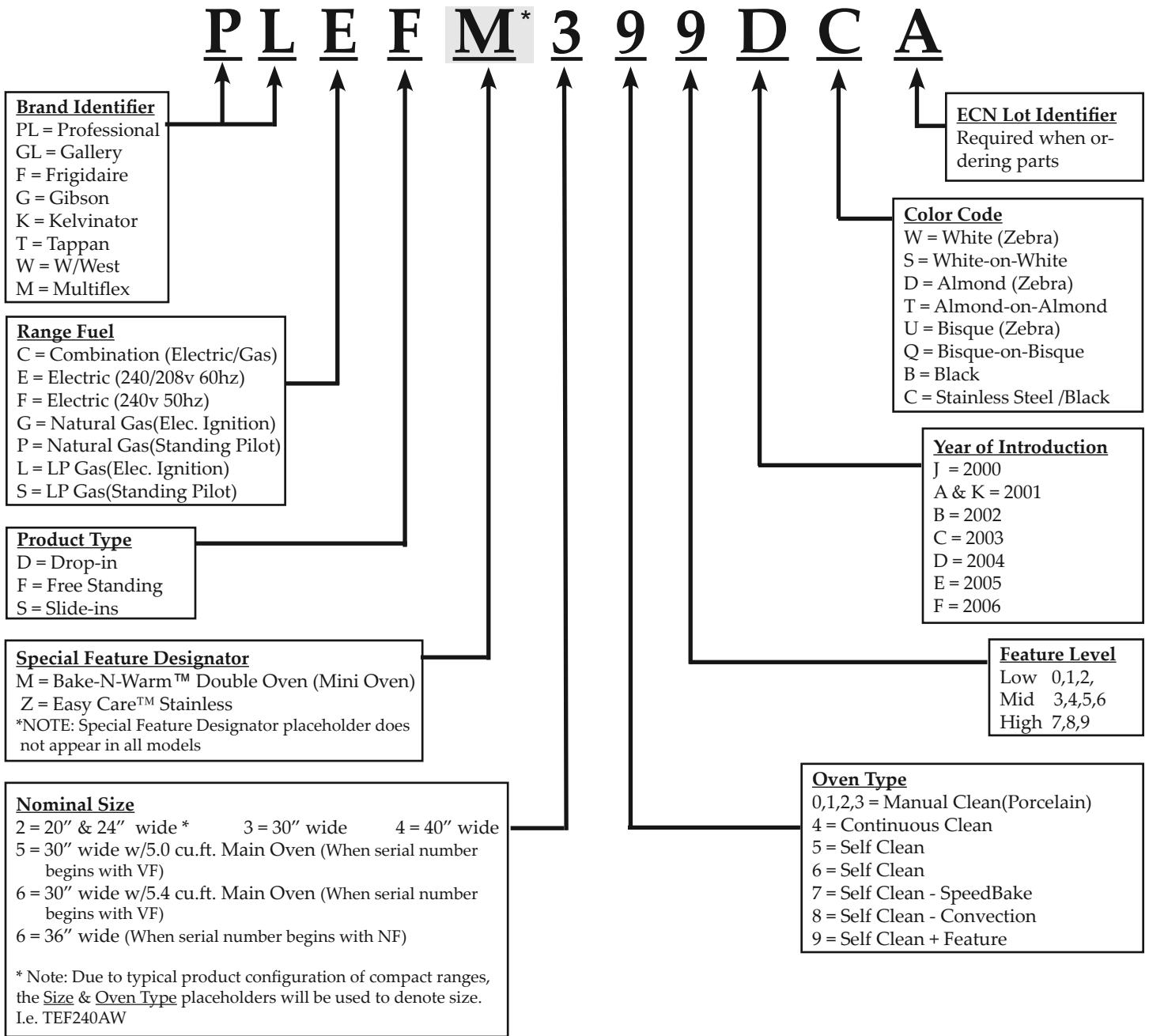

Country Specific Derivatives have a designated letter code placed as first digit of model number.
 Customer Specific Derivatives have a designated letter code following the Product Type digit.

Serial Numbering System

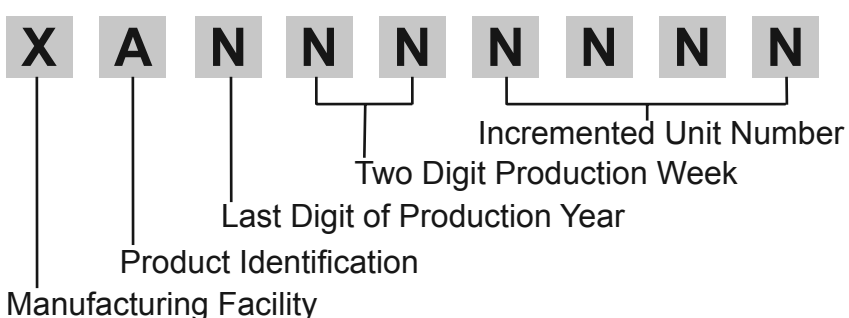

A = Alpha
 N = Numeric
 X = Either Alpha or Numeric

RANGE TECHNICAL DATA

Quick Reference Sheet

Maximum Allowable Surface Temperatures

All gas and electric ranges must comply with U.L. and A.N.S.I. surface temperature limits outlined in the following chart. Note that the testing temperature is different for electric ranges produced *after* 08/26/2003.

SURFACE TEMPERATURE LIMITS
1. Product must be undamaged, correctly assembled and have the correct oven temperature.
2. All skin temperatures are based on a room temperature of 77° F (25° C) and an oven set temperature of 400° F for gas and electric ranges built prior to 08/26/2003. Oven set temperature should be 475° F for electric products built after 8/26/2003.
3. Oven must be cycling at designated test temperature for one hour before test is conducted.
4. Pyrometers, (temperature testers), must be of high quality and properly adjusted.
5. An increase or decrease of 1° F in the room ambient temperature, will allow a 1° F increase or decrease in the maximum allowable surface temperature of the range.

LOCATION	MATERIAL TYPE / FINISH				
	PAINTED	PORCELAIN	GLASS	PLASTIC	METAL
Side Panel	152° F	160° F	—	—	—
Oven Door	152° F	160° F	172° F	182° F	—
Warmer Drawer Front Panel	152° F	160° F	—	—	—
Knobs & Handles	—	—	—	*167° F **182° F	131° F **152° F
Skirt	—	—	—	*182° F	*152° F
Cooktop Lower Console Oven Vent Area	NO TEMPERATURE LIMITS APPLY TO THIS AREA				

* Includes plastic with metal plating not more than 0.005" thick and metal with a plastic covering not less than 0.005" thick.
** Self-Clean Electric Range at Clean Temperature

RTD Temperature / Resistance Chart

The following chart can be used to test the resistance of the oven temperature sensor probe. For accuracy in testing use a high quality thermometer or temperature meter to determine actual oven temperature before reading the

RTD SCALE	
TEMPERATURE °F	RESISTANCE Ω
32 ± 1.9	1000 ± 4.0
75 ± 2.5	1091 ± 5.3
250 ± 4.4	1453 ± 8.9
350 ± 5.4	1654 ± 10.8
450 ± 6.9	1852 ± 13.5
550 ± 8.2	2047 ± 15.8
650 ± 13.6	2237 ± 18.5
900 ± 13.6	2697 ± 24.4

Removing and Replacing Warmer Drawer

To Remove Warmer Drawer:

1. Turn power off before removing the warmer drawer.
2. Open the drawer to the fully opened position.
3. On the right glide you will find a shield attached with a hex-head screw (see figure 1). Using a 1/4" socket and ratchet remove the shield.
4. Locate glide lever on each side of drawer, pull up on the left glide lever and push down on the right glide lever.
5. Pull the drawer away from the range.

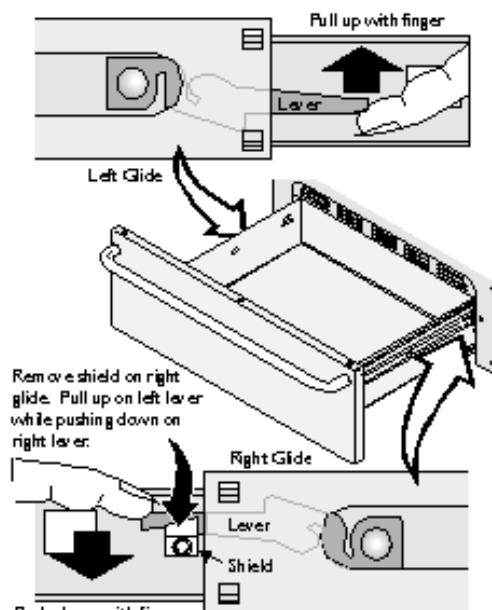
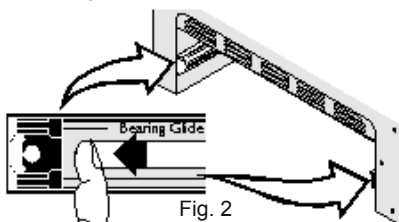

Fig. 1

Warning

Electrical Shock Hazard can occur and result in serious injury or death. Disconnect appliance from electric power before cleaning and servicing the warmer drawer.

To Replace Warmer Drawer:

1. Replace shield on the right glide of the drawer body.
2. **Pull the bearing glides to the front** of the chassis glide (see figure 2).
3. Align the glide on each side of the drawer with the glide slots on the range.
4. Push the drawer into the range until levers "click" (approximately 2"). Pull the drawer open again to seat bearing glides into position. **If you do not hear the levers "click" or the bearing glides do not feel seated remove the drawer and repeat steps 2-4.** This will minimize possible damage to the bearing glides.

RANGE TECHNICAL DATA

Electric Range Component Resistance Chart			
NOTE: Resistance measurements are approximate. Variations due to temperature changes and other factors are normal.			
Component	Voltage Rating	Wattage	Resistance Ω (ohms)
Bake Element	208 / 242	2500	23
Bake Element	208 / 242	2600	22
Bake Element	208 / 242	3500	16
Mini Oven Element	108 / 232	1500	9.6
Warmer Drawer Element	108 / 232	700	20.5
Warmer Drawer Element	108 / 232	450	32
Broil Element	208 / 242	4000	14
Broil Element	208 / 242	3000	19
Convection Element	108 / 232	350	40
8" Coil Surface Element	208 / 242	2100	27.5
6" Coil Surface Element	208 / 242	1250	46
6" Radiant / warmer Element	108 / 232	100	144
6" Radiant Surface Element	208 / 242	1200	48
5" / 7" Expandable Radiant Element	208 / 242	1800 / 1350	Outer / Inner 128 / 42
6" / 9" Expandable Radiant Element	208 / 242	2500 / 1875	Outer / Inner 92 / 31
6" / 9" Expandable Radiant Element	208 / 242	2500 / 1200	Outer / Inner 44 / 48
6" / 9" Expandable Radiant	208 / 242	3000 / 1400	Outer / Inner 35 / 40
8" Radiant Surface Element	208 / 242	2200	26
9" Radiant Surface Element	208 / 242	2500	24
9" / 12" Expandable Radiant Element	208 / 242	2700 / 1700	Outer / Inner 52 / 33
Convection Fan Motor Windings	108 / 232	-	15
Lock Motor Windings	108 / 232	-	2000

RANGE TECHNICAL DATA

EOC Failure / Fault Codes

On freestanding gas and electric ranges manufactured beginning with the serial number date code **VF426** many of the EOC's will have expanded three digit fault codes. These codes may also appear in new replacement EOC's for ranges built prior to this date. Below is a list of possible fault codes that might appear in the EOC display window. The original two digit fault codes appear in the shaded boxes followed by the replacement three digit codes.

For each Fault code there is a listing of the likely failure condition or cause, as well as suggested corrective actions to be taken. Not all fault codes will appear in every model but the fault codes are universal and have the same meaning regardless of the model that is being serviced

Note: Fault codes are not a foolproof system. Never assume that a part has failed based on a displayed fault code. An example would be if the EOC is displaying F30 (open sensor), the failure could be caused by a loose connection or faulty wire harness between the EOC and sensor or the sensor could simply be unplugged.

FAULT CODE	LIKELY FAILURE CONDITION/CAUSE	SUGGESTED CORRECTIVE ACTION
F1	<ul style="list-style-type: none"> F10 Runaway Temperature. F11 Shorted Keypad. F12 Bad Micro Identification. F13 Bad EEPROM Identification/Checksum error. F14 Display tail missing/not connected 	<ol style="list-style-type: none"> 1. (F10 only) Check RTD Sensor Probe & replace if necessary. If oven is overheating, disconnect power. If oven continues to overheat when the power is reapplied, replace EOC. Severe overheating may require the entire oven to be replaced should damage be extensive. 2. (F11, 12 & 13) Disconnect power, wait 30 seconds and reapply power. If fault returns upon power-up, replace EOC. 3. (F14 only) Re-seat the P12 ribbon connector tail. If fault returns replace EOC (first action); Touch Panel (second action)
	<ul style="list-style-type: none"> F20 Communication failure between EOC and ESEC system. F26 Communication failure with mini oven control. 	<ol style="list-style-type: none"> 1. Test harness/connections P4 (EOC) & P11 (Surface element control board). 2. If harness checks O.K. failure can be caused by faulty UIB, surface element control board, or EOC. <p>Check harness and connectors from the EOC to mini oven control board. Check for 15vdc to mini oven control (red & gray wires). If harness and voltage are good replace mini oven control. If fault returns replace EOC.</p>
F3	<ul style="list-style-type: none"> F30 Open probe connection. F31 Shorted Probe connection 	<ol style="list-style-type: none"> 1. (F30 or F31) Check resistance at room temperature & compare to RTD Sensor resistance chart. If resistance does not match the RTD chart replace RTD Sensor Probe. Check Sensor wiring harness between EOC & Sensor Probe connector. 2. (F30 or F31) Check resistance at room temperature, if less than 500 ohms, replace RTD Sensor Probe. Check for shorted Sensor Probe harness between EOC & Probe connector.
	<ul style="list-style-type: none"> F40 Cooktop Lockout error. F41 	<ol style="list-style-type: none"> 1. (F40 or F41) Check the wiring. 2. (F40 or F41) Replace the Cooktop Lockout Control Board. 3. (F40 or F41) Replace EOC.
F9	<ul style="list-style-type: none"> F90 Maximum oven door unlock time exceeded. F91 Maximum oven door unlock attempts exceeded. F92 Maximum oven door open time exceeded. F93 Maximum oven door lock time exceeded. F94 Maximum oven door lock attempts exceeded. 	<ol style="list-style-type: none"> 1. (F90, 91, 92, 93 & 94) Check the wiring between EOC & Lock Motor Micro Switch. 2. (F90, 91, 92, 93 & 94) Replace the Motor Door Latch assembly if necessary. 3. (F90, 91, 92, 93 & 94) Check for binding of the Latch Cam, Lock Motor Rod & Lock Motor Cam. 4. (F90, 91, 92, 93 & 94) Check to see if Lock Motor Coil is open. If open, replace Lock Motor Assembly. 5. (F90, 91, 92, 93 & 94) Lock Motor continuously runs - if Micro Switch is open, replace Lock Motor Assembly. 6. (F92, 93 & 94) Check oven door Light Switch - if open, replace Switch. 7. If all situations above do not solve problem, replace EOC.

RANGE TECHNICAL DATA

ESEC System Failure / Fault Codes

Displayed Fault Code	Description	Suggested Corrective Action
F5 A0	Bad EEPROM checksum.	1. Reset power supply to range. 2. Replace Power Board.
F5 00	Communication break between EOC and UIB.	1. Reset power supply to range. 2. Test ESEC wiring harness. Replace if defective 3. Replace UIB 4. Replace EOC
F5 01	Communication break between Power board & UIB	1. Reset power supply to range. 2. Test ESEC wiring harness. Replace if defective 3. Replace UIB. 4. Replace Power Board
F5 02	UIB not communicating.	1. Defective ESEC harness. Reseat connectors. Test harness and replace if defective. 2. Defective UIB. Replace UIB 3. Defective Power Board. Replace Power Board
F5 F0	Watchdog timer timed out - Power Board.	1. Reset power supply to range. 2. Replace Power Board.
F5 FF	Watchdog timer timed out - UIB.	1. Reset power supply to range. 2. Replace UIB.
F7 10 F7 20 F7 30 F7 40	Potentiometer LF is open. Potentiometer LR is open. Potentiometer RR is open. Potentiometer RF is open.	1. Defective potentiometer. Test and replace if defective. 2. Replace UIB.
F7 11 F7 21 F7 31 F7 41	Potentiometer LF is shorted. Potentiometer LR is shorted. Potentiometer RR is shorted. Potentiometer RF is shorted.	1. Defective potentiometer. Test and replace if defective. 2. Replace UIB. 3. Check for moisture contamination in potentiometer.
F7 12 F7 22 F7 32 F7 42	Potentiometer for LF is wrong value. Potentiometer for LR is wrong value. Potentiometer for RR is wrong value. Potentiometer for RF is wrong value.	1. Wrong value potentiometer installed. Verify correct part . 2. Defective potentiometer. Test and replace if defective. 3. Check for moisture contamination in potentiometer. 4. Replace UIB.

Oven Temperature Calibration

To test oven temperature set the electronic oven control for normal baking at 350°F. After the oven has completed the preheat cycle obtain an average oven temperature after a minimum of 5 cycles. Press **CANCEL** or **CLEAR** to end bake mode. If necessary calibrate the oven temperature. Information on adjusting the oven temperature can be found in the owners manual.

Note: Changing calibration affects all Baking modes. The adjustments made will not change the self-cleaning temperature.

30" ELECTRIC RANGE INSTALLATION INSTRUCTIONS

(For 3 or 4 Wire, 60 Hz. Systems)

INSTALLATION AND SERVICE MUST BE PERFORMED BY A QUALIFIED INSTALLER. IMPORTANT: SAVE FOR LOCAL ELECTRICAL INSPECTOR'S USE. READ AND SAVE THESE INSTRUCTIONS FOR FUTURE REFERENCE.

Clearances and Dimensions

1. **Provide adequate clearances** between the range and adjacent combustible surfaces.
2. **Location—Check location where the range will be installed.** Check for proper electrical supply, and the stability of the floor.
3. **Dimensions that are shown must be used.** Given dimensions provide minimum clearance. Contact surface must be solid and level.

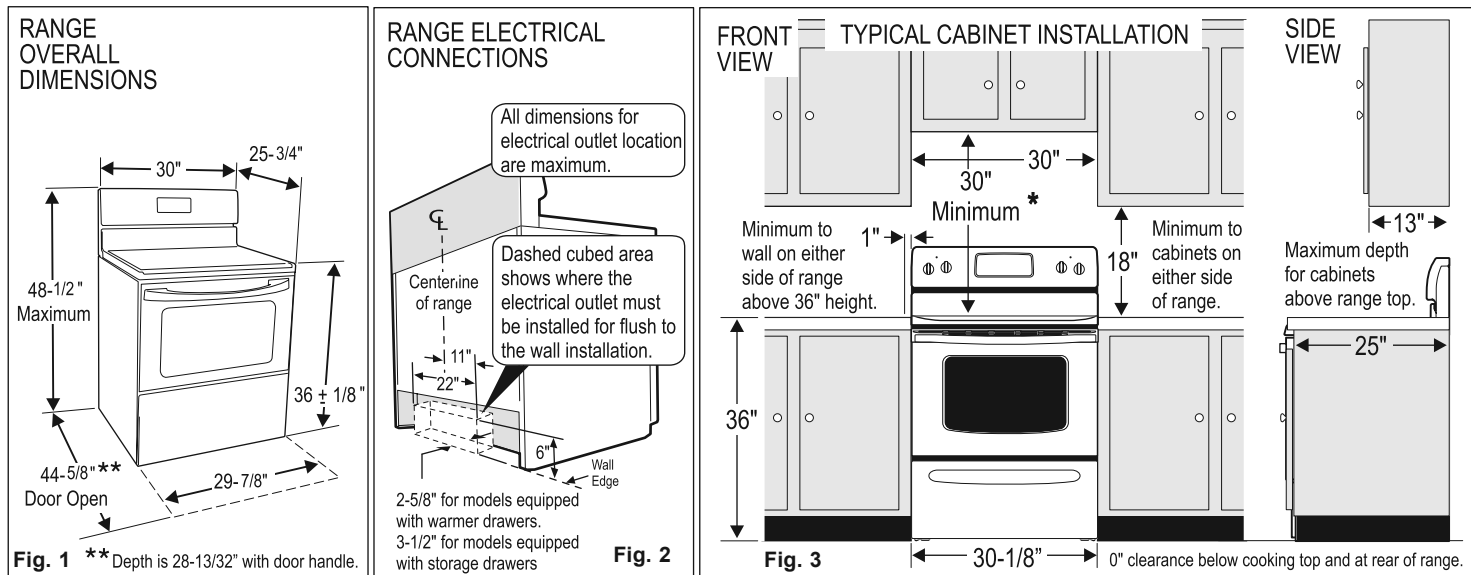

*30" MINIMUM CLEARANCE BETWEEN THE TOP OF THE COOKING SURFACE AND THE BOTTOM OF AN UNPROTECTED WOOD OR METAL CABINET; OR 24" MINIMUM WHEN BOTTOM OF WOOD OR METAL CABINET IS PROTECTED BY NOT LESS THAN 1/4" FLAME RETARDANT MILLBOARD COVERED WITH NOT LESS THAN NO. 28 MSG SHEET STEEL, 0.015" STAINLESS STEEL, 0.024" ALUMINUM OR 0.020" COPPER. 0" CLEARANCE IS THE MINIMUM FOR THE REAR OF THE RANGE. FOLLOW ALL DIMENSION REQUIREMENTS PROVIDED ABOVE TO PREVENT PROPERTY DAMAGE, POTENTIAL FIRE HAZARD, AND INCORRECT COUNTERTOP AND CABINET CUTS.

TO ELIMINATE THE RISK OF BURNS OR FIRE BY REACHING OVER HEATED SURFACE UNITS, CABINET STORAGE SPACE LOCATED ABOVE THE SURFACE UNITS SHOULD BE AVOIDED. IF CABINET STORAGE IS TO BE PROVIDED, THE RISK CAN BE REDUCED BY INSTALLING A RANGE HOOD THAT PROJECTS HORIZONTALLY A MINIMUM OF 5" BEYOND THE BOTTOM OF THE CABINETS.

IMPORTANT SAFETY INSTRUCTIONS

⚠ WARNING If the information in this manual is not followed exactly, a fire or electrical shock may result causing property damage, personal injury or death.

Important Notes to the Installer

- Read all instructions contained in these installation instructions before installing range.
- Remove all packing material from the oven compartments before connecting the gas & electrical supply to the range.
- Observe all governing codes and ordinances.
- Be sure to leave these instructions with the consumer.

Important Note to the Consumer

Keep these instructions with your owner's guide for future reference.

- As when using any appliance generating heat, there are certain safety precautions you should follow. These are listed in the *Use & Care Manual*, read it carefully.
- Be sure your range is installed and grounded properly by a qualified installer or service technician.
- Make sure the wall coverings around the range can withstand the heat generated by the range.
- To eliminate the need to reach over the surface elements, cabinet storage space above the elements should be avoided.



30" ELECTRIC RANGE INSTALLATION INSTRUCTIONS

(For 3 or 4 Wire, 60 Hz. Systems)

BEFORE STARTING

Tools You Will Need

For leveling legs and Anti-Tip Bracket:

- Adjustable wrench or channel lock pliers
- 5/16" Nutdriver or Flat Head Screwdriver
- Electric Drill & 1/8" Diameter Drill Bit (Masonry Drill Bit if installing in concrete)

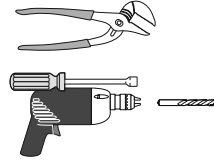

For electrical supply connection:

- 1/4" & 3/8" Socket driver or Nutdriver

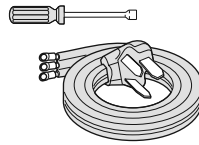

Additional Materials You Will Need:

- Power Supply Cord or
- Copper Electrical Wiring & Metal Conduit (for hard wiring)

NORMAL INSTALLATION STEPS

1. ANTI-TIP BRACKET INSTALLATION INSTRUCTIONS - IMPORTANT SAFETY WARNING

To reduce the risk of tipping of the range, the range must be secured to the floor by properly installed Anti-Tip Bracket and screws packed with the range. Failure to install the anti-tip bracket will allow the range to tip over if excessive weight is placed on an open door or if a child climbs upon it. Serious injury might result from spilled hot liquids or from the range itself.

If range is ever moved to a different location, the Anti-Tip Bracket must also be moved and installed with the range.

Instructions are provided for installation in wood or cement fastened to either the floor or wall. When installed to the wall, make sure that screws completely penetrate dry wall and are secured in wood or metal. When fastening to the floor or wall, be sure that screws do not penetrate electrical wiring or plumbing.

1a. Locate the Bracket using the Template - (Bracket may be located on either the left or right side of the range. Use

the information below to locate the bracket if template is not available).

Mark the floor or wall where left or right side of the range will be located. If rear of range is against the wall or no further than 1-1/4" from wall

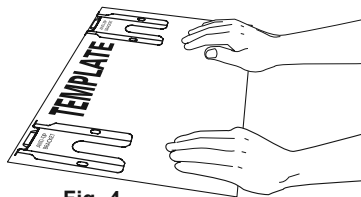

Fig. 4

when installed, you may use the wall or floor mount method. If molding is installed and does not allow the bracket to fit flush against the wall, remove molding or mount bracket to the floor. For wall mount, locate the bracket by placing the back edge of the template against the rear wall and the side edge of template on the mark made referencing the side of the range (See Fig. 4). Place bracket on top of template and mark location of the screw holes in wall. If rear of range is further than 1-1/4" from the wall when installed, attach bracket to the floor. For floor mount, locate the bracket by placing back edge of the template where the rear of the range will be located. Mark the location of the screw holes, shown in template.

1b. Drill Pilot Holes & Fasten Bracket - Drill a 1/8" pilot hole where screws are to be located. If bracket is to be mounted

to the wall, drill pilot hole at an approximate 20° downward angle (See Fig. 5).

If bracket is to be mounted to masonry or ceramic floors, drill a 5/32" pilot hole 1-3/4" deep. The screws provided may be used in wood or concrete material. Use a 5/16" nut-driver or flat head screwdriver to secure the bracket in place (See Fig. 6).

1c. Level and Position Range - Level range by adjusting the (4) leveling legs with a wrench. NOTE: A minimum clearance of 1/8" is required between the bottom of the range and the leveling leg to allow room for the bracket. Use a spirit level to check your adjustments. Slide range back into position (See Fig. 7). Visually check that rear leveling leg is inserted into and fully secured by the Anti-Tip Bracket by removing lower panel or storage drawer. For models with a Warmer Drawer or broiler compartment, grasp the top rear edge of the range and carefully attempt to tilt it forward.

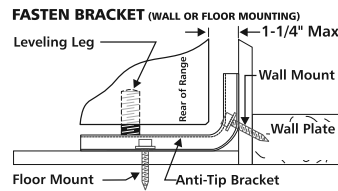

Fig. 5

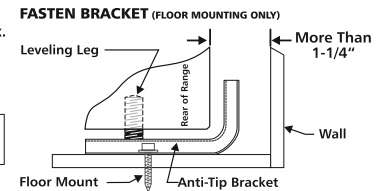

Fig. 6

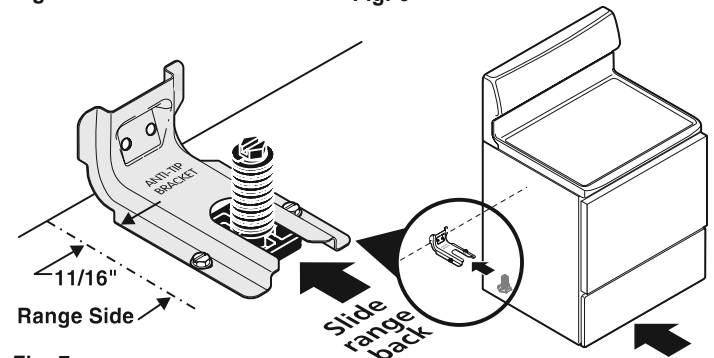

Fig. 7

2. ELECTRICAL CONNECTION REQUIREMENTS - This appliance must be properly installed and grounded by a qualified technician in accordance with the National Electrical Code ANSI/NFPA No. 70 -- latest edition -- and Local Electrical Code requirements.

This appliance may be connected by means of "Permanent Wiring" or "Power Supply Cord Kit."

When installing Permanent Wiring, do not leave excess wire in range compartment. Excess wire in the range compartment may not allow the Rear Access Cover to be replaced properly and could create a potential electrical hazard if wires become pinched. Connect only as instructed under "**Permanent Wire Connections**" in Step 4c. When using flexible conduit or range cable use flex connector or range cable strain relief (Fig. 11).

2a. Models with Factory Connected Power Supply Cord. NOTE: Some models may have a factory installed three (3) conductor Power Supply Cord.

Mobile home installations, new branch circuit installations (1996NEC) or areas where Local Codes do not permit grounding through neutral require a four (4) conductor power supply cord kit rated at 125/250 volts minimum and marked for use with ranges.

30" ELECTRIC RANGE INSTALLATION INSTRUCTIONS

(For 3 or 4 Wire, 60 Hz. Systems)

See Range Connection Opening Size Chart (Figs. 9 & 10) for cord kit ampere rating information. Terminals on end of wires must be either closed loop or open-end spade lugs with upturned ends.

2b. MODELS REQUIRING POWER SUPPLY CORD KIT.

RISK OF FIRE OR ELECTRICAL SHOCK MAY OCCUR IF AN INCORRECT SIZE RANGE CORD KIT IS USED, THE INSTALLATION INSTRUCTIONS ARE NOT FOLLOWED OR STRAIN RELIEF BRACKET IS DISCARDED.

This appliance may be connected by means of a power supply cord. Only a power supply cord kit rated at 125/250 volts minimum, and marked for use with ranges shall be used. See Fig. 10 for cord kit ampere rating information. Cord must have either three (3) or four (4) conductors (See Fig. 8). Terminals on end of wires must be either closed loop or open-end spade lugs with upturned ends. Cord must have strain relief properly installed. See Steps 4a. for 4-Wire or 4b. for 3-Wire connections.

3. ELECTRICAL CONNECTION TO RANGE.

The Rear Access Cover must be removed (Fig 9). To remove, loosen center screw (one screw) and remove cover. The terminal block will then be accessible.

3 & 4 - Wire electrical wall Receptacle types &



Required for new and remodeled installations

4 Wire Wall Receptacle (14-50R)

Fig. 8



Allowed for existing installations

3 Wire Wall Receptacle (10-50R)

NOTE: Range is shipped from factory with 1-3/8" dia. hole as shown. To use either 7/8" dia. hole or 1-1/8" dia. knockouts refer to Fig. 9.

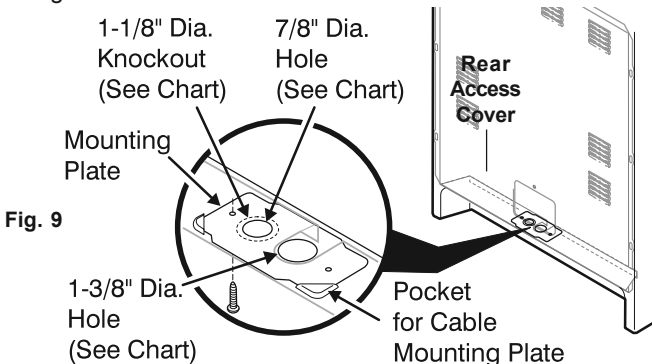

Fig. 9

Fig. 10

Range Connection Opening Size Chart				
Supply Cord Kit ampere rating information. See serial plate on range for kilowatt rating data.				
See Serial Plate on Range for KW Rating		Cord Kit Ampere Rating	Diameter (inches) of Range connection Opening	
120/240 Volts	120/208 Volts		Cord Kit	Permanent Wiring
8.8-16.5 KW	7.9-12.5 KW	40/50 Amp 50 Amp	1-3/8 in.	1-1/8 in.
16.6-22.5 KW	12.6-18.5 KW		1-3/8 in.	1-3/8 in.

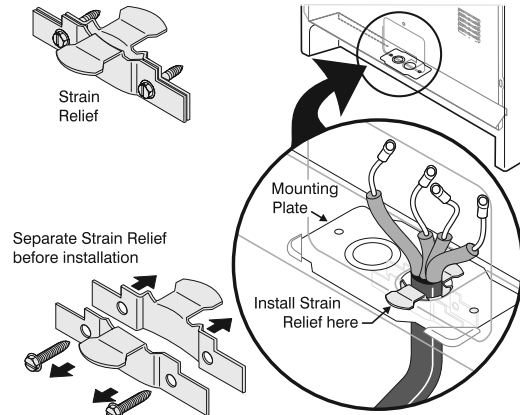

Fig. 11

4A. POWER CORD CONNECTIONS

(4-Wire Connection Instructions - Refer to Fig.12)

Before wiring the range review the suggested power source location drawing in Fig. 3. If connecting to a 4-Wire electrical system (new branch-circuit or mobile home requires 4-Wire connection):

- Follow the manufacturer's installation instructions supplied with the strain relief and install (Also see Figs. 9, 10 & 11).
- Insert the end connectors for Line 1, Line 2 and Neutral and tighten securely to the terminal block. **IMPORTANT NOTE:** DO NOT LOOSEN the factory installed nut connections which secure the range wiring to the terminal block. Electrical failure or loss of electrical connection may occur if these 3 nuts are loosened or removed.
- You must disconnect the ground strap.** Remove the factory installed ground screw & plate to release the copper ground strap from the frame of the appliance. Cut and discard the copper ground strap & plate. KEEP the ground screw.
- Connect the ground wire (Green) lead with the eyelet to the frame of the appliance with the ground screw using the same hole in the frame where the ground screw was originally installed (See Fig. 12).
- Make sure all screws are tightened securely and replace the rear access cover (See Fig. 9).

4-Wire Connection

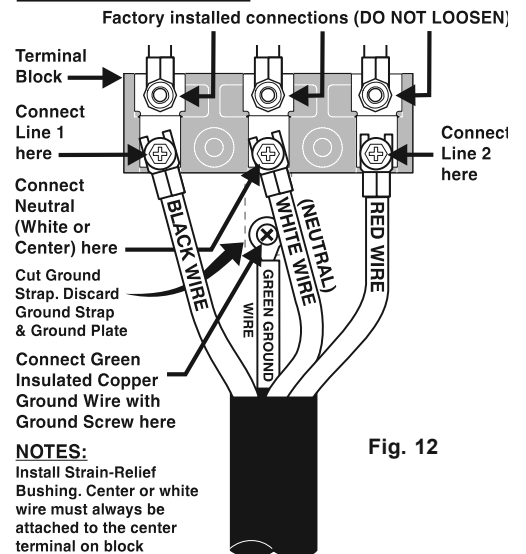

Fig. 12

NOTES:
Install Strain-Relief Bushing. Center or white wire must always be attached to the center terminal on block

30" ELECTRIC RANGE INSTALLATION INSTRUCTIONS

(For 3 or 4 Wire, 60 Hz. Systems)

4B. POWER CORD CONNECTIONS

(3-Wire Connection Instructions . For existing installations ONLY - Refer to Fig. 13).

1. Follow the manufacturer's installation instructions supplied with the strain relief and install (Also see Figs. 9, 10 & 11).
2. Insert the end connectors for Line 1, Line 2 and Neutral and tighten securely to the terminal block (See Fig. 13).
IMPORTANT NOTE: DO NOT LOOSEN the factory installed nut connections which secure the range wiring to the terminal block. Electrical failure or loss of electrical connection may occur if these 3 nuts are loosened or removed.
3. Make sure all connections are tightened securely and replace the rear access cover (See Fig. 9).

Grounding Instructions (3-Wire Connections only): A ground strap is installed on this range which connects the center terminal of the terminal block (Neutral) to the range chassis. The ground strap is connected to the range by the center, lowest screw (See Fig. 13). The ground strap must not be removed unless National, State or Local Codes do not permit use of a ground strap.

NOTE: If the ground strap is removed for any reason, a separate ground wire must be connected to the separate ground screw attached to the range chassis and to an adequate ground source.

4c. 3 & 4-WIRE PERMANENT WIRE CONNECTIONS.

3 - Wire Permanent Connection - follow Steps 1,2 & 5 below.

4 - Wire Permanent Connection - follow Steps 1 thru 5 below.

Before wiring the range, review the suggested power source location drawings in Fig. 3. If connecting to a 4-Wire electrical system (new branch-circuit or mobile home requires 4-Wire connection):

1. **(3 & 4 - Wire Permanent Connections)** Follow the manufacturer's installation instructions supplied with the strain relief and install.
2. **(3 & 4 - Wire Permanent Connections)** Strip insulation away from the ends of the permanent wiring for Line 1, Line 2, Neutral (also strip ground wire on 4-Wire Connections). Tighten all 3 wire leads to the terminal block (Follow wire locations shown in Fig. 14).
IMPORTANT NOTE: DO NOT LOOSEN the factory installed nut connections which secure the range wiring to the terminal block. Electrical failure or loss of electrical connection may occur if these 3 nuts are loosened or removed. **NOTE: For 3-Wire Permanent Connections skip Steps 3 & 4 and continue with Step 5.**
3. **(4-Wire Permanent Connection ONLY)** Disconnect the ground strap. Remove the factory installed ground screw & plate to release the factory installed copper ground strap from frame of the appliance. Cut and discard the copper strap from the terminal block. KEEP the ground screw, ground plate and go to Step 4.
4. **(4-Wire Permanent Connection ONLY)** Connect the ground wire lead (Green) to the frame of the appliance using the ground screw & plate as shown in Fig. 15. Be sure to install using the same hole in the frame where the ground screw was originally installed.
5. **(3 & 4 - Wire Permanent Connections)** Make sure all connections are tightened securely and replace the rear access cover (See Fig. 9).

NOTE: Non-terminated field wire compression connections must be set at approximately 90in./lbs.

5. CAREFULLY SLIDE RANGE INTO FINAL LOCATION.

Be sure to provide all the adequate clearances and dimensions shown in Figs. 1, 2 & 3 before moving range into final location.

Carefully slide range into final position while inserting rear leveling leg into and FULLY ENGAGING THE ANTI-TIP BRACKET (See Fig. 7). Make sure the power cord folds into the remaining open floor area

3-Wire Connection

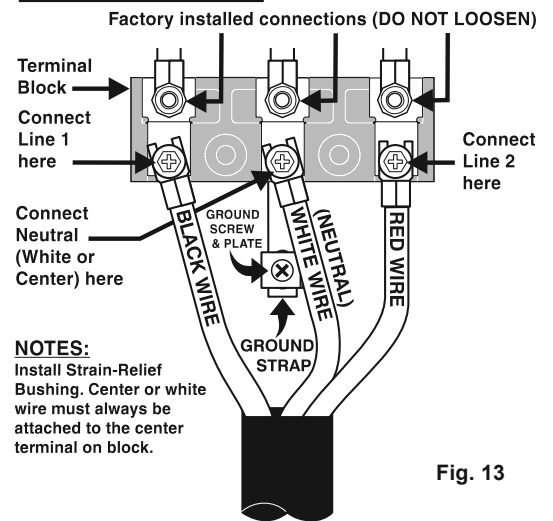

Fig. 13

FOR 3 & 4-Wire Permanent Connections

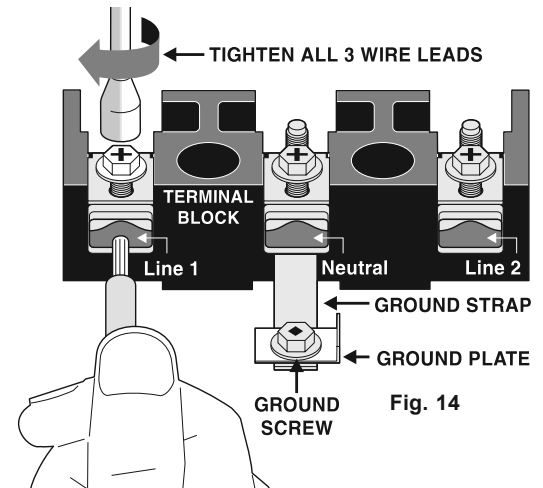

Fig. 14

4-Wire Permanent Connection ONLY

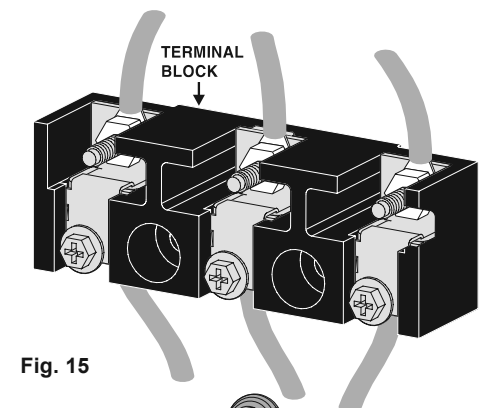
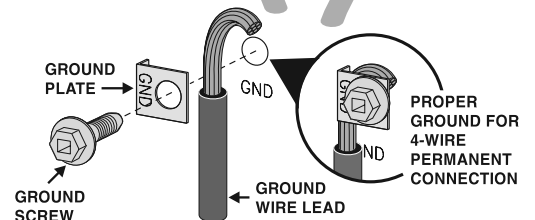

Fig. 15



SMOOTH GLASS COOKTOP SERVICING

The procedure for servicing the smooth glass cooktop and surface elements is the same as in previous models. The front of the cooktop can be lifted by removing the two screws that secure it to the range chassis.

With the cooktop in the raised position the surface heating elements, warmer zone element and their wiring connections are accessible. The top can be held open by using a wood or plastic prop rod approximately 28 inches long. In the photos below a 1" diameter wooden dowel is used. Use caution not to damage the oven insulation blanket when placing the prop rod.

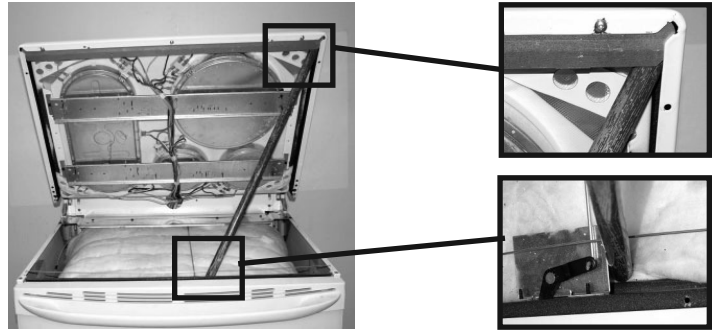

Removing and Replacing Surface Elements

1. Before removing the element be sure to note the locations of the element mounting clips in the support channel slot. The replacement element must be installed in the same position.

2. Carefully remove the wires from the element. Take note of the **terminal identification** on the element terminal block for each wire connection.

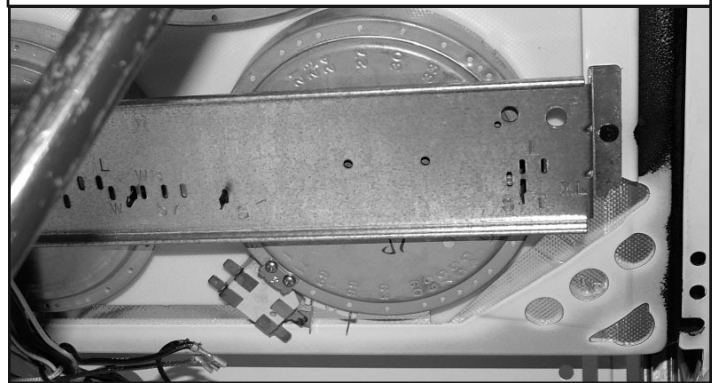
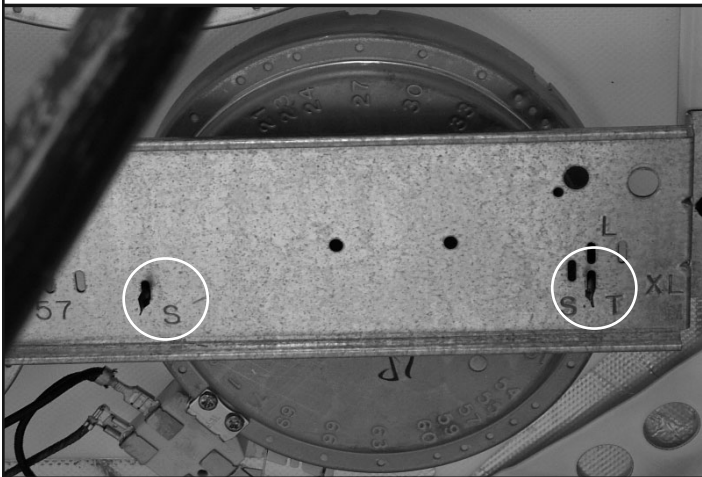

4. Remove the mounting screw that secures the element support channel to the cooktop.

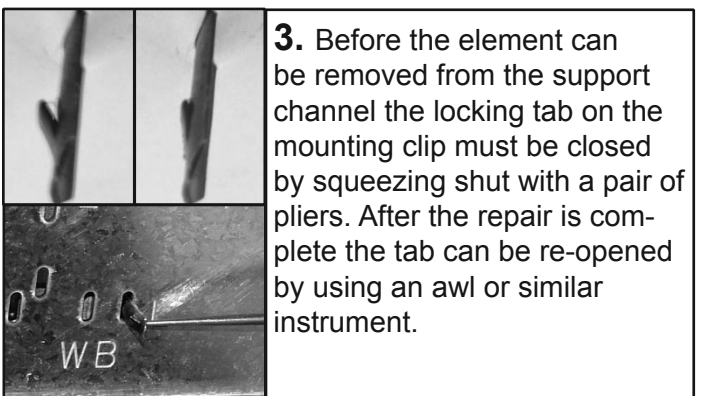

3. Before the element can be removed from the support channel the locking tab on the mounting clip must be closed by squeezing shut with a pair of pliers. After the repair is complete the tab can be re-opened by using an awl or similar instrument.

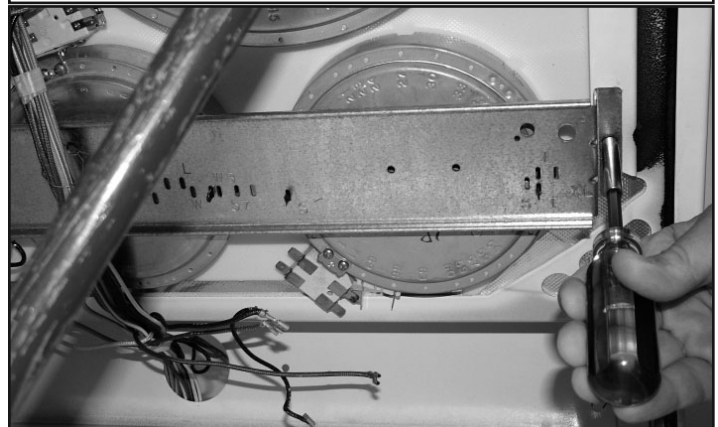

Removing and Replacing Surface Elements (continued)

5. Carefully pull the support channel away from the cooktop far enough to disengage the element mounting clips from the channel. Slide the element out from between the support channel and the cooktop. Reinstall or replace the element by reversing steps 1-5.

The element mounting clips must be removed from the original element and mounted to the replacement. The screw holes on the element body are numbered to identify the clip mounting locations.

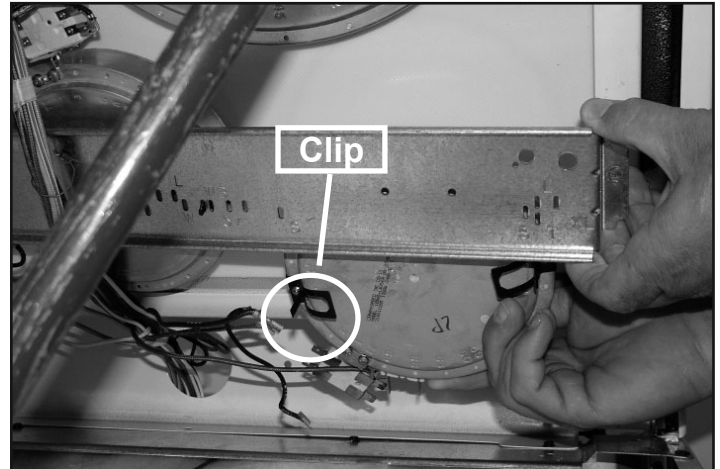

Surface Element Terminal Connections

When replacing the surface element, the terminal positions on the new element may be different from the original. Reconnect the wires according to the **terminal identification** (2A, 2B etc.) not by terminal position. The photos below show two different terminal block styles and illustrate the difference in the terminal positions.

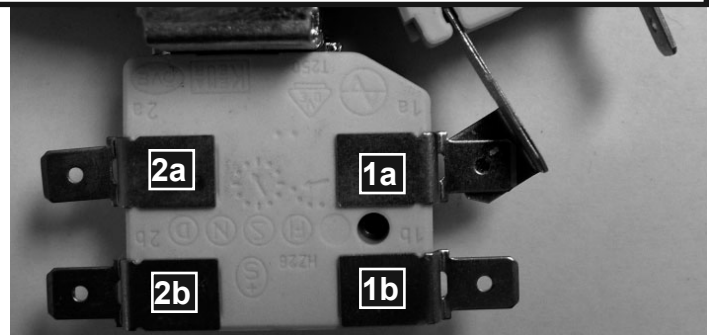
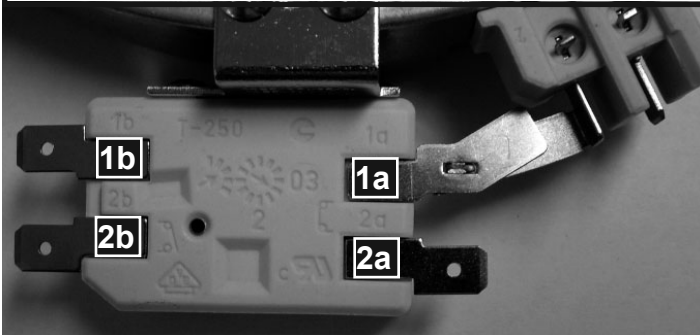

Warmer Drawer

The purpose of the Warmer Drawer is to keep hot cooked foods at serving temperature. Always start with hot food. It is not recommended to heat cold food in the Warmer Drawer. All food placed in the Warmer Drawer should be covered with a lid or aluminum foil to maintain quality.

The operation of the warmer drawer element is controlled by a separate rotary switch on the control panel. The element cycles on and off at varying rates in relation to the selected setting causing the temperature to increase or decrease. The actual temperature can also be affected by environmental conditions such as room temperature, air currents, and customer use. *The warmer drawer temperature is not precisely controlled and variations from the operating temperatures listed below are normal.*

For best results, preheat the drawer before adding food. An empty drawer will preheat in approximately 15 minutes.

WARMER DRAWER TEMPERATURE TABLE

Setting	HI	MED	LO
*Temp Range (°F)	180-200	160-180	140-160
* Temperatures are approximate			

Warmer Drawer Theory of Operation

The circuit diagram below shows a typical wiring and control setup for a warmer drawer on an electric or gas range. The warmer drawer is designed to operate on 120 VAC. The L1 wire on the warmer drawer switch is connected to L1 in the power supply harness and the L2 wire on the switch is connected to the neutral circuit in the harness. When the switch is turned on the contacts L1-H1 close connecting the L1 circuit to one side of the warmer drawer element. The contacts L2 - H2 also close completing the neutral circuit to the ½ wave diode which connects to the other side of the element. This circuit provides approximately 60 volts AC to the element resulting in lower wattage heat output from the element.

There is a parallel neutral circuit that provides neutral to the element through the Low Limit Thermostat. This circuit is always closed unless the temperature of the warmer drawer has reached the cut out point of the low limit thermostat. The purpose of this circuit is to allow the element to operate at full wattage and bring the drawer up to minimum operating temperature more rapidly. Once the low limit thermostat opens the circuit from H2 through the diode provides the neutral circuit to the element.

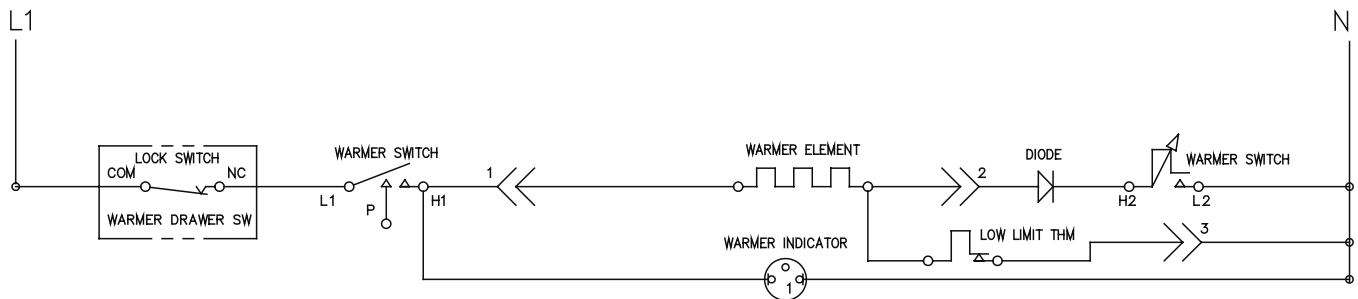

Troubleshooting Warmer Drawer Operation

The warmer drawer can fail in a variety of ways. If the element fails to heat at all you should test the switch contacts, element, low limit thermostat and all wiring connections and harness.

If the element heats only at low temperatures then the switch contacts L2-H2, diode, or wire harness or connections could be open.

If the warmer drawer overheats then the fault could be a shorted diode, low limit thermostat contacts stuck closed, element or wire harness shorted to ground. On a range that has just been installed it is also possible that there could be a miswired connection causing the overheat condition.

If it is determined that the diode is shorted then the warmer drawer wire harness must be replaced as an assembly.

Servicing Warmer Drawer Components

To service the warmer drawer body, drawer guides, or the element assembly first remove the warmer drawer by following the instructions on page 7 of this manual. Note that in order to release the latch on the right side of the drawer it is necessary to remove the latch lever shield by removing a ¼" hex head screw (see photo below). This screw and shield must be reinstalled when the drawer is replaced. Follow the instructions to reinstall the drawer after the repair or service is complete.

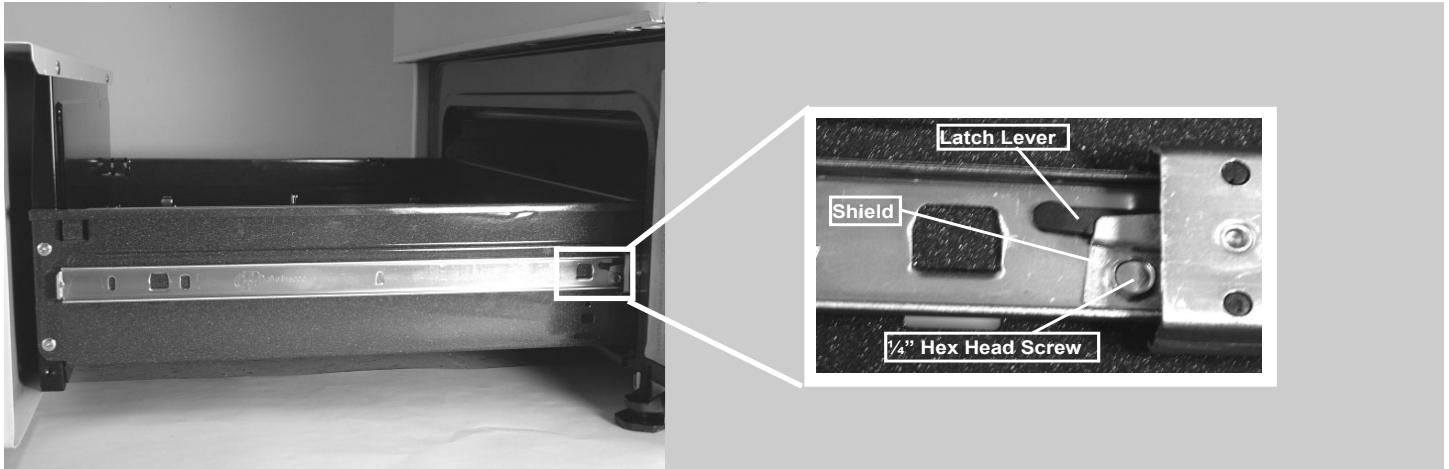

!CAUTION!

ALWAYS DISCONNECT OR TURN OFF THE POWER SUPPLY TO RANGE BEFORE REMOVING THE WARMER DRAWER

The warmer drawer element and thermostat are mounted to a metal base pan which must be removed in order to replace the element. To remove the base first go to the rear of the range and remove the screws that secure the warmer drawer base and the warmer drawer side shields to the main back panel. Also unplug the warmer drawer harness connector plug and push the connector through the slot in the back panel so that it can be removed with the element and base assembly.

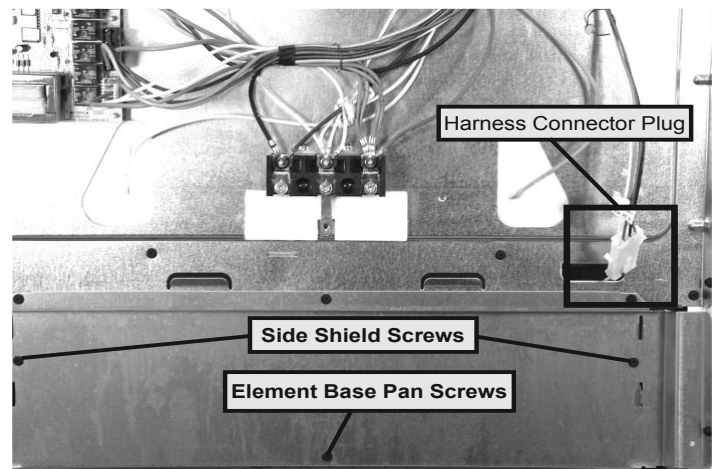

Remove the ¼" hex screws that secure the drawer guide rail and element base pan on each side of the drawer opening.

Remove the drawer guide rail and drawer shield together by pulling straight forward.

Once both of the drawer guide rails and side shields have been removed the base pan and element assembly can be pulled forward to remove from the range. See photo on page 18.

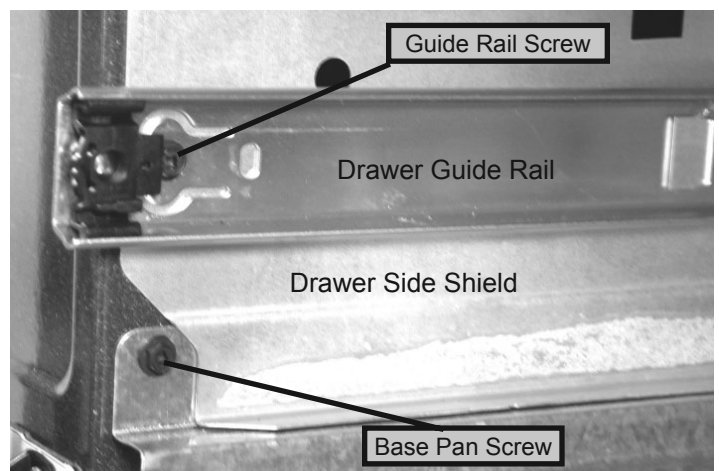

With the element and base pan assembly removed the element and thermostat are accessible for servicing. To dismount the element from the pan remove the screws and clips that secure it to the pan. Also remove the screw that secures the thermostat mounting bracket.

When reinstalling the thermostat mounting bracket always insure that the element terminal shield is installed and properly positioned.

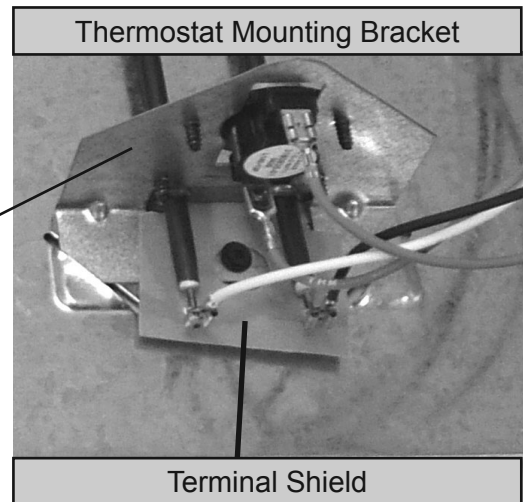
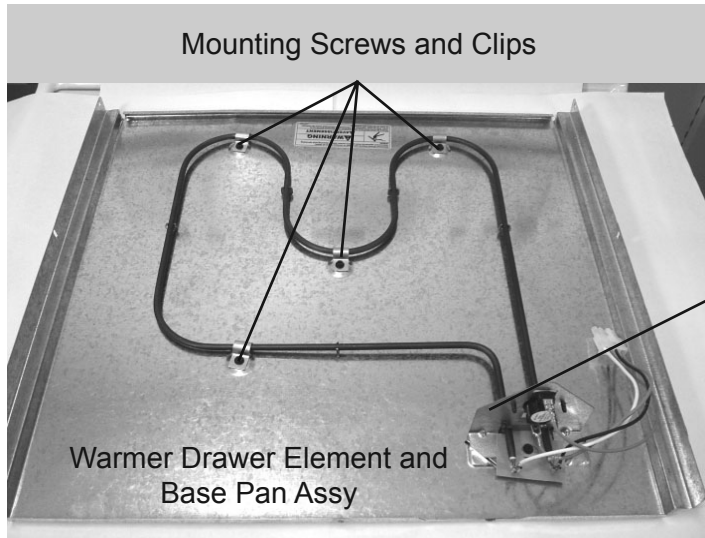
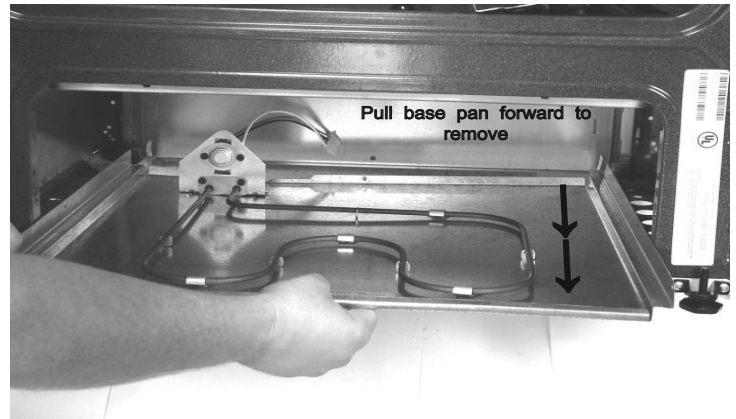

Oven Door

The door construction has changed substantially. In previous models the hinges were mounted to the chassis. The new construction moves the hinges to the interior of the door.

To service or replace many of the components of the oven, it is often necessary to remove the door from the range. Below are instructions for removing and reinstalling the oven door. This information is also found in the owners guide.

To Remove Oven Door:

1. Fully open the oven door (horizontal with floor).
2. Pull the door hinge locks on both left and right door hinges down from the oven frame completely towards the oven door (See photo A). A tool such as a small flat-blade screwdriver may be required.
3. Close the door until it contacts the hinge locks.
4. Firmly grasp both sides of oven door along the door sides (Do not use the oven door handle).
5. Lift the oven door hinge arms over the roller pins located on each side of the oven frame (See Photo B on page 19).

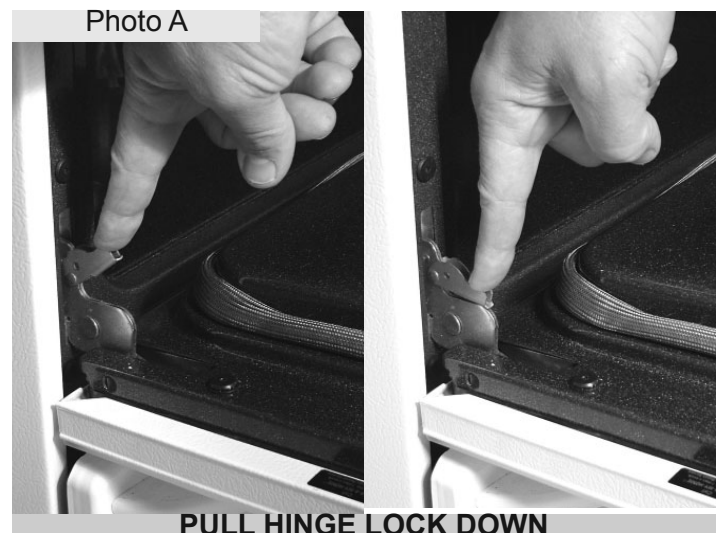

!CAUTION!

The door is heavy. For safe, temporary storage, lay the door flat with the inside of the door facing down.

To Replace Oven Door:

1. Firmly grasp both sides of oven door along the door sides (Do not use the oven door handle).
2. Holding the oven door at the same angle as the removal position, seat the hook of the hinge arm over the roller pins located on each side of the oven door frame.
3. Fully open the oven door (horizontal with floor).
4. Push the door hinge locks up towards and into the oven frame on both left and right oven door hinges to the locked position.
5. Close the oven door.



Door Hinge Replacement

Disassemble Door

1. Place the door with the handle side down on a protected work surface. The handle should hang off the edge of the bench or table.
2. Remove the bottom screws that secure the inner liner to the outer door panel. (Fig. 3)
3. Remove the two handle mounting screws and remove the door handle. (Fig. 4)

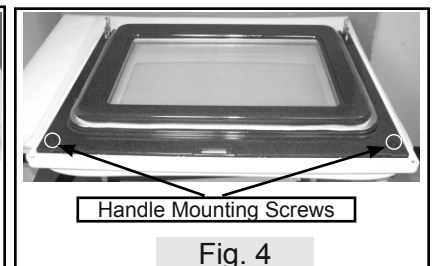
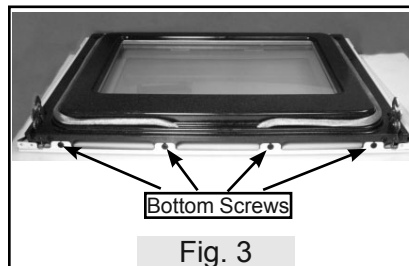

4. Carefully separate the inner door panel and hinge assembly from the outer panel. Place the assembly with the hinge side hanging slightly off the work surface.

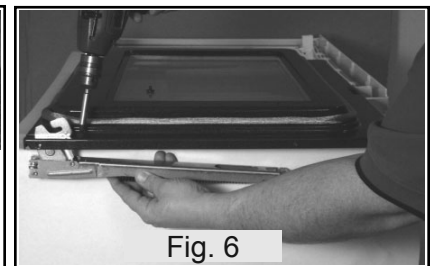
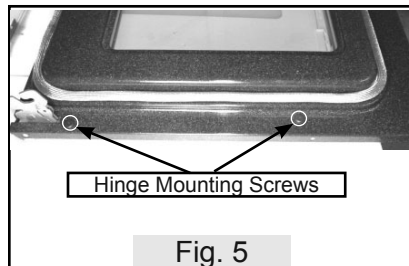

5. Remove the two hinge mounting screws and lower the hinge assembly away from the inner door panel. (Fig. 5 & Fig. 6).
6. Install new hinge and reverse the steps to reassemble the oven door.

TIP: TO EASE INSTALLATION OF NEW HINGE, INSTALL AND REMOVE THE SELF TAPPING SCREWS INTO THE SCREW HOLES IN THE NEW HINGE . THIS WILL PRE-CUT THREADS INTO THE HINGE AND ALLOW FOR EASIER STARTING OF THE SCREWS ONCE THE HINGE IS IN POSITION.

When replacing the door hinges you must ensure that the hinge lock lever is in the fully engaged position in order to reinstall the oven door on the range. The hinge is replaced as a complete assembly only.

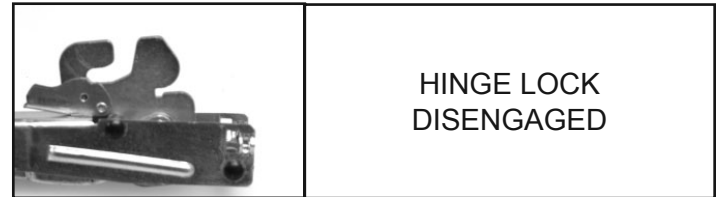

The same hinge assembly design is used for many different oven doors but with different door spring pull weights. The color of the door spring determines the pull weight. Make sure that the replacement hinge spring color is correct for the model that is being serviced.

Replacing Door Hinge Receptacle

The door hinges engage steel pins in the hinge receptacles which are mounted on the back side of the front chassis. The following instructions will explain the steps necessary for the various styles of ranges that you may encounter.

Begin by removing the oven door and warmer drawer or storage drawer as described in previous sections of this manual.

⚠ WARNING DISCONNECT OR TURN OFF ALL ELECTRICAL POWER AND GAS SUPPLY BEFORE SERVICING APPLIANCE

Remove warmer drawer side shields. (Models With Warmer Drawer)

1. From the rear of the range remove the screws that secure the shields to the main back panel (Fig1).
2. From the front of range remove the screws that secure the drawer glide rail (Fig 2).
The drawer glide rail and drawer shield can be removed together by pulling straight forward.

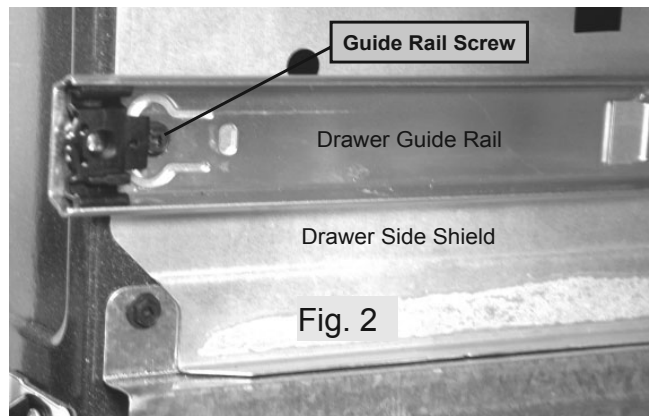
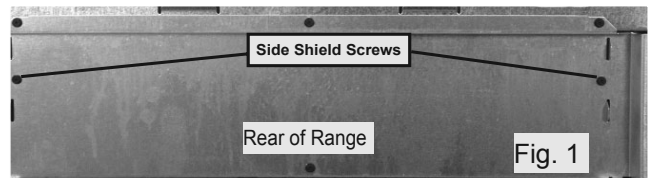

Remove hinge receptacle

1. Remove the two self tapping screws that secure the receptacle to the oven chassis frame (Fig 3).
The receptacle may fall into the body-side leg channel but it can be easily retrieved.

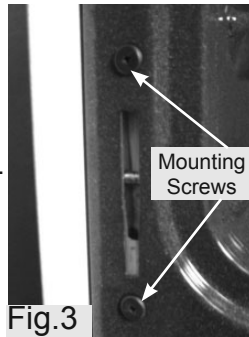

USE CAUTION TO AVOID BEING CUT BY ANY EXPOSED SHARP EDGES.

Install new receptacle

1. The new receptacle will have a black colored roller pin. Make sure to install the receptacle with the narrow end of the slot at the bottom (Fig. 4).

TIP: To ease installation of new receptacle, install and remove the self tapping screws into the screw holes in the new receptacle. This will pre-cut threads into the hinge and allow for easier starting of the screws once the hinge is in position.

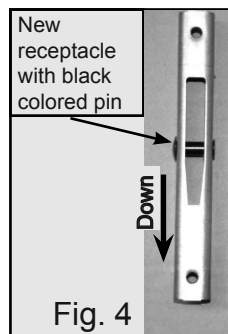

2. Carefully position the receptacle behind the front chassis and install the mounting screws (Fig. 5)
3. Reinstall warmer drawer side shields & glide rails, warmer drawer and oven door.

Replacing Door Hinge Receptacle Models with Bake-N-Warm™ Double Oven

To replace the hinge receptacles on range models that have a Bake-N-Warm™ Double Oven follow the instructions found on page 26 for removing the mini oven chassis. Once the chassis is removed the hinge receptacles can be replaced as outlined above.

Bodyside Mounting

Changing the body side panel requires the removal of screws along the top and rear flanges and removing the two screws securing the front leg leveler to the chassis.

When replacing the body side panels depending on the model there may be two hidden fasteners that must be addressed. The first is a screw on the inside flange of the body side just behind the face of the chassis as shown in the photo to the right.

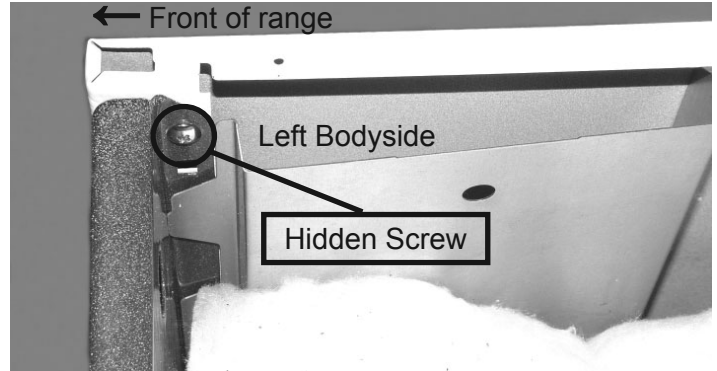

The second hidden fastener is located further down this same flange. The photo on the right shows a close up of the plastic retainer which is screwed to the side of the oven chassis. A square opening in the side panel hooks on the underside of the fastener. Lower the body side panel to disengage the slot from the retainer.

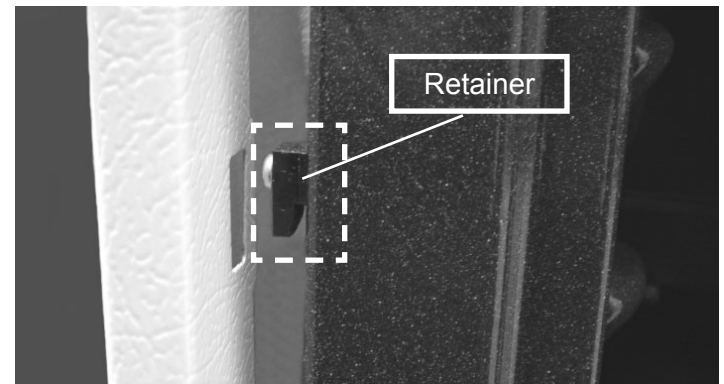

NOTE: This second fastener will not appear on all models

Leg Levelers

A newly designed, front mounted leg leveler has been added to provide for greater stability and easier access for adjustment. The new leveler is attached to the range two screws in the front that pass through the lower edge of the body side and into the oven chassis, and one screw from beneath that attaches to the body side panel.

NOTE: The front and rear leg levelers must be removed from the original bodyside panel and mounted on the new one before it is installed on the range.

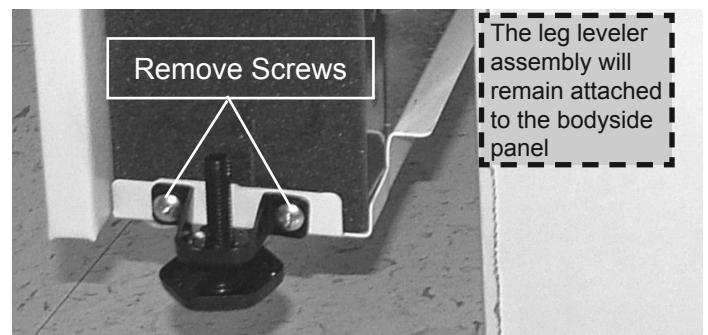

Bake-N-Warm™ DOUBLE OVEN

The Bake-N-Warm Double oven, or “Mini Oven” as it is commonly referred to, is located in the area normally used for the storage drawer. It can be used for baking or as a warmer drawer. See the photo at right.

The Mini Oven is ideal for cooking foods such as pizza, casseroles, baked potatoes and frozen convenience foods. The mini oven temperature range is from 170° F to 450° F in bake mode, and from 150° F to 190° F in warmer drawer mode.

The purpose of the Warmer Drawer feature is to keep hot cooked foods at serving temperature. Always start with hot food. It is not recommended to heat cold food in the Warmer Drawer.



Mini Oven Operation

The mini oven utilizes a separate solid state control board and temperature sensor probe to control oven operation and temperature. The control board incorporates a potentiometer that the customer rotates to the desired temperature setting. The temperature sensor probe is similar in appearance to the sensor for the main oven and it has the same resistance/temperature values. The mini oven bake element operates on 120 volts AC and is mounted beneath the drawer.

When the mini oven control is turned on the relay completes the circuit between P2 and P1 providing voltage from L1 to one side of the bake element. The other side of the bake element is connected to the neutral wiring harness of the range terminal block.

The mini oven control is powered by the main oven electronic oven control. When the main oven control is in self clean cycle or when the child safety lock has been activated the power supply to the mini oven control is interrupted and the mini oven will not operate. If the mini oven is in use at the time that the self clean cycle begins or the child safety lock feature is activated, the 15 volt DC power supply to the mini oven control board will be interrupted and the mini oven will cease operation.

Special Notes for ESEC Ranges: The mini oven will not operate when the main oven is set for Self-Cleaning or the Oven Control Lockout feature is active. If the mini oven is ON and a Self-Clean or Oven Control Lockout request is attempted, the EOC will deny the request with a triple beep.

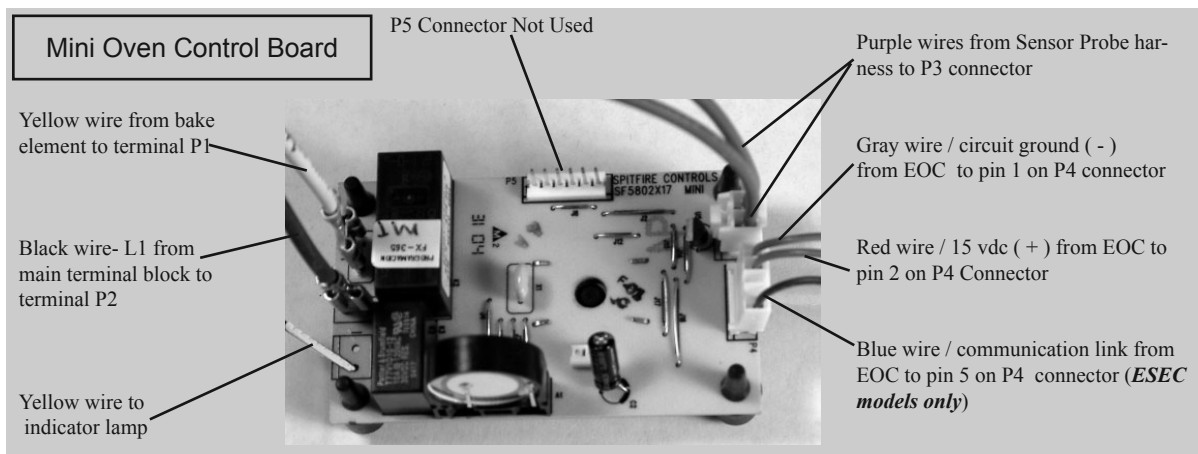

Diagnosing Mini Oven Failure

If the mini oven fails to operate properly follow the same basic diagnostic steps that are used for any oven. Verify the power supply, check the wiring connections, test the heating element and temperature sensor probe.

⚠ Warning Use extreme care when testing circuits with live voltage present.

If the mini oven control fails to send voltage to the element perform the following tests to determine the cause of failure.

1. With the range connected to the power supply test for 120 volts AC from the black wire on mini oven control P2 to neutral or chassis ground. If the voltage is incorrect check the power supply to the range and the wiring harness between the control and main terminal block.

2. If the voltage is correct to terminal P2 verify that the mini oven control board is receiving the required power supply from the main oven EOC. If the mini oven indicator light glows when the control is activated then the power supply is good. If the light does not glow test for 15 volts DC at the Red (+) and Gray (-) wires on the P4 connector of the mini oven control. If the voltage is correct then the failure is in the mini oven control board. If the voltage is incorrect the failure is in the wiring harness or the EOC.

3. The mini oven control will beep constantly when it detects a fault condition in the temperature sensor circuit. This could be caused by a runaway heat condition, open / shorted temperture probe, faulty probe connection or harness. Test the temperature sensor probe circuit by disconnecting the P3 connector at the control board and measuring the resistance between the two purple wires. The resistance of the mini oven temperature probe is the same as that of the main oven temperature probe. If the probe circuit and harness are good replace the mini oven control board.

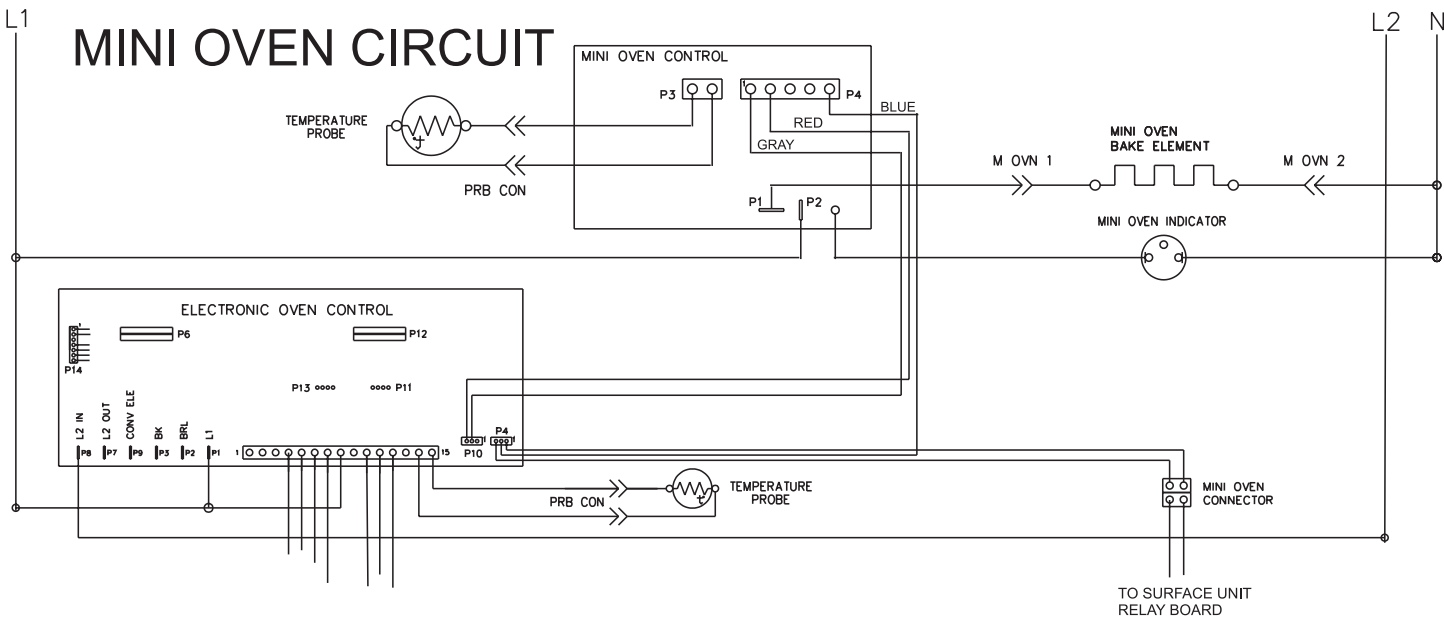

Mini Oven Component Service

Replacing Mini Oven Element

Remove Drawer

1. Before drawer removal, be sure to turn OFF the Bake-n-Warm™ Double Oven and let the drawer area cool completely.
2. Open the drawer to the fully open position. Using a phillips-head screwdriver remove the two drawer screws from the insides of the front oven drawer compartment (See Fig. 1).
3. With one hand hold the drawer front in place. Use your other hand to pull the glide away from the oven (See Fig. 2) until the glide hook disengages (See Fig. 3 & Fig. 4).
4. Repeat from step 3 above for the other side of the drawer.
5. With BOTH glide hooks disengaged, carefully lift the drawer up and away from the oven. Push both drawer glides into lower oven cavity.

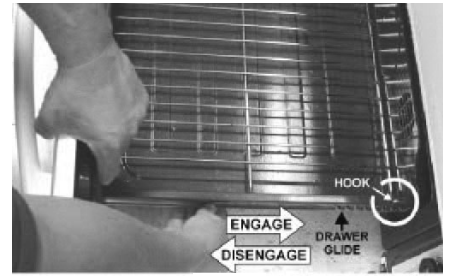
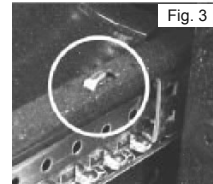
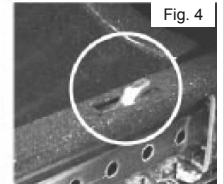

Fig. 2



Glide Hook Disengaged



Glide Hook Engaged

From the rear of the range remove the six screws that secure the lower rear shield. (Fig. 5)

Note that the center screw in the upper edge of the panel is concealed behind the power cord. It may be necessary to remove the cord to access this screw.

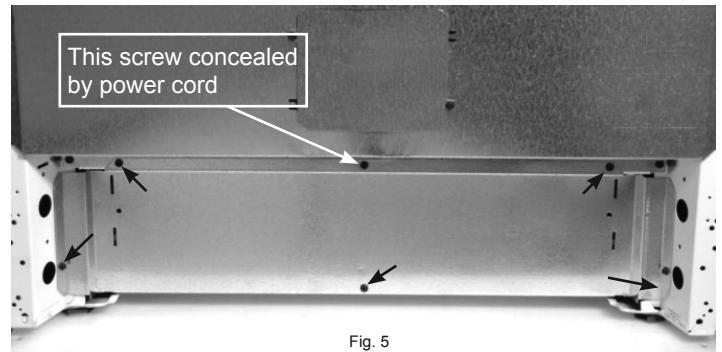

Fig. 5

After the shield is removed the wire terminals to the mini oven element and light can be accessed. (Fig. 6)

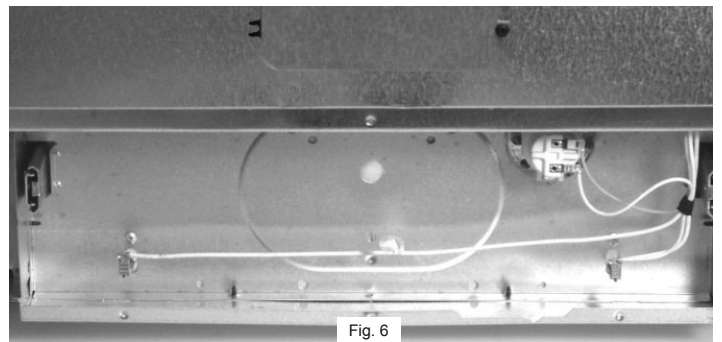

Fig. 6

With the drawer removed and the element wire harness disconnected remove the eight screws that secure the element to the base and remove the element by pulling forward. (Fig. 7)

To remove the mounting screws a short / stubby 1/4" nut driver or # 1 square drive screwdriver is required.

Use caution when working in this area. There are sharp edges on the element brackets and other areas. Protective clothing and / or gloves are recommended.

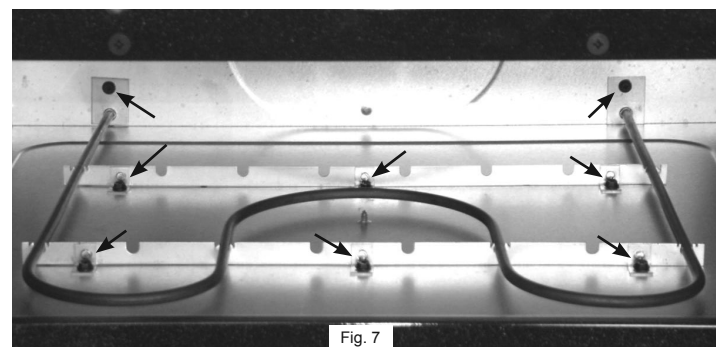
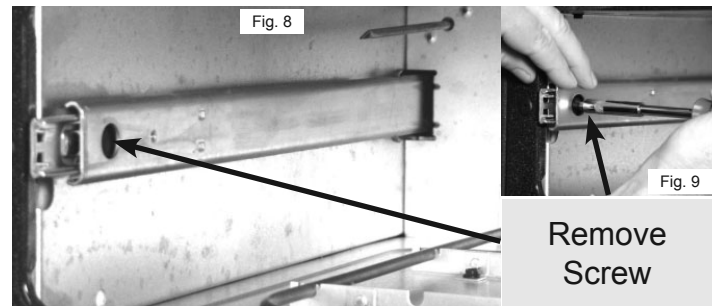

Fig. 7

Replacing Drawer Glide Rails

The mini oven drawer glide rails (Fig. 8) clip into the side wall of the mini oven cavity and are secured by one screw in each rail.

The mounting screw is accessed through a hole in the glide rail outer track. (Fig. 9) .



Once the mounting screw is removed extend the outer track of the glide rail until it stops. Pull forward firmly until the hooks on the back of the rail disengage from the slots in the oven cavity side wall. (Fig. 11 & 12)

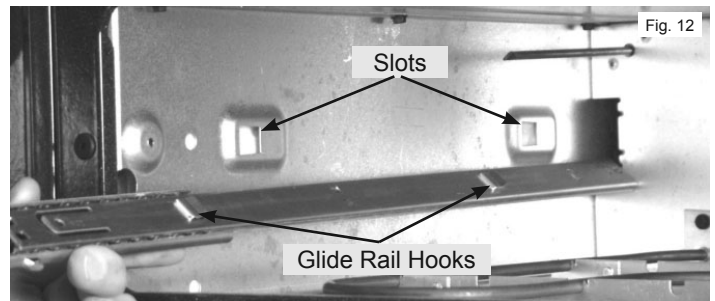
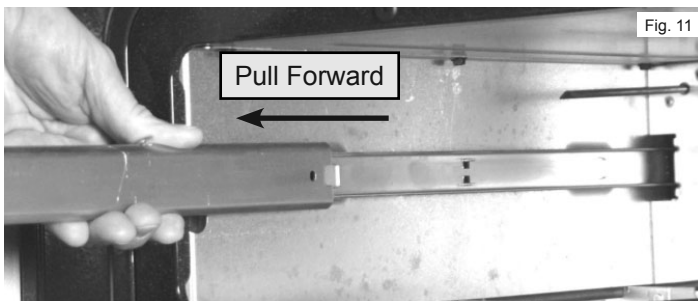

Replacing Drawer Seal and Magnet Latch

The Mini Oven drawer is held closed by two magnetic latches, one on each side of the drawer. The magnets engage metal strike plates that are secured to the front frame of the range chassis. The strike plates are held to the chassis by a flat head screw that passes through a stand off spacer and into the chassis.

It is normal for the strike plate to be moveable when the screw is properly tightened.

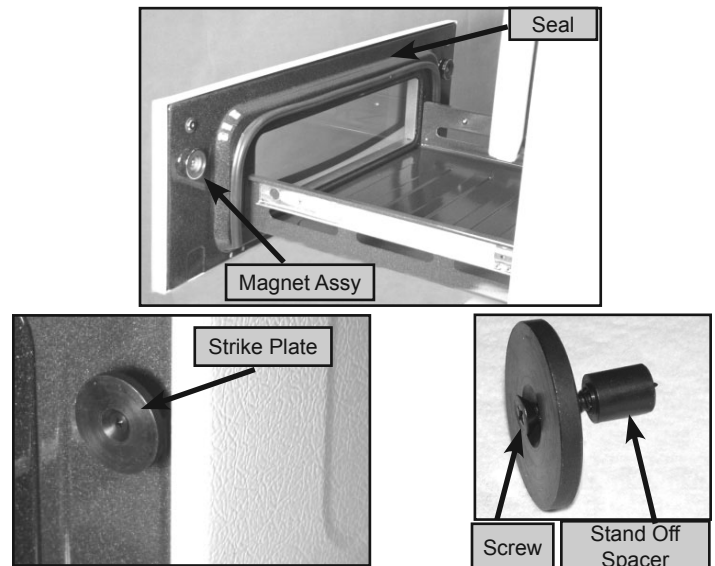

The rubber drawer seal is secured to the drawer liner by metal spring clips that are integral to the seal. To remove the seal grasp securely at the clip and pull away from the liner. Replace by positioning the point of the clip into the hole and pressing in until the clip locks into place.

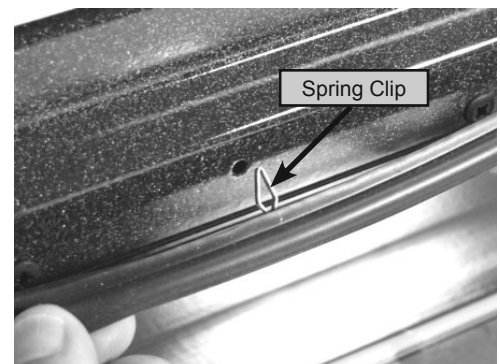

Mini Oven Chassis

The mini oven chassis can be removed as an entire assembly. Begin by disconnecting the wire harness connections to the element and cavity light.

Remove the drawer per instructions on page 26.

Using a 1/4" nut driver with magnetic screw holder remove the two screws securing the mini oven chassis to the range chassis. These screws are accessed through the holes in the mini oven cavity liner just below the drawer glide rail. (Photo A).

The mini oven chassis can now be pulled forward and removed from the range. (Photo B).

With the mini oven chassis removed the insulation and chassis panels can be serviced.

NOTE: The mini oven chassis can not be ordered as a complete replacement assembly.

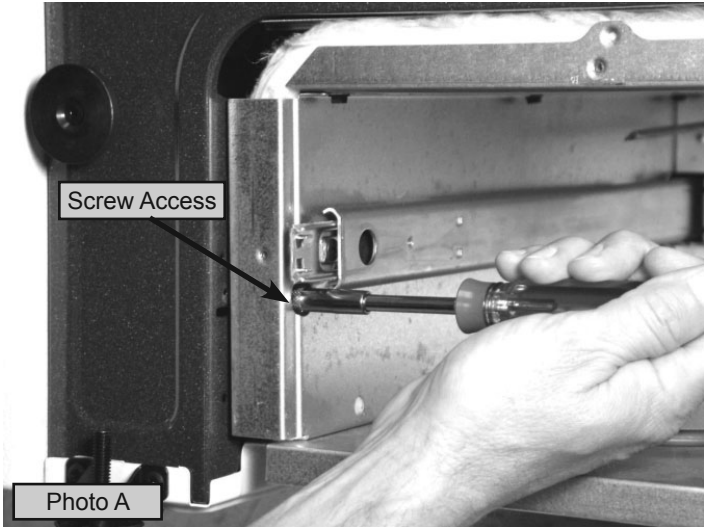

COMPONENT TESTING

Many of the range component circuits can be tested at the EOC wiring harness connections with an ohm meter. By following the wiring diagram and schematic diagram it is possible to perform continuity tests on the bake and broil elements, lock motor windings, oven door switch and oven lamp circuits. When testing for continuity the power supply must be turned off or disconnected and the wire harness connector(s) for the circuit or component being tested must be unplugged from the EOC.

EXAMPLE: To test the Broil element circuit unplug the L2 out (orange wire) and BR (blue wire) from the EOC. With an ohm meter test for continuity between these two wires. If the circuit is open then the broil element may be defective or there could be a failure in the wire harness or connection. Refer to the Component Resistance Chart on the following page for resistance values of various components

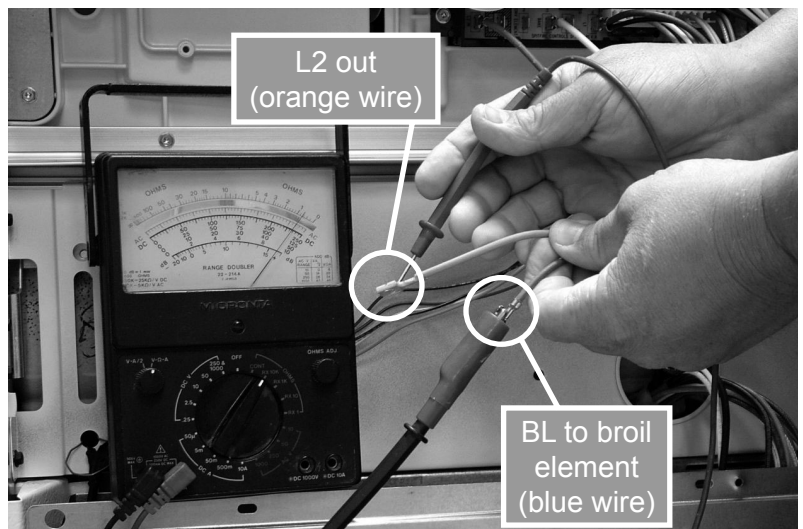

Electric Range Component Resistance Chart

NOTE: Resistance measurements are approximate. Variations due to temperature changes and other factors are normal.

Component	Voltage Rating	Wattage	Resistance Ω (ohms)
Bake Element	208 / 242	2500	23
Bake Element	208 / 242	2600	22
Bake Element	208 / 242	3500	16
Mini Oven Element	108 / 232	1500	9.6
Warmer Drawer Element	108 / 232	700	20.5
Warmer Drawer Element	108 / 232	450	32
Broil Element	208 / 242	4000	14
Broil Element	208 / 242	3000	19
Convection Element	108 / 232	350	40
8" Coil Surface Element	208 / 242	2100	27.5
6" Coil Surface Element	208 / 242	1250	46
6" Radiant / warmer Element	108 / 232	100	144
6" Radiant Surface Element	208 / 242	1200	48
5" / 7" Expandable Radiant Element	208 / 242	1800 / 1350	Outer / Inner 128 / 42
6" / 9" Expandable Radiant Element	208 / 242	2500 / 1875	Outer / Inner 92 / 31
6" / 9" Expandable Radiant Element	208 / 242	2500 / 1200	Outer / Inner 44 / 48
6" / 9" Expandable Radiant	208 / 242	3000 / 1400	Outer / Inner 35 / 40
8" Radiant Surface Element	208 / 242	2200	26
9" Radiant Surface Element	208 / 242	2500	24
9" / 12" Expandable Radiant Element	208 / 242	2700 / 1700	Outer / Inner 52 / 33
Convection Fan Motor Windings	108 / 232		15
Lock Motor Windings	108 / 232		2000

Electronic Oven Controls

The newest generation of Electronic Oven Controls have significant improvements to make them easier for the consumer to operate and provide enhanced diagnostic tools for the service technician. Below are examples of the current control configurations that can be found on freestanding electric self cleaning ranges. The controls for non self clean ranges have not changed.

ES 200 Control Features:

- Full slew up / down control
- Digital Time and Temperature Display
- Electronic Clock and Countdown Timer (12 Hour)
- Dual Radiant™ Baking (electric models)
- Variable broil (2 positions)
- Consumer selectable clean cycle (3 hour default - 2 hour optional)
- 12 hour energy saving shut-off with override for continuous operation
- Selectable F° or C° temperature readout
- Control Lockout (disables oven and locks door)
- User Adjustable Oven Temperature Offset



ES 300 Control Features:

- Automatic oven (Delay, Cook, and Off)
- Full slew up / down control
- Digital Time and Temperature Display
- Electronic Clock and Countdown Timer (12 Hour)
- Dual Radiant™ Baking (electric models)
- Variable broil (2 positions)
- Consumer selectable clean cycle (3 hour default - 2 hour optional)
- 12 hour energy saving shut-off with override for continuous operation
- Selectable F° or C° temperature readout
- Control Lockout (disables oven and locks door)
- User Adjustable Oven Temperature Offset

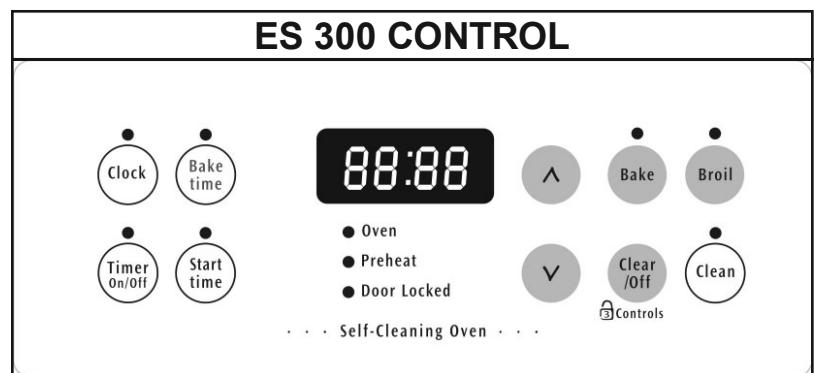

ES 330 Control Features:

- Automatic oven (Delay, Cook, and Off)
- Full slew up / down control
- Digital Time and Temperature Display
- Electronic Clock and Countdown Timer (12 Hour)
- Dual Radiant™ Baking (electric models)
- Variable broil (2 positions)
- Consumer selectable clean cycle (3 hour default - 2 hour optional)
- 12 hour energy saving shut-off with override for continuous operation
- Selectable F° or C° temperature readout
- Individual Keypad for Control Lockout (disables oven and locks door)
- Oven Light Switch in control.
- User Adjustable Oven Temperature Offset



ES 340 Control Features:

- Automatic oven (Delay, Cook, and Off)
- Full slew up / down control
- Digital Time and Temperature Display
- Electronic Clock and Countdown Timer (12 Hour)
- Dual Radiant™ Baking (electric models)
- Variable broil (2 positions)
- 2 Pre - programmed clean cycles (2 hour **Speed clean** - 3 hour **Clean**)
- 12 hour energy saving shut-off with override for continuous operation
- Selectable F° or C° temperature readout
- Control Lockout (disables oven and locks door)
- Oven Light Switch on control.
- User Adjustable Oven Temperature Offset

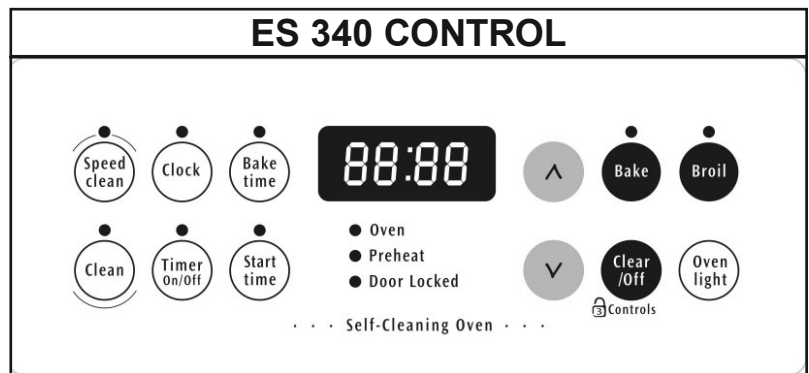

ES 510 Control Features:

- Convection Bake and Convection Roast settings
- Automatic Convection Conversion feature
- Sabbath Mode (Star-K Certified)
- Keep Warm Feature - Maintains 170°F oven temperature for up to 3 hours.
- Favorite Setting - User can program and store up to 3 different bake or timed bake cycles
- Automatic oven (Delay, Cook, and Off)
- Numeric Keypad Temperature Selection
- Digital Time and Temperature Display
- Electronic Clock and Countdown Timer (12 Hour)
- Dual Radiant™ Baking (electric models)
- Variable broil - Temperature adjustable between 400°F & 550°F
- 3 Pre - programmed clean cycles (2 hour **Speed clean** - 3 hour **Clean** - 4 hour **Maxx clean**)
- 12 hour energy saving shut-off with override for continuous operation
- Selectable F° or C° temperature readout
- Control Lockout (disables oven and locks door)
- Oven Light Switch on control.
- User Adjustable Oven Temperature Offset



Troubleshooting Electronic Oven Controls

When an oven with an electronic control detects a failure condition, it usually signals the failure with an “F” code. These “F” codes are considered by many people to be an indicator as to positively which part in the circuit has failed (“F1” a defective control, “F3” a defective oven probe, and so on). To the embarrassment of many servicemen who have believed this, they have installed the indicated part only to find it did not correct the problem.

To troubleshoot an oven with an electronic oven control that is not operating:

1. Make sure electrical power is being supply to the control. Verify this by testing the voltage at the control wiring harness.
2. Disconnect power for 30 seconds. If fault returns when power is reconnected continue with the following steps.
3. Remove electrical power.
4. Go to the back of the control and disconnect the multi-pin plug.
5. Check the wiring diagram to determine which two pins in the plug (not on the EOC) are connected to the oven sensor.
6. With an Ohmmeter check the resistance between the two pins in the plug that are connected to the of sensor. At room temperature:
 - If the meter reads below 900 Ohms or above 1200 Ohms, remove the sensor from the oven an check it for resistance. If the resistance of the sensor is the same as reading at the plug, the sensor is defective.
 - If the resistance of the sensor reads between 900 & 1200, the wiring between the control and the sensor is defective.
 - If the meter reads between 900 Ohms & 1200 Ohms check the resistance between one of the pins going to the sensor and chassis. If the meter reads infinity go to step 3. If the meter shows continuity, remove the sensor and check from one of its pins to the case of the sensor. If the meter reads continuity, the sensor is defective. If the meter reads infinity, the wiring between the control and the sensor is shorted to chassis of the range.
 - From the wiring diagram, determine which wires in the plug is from the door lock switch or switches. From the diagram determine which of the switches are open or closed when the door in the unlocked position. With an Ohmmeter check to see if the switch that is shown open is open and the switch that is shown closed is closed by checking the proper pins in the plug.
7. If the above checks test good and the relay on the board for the selected function is not closing replace the control.

IMPORTANT: If the oven problem is intermittent you must do the above test when the oven is malfunctioning.

EOC FAILURE / FAULT CODES

On freestanding gas and electric ranges manufactured beginning with the serial number date code **VF426** many of the EOC's will have expanded three digit fault codes. These codes may also appear in new replacement EOC's for ranges built prior to this date. Below is a list of possible fault codes that might appear in the EOC display window. The original two digit fault codes appear in the shaded boxes followed by the replacement three digit codes.

For each Fault code there is a listing of the likely failure condition or cause, as well as suggested corrective actions to be taken. Not all fault codes will appear in every model but the fault codes are universal and have the same meaning regardless of the model that is being serviced

Note: Fault codes are not a foolproof system. Never assume that a part has failed based on a displayed fault code. An example would be if the EOC is displaying F30 (open sensor), the failure could be caused by a loose connection or faulty wire harness between the EOC and sensor or the sensor could simply be unplugged.

FAULT CODE	LIKELY FAILURE CONDITION/CAUSE	SUGGESTED CORRECTIVE ACTION
F1	F10 Runaway Temperature. F11 Shorted Keypad. F12 Bad Micro Identification. F13 Bad EEPROM Identification/Checksum error. F14 Display tail missing/not connected	1. (F10 only) Check RTD Sensor Probe & replace if necessary. If oven is overheating, disconnect power. If oven continues to overheat when the power is reapplied, replace EOC. Severe overheating may require the entire oven to be replaced should damage be extensive. 2. (F11, 12 & 13) Disconnect power, wait 30 seconds and reapply power. If fault returns upon power-up, replace EOC. 3. (F14 only) Re-seat the P12 ribbon connector tail. If fault returns replace EOC (first action); Touch Panel (second action)
	F20 Communication failure between EOC and ESEC system. F26 Communication failure with mini oven control.	1. Test harness/connections P4 (EOC) & P11 (Surface element control board). 2. If harness checks O.K. failure can be caused by faulty UIB, surface element control board, or EOC. Check harness and connectors from the EOC to mini oven control board. Check for 15vdc to mini oven control (red & gray wires). If harness and voltage are good replace mini oven control. If fault returns replace EOC.
F3	F30 Open probe connection. F31 Shorted Probe connection	1. (F30 or F31) Check resistance at room temperature & compare to RTD Sensor resistance chart. If resistance does not match the RTD chart replace RTD Sensor Probe. Check Sensor wiring harness between EOC & Sensor Probe connector. 2. (F30 or F31) Check resistance at room temperature, if less than 500 ohms, replace RTD Sensor Probe. Check for shorted Sensor Probe harness between EOC & Probe connector.
	F40 Cooktop Lockout error. F41	1. (F40 or F41) Check the wiring. 2. (F40 or F41) Replace the Cooktop Lockout Control Board. 3. (F40 or F41) Replace EOC.
F9	F90 Maximum oven door unlock time exceeded. F91 Maximum oven door unlock attempts exceeded. F92 Maximum oven door open time exceeded. F93 Maximum oven door lock time exceeded. F94 Maximum oven door lock attempts exceeded.	1. (F90, 91, 92, 93 & 94) Check the wiring between EOC & Lock Motor Micro Switch. 2. (F90, 91, 92, 93 & 94) Replace the Motor Door Latch assembly if necessary. 3. (F90, 91, 92, 93 & 94) Check for binding of the Latch Cam, Lock Motor Rod & Lock Motor Cam. 4. (F90, 91, 92, 93 & 94) Check to see if Lock Motor Coil is open. If open, replace Lock Motor Assembly. 5. (F90, 91, 92, 93 & 94) Lock Motor continuously runs - if Micro Switch is open, replace Lock Motor Assembly. 6. (F92, 93 & 94) Check oven door Light Switch - if open, replace Switch. 7. If all situations above do not solve problem, replace EOC.

ES 510 ELECTRONIC OVEN CONTROL

The ES510 control is found on electric ranges with the ESEC 10R system. It has some unique features and functions not found on other EOC's. This section of the manual provides specific service information for the ES 510 Electronic Oven Control.

The ES510 controls the bake element, broil element, oven light, latch lock motor, convection fan motor and convection element. The EOC also communicates with the ESEC system in order to prevent use of the cooktop surface elements while performing a self clean cycle. If the EOC detects that a surface element is in use it will not allow the operator to program a self clean cycle or cooktop lockout. If the oven is in a self clean cycle the EOC communicates with the ESEC and the surface elements are locked out until the clean cycle is completed and the oven door has unlocked. The EOC also disables the warmer drawer and cooktop warming zone during the self clean cycle.

On ranges with a Bake-N-Warm™ Double Oven (mini oven) the EOC provides the power supply to the control board for this oven and also communicates with the control to lock out the mini oven during a self clean cycle or to prevent programming a self clean cycle if the mini oven is in use.

Troubleshooting the ES510 EOC

The ES510 continually performs tests on it's internal circuits as well as certain external components and operations. When a failure occurs the EOC will emit an audible signal and display the code associated with that particular failure.

Following are some examples of displayed Failure Fault Codes. The Failure Fault Code list found on page 29 provides a full listing of possible fault codes, the likely cause and suggested corrective action.

F30 ERR If the EOC detects that the oven temperature probe circuit is OPEN during the initial power up you will not be able to program the time of day and the EOC will display "F30 ERR" and the alarm will sound when you attempt to set the time.



F31 If the EOC detects that the oven temperature probe circuit is SHORTED during the initial power up the EOC will continue to flash "12:00" in the display accompanied by an audible clicking of the relay circuit in the EOC. You will not be able to program the EOC or use the surface elements.



If at any time the EOC detects that the oven temperature probe circuit resistance is less than 800Ω The EOC will display "F31" and the alarm will sound.

If either of the above conditions is encountered, turn off the power to the range and test the oven temperature probe circuit.

F10 ERR - The EOC detects a runaway heat condition. Check RTD Sensor Probe & replace if necessary. If oven is overheating, disconnect power. If oven continues to overheat when the power is reapplied, replace EOC. Severe overheating may require the entire oven to be replaced should damage be extensive.



F11 ERR - Shorted control keypad. Disconnect power, wait 30 seconds and reapply power. If fault returns upon power-up, replace EOC.

NOTE: This failure code can be induced by holding down on a keypad for more than 20 seconds.



F20 ERR - Communication failure between EOC and ESEC system. Test harness/connections P4 on EOC & P11 on Surface element control board. If harness checks O.K. failure can be caused by faulty UIB, surface element control board, or EOC.



IMPORTANT NOTES when using the Self-Clean feature:

If a Self-Cleaning-Cycle has started but not finished and a power failure occurs, once power is restored the Cooktop will remain locked. To unlock the cooktop press and hold the **Clock** pad for 3 seconds. The red cooktop lock icon will disappear from the display. Then set for another Self-Clean cycle to finish.

EOC Wire Harness Connections

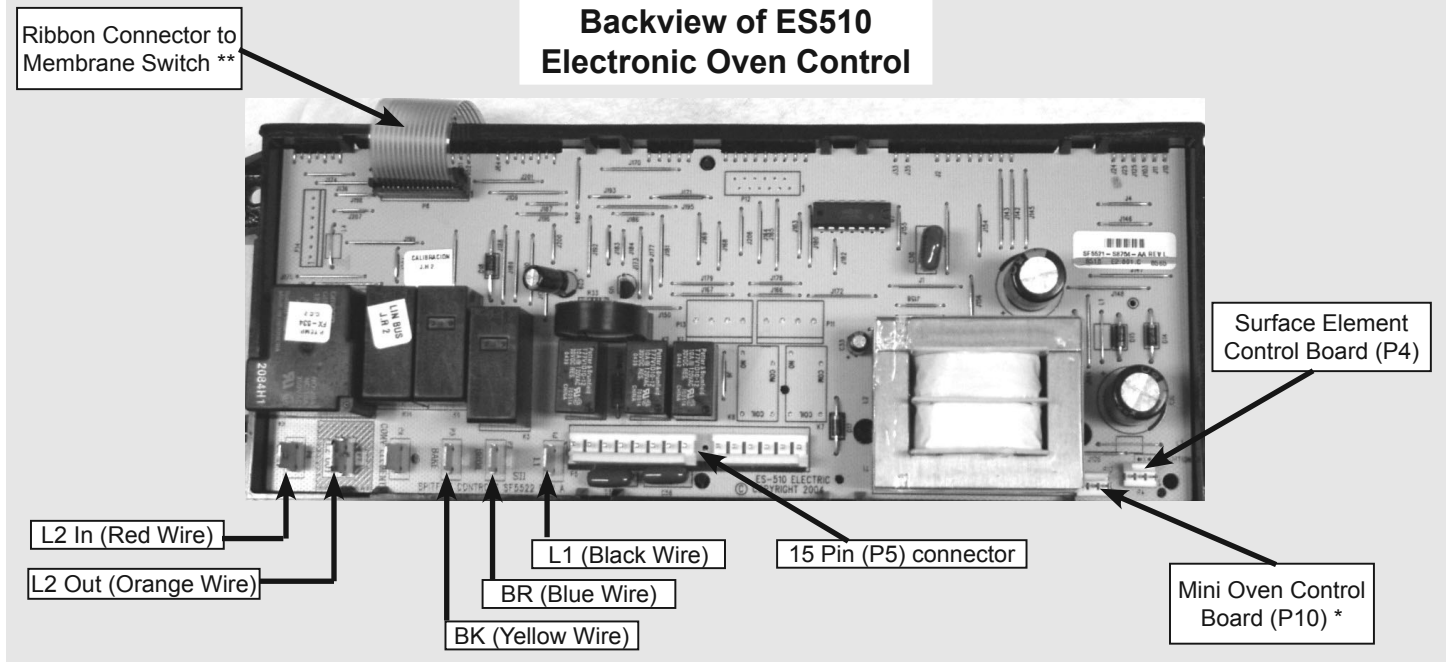

* Not found on all models

** Membrane switch can not be replaced as a separate part

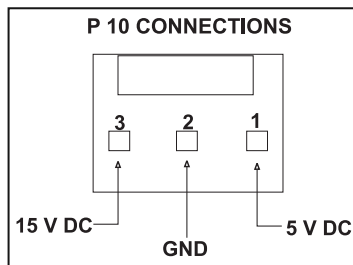
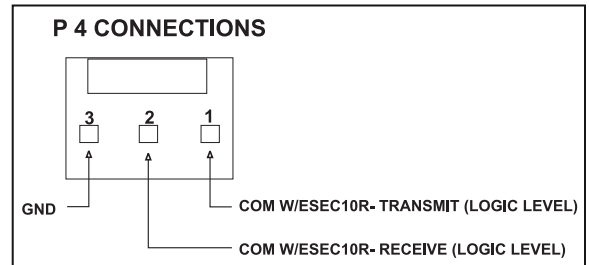
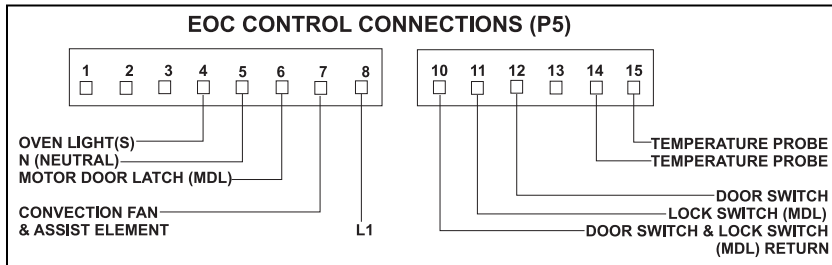

The EOC relay circuits can be tested by following the circuit test matrix at right. Always verify the incoming power supply when performing diagnosis.

ES510 EOC RELAYS - CIRCUIT TEST MATRIX							
	L1 to Bake	L1 to Broil	L1 to Motor Door Latch	L1 to Convection Fan & Element	L1 to Oven Light(s)	L2 IN to L2 OUT (DLB)	Door Switch COM-NO
Bake/Time Bake **	X	X*				X	
Convection Bake/Roast	X	X*		X		X	
Broil		X				X	
Clean	X					X	
Oven Light(s)					X		
Locking			X				
Unlocking			X				
Door Open					X		
Door Closed							X
Warmer Drawer							
Warming Zone (Cooktop)							

NOTE: X = Relay Contacts Closed * = Alternates with Bake Element

The Component Test Point Matrix below provides a list of each of the components that can be tested from the P5 harness connector on the back of the EOC. Disconnect the harness before performing a component circuit test. A chart with the various component resistance values can be found on page 28.

COMPONENT TEST POINT MATRIX (ES 510)

COMPONENT	EOC HARNESS TEST POINT LOCATION
BROIL ELEMENT	L2 OUT (orange wire) - BR (blue wire)
BAKE ELEMENT	L2 OUT (orange wire) - BK (yellow wire)
DOOR SWITCH	P5 harness terminals 10 & 12 (gray wire - pink wire)
TEMPERATURE SENSOR PROBE	P5 harness terminals 14 & 15 (violet wire-violet wire)
LATCH MOTOR	P5 harness terminals 5 & 6 (white wire - brown wire)
OVEN LAMP(S)*	P5 harness terminals 4 & 5 (tan wire - white wire)

* Circuit will show continuity even if only one bulb is good. Check inoperative bulb(s) individually.

Sales Demo Mode

A sales demo (SD) mode is available in the ES510 control that allows the control panel functions to be demonstrated without turning on any heating elements. To enter or exit the SD mode disconnect power to the range. Reconnect the power and within 45 seconds touch the  keypad on the EOC and hold until "sd" appears in the EOC display (approximately 6 seconds). The ESEC display windows will also display "sd" momentarily and then go blank. The time of day display will blink until the clock is set. In the Sales Demo mode all control panel and display functions can be demonstrated but the elements will not heat.

To exit the Sales Demo mode you **must** repeat the procedure used to enter the Sales Demo mode. Disconnect the power to the range; reconnect the power and within 45 seconds touch and hold the  pad until the "sd" display disappears. You can not exit the Sales Demo mode by pressing the Stop/Clear keypad or by resetting the power to the range.

ELECTRONIC SURFACE ELEMENT CONTROL (ESEC) SYSTEM VERSION 10R

The Electronic Surface Element Control System (ESEC), precisely controls the smoothtop cooking elements at multiple settings. (The Warming Zone element is not controlled by the ESEC). For the user, the elements are operated in the same way as with conventional controls, by pushing in and turning the knob to the desired setting. The setting is shown in the digital display above the knob, instead of using graphics on the control panel.

ESEC Hot Element Indicator (“HE”) - While an element surface is hot, that element’s display will show “HE”. This is in place of the usual hot surface indicator light on ranges with conventional controls. Note that “HE” will be displayed even when the element is turned off until it has sufficiently cooled down.

ESEC Lockout Feature (“- -”) - The electronic oven control’s Clean and Lock features will not operate when a surface element is ON. Conversely, the surface elements controlled by the ESEC will not operate when an oven control Clean or Lock mode is active. When the oven control is in a Clean or Lock mode, “- -” will appear in the ESEC displays to signify that the surface elements are locked out. NOTE: The “HE” (hot element) display will always have priority over the “- -” display.

Previous versions of the ESEC system utilized a separate UIB / Display board assembly for each side of the range. The ESEC 10R has only one UIB with attached wiring harnesses to connect to the four potentiometers

ESEC System Components - The ESEC system consists of:

- Ⓐ **Power Board** (surface element control board mounted on the main back of the range)
- Ⓑ **User Interface Board or UIB** (circuit board mounted just below the control panel).
- Ⓒ **Four Potentiometers** (push-to-turn control for each element).
- Ⓓ **Display Boards** (separate assembly for left and right side consisting of two digital displays and ribbon connector).
- Ⓔ **ESEC Harness** - Connects the UIB, Power Board and EOC. The ESEC boards communicate with each other to control the elements and with the oven control for the lockout modes. (See photo at right.)
- Ⓕ **Remote Relay Board *** - Controls the outer ring of the Left Rear surface element.

* Remote Relay Board not found on all models.

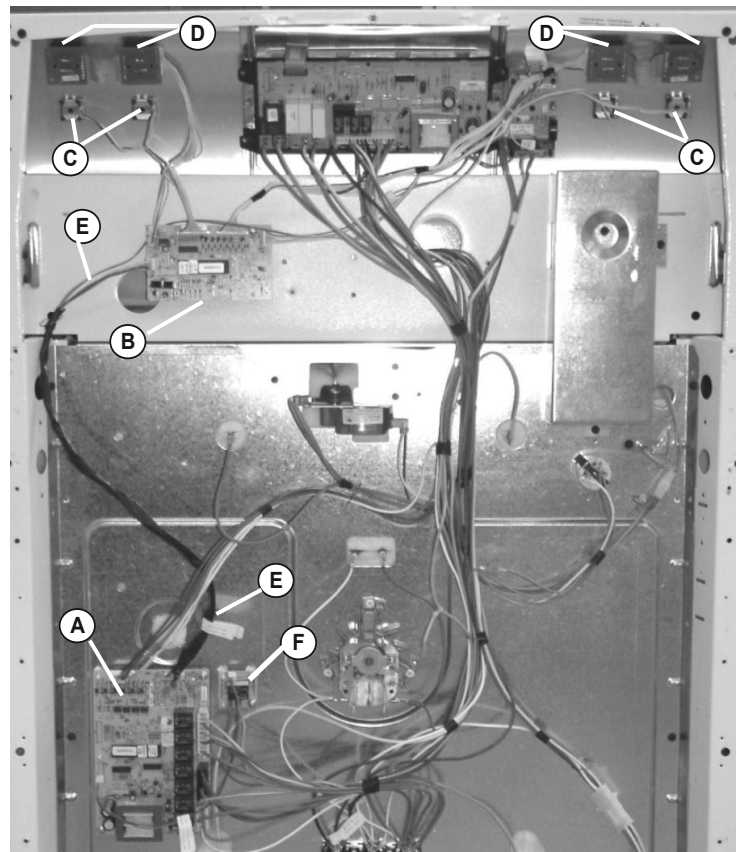

How The ESEC System Operates

When the user rotates the surface element control knob to the desired setting the User Interface Board (UIB) responds by displaying the selection on the ESEC display board and communicating the selection information to the power board. The power board then cycles the surface element on at the appropriate percentage to the power level selected. In addition the power board communicates to the Electronic Oven Control (EOC) that the surface element is in use so that the EOC will not be able to disable the surface elements via the cooktop lockout feature.

It is important to note that the surface element will cycle on and off at varying rates depending on the selected setting. The cycling of the element is more noticeable on a smoothtop range because the heating coil is visible through the glass cooktop.

When power is first applied the EOC will display a flashing “12:00” as well as the letters “PF”. The ESEC display boards will also display “PF” for a few seconds and then go blank (See Photo Below) .





On initial start-up or after a power outage the EOC performs a test of the ESEC system and oven temperature probe. This test will usually last about 15 seconds during which time the EOC can not be programmed and the surfaces elements can not be used. Attempting to use the surface elements during this time may result in an audible alarm and “ERR” displayed in the EOC .

If the ESEC system test and oven temperature probe test are good, the EOC will allow the time of day to be programmed and the oven and surface elements can be used.

Troubleshooting The ESEC System

Whenever a failure occurs in the ESEC system there will be a fault code displayed on the LED display boards on both sides of the control panel. Some examples are pictured below. For a complete list of possible ESEC fault codes see the chart provided on the following page.

<p>F5 00 - Communication break between EOC and UIB. Reset the power the range to see if fault code will clear. If code remains check the ESEC wiring harness and connectors. If these are good replace the UIB. If failure returns replace the EOC.</p>	
<p>F7 42 - Potentiometer for RF is wrong value. Test resistance value of potentiometer. If potentiometer has been replaced verify that the correct part number was used. Check for moisture contamination of potentiometer. If potentiometer is good and correct value replace the UIB.</p>	
<p>F7 40 - Potentiometer for RF is open. Test resistance value of potentiometer. Re-seat potentiometer harness connector. If potentiometer is good replace UIB.</p>	

ESEC Failure / Fault Codes

Displayed Fault Code	Description	Suggested Corrective Action
F5 A0	Bad EEPROM checksum.	<ol style="list-style-type: none"> 1. Reset power supply to range. 2. Replace Power Board.
F5 00	Communication break between EOC and UIB.	<ol style="list-style-type: none"> 1. Reset power supply to range. 2. Test ESEC wiring harness. Replace if defective 3. Replace UIB 4. Replace EOC
F5 01	Communication break between Power board & UIB	<ol style="list-style-type: none"> 1. Reset power supply to range. 2. Test ESEC wiring harness. Replace if defective 3. Replace UIB. 4. Replace Power Board
F5 02	UIB not communicating.	<ol style="list-style-type: none"> 1. Defective ESEC harness. Re-seat connectors. Test harness and replace if defective. 2. Defective UIB. Replace UIB 3. Defective Power Board. Replace Power Board
F5 F0	Watchdog timer timed out - Power Board.	<ol style="list-style-type: none"> 1. Reset power supply to range. 2. Replace Power Board.
F5 FF	Watchdog timer timed out - UIB.	<ol style="list-style-type: none"> 1. Reset power supply to range. 2. Replace UIB.
F7 10 F7 20 F7 30 F7 40	Potentiometer LF is open. Potentiometer LR is open. Potentiometer RR is open. Potentiometer RF is open.	<ol style="list-style-type: none"> 1. Defective potentiometer. Test and replace if defective. 2. Replace UIB.
F7 11 F7 21 F7 31 F7 41	Potentiometer LF is shorted. Potentiometer LR is shorted. Potentiometer RR is shorted. Potentiometer RF is shorted.	<ol style="list-style-type: none"> 1. Defective potentiometer. Test and replace if defective. 2. Replace UIB. 3. Check for moisture contamination in potentiometer.
F7 12 F7 22 F7 32 F7 42	Potentiometer for LF is wrong value. Potentiometer for LR is wrong value. Potentiometer for RR is wrong value. Potentiometer for RF is wrong value.	<ol style="list-style-type: none"> 1. Wrong value potentiometer installed. Verify correct part . 2. Defective potentiometer. Test and replace if defective. 3. Check for moisture contamination in potentiometer. 4. Replace UIB.

Servicing ESEC System Components

Potentiometers

There are two different potentiometers that are found on various ranges with the ESEC10R control system. These can be easily distinguished by the different colored housings. The Gray colored potentiometer is used to control single coil surface elements and the Black colored potentiometer is used on dual or “expandable” coil elements.

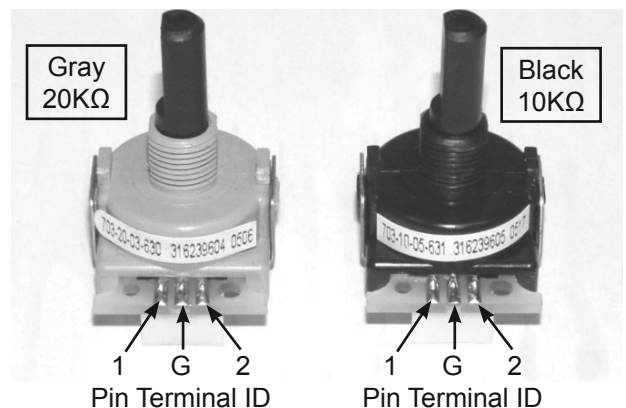

The photos below show the potentiometers and the display boards mounted to the range backguard panel. The potentiometers are held in place by a hex nut and lock washer. When replacing a potentiometer, do not over-tighten the hex nut. A torque of only 5 in.-lbs. is required to properly mount the potentiometer. Over-tightening the hex nut will negatively affect the smooth feel of the knob turn and can damage the potentiometer.

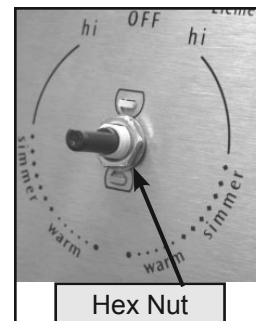
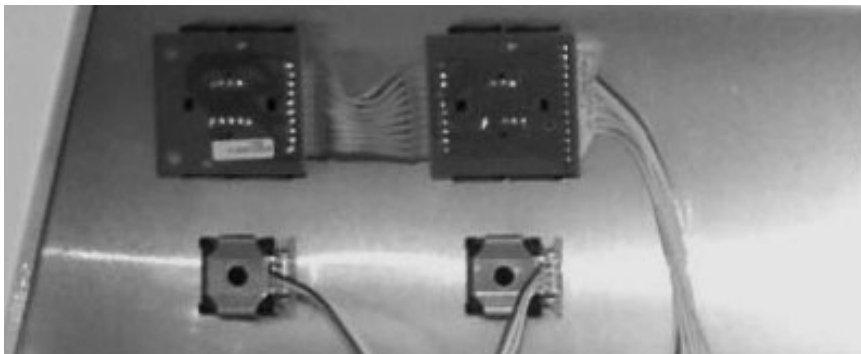

To test the resistance value of either potentiometer make sure that the shaft is set to the off position, disconnect the wire harness and use an ohm meter to measure the resistance between pins 1 & 2 on the potentiometer. The gray potentiometer should have a resistance of 20KΩ (± 10%) and the black potentiometer should have a resistance of 10KΩ (± 10%).

To test operation of the potentiometer measure the resistance between Pin terminal G (center) and either of the outside pin terminals as the control shaft is being rotated slowly. There should be a steady increase or decrease in the measured resistance as the shaft is turned.

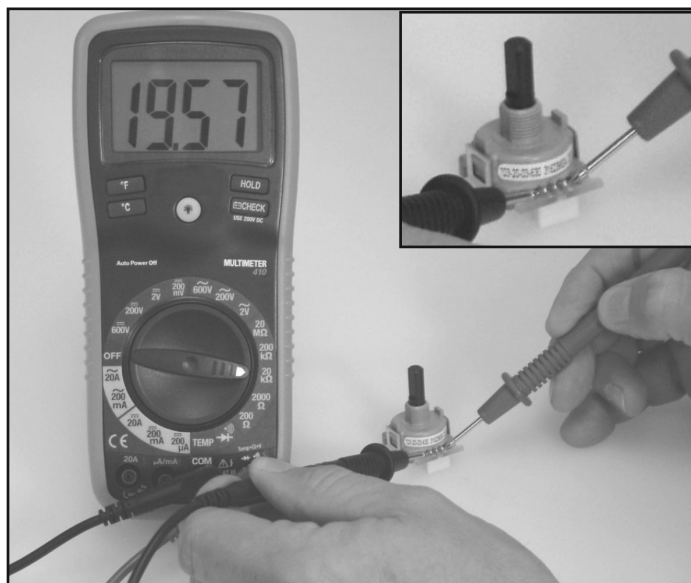

Each potentiometer has positive detents or “stops” that can be felt as the shaft is rotated. The drawings below illustrate the stop positions for the different potentiometers.

The Potentiometer Resistance Table gives the various resistance readings that should be found at each of the stop positions. Resistance values are approximate and may vary by ±10%.

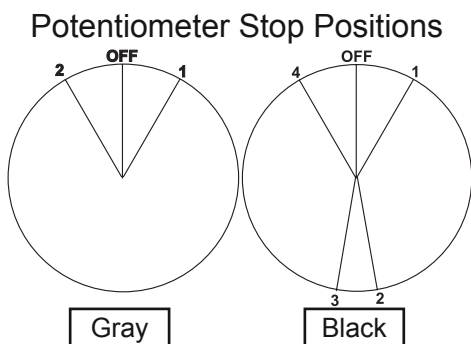

Potentiometer Resistance Table			
Stop Position	Pin Terminals	Gray POT	Black POT
Off	1 - 2	20 KΩ	10 KΩ
1	1 - G	1 KΩ	500 Ω
	2 - G	19 KΩ	9.5 KΩ
2	1 - G	19 KΩ	4.5 KΩ
	2 - G	1 KΩ	5.5 KΩ
3	1 - G	N/A	5.5 KΩ
	2 - G	N/A	4.5 KΩ
4	1 - G	N/A	9.5 KΩ
	2 - G	N/A	500 Ω

Display Boards

The display boards are secured to the control panel by the display lenses. The lens is inserted into the panel from the front and the display board locks onto the lens from behind. The following instructions explain how to separate the board from the lens and remove the lens from the control panel without damage.

The board is secured to the lens by two locking tabs (Photo 1) .

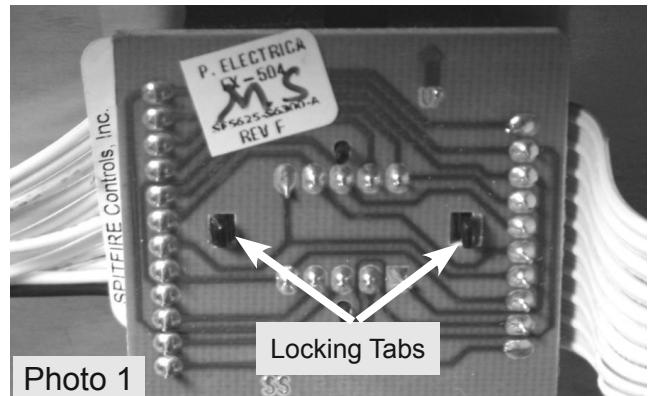
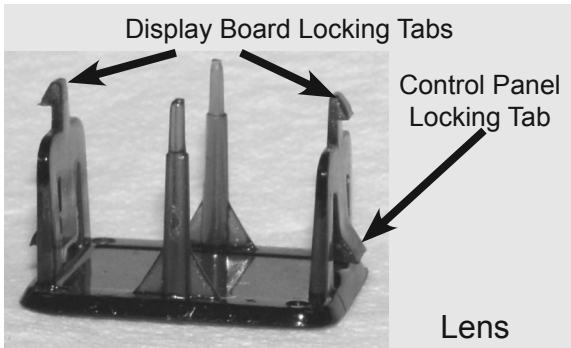

Using a non metallic object such as a pen or your fingertip, **gently** depress the locking tab pushing from the outside toward the center of the board (Photo 2).

Pull the bottom of the board slightly while you are depressing the tab to release the board. Repeat for each side of the board.

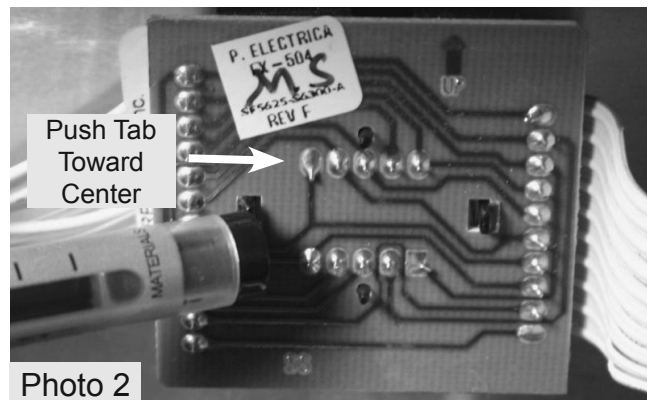

The board is now free from the lens and may be replaced (Photo 3).

The display boards are assembled as pairs. Both boards must be removed for service.

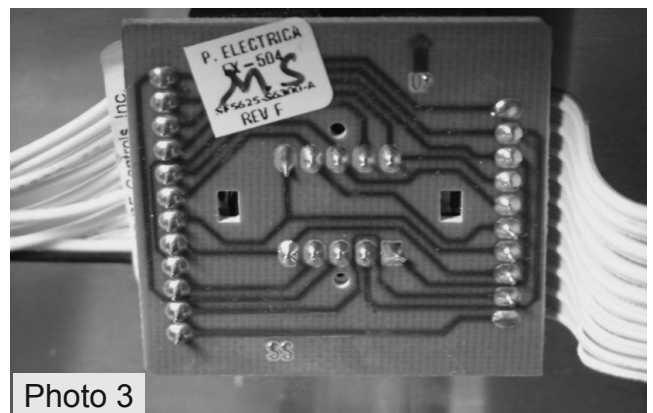

To remove the lens from the control panel push inward on the panel locking tabs on each side of the lens. The lens will disengage from the panel and it can be removed. See Photo 4.

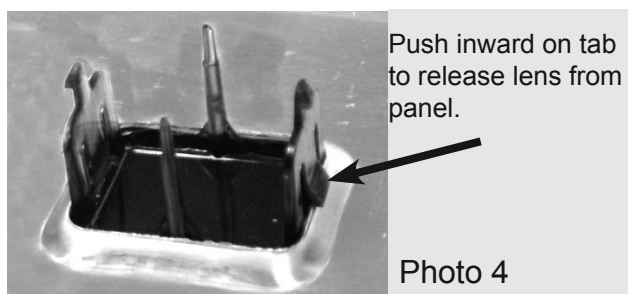

User Interface Board

The UIB is mounted to the rear chassis of the range just below the control panel backguard. Prior to removing the UIB unplug the wire harness connectors to the display boards and power board.

DO NOT ATTEMPT TO UNPLUG THE HARNESS CONNECTORS TO THE POTENTIOMETERS.

These connectors and harness wires are part of the UIB. Unplug the harness connectors at the potentiometers to replace the UIB.

The UIB is secured to the range with one mounting screw and two snap-lock spacers. There is an additional tubular spacer used to maintain proper distance between the circuit board and range chassis. When replacing the UIB these spacers and screw must be reused. When replacing the UIB do not over-tighten the screw. A torque of only 10 in.-lbs. is required to tighten the screws. Over-tightening the screws can damage the plastic standoffs and possibly the board itself.

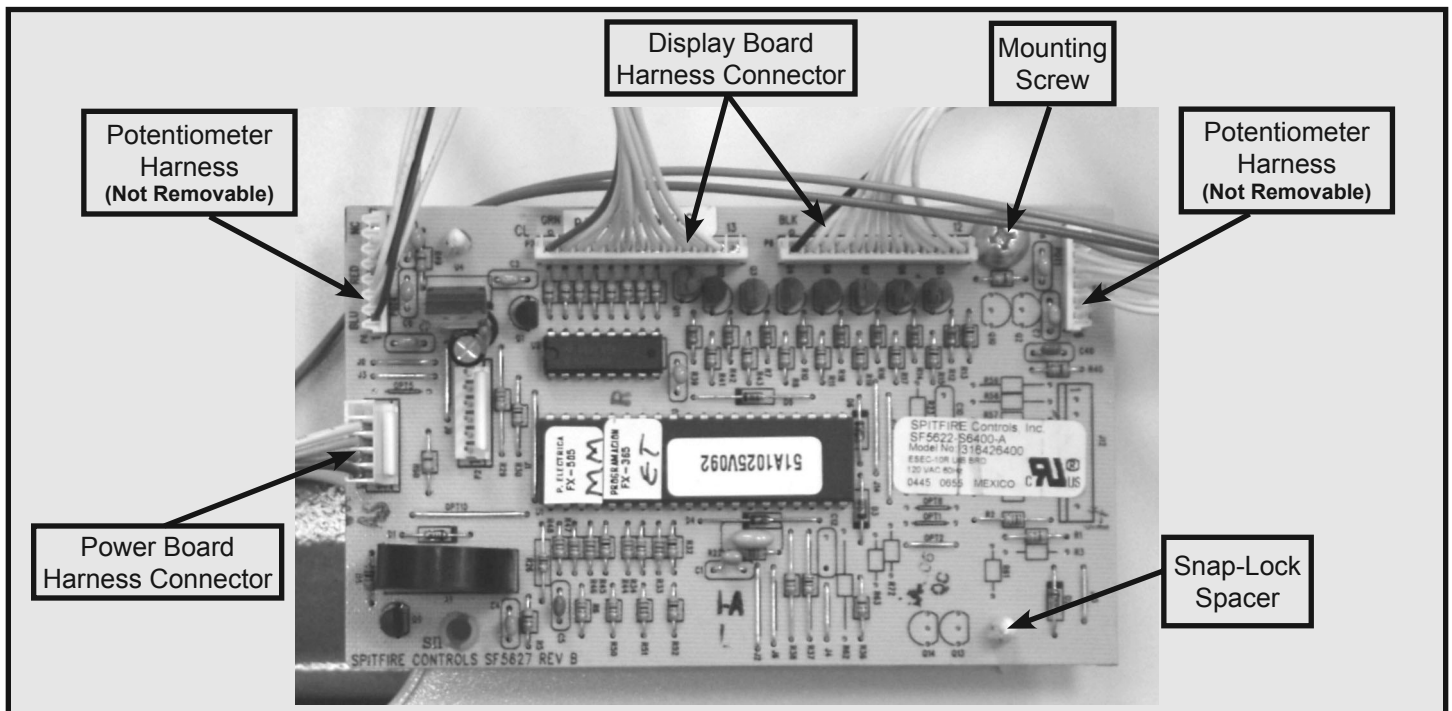

Troubleshooting The Power Board

The power board controls the cycling of the cooktop surface elements by supplying the L2 side of the power supply to the element. The L1 side of the power supply is connected to terminal 2a on the element terminal block.

When the user turns the potentiometer to the desired setting the UIB communicates this information to the power board. The power board then closes the appropriate relays to send L2 voltage to the element. The power board will cycle the element relay on and off at varying rates relative to the chosen setting on the potentiometer.

If the ESEC system appears to be working properly but the power board fails to send voltage to the selected element then the relay on the power board may be burned out, stuck open, or the power board may be defective.

If the surface element continues to heat when the controls are turned off (runaway condition) and the display boards are blank then the relay for that element is stuck closed. Whenever any of these conditions are encountered the power board must be replaced.

The photo below shows an ESEC Power Board and Remote Relay Board as they appear when installed on a range. When replacing the Power Board or Remote Relay Board do not over-tighten the screws. A torque of only 10 in.-lbs. is required to tighten the screws. Over-tightening the screws can damage the plastic standoffs and possibly the board itself.

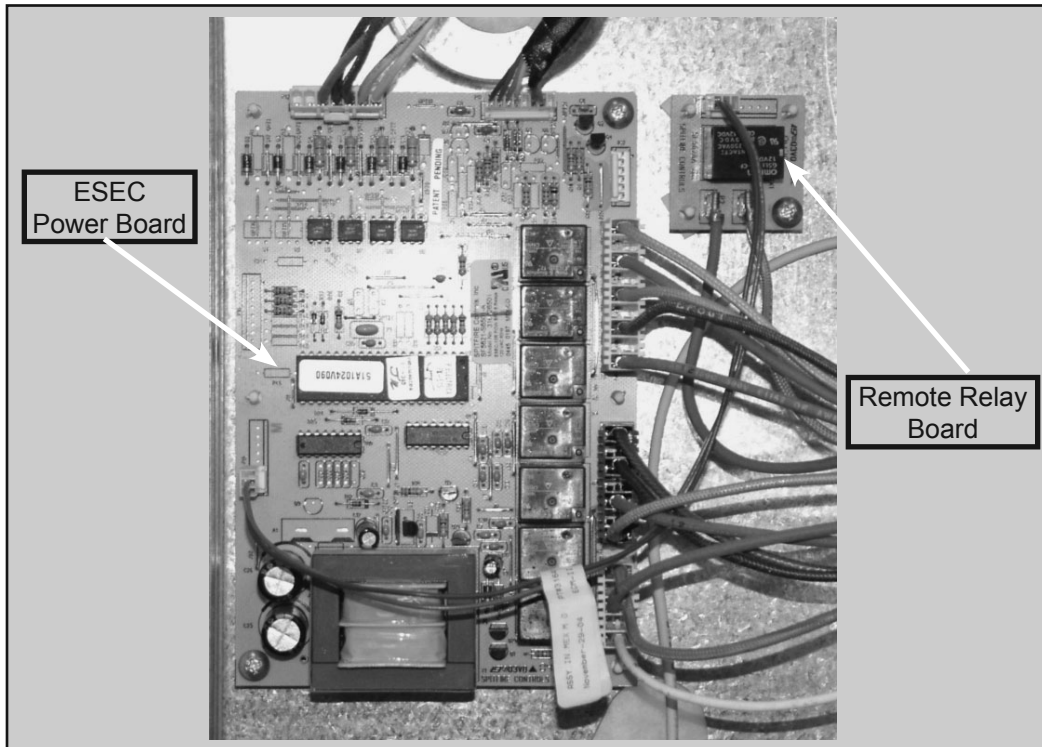

Remote Relay Board

On ESEC models which have a cooktop with four Dual Element Surface burners there is additional remote Remote Relay Board mounted adjacent to the power board. This board controls the outer ring of the left rear dual surface element.

If the Remote Relay Board fails to send power to the outer ring of the left rear element the failure could be caused by a defective Remote Relay Board, faulty wiring harness, or defective Power Board. The relay may be burned out, stuck open, or the relay board could be defective.

Test the harness between the ESEC power board (P15) and the Remote Relay Board (P1). If the harness is good replace the Remote Relay Board.

The circuit diagrams on the facing page show examples of each type of ESEC system. Diagram A shows an ESEC system without the Remote Relay Board. Diagram B shows an ESEC system with the Remote Relay Board.

