

# **KitchenAid**

TECHNICAL EDUCATION

## **briva™ IN-SINK DISHWASHER**



Model KIDS01EK

## FORWARD

This KitchenAid Job Aid, “briva® In-Sink Dishwasher,” (Part No. 4317308), provides the technician with information on the installation, operation, and service of the briva® In-Sink Dishwasher. It is to be used as a training Job Aid and Service Manual. For specific information on the model being serviced, refer to the “Use and Care Guide,” or “Tech Sheet” provided with the dishwasher.

The Wiring Diagram and Strip Circuits used in this Job Aid are typical and should be used for training purposes only. Always use the Wiring Diagram supplied with the product when servicing the unit.

## GOALS AND OBJECTIVES

The goal of this Job Aid is to provide detailed information that will enable the service technician to properly diagnose malfunctions and repair the KitchenAid briva® In-Sink Dishwasher.

The objectives of this Job Aid are to:

- Understand and follow proper safety precautions.
- Successfully troubleshoot and diagnose malfunctions.
- Successfully perform necessary repairs.
- Successfully return the dishwasher to its proper operational status.

WHIRLPOOL CORPORATION assumes no responsibility for any repairs made on our products by anyone other than Authorized Service Technicians.

# TABLE OF CONTENTS

	Page
<b>GENERAL</b> .....	1-1
Safety First.....	1-1
KitchenAid In-Sink Dishwasher Model & Serial Number Designations.....	1-3
KitchenAid In-Sink Dishwasher Model & Serial Number Label And Tech Sheet Locations.....	1-4
KitchenAid Hot Water Booster Tank Model & Serial Number Designations.....	1-5
KitchenAid Hot Water Booster Tank Model & Serial Number Location.....	1-6
In-Sink Dishwasher Specifications.....	1-7
KitchenAid Dishwasher Warranty.....	1-8
KitchenAid Hot Water Booster Tank Warranty.....	1-9
<b>INSTALLATION INFORMATION</b> .....	2-1
Dishwasher.....	2-1
General.....	2-1
Product Dimensions.....	2-2
Cabinet Dimensions.....	2-3
Electrical Supply Requirements.....	2-4
Water And Drain Requirements.....	2-5
Installing The Dishwasher.....	2-6
Hot Water Booster Tank.....	2-9
Product Dimensions.....	2-9
General.....	2-10
Electrical Supply Requirements.....	2-12
Installing The Hot Water Tank.....	2-13
<b>PRODUCT OPERATION</b> .....	3-1
Ground Fault Circuit Interrupter (GFCI).....	3-1
Pressure Switch.....	3-1
Lid Latch.....	3-2
Inline Water Heater.....	3-2
Optional Auxiliary Water Heater.....	3-2
Cycle Selection Charts.....	3-3
Changing A Cycle Or Setting.....	3-4
Adding Items During A Cycle.....	3-4
Option Selections.....	3-5
Cycle Status Indicators.....	3-6
briva Wash System.....	3-7
Drying System.....	3-7
Hot Water Tank Operation.....	3-8

	<b>Page</b>
<b>COMPONENT ACCESS</b> .....	4-1
Component Locations .....	4-1
Removing The Spray Arm .....	4-2
Removing The Poppet .....	4-3
Removing The Drain And Fill Air Gaps .....	4-5
Removing The Dispenser Level Switch And The Rinse Agent Solenoid .....	4-6
Removing The User Interface, The Interlock Switch, Latch Assembly, And Wax Motor .....	4-8
Removing The Ground Fault Circuit Interrupter, Electronic Control Board, And Thermal Cutout .....	4-11
Removing The Water Inlet Valve .....	4-13
Removing The Thermistor .....	4-14
Removing The Drain Pump .....	4-15
Removing The Wash Pump Motor And Inline Heater .....	4-16
Removing The Sump .....	4-18
Removing The Pressure Switch .....	4-20
Removing The Wash Pump Motor Capacitor .....	4-21
Removing The Dishwasher Lid And The Linkage Components .....	4-22
Removing The Dishwasher Lid Actuator .....	4-25
<b>COMPONENT TESTING</b> .....	5-1
Dispenser Level Switch .....	5-1
Rinse Agent Solenoid .....	5-2
Interlock Switch .....	5-2
Wax Motor .....	5-3
Water Inlet Valve Solenoid .....	5-3
Thermistor .....	5-4
Drain Pump .....	5-4
Wash Pump Motor .....	5-5
Inline Heater .....	5-5
Pressure Switch .....	5-6
Wash Pump Motor Capacitor .....	5-6
<b>DIAGNOSIS &amp; TROUBLESHOOTING</b> .....	6-1
Diagnostics Cycle Time Chart .....	6-1
Checking The Keypad And Keyswitch Operation .....	6-3
Normal Cycle Operation Chart .....	6-4
Troubleshooting Chart .....	6-5
<b>WIRING DIAGRAM &amp; STRIP CIRCUITS</b> .....	7-1
Schematic Diagram .....	7-1
Strip Circuits .....	7-2

# GENERAL SAFETY FIRST

**Your safety and the safety of others is very important.**

We have provided many important safety messages in this Job Aid and on the appliance. Always read and obey all safety messages.



This is the safety alert symbol.

This symbol alerts you to hazards that can kill or hurt you and others. All safety messages will follow the safety alert symbol and either the word "DANGER" or "WARNING." These words mean:

**! DANGER**

**You can be killed or seriously injured if you don't immediately follow instructions.**

**! WARNING**

**You can be killed or seriously injured if you don't follow instructions.**

All safety messages will tell you what the potential hazard is, tell you how to reduce the chance of injury, and tell you what can happen if the instructions are not followed.

**! WARNING**



**Electrical Shock Hazard**

**Disconnect power before servicing.**

**Replace all parts and panels before operating.**

**Failure to do so can result in death or electrical shock.**

**! WARNING**



**Electrical Shock Hazard**

**Plug into a grounded 3-prong outlet.**

**Do not remove ground prong.**

**Do not use an adapter.**

**Do not use an extension cord.**

**Failure to follow these instructions can result in death, fire, or electrical shock.**

**! WARNING**

**Excessive Weight Hazard**

**Use two or more people to move and install dishwasher.**

**Failure to do so can result in back or other injury.**

### **Precautions To Be Observed Before And During Servicing Of Dishwasher**

- A. There is line voltage present at several points in the console and below the tub. Be sure to always disconnect the power supply at the fuse or breaker box before replacing a component.
- B. Always check the wiring harness and connectors before performing any test procedures.
- C. Disconnect the power supply before touching the circuit board, or reseating electronic control board connectors.
- D. Resistance checks are made on components with the wiring harness disconnected.

### **IMPORTANT Electrostatic Discharge (ESD) Sensitive Electronics**

**ESD problems are present everywhere. ESD may damage or weaken the electronic control assembly. The new control assembly may appear to work well after repair is finished, but failure may occur at a later date due to ESD stress.**

- Use an antistatic wrist strap. Connect the wrist strap to the green ground connection point, or to an unpainted metal surface in the appliance.

**- OR -**

- Touch your finger repeatedly to a green ground connection point, or to an unpainted metal surface in the appliance.
- Before removing the part from its package, touch the antistatic bag to a green ground connection point, or to an unpainted metal surface in the appliance.
- Avoid touching electronic parts, or terminal contacts. Handle the electronic control assembly by the edges only.
- When repackaging the failed electronic control assembly in an antistatic bag, observe the previous instructions.

# KITCHENAID IN-SINK DISHWASHER MODEL & SERIAL NUMBER DESIGNATIONS

## MODEL NUMBER

<b>MODEL NUMBER</b>	<b>K</b>	<b>I</b>	<b>D</b>	<b>S</b>	<b>01</b>	<b>E</b>	<b>K</b>	<b>SS</b>	<b>0</b>
<b>PRODUCT GROUP</b> K = KITCHENAID BRAND									
<b>PRODUCT IDENTIFICATION</b> I = IN-SINK									
<b>PRODUCT TYPE</b> D = DISHWASHER									
<b>FEATURE CODE</b> S = SUPERIOR									
<b>SERIES</b>									
<b>STYLE</b>									
<b>YEAR OF INTRODUCTION</b> K = 2001									
<b>COLOR CODE</b> SS = STAINLESS STEEL									
<b>ENGINEERING CHANGE (NUMERIC)</b>									

## SERIAL NUMBER

<b>SERIAL NUMBER</b>	<b>F</b>	<b>P</b>	<b>10</b>	<b>11181</b>
<b>MANUFACTURING SITE</b> F = FINDLAY, OH				
<b>YEAR OF PRODUCTION</b> M = 2002, P = 2003				
<b>WEEK OF PRODUCTION</b> 10 = 10th WEEK				
<b>PRODUCT SEQUENCE NUMBER</b>				

# KITCHENAID IN-SINK DISHWASHER MODEL & SERIAL NUMBER LABEL AND TECH SHEET LOCATIONS

The Model/Serial Number Label and Tech Sheet locations are shown below.





# KITCHENAID HOT WATER BOOSTER TANK MODEL & SERIAL NUMBER DESIGNATIONS

## MODEL NUMBER

<b>MODEL NUMBER</b>	<b>K</b>	<b>WH</b>	<b>02</b>
<b>PRODUCT GROUP</b> K = KITCHENAID BRAND			
<b>WATER HEATER</b>			
<b>CAPACITY</b> 02 = 2.5 GALLONS			

## SERIAL NUMBER

<b>SERIAL NUMBER</b>	<b>FT</b>	<b>N</b>	<b>04</b>	<b>10019</b>
<b>TRU-HEAT</b>				
<b>YEAR OF PRODUCTION</b> N = 2003				
<b>WEEK OF PRODUCTION</b> 04 = 4TH WEEK				
<b>PRODUCT SEQUENCE NUMBER</b>				

# KITCHENAID HOT WATER BOOSTER TANK MODEL & SERIAL NUMBER LOCATION



Model/Serial Number Label

# IN-SINK DISHWASHER SPECIFICATIONS

## **Electrical:**

Electrical Supply (Under Load) ..... 120 VAC, 60 Hz  
Amperage ..... 10 amperes  
Ground Fault Circuit Interrupter (GFCI) ..... Test and Reset Buttons

## **General:**

Wash Pump Motor ..... 200 Watt  
Drain Pump Motor ..... 25 Watt  
Pressure Switch ..... Two Position, Fill and Overflow  
Water Level In Tank ..... 1/2"  
Inline Water Heater ..... 1000 Watt  
Supply Water Flow Rate To Fill ..... 1.9 liters (2 quarts) in 27 seconds  
Supply Water Pressure ..... 120 psi maximum, 20 psi minimum  
Supply Water Temperature ..... 49°C (120°F)  
(Before starting a cycle, run water from sink faucet until hot.)  
Water Charge ..... 3.5 liters (0.9 gallons) / first fill (approximate)  
3.0 liters (0.8 gallons) / all other fills  
Spray Arm Rotation ..... 18 to 35 rpm  
Dish Rack (1) ..... Tiered w/Glass Rack  
Air Gap (2) ..... Fill and Drain

## **Dimensions:**

Length ..... 22"  
Width ..... 40-1/2"  
Depth (DW) ..... 14-1/4"  
Depth (Sink) ..... 8-1/8"  
Weight ..... 75 lbs.

## **Optional:**

Auxiliary Water Heater ..... 1100 Watts, 2-1/2 gallons

## **Vinyl Touch-Up Kit:**

- 676455 - Gray

# KITCHENAID DISHWASHER WARRANTY

LENGTH OF WARRANTY	KITCHENAID WILL PAY FOR:
<b>FULL ONE YEAR WARRANTY</b> From Date of Purchase	Replacement parts and repair labor to correct defects in materials or workmanship. Service must be provided by a KitchenAid designated service company.
<b>LIMITED WARRANTY</b> 2nd through 5th Year	Replacement parts for the following components if defective in materials or workmanship: the upper and lower nylon racks, the wash and drain motor, and the electronic controls.
<b>LIFETIME WARRANTY</b>	Replacement parts and repair labor for the stainless steel tub and/or inner door if the tub and/or inner door develops a water leak caused by rust-through resulting from defective materials or workmanship. Service must be provided by a KitchenAid designated service company.
<b>KITCHENAID WILL NOT PAY FOR:</b> <ul style="list-style-type: none"> <li>A. Service calls to:                             <ul style="list-style-type: none"> <li>1. Correct the installation of the dishwasher.</li> <li>2. Instruct you how to use the dishwasher.</li> <li>3. Replace house fuses or correct house wiring or plumbing</li> </ul> </li> <li>B. Repairs when dishwasher is used in other than normal, single family household use.</li> <li>C. Damage resulting from accident, alteration, misuse, abuse, fire, floods, acts of God, improper installation, or installation not in accordance with local electrical and plumbing codes, or the use of products not approved by KitchenAid.</li> <li>D. Pickup and delivery. Your dishwasher is designed to be repaired in the home.</li> <li>E. Any labor costs during the limited warranty period.</li> <li>F. Replacement parts or repair labor costs for units operated outside the United States.</li> <li>G. Repairs to parts or systems caused by unauthorized modifications made to the appliance.</li> </ul>	

**KITCHENAID DOES NOT ASSUME ANY RESPONSIBILITY FOR INCIDENTAL OR CONSEQUENTIAL DAMAGES.**

Some states do not allow the exclusion or limitation of incidental or consequential damages, so this exclusion or limitation may not apply to you. This warranty gives you specific legal rights and you may also have other rights which may vary from state to state.

**Outside the 50 United States, this warranty does not apply. Contact your authorized KitchenAid dealer to determine if another warranty applies.**

If you need service, first see the "Troubleshooting" section in the Use and Care Guide. Additional help can be found by checking the "Assistance or Service" section, or by calling our Customer Interaction Center at: **1-800-422-1230**, from anywhere in the U.S.A. or write: KitchenAid Brand Home Appliances, Customer Interaction Center, 553 Benson Road, Benton Harbor, MI. 49022-2692.

# KITCHENAID HOT WATER BOOSTER TANK WARRANTY

<b>LENGTH OF WARRANTY</b>	<b>KITCHENAID WILL PAY FOR:</b>
<b>FULL ONE YEAR WARRANTY</b> From Date of Purchase	For one year from the date of purchase, when this appliance is operated and maintained according to the instructions attached to or furnished with the product, KitchenAid will pay for labor and replacement if your hot water accessory tank is defective in materials or workmanship. Service must be provided by a KitchenAid designated service company.  This product is not designed to be serviced in the home.
<b>KITCHENAID WILL NOT PAY FOR:</b> <ul style="list-style-type: none"> <li>A. Service calls to:           <ul style="list-style-type: none"> <li>1. Correct the installation of the hot water booster tank.</li> <li>2. Instruct you how to use the hot water booster tank.</li> <li>3. Replace house fuses or correct house wiring.</li> </ul> </li> <li>B. Repairs when hot water booster tank is used in other than normal, single-family household use.</li> <li>C. Damage to hot water booster tank caused by accident, alteration, improper installation, misuse, fire, flood, acts of God or use of products not approved by KitchenAid.</li> <li>D. Repairs to parts or systems resulting from unauthorized modifications made to the appliance.</li> <li>E. Replacement parts or repair labor costs for units operating outside the United States.</li> </ul>	

**KITCHENAID SHALL NOT BE LIABLE FOR INCIDENTAL OR CONSEQUENTIAL DAMAGES.** Some states do not allow the exclusion or limitation of incidental or consequential damages, so this exclusion or limitation may not apply to you.

**This warranty gives you specific legal rights, and you may also have other rights which may vary from state to state.**

**Outside the United States this warranty does not apply. Contact your authorized KitchenAid dealer to determine if another warranty applies.**

If you need service, additional help can be found by checking the "Requesting Assistance or Service" section or by calling our KitchenAid Customer Interaction Center, **1-800-422-1230** (toll-free), from anywhere in the U.S.A.

— NOTES —

# INSTALLATION INFORMATION

## DISHWASHER

### General

**IMPORTANT: Observe all governing codes and ordinances.**

Proper installation is your responsibility:

- Contact a qualified installer.
- Installation must be performed by a qualified service technician. The dishwasher must be installed to all electrical and plumbing national and local codes and ordinances.
- Install the dishwasher as specified in these instructions.
- Have everything you need to properly install dishwasher.

**Protect dishwasher and water lines leading to dishwasher against freezing. Damage from freezing is not covered by the warranty.**

The dishwasher is shipped ready for installation of a one-hole faucet. If a two-, three-, or four-hole faucet is to be installed, the holes must be added by a qualified plumber according to the faucet manufacturer's specifications.

### TOOLS AND MATERIAL REQUIRED

- Gloves
- Safety glasses
- 5/8" open-end wrench (for water fill line connection)
- 3/8" deepwell socket (for undercounter clamp brackets)
- 3/8" copper tubing with compression fitting water fill line. The length needed is determined by specific installation requirements.

- Copper tubing with compression fittings (for faucet connection). The length and diameter needed are determined by specific faucet installation requirements.
- Small tubing cutter
- Faucet
- Two 1-1/2" drain traps
- 3-1/2" sink strainer
- Plumber's putty
- Sink strainer locknut wrench
- 10" adjustable wrench that opens to 1-1/8" (for 90° elbow)
- 90° elbow with 3/8" N.P.T. external threads on one end (the other end must fit your water supply line)
- Teflon™ tape, or pipe joint compound
- One cartridge of silicone caulk and a caulk gun

If you are using direct wiring, you will need:

- Two twist-on connectors of the proper size to connect the house wiring to the 16-gauge dishwasher wiring
- U.L.-listed cable clamp or conduit connector to fit a 7/8" inch hole

### PARTS SUPPLIED

- Undercounter clamp brackets
- Cutting board

# Product Dimensions

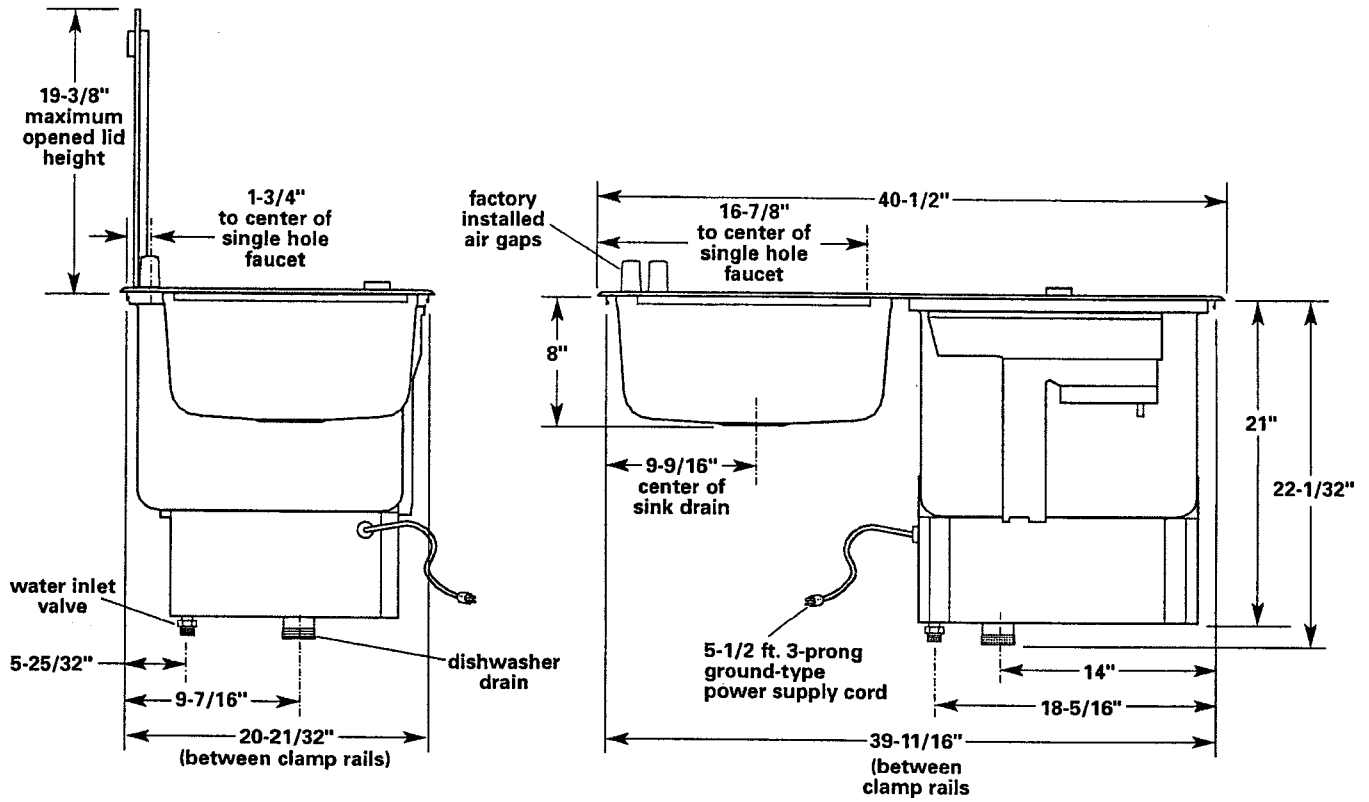



# Cabinet Dimensions

\* Note: The cutout must be accurately cut to the dimensions shown. The dishwasher top flange overlaps the countertop cutout by 1/4" on the front and back edges, and 3/8" on the sides.

\*\* Note: The undercounter clamp brackets shipped with the dishwasher are designed for countertops up to 3/4" thick. If the countertop is more than 3/4" thick, the areas where the clamp brackets will be installed **MUST** be routed to a maximum thickness of 3/4".

CRITICAL RADIUS dimensions	
Corner radius dimensions specified <b>MUST</b> be used. If they are not, the dishwasher will <b>NOT</b> fit the opening.	
<b>A</b>	radius: 2-1/4"
<b>B</b>	radius: 1"
<b>C</b>	Back corners: If countertop is more than 3/4" thick, measure down 3/4" and cut 45° bevel around radius.

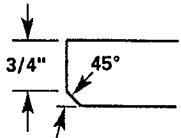
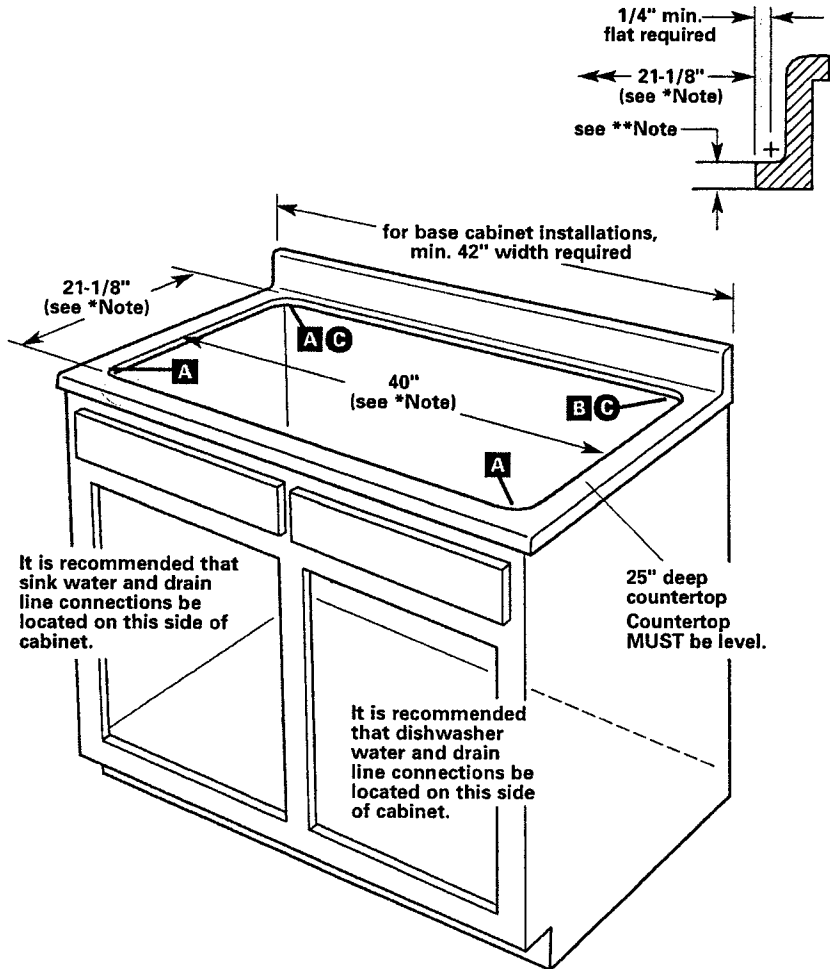
# Electrical Supply Requirements

## ⚠ WARNING



### Electrical Shock Hazard

**Plug into a grounded 3-prong outlet.**

**Do not remove ground prong.**

**Do not use an adapter.**

**Do not use an extension cord.**

**Failure to follow these instructions can result in death, fire, or electrical shock.**

If codes permit and a separate ground wire is used, it is recommended that a qualified electrician determine that the ground path is adequate.

**Do not** ground to a gas pipe.

Check with a qualified electrician if you are not sure the dishwasher is properly grounded.

**Do not** have a fuse in the neutral or ground circuit.

A 120-volt, 60-Hz, AC-only, 15- or 20-ampere fused electrical supply is required. (Time-delay fuse or circuit breaker is recommended.) It is recommended that a separate circuit serving only this appliance be provided.

## RECOMMENDED GROUNDING METHOD

For your personal safety, this appliance must be grounded. This appliance is equipped with a power supply cord having a 3-prong ground plug. To minimize possible shock hazard, the cord must be plugged into a mating 3-prong ground-type outlet, grounded in accordance with local codes and ordinances (see below). If a mating outlet is not available, it is the personal responsibility and obligation of the customer to have a properly grounded 3-prong outlet installed by a qualified electrician.

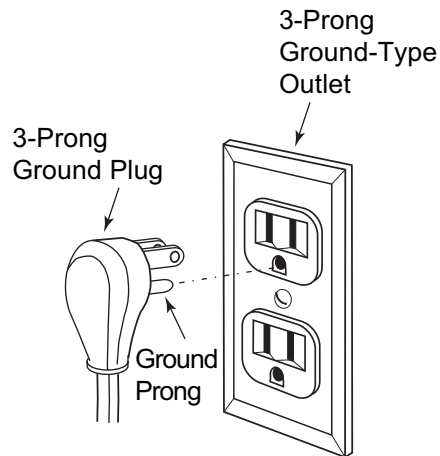

### If the dishwasher must be direct wired:

- Use flexible, armored or nonmetallic sheathed, copper wire with grounding wire that meets the wiring requirements for the home, and local codes and ordinances.
- Use a U.L.-listed conduit connector, or if using nonmetallic sheathed, copper wire, a U.L.-listed cable clamp connector.

# Water And Drain Requirements

## DISHWASHER

- A hot water line with 20-120 psi water pressure.
- 120°F water at dishwasher.
- 3/8" O.D. copper tubing with compression fittings, or flexible stainless steel braided fill line (1/2" minimum plastic tubing is optional but not recommended).
- A 90° elbow with 3/8" N.P.T. external pipe threads on one end.

**Important:** Do not solder within 6" from the water inlet valve.

## SINK FAUCET

- A hot and cold water line.
- Copper tubing with compression fittings for the specific faucet to be installed.

## DRAINS

Separate drain traps for the sink and dishwasher must be provided.

If the dishwasher drain exits through the back wall, the center line of the drain MUST be a minimum of 1/2" below the dishwasher drain. This is required to completely drain the dishwasher tub so that no standing water remains in tub.

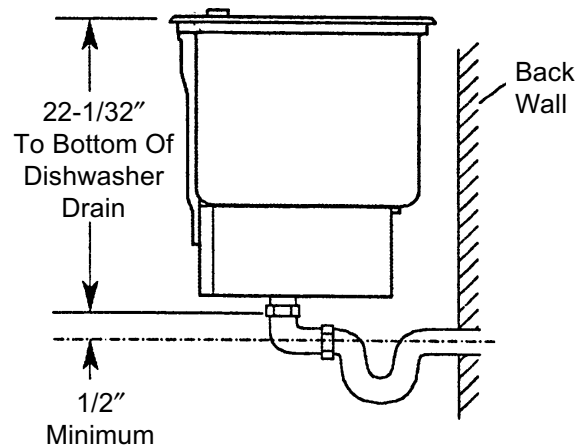

# Installing The Dishwasher

## ⚠ WARNING

### Excessive Weight Hazard

Use two or more people to move and install dishwasher.

Failure to do so can result in back or other injury.

## DIRECT WIRE METHOD

If the dishwasher must be directly wired to meet local codes, the power supply cord must be removed, and the dishwasher wired directly. Electrical connections must be contained within the terminal box, and meet all national and local codes and ordinances.

IF THE POWER SUPPLY CORD IS REMOVED, THE DISHWASHER MUST BE CONNECTED WITH COPPER WIRE ONLY.

Route the direct wire so that it does not touch the lower part of the dishwasher tub.

If you are not using the "Direct Wire Method," proceed to "Mounting The Dishwasher" on page 2-8.

## ⚠ WARNING



### Electrical Shock Hazard

Disconnect electrical power at the fuse box or circuit breaker box before installing dishwasher.

Failure to do so can result in death or electrical shock.

1. Lay the dishwasher on its back.
2. Remove the two screws from each side of the front panel, and the one screw above the ground fault circuit interrupter (GFCI), and remove the front panel.

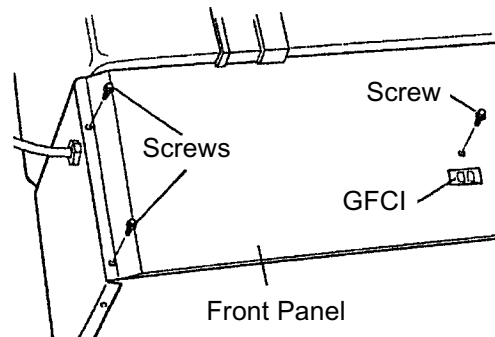

3. Remove the terminal box screw and remove the terminal box.

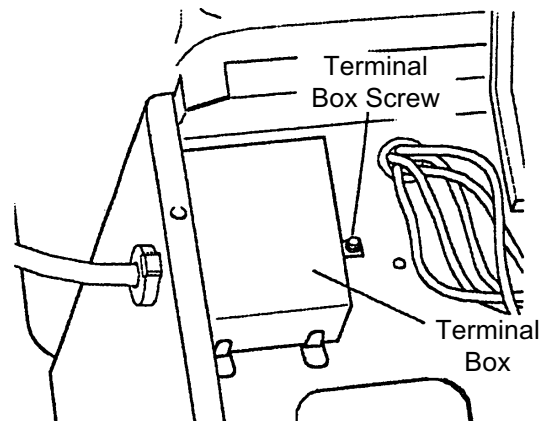

4. Remove the power cord green ground wire from under the green ground screw.
5. Remove the twist-on connectors and disconnect the black and white wires.

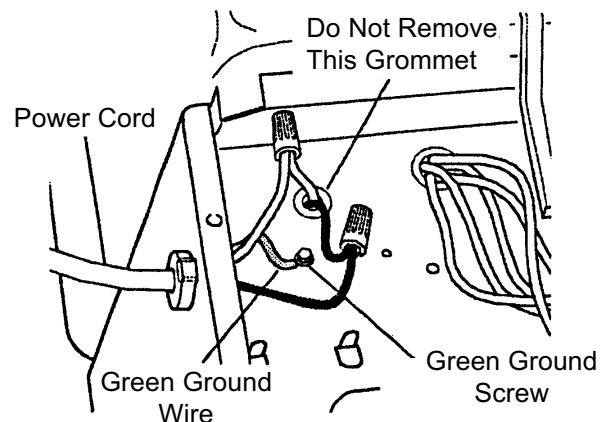

6. Use a pair of pliers and squeeze the locking tab in the power cord strain relief grommet, then pull the strain relief and power cord out of the mounting hole.

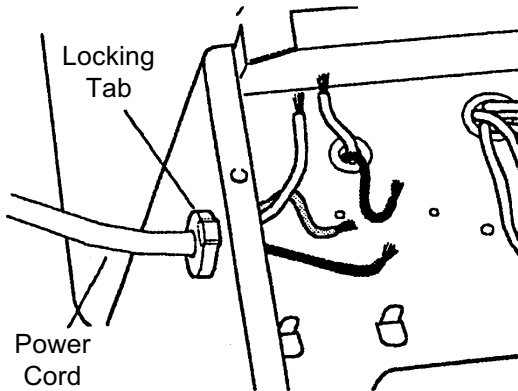

7. Install a U.L.-listed cable clamp or conduit connector in the power cord hole.

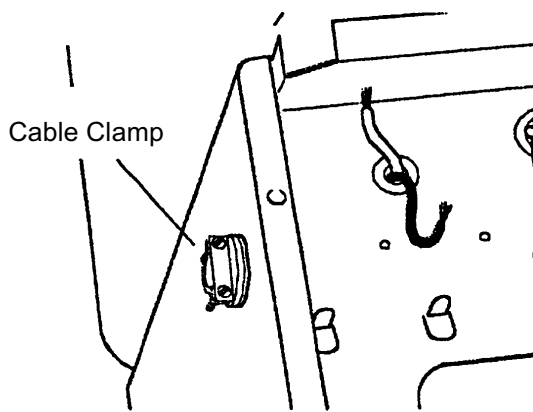

8. Pull the direct wire through the cable clamp or conduit connector, and connect the wires as follows:

- Form the ground wire into a hook.
- Wrap the hooked end around the ground screw and below the washer in the direction shown below, and tighten ground screw securely.
- Use twist-on connectors of the proper size, and connect the direct wire to the 16-gauge dishwasher wiring. Be sure to connect the black wires together, and the white wires together.
- Tighten the cable clamp or conduit connector screws.

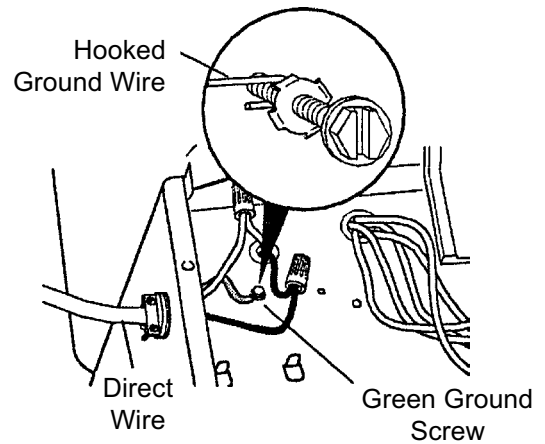

9. Reinstall the terminal box. **Important:** The tabs **MUST** be under the terminal box as shown.

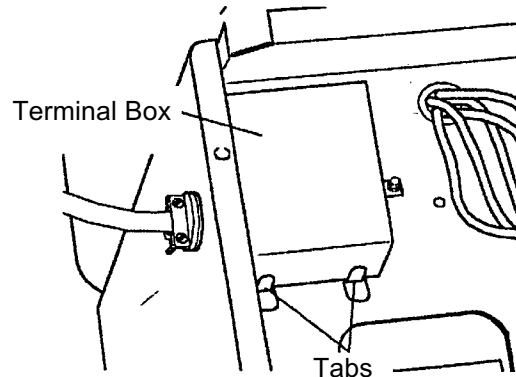

## ⚠ WARNING



**Electrical Shock Hazard**  
**Electrically ground dishwasher.**  
**Connect ground wire to green ground connector in terminal box.**  
**Do not use an extension cord.**  
**Failure to do so can result in death, fire, or electrical shock.**

## MOUNTING THE DISHWASHER

1. Install the faucet (not included). The dishwasher is shipped ready for installation of a one-hole faucet. If a two-, three- or four-hole faucet is to be installed, the holes must be added by a qualified plumber according to the faucet manufacturer's specifications.
2. Apply a 1/4" bead of silicone caulk around bottom of rim.

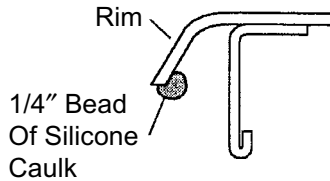

3. Set the dishwasher into the countertop cutout. Make sure that the front of the dishwasher is parallel to the front edge of the countertop. Immediately remove any excess caulking.

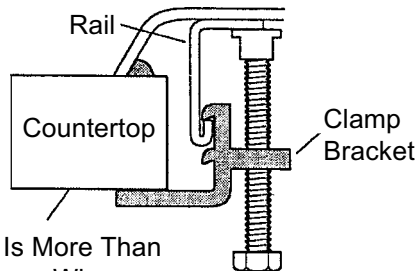

If Countertop Is More Than 3/4" Thick, Areas Where Clamp Brackets Are Installed MUST Be Routed To A Maximum Of 3/4"

4. Install two clamp brackets, evenly spaced, on the front, back, and left (sink) side clamp rails. Tighten the clamps.  
Optional: If space permits, install two clamp brackets, evenly spaced, on the right side rail.

## CONNECTING THE PLUMBING

1. Connect the sink and dishwasher drain plumbing.

2. Apply Teflon™ tape or pipe joint compound to the 90° elbow fitting, and connect the fitting to the water inlet valve. Use an adjustable wrench, and tighten the elbow until it is snug, and facing the direction for the water fill line installation.

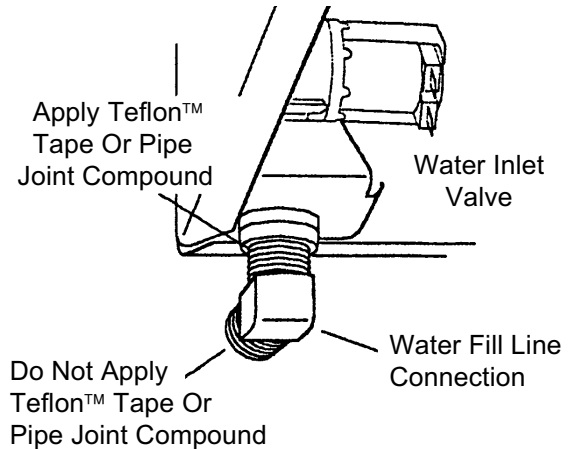

3. Connect the dishwasher water fill line, as follows:

- Slide the nut onto the copper tubing about 1".
- Slide the ferrule onto the tubing. Do not position the ferrule on the end of the tubing.
- Slide the tubing into the fill fitting as far as it will go.
- Slide the nut and ferrule forward and start the nut onto the elbow threads. NOTE: Be careful when handling the copper tubing that you do not kink it.
- Push the copper tubing into the elbow as far as it will go, and tighten the compression nut securely with a 5/8" open-end wrench.

4. Connect the hot and cold water lines to the faucet.
5. Turn on the water supply to the dishwasher and sink faucet and carefully check for leaks.
6. Plug the power supply cord into a 3-prong grounded outlet or turn on the power supply.
7. Run a complete cycle (refer to the Use and Care Guide), and check for leaks.

# HOT WATER BOOSTER TANK

## Product Dimensions

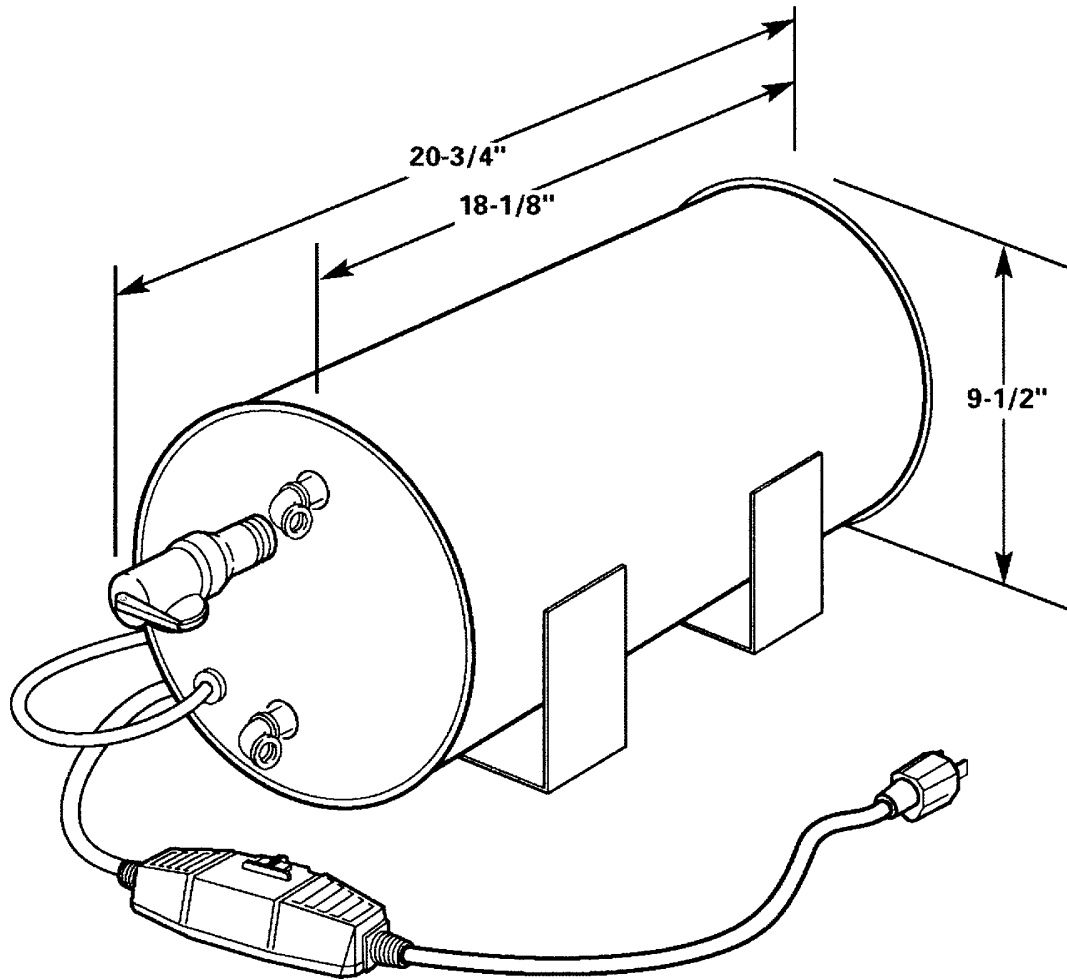

## General

### IMPORTANT SAFETY INSTRUCTIONS

WARNING - When using electrical appliances, basic safety precautions to reduce the risk of fire, electric shock, or injury to persons should be followed, including:

1. READ ALL INSTRUCTIONS BEFORE USING THIS WATER HEATER.
2. This water heater must be grounded. Connect only to properly grounded outlet.
3. Install or locate this water heater only in accordance with the provided installation instructions.
4. Use this water heater only for its intended use as described in this Job Aid.
5. Do not use an extension cord set with this water heater. If no receptacle is available adjacent to the water heater, contact a qualified electrician to have one properly installed.
6. As with any appliance, close supervision is necessary when used by children.
7. Do not operate the water heater if it has a damaged cord or plug, if it is not working properly, or if it has been damaged or dropped.

### TOOLS NEEDED

- Pliers
- 1/4" hex driver
- Plumbing for Temperature and Pressure Relief valve drain connection, as required
- Teflon® tape or pipe joint compound
- Adjustable wrench

® Teflon is a registered trademark of E.I. DuPont de Nemours and Company

**Your safety and the safety of others is very important.**

We have provided many important safety messages in this Job Aid and on the appliance. Always read and obey all safety messages.



This is the safety alert symbol. This symbol alerts you to hazards that can kill or hurt you and others. All safety messages will follow the safety alert symbol and either the word "DANGER" or "WARNING." These words mean:

**! DANGER**

**You can be killed or seriously injured if you don't immediately follow instructions.**

**! WARNING**

**You can be killed or seriously injured if you don't follow instructions.**

All safety messages will tell you what the potential hazard is, tell you how to reduce the chance of injury, and tell you what can happen if the instructions are not followed.

**Important: Observe all governing codes and ordinances.**

**Proper installation** is your responsibility.

- Contact a qualified installer.
- Installation must be performed by a qualified service technician. The hot water tank must be installed to all electrical and plumbing national and local codes and ordinances.
- Install the hot water tank as specified in these instructions.
- Have everything you need to properly install the hot water tank.



**Protect water lines leading to hot water tank against freezing. Damage from freezing is not covered by the warranty.**

**This accessory is to be used in non-pressurized applications only.**

**Thermal Expansion**—When a water heater is installed in a closed water supply system, such as one having a back-flow preventer in the cold-water supply, means shall be provided to control thermal expansion. Contact the water supplier or local plumbing inspector for information regarding the control of this situation.

**Tempering Valve**—This water heater is capable of supplying high temperature hot water. Tempering valves that limit hot water temperature are available for installation in hot water lines. Contact a licensed plumber or plumbing authority.

**Temperature and Pressure Relief (T & P) Valve drain requirements.**

CAUTION: To reduce the risk of excessive pressures and temperatures in this water heater, install temperature and pressure protective equipment required by local codes and no less than a combination temperature and pressure relief valve certified by a nationally recognized testing laboratory that maintains periodic inspection of production of listed equipment or materials, as meeting the requirements for Relief Valves and Automatic Gas Shutoff Devices for Hot Water Supply Systems, ANSI Z21.22-1986. This valve must be marked with a maximum set pressure not to

exceed the marked maximum working pressure of the water heater. Install the valve into an opening provided and marked for this purpose in the water heater, and orient it or provide tubing so that any discharge from the valve exits only within 6 inches above, or at any distance below, the structural floor, and does not contact any live electrical part. The discharge opening must not be blocked or reduced in size under any circumstances.

It is recommended that the drain location be planned before installing the hot water tank.

The T & P valve drain connection faces down. Locating the drain so that it is directly in line with the connection is recommended.

The T & P valve must be connected to an adequate drain line. A 1/2" male NPT thread is required to connect to the valve.

The valve discharge line must be as follows:

- Must not be smaller than the pipe size of the relief valve or have any reducing coupling installed in the discharge line.
- Must not be capped, blocked, plugged, or contain any valve between the relief valve and the end of the discharge line.
- Must terminate within 6 inches above a floor or any distance below the structural floor or external to the building.
- Must be installed to allow complete drainage of both the valve and discharge line.

In certain locations, a suitable drain pan must be installed and piped to a drain.

## Electrical Supply Requirements

### **⚠ WARNING**



#### **Electrical Shock Hazard**

**Plug into a grounded 3-prong outlet.**

**Do not remove ground prong.**

**Do not use an adapter.**

**Do not use an extension cord.**

**Failure to follow these instructions can result in death, fire, or electrical shock.**

This appliance is equipped with a GFCI power supply cord. **DO NOT REMOVE THIS CORD.**

If codes permit and a separate ground wire is used, it is recommended that a qualified electrician determine that the ground path is adequate.

**Do Not ground to a gas pipe.**

**The 3-prong grounded outlet must be properly polarized.**

**Check with a qualified electrician if you are not sure the outlet is properly grounded and polarized.**

**Do Not have a fuse in the neutral or ground circuit.**

A 120-volt, 60-Hz, AC-only, 15- or 20-ampere fused electrical supply is required. It is recommended that a separate circuit serving only this appliance be provided.

### **RECOMMENDED GROUND METHOD**

For your personal safety, this appliance must be grounded. This appliance is equipped with a power supply cord having 3-prong ground plug. To minimize possible shock hazard, the cord must be plugged into a mating 3-prong ground-type outlet, grounded in accordance with local codes and ordinances. If a mating outlet is not available, it is the personal responsibility and obligation of the customer to have a properly grounded and polarized 3-prong outlet installed by a qualified electrician.

The hot water tank will not operate if connected to an outlet that is not properly grounded.

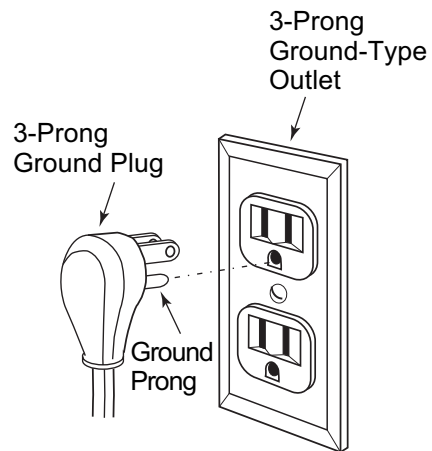

### **3-Prong Ground-Type Outlet Location**

It is recommended that the 3-prong ground-type outlet be located on the left hand side of the cabinet opening for easy access to power supply cord's built-in GFCI.

# Installing The Hot Water Tank

## PARTS SUPPLIED

- 1 - hose
- 2 - clamps
- 2 - barbed fittings

## PLUMBING CONNECTIONS

**Important:** Before installing the hot water tank, make these changes to the dishwasher.

### ⚠ WARNING

#### Excessive Weight Hazard

Use two or more people to move and install dishwasher.

Failure to do so can result in back or other injury.

1. Disconnect the hose, as shown. Slide the clamp back about 1" from the end of the hose, and loosen the retaining clip securing the hose to the dishwasher so that the hose will slide in the clip. Gently remove any slack in hose, but do not kink the hose. Save the retaining clip. The hose will be connected to the hot water tank hot water outlet, later.
2. Remove the hose that came with the hot water tank. Use the clamp that you saved in step 1, and slide it back on one end of the hose about 1" back from the end.

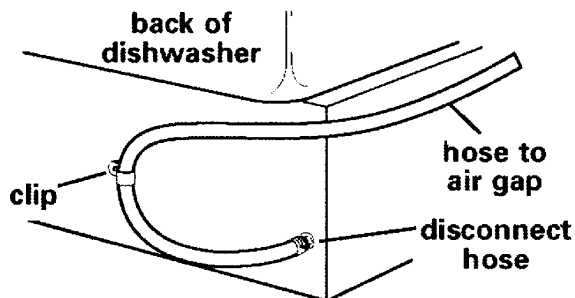

3. Push the end of the hose over the water valve hose connection as far as it will go.
4. Slide the clamp over the connection so that it is about 1/8" from hose end, and past the connection retaining ring.
5. Use one of the clamps supplied, and slide it on the other end of the hose about 1" back from the end. The hose will be connected to the hot water tank cold water inlet, later.

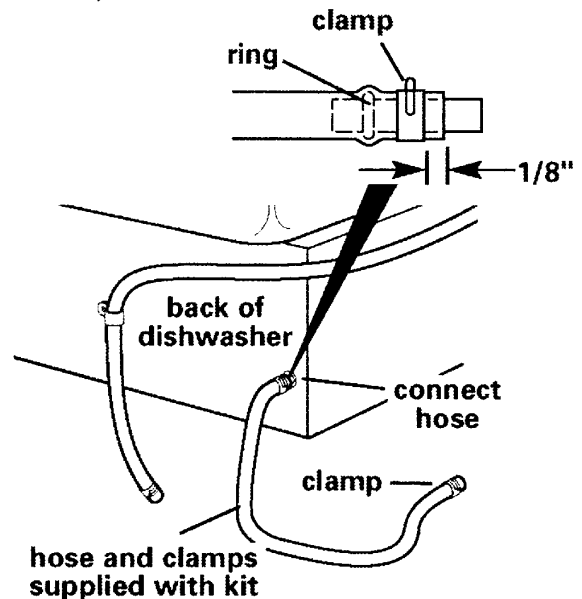

## INSTALLING THE HOT WATER TANK

**NOTE:** If hot water tank inlet and outlet are 1/2" NPT threaded fittings, then the supplied barbed fittings have to be connected prior to installation.

1. Apply Teflon® tape, or pipe joint compound, to the supplied fittings. Hold the elbow with pliers while tightening barbed fittings until they are snug.

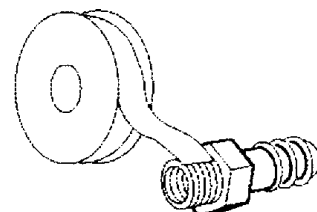

2. Move the hot water tank into its mounting location.
3. Connect the temperature and pressure relief valve to the drain line, as required by local codes.

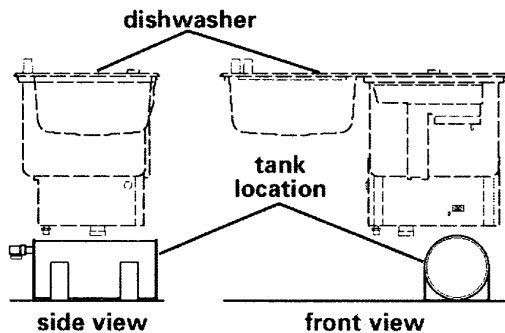

4. Connect the hose from the air gap (secured to dishwasher by a retaining clip) to the hot water outlet (upper) connection on the hot water tank. Push the hose on to the connection at least 1".
5. Use the remaining clamp supplied with the kit, and slide the clamp over the connection so that it is about 1/8" from hose end and past retaining ring on the connection, then tighten the clamp. Be careful not to kink the hose.

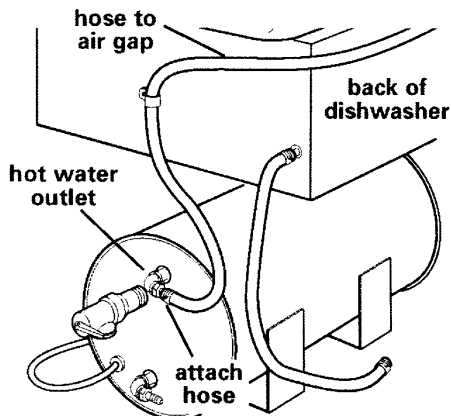

6. Connect the hose from the dishwasher water valve to the cold water (lower) inlet connection on the hot water tank (see the illustration at the top of the right column). Push the hose on to the connection at least 1". Slide the clamp over the connection so that it is about 1/8" from hose end and past retaining ring on connection, then tighten the clamp. Be careful not to kink the hose.

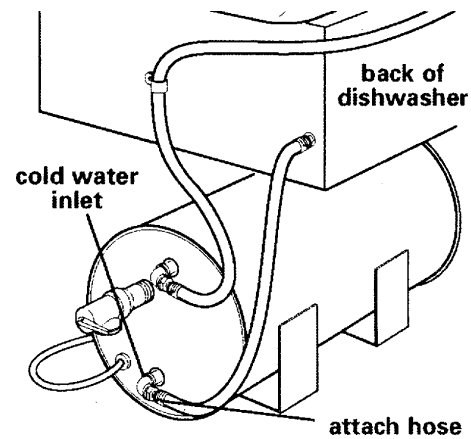

7. Check that there is power to the outlet and that it is properly grounded and polarized.
  8. Plug power supply cord into 3-prong grounded outlet. Position the power supply cord so that the built-in GFCI is easily accessible.
- IMPORTANT:** The following steps **MUST** be done **BEFORE** using the hot water tank to test and activate the GFCI
9. Press the reset button on the GFCI. The indicator should be visible.
  10. Press the test button on the GFCI. The indicator should disappear.
  11. Press the reset button. The indicator should reappear.

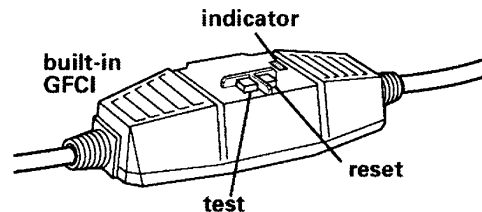

**If the GFCI fails this test, DO NOT use the hot water tank.**

**IMPORTANT:** If the dishwasher was installed and used **before** installing the hot water tank, perform the following step:

12. Refer to the Use and Care Guide that was included with the dishwasher, and run the dishwasher through a wash cycle. Check the hot water tank connections for leaks.  
NOTE: Wait about 45 minutes before starting the next cycle to allow the hot water tank to finish heating.

# PRODUCT OPERATION

## GROUND FAULT CIRCUIT INTERRUPTER (GFCI)

The dishwasher is provided with a Ground Fault Circuit Interrupter (GFCI). It is a built-in safety feature designed to protect against the dangers of line-to-ground electrical faults. If a fault of this type develops, the GFCI will disconnect the power to the dishwasher. The GFCI should be tested once a month.

To do this test, perform the following steps:

1. Press the “Test” button. The LED indicator should be “OFF” (not visible in the window).
2. Press the “Reset” button. The LED indicator should be “ON” (visible in the window).

**IMPORTANT:** Do not use the dishwasher if the GFCI test fails. Call the KitchenAid Customer Interaction Center number at:

**1-800-422-1230.**

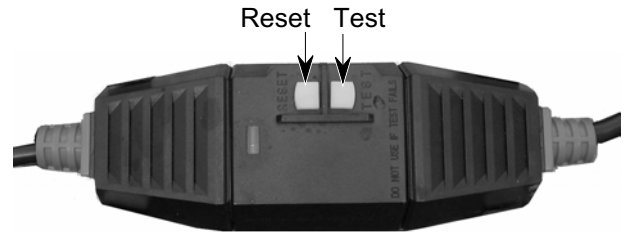

Ground Fault Circuit Interrupter (GFCI)

## PRESSURE SWITCH

A pressure switch is used to fill the dishwasher with approximately 3.1 liters or 3/4 gallon per fill. A second switch in the pressure switch protects against an overflow condition.

The sensing tubing for the pressure switch is routed from the sump air dome to the pressure switch. A protective cover is provided for the pressure switch tubing at the sump to prevent foreign materials from entering the tubing. The tubing is also routed to one of the air gaps and back to the switch, providing protection against suds forming in the tubing and filling it. Should the tubing become filled with suds, the pressure switch would be unable to sense water

levels. By keeping the pressure switch tubing higher than the water level in the dishwasher, any suds buildup can drain back into the tank.

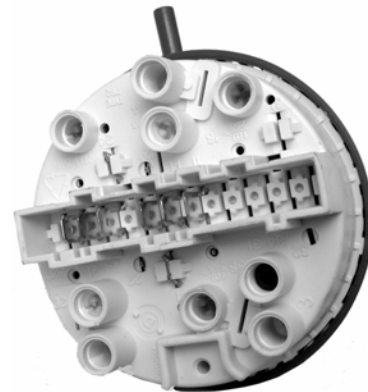

Pressure Switch

## LID LATCH

A lid latch mechanism holds the dishwasher lid closed during the cycle. A wax motor and trip arm assembly are mounted alongside the lid mechanism to open the lid at the end of the cycle. Once the dishwasher has reached the final rinse, the wax motor is energized for the final two minutes. As the wax motor reaches its full extension, it moves the attached release arm to disengage the lid latch, and allow the lid to pop open. The opening of the lid, coupled with the high water temperatures, causes the dish load to “flash dry,” due to the sudden venting of the heat and steam in the dishwasher. This is the only means of drying. No heating element is provided for drying dishes.

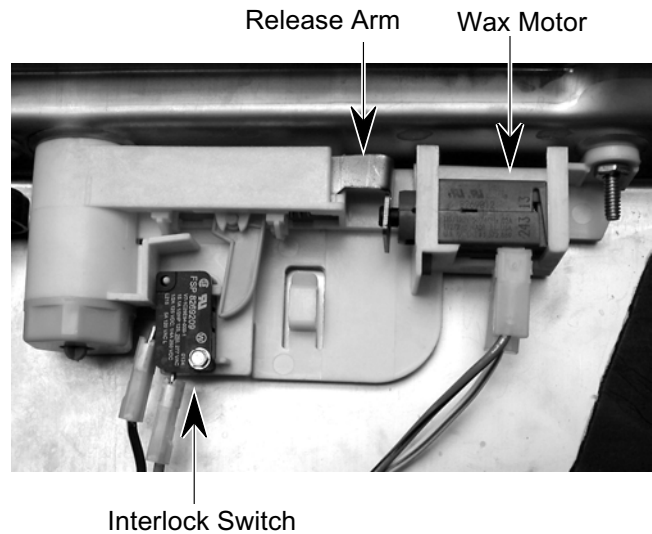

---

## INLINE WATER HEATER

An inline water heater is used to heat water during the cleaning cycle. The heater is located between the sump and the wash pump. Water from the sump flows through the heater, into the wash pump inlet, and is then recirculated through the poppet valve into the tank.

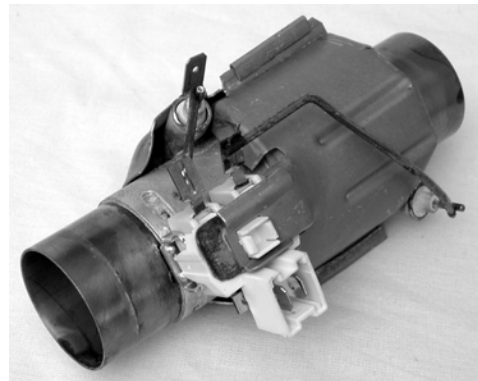

---

## OPTIONAL AUXILIARY WATER HEATER

An auxiliary water heater can be installed to boost the water temperature for immediate hot water at the beginning of the cycle. The auxil-

iary water heater consists of a 2-1/2 gallon tank, and a 1100 Watt heating element. The water heater heats the water to a temperature of 165°F / 74°C to provide a shorter wash cycle.

# CYCLE SELECTION CHARTS

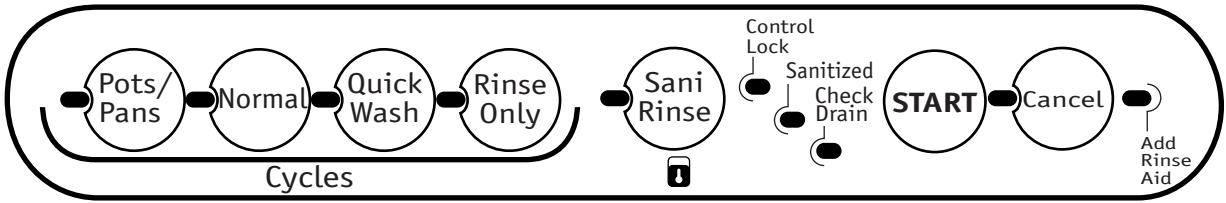

Select the wash cycle and option desired, or press the Start pad to repeat the same cycle and option as the previous cycle.

NOTE: If the last cycle you completed was a rinse cycle, the dishwasher will run the last full wash cycle and option that you selected when you press the Start pad.

A “●” shows what steps are in each cycle.

Temperatures indicate where extra heat is added.

Water usage is shown in U.S. gallons/liters.

Cycle time includes dry time. An asterisk ( \* ) by the cycle time indicates the cycle time might be longer depending on the temperature of the water entering the dishwasher. The cooler the water, the longer the cycle time. If the water is already hot enough, the cycle time will be as shown in the following charts.

Use this cycle for heavily soiled pots, pans, casseroles, and regular silverware.							
Main Wash	Rinse	Purge+	Rinse	Final Heated Rinse	Dry	Time (min)	Water Usage (gal/L)
● 145°F (61°C)	●	●	●	● 145°F (61°C)	●	49*	4.1/15.7

Use this cycle for loads with normal amounts of food soil. (The energy-usage label is based on this cycle.)							
Main Wash	Rinse	Purge+	Rinse	Final Heated Rinse	Dry	Time (min)	Water Usage (gal/L)
● 145°F (61°C)	●	●	●	● 145°F (61°C)	●	37*	4.1/15.7

Use this cycle for light loads, light soil, or glassware.					
Main Wash	Rinse	Final Heated Rinse	Dry	Time (min)	Water Usage (gal/L)
● 145°F (61°C)	●	● 145°F (61°C)	●	21*	2.5/9.5

Use this rinse cycle for rinsing dishes, glasses, and silverware that will not be washed right away. <b>Do not use detergent with this cycle.</b>					
Main Wash	Rinse	Final Heated Rinse	Dry	Time (min)	Water Usage (gal/L)
	●			3	0.9/3.5

\* A small amount of water is run through the pump to remove soil particles. Anytime during the cycle, open the lid, press Cancel, and close the lid.

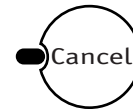

Cancel glows, and the dishwasher starts a drain. Let the dishwasher drain completely. If the dishwasher does not need draining, the light will turn off. Select a new cycle.

### To stop the drain:

You can press Cancel again to stop the drain immediately. Remember to drain the dishwasher before starting a new cycle.

### To clear the indicators:

Press Cancel before starting the dishwasher to clear all options and cycles.

## CHANGING A CYCLE OR SETTING

### During the first fill of a cycle:

1. Open the lid.
2. Press a new cycle and/or options.
3. Check the detergent. Dishwasher must contain the proper amount for the new cycle.
4. Close and latch the lid. The dishwasher resumes the new cycle and/or option after a 5-second pause.

### After the first fill of a cycle:

1. Open the lid.
2. Press the Cancel pad.

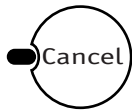

3. Close the lid, and the dishwasher starts a drain. Let the dishwasher drain completely.
4. Open the lid.
5. Select a new cycle and/or options.
6. Check the detergent. Dishwasher must contain the proper amount for the new cycle.
7. Press the Start pad.
8. Close and latch the lid.

## ADDING ITEMS DURING A CYCLE

You can add an item anytime before the main wash starts. Open the lid and check the detergent amount. If the detergent is still visible, you can add items.

### To add Items:

1. Turn the knob latch and lift up the lid to stop the cycle. Wait for the spraying action to stop before opening the lid completely.
2. Open the lid. If the detergent is still visible, add the item.
3. Close the lid firmly and turn knob to latch it. The dishwasher resumes the cycle after about a 5-second pause.



## OPTION SELECTIONS

You can customize your cycles by pressing the SANI RINSE™ option. If you change your mind, press the option again to turn the option off.

You can change an option anytime before the selected option begins.

Press the Start pad to repeat the same cycle and option as the previous wash cycle.

NOTE: If the last cycle you completed was a rinse cycle, when you press the Start pad, the dishwasher runs the last full wash cycle and option.

### SANI RINSE™ Option

Select this option to raise the water temperature in the final rinse to approximately 160°F (71°C). Sani Rinse adds heat and time to the cycle.

NOTE: Sani Rinse is an option with the Pots/Pans and Normal cycles.



### Control Lock

Use Control Lock to prevent unintended use of the dishwasher. You can also use the Control Lock feature to prevent unintended cycle, or option changes during a cycle.



When Control Lock is lit, all buttons are disabled.

NOTES:

- The dishwasher lid can be opened while the controls are locked.
- You can turn on the Lock while the dishwasher is running.

### To turn on the Lock:

Press and hold the SANI RINSE™ option key for 4 seconds. The Control Lock glows.



If you press any pad while your dishwasher control is locked, the light flashes 3 times.

### To turn off the Lock:

Press and hold SANI RINSE™ option key for 4 seconds. The light turns off.

### IMPORTANT:

- Operate the dishwasher only when you are at home.
- If your home is equipped with a water softener, do not start the dishwasher during the regeneration of the softener.

# CYCLE STATUS INDICATORS

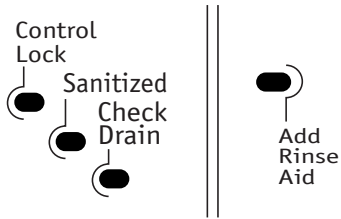

Cycle Status indicators

## Control Lock

When Control Lock is lit, all buttons are disabled.

## Sanitized

If you select the SANI RINSE™ option, Sanitized glows when the Sani Rinse cycle is finished. If your dishwasher did not properly sanitize your dishes, the light flashes at the end of the cycle. This can happen if the cycle is interrupted or the incoming water temperature is too low. The light goes off when you open and close the lid.

## Check Drain

If the dishwasher senses the drain stopper is not closed properly, the cycle immediately ends, the lid pops open, and the Check Drain indicator is lit.

## Add Rinse Aid

Fill the Rinse Aid dispenser when the Add Rinse Aid indicator is lit. A rinse aid prevents water from forming droplets that can dry as spots or streaks. Rinse Aid is essential for efficient drying.

If the Rinse Aid dispenser is empty, the light glows when you select a cycle, or while a cycle is running.

## briva™ WASH SYSTEM

The three-level wash system provides excellent cleaning results. Three levels of filtration filter the wash water, and prevent food particles from redepositing on the clean dishes. The three levels operate as follows:

- A coarse strainer as part of the Drain Stopper assembly (1), prevents bones, pits, and other large objects from entering the pump system.
- Items small enough to pass through the coarse strainer are caught in the Drain Screen Basket (2).
- The wash water continuously flows through the Drain Fine Screen Filter (3), trapping food particles.
- Two water jets, located under the spray arm, remove the food particles from the Drain Fine Screen Filter.

NOTE: Before each wash load, check the coarse strainer, the drain screen basket and the drain fine screen filter and remove any objects and soil particles.

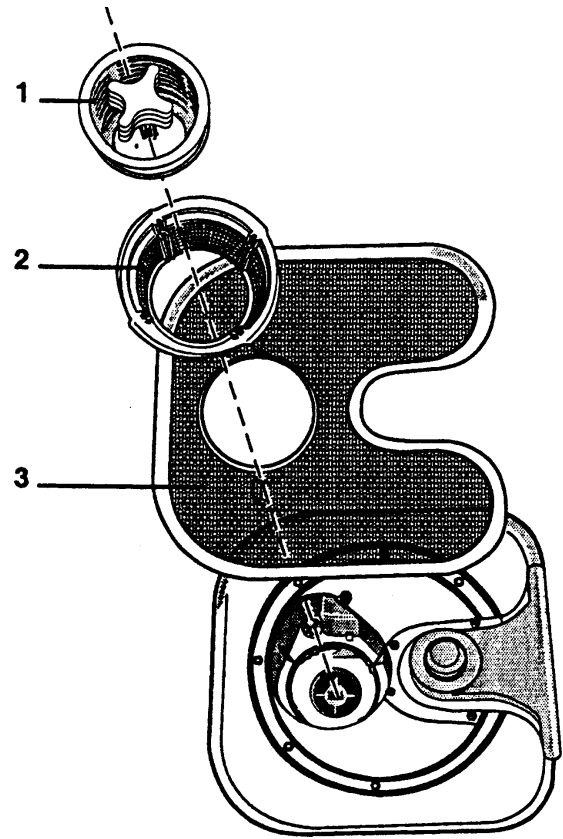

## DRYING SYSTEM

The briva™ wash system features FLASHDRY™ instant drying. At the end of the cycle, the lid automatically pops open, allowing vapor to escape, aiding in fast, efficient, dishload drying.

**IMPORTANT:** The vapor is hot. Do not touch the lid opening during drying. Do not place anything on top of the lid when running a cycle.

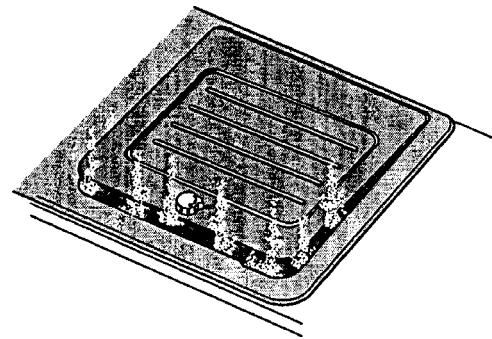

# Hot Water Tank Operation

## ⚠ WARNING

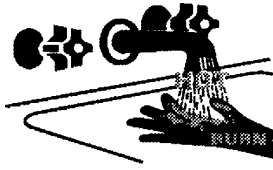

**Water temperature over 120°F can cause severe burns instantly or death from scalds.**

**Children, disabled, and elderly are at highest risk of being scalded.**

**See instructions manual before setting temperature at water heater.**

**Feel water before bathing or showering.**

**Temperature limiting valves are available.**

The water supply **MUST** be turned ON before operating the hot water tank. Operating the hot water tank without the water supply turned on could damage the hot water tank.

NOTE: When the hot water tank is first used, it will take about 45 minutes for the hot water tank to finish heating the tank water to the selected temperature after the first dishwasher cycle is completed. The hot water tank will then continually maintain the temperature set by the Temp Control switch.

When the hot water tank is first heated, it is normal for a slight amount of water to be discharged into the dishwasher.

## TEMP CONTROL SWITCH

The Temp Control switch allows the temperature setting to be changed.

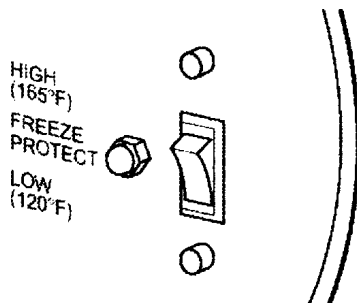

To reduce the risk of scald injury, the Temp Control switch has been factory set to “LOW” (bottom position) which heats water to 120°F / 49°C.

If faster dishwasher cycle time is desired, the Temp Control switch can be set to “HIGH” (top position) which heats water to 165°F / 74°C.

The FREEZE PROTECT (center) setting will restart the tank periodically to prevent freezing. Use this setting if the hot water tank and dishwasher will not be used for an extended period of time.

## GROUND FAULT CONTROL INDICATOR (GFCI)

Test the GFCI once a month (see Steps 9 through 11 on Page 2-14).

If the GFCI will not reset and the outlet is properly grounded and polarized, disconnect the power supply cord, and **DO NOT use the hot water tank.**

## LOCKOUT CONDITION

If either light blinks, the tank is in a “lockout” condition.

To reset, disconnect the power supply cord for 1 minute, and then reconnect the power.

If this does not correct the “lockout” condition, **DO NOT use the hot water tank.**

THE HOT WATER TANK ACCESSORY IS NOT INTENDED TO BE SERVICED. ANY TAMPERING WITH THE ACCESSORY WILL VOID THE WARRANTY.

# COMPONENT ACCESS

This section instructs you on how to service each component inside the Briva InSink Dishwasher. The components and their locations are shown below.

## COMPONENT LOCATIONS

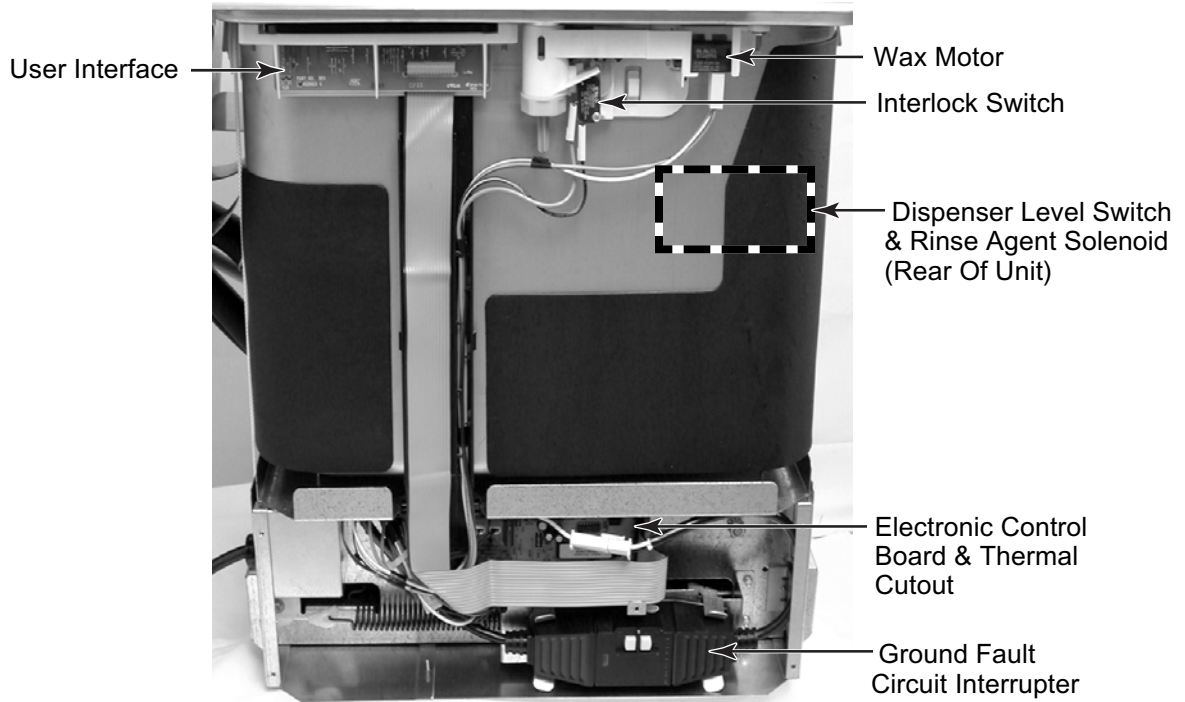

**Front Components**

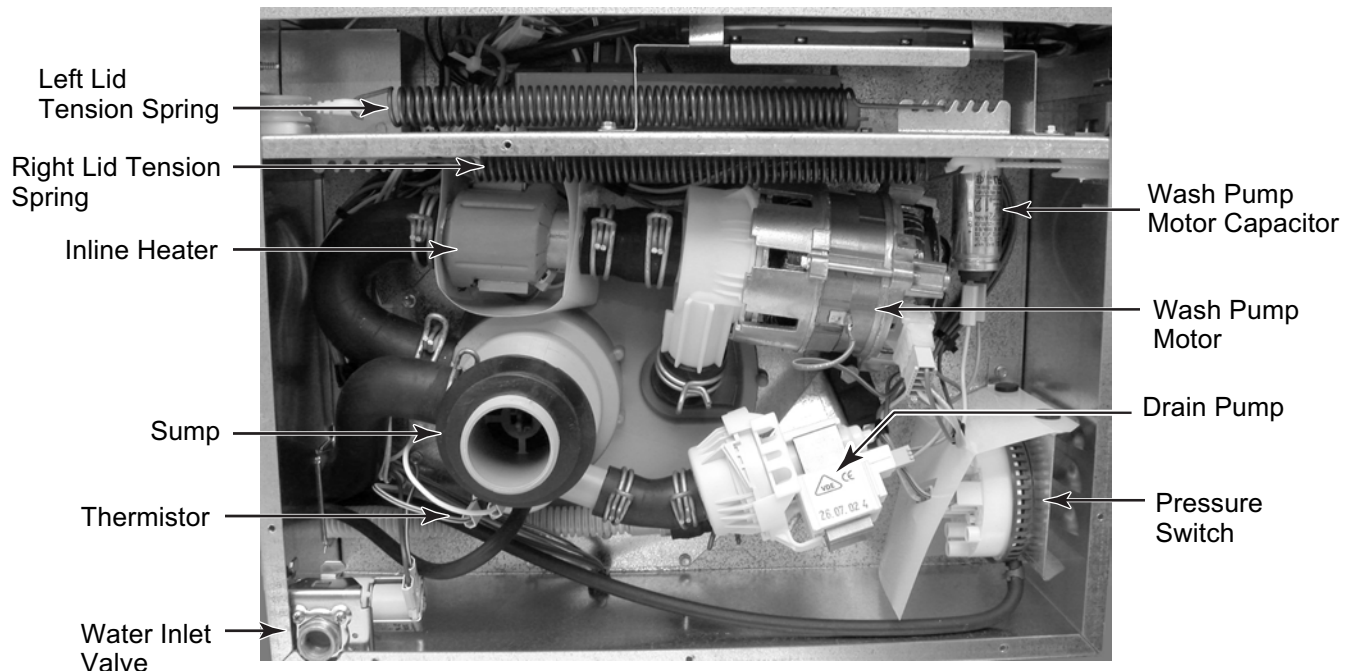

**Bottom Components**

## REMOVING THE SPRAY ARM

### **!WARNING**



#### **Electrical Shock Hazard**

**Disconnect power before servicing.**

**Replace all parts and panels before operating.**

**Failure to do so can result in death or electrical shock.**

1. Unplug dishwasher or disconnect power.
2. Open the dishwasher lid.
3. Lift the loading rack out of the dishwasher and lay it upside down on a work surface.



Poppet

4. Press in on the locking tab and unclip the spray arm from the loading rack.

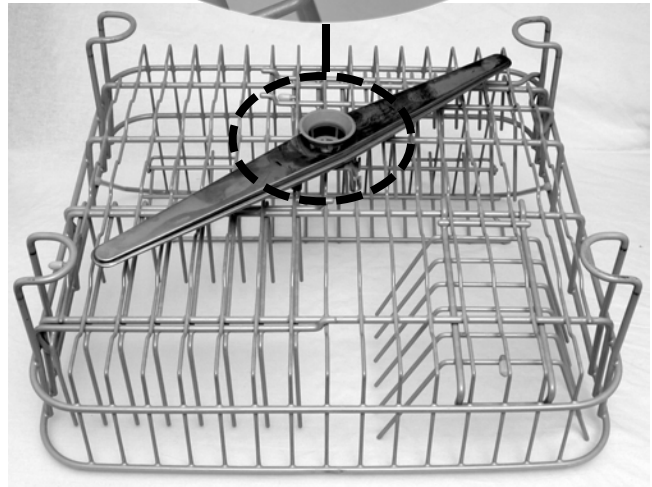
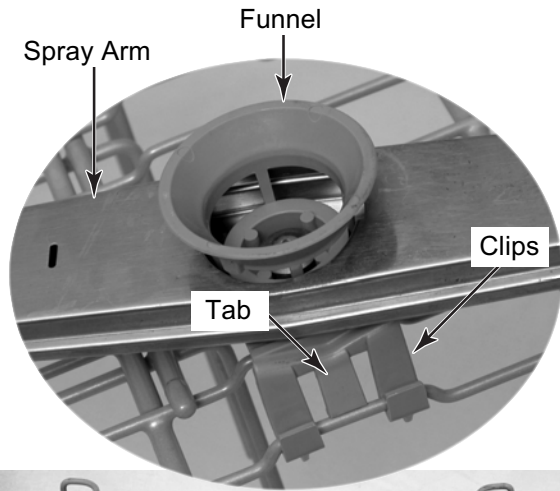

**REASSEMBLY NOTE:** When reassembling the spray arm, be sure to locate it in the center of the loading rack.

Reinstall the loading rack so that the funnel (see the inset above) on the bottom of the spray arm is over the valve poppet.

## REMOVING THE POPPET

### **!WARNING**



**Electrical Shock Hazard**  
**Disconnect power before servicing.**  
**Replace all parts and panels before operating.**  
**Failure to do so can result in death or electrical shock.**

1. Unplug dishwasher or disconnect power.
2. Open the dishwasher lid.
3. Lift the loading rack out of the dishwasher.
4. Turn the drain filter assembly 1/4-turn in either direction to unlock it, and lift the assembly out of the microfilter.



5. Turn the microfilter counterclockwise to unlock it, and lift it out of the dishwasher.

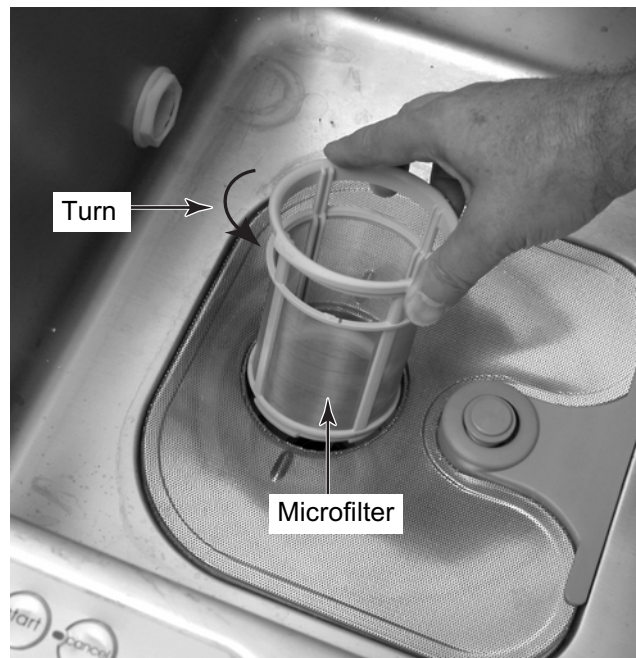

6. Lift and remove the sieve from the dishwasher.



**Continued on the next page.**

7. Remove the four T-15 Torx screws from the poppet cover and remove the cover.

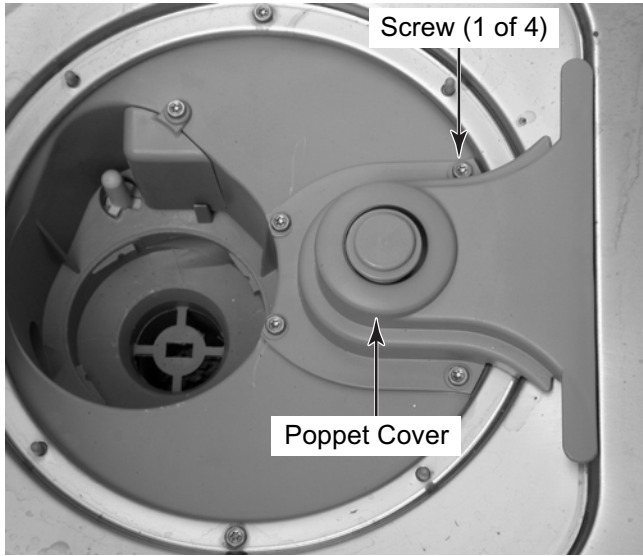

8. Lift the poppet out of its hole location in the dishwasher and remove it.

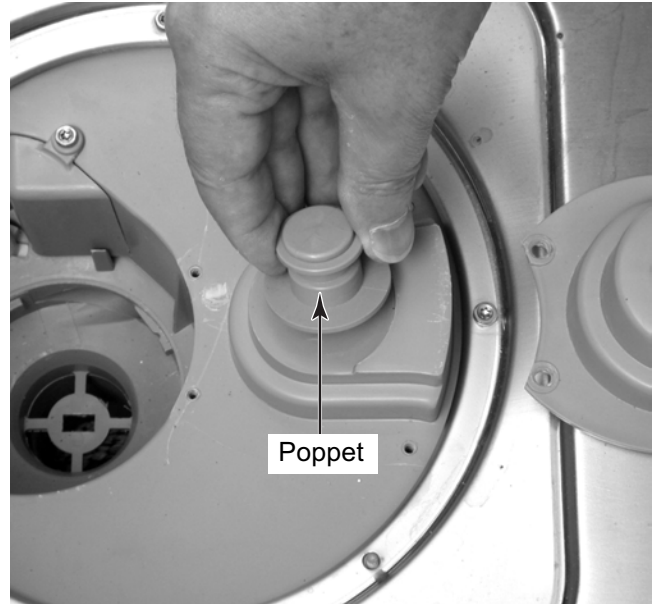



## REMOVING THE DRAIN AND FILL AIR GAPS

### **!WARNING**



**Electrical Shock Hazard**  
**Disconnect power before servicing.**  
**Replace all parts and panels before operating.**  
**Failure to do so can result in death or electrical shock.**

1. Unplug dishwasher or disconnect power.
2. Pull the cap off the air gap (drain or fill) you are removing.

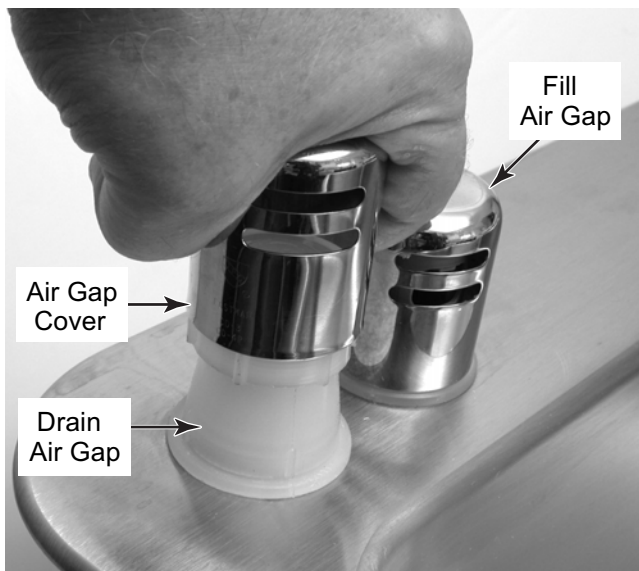

3. Remove the plastic nut and gasket from the air gap.
4. Disconnect the two hoses from the air gap and remove the air gap from the dishwasher.

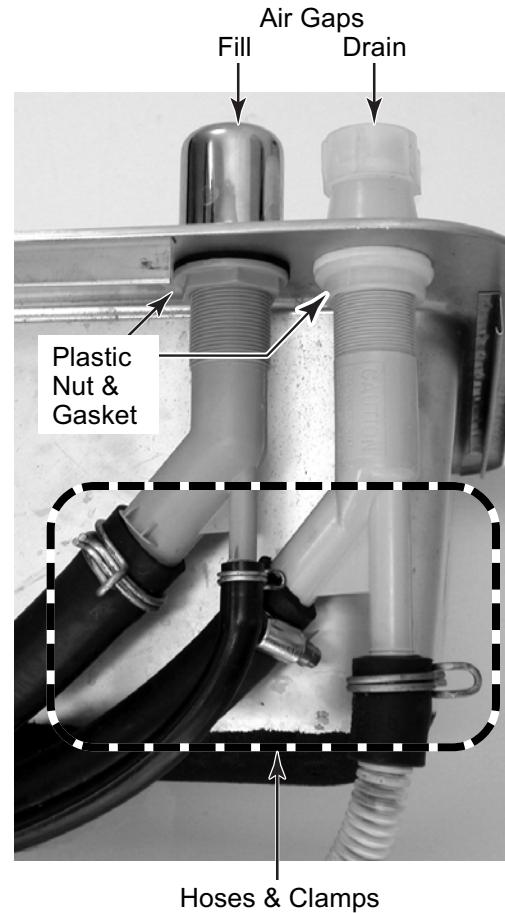

# REMOVING THE DISPENSER LEVEL SWITCH AND THE RINSE AGENT SOLENOID

## ⚠️ WARNING



### Electrical Shock Hazard

Disconnect power before servicing.

Replace all parts and panels before operating.

Failure to do so can result in death or electrical shock.

1. Unplug dishwasher or disconnect power.
2. Turn off the water going to the dishwasher.
3. Disconnect the drain line from the dishwasher.
4. Remove the dishwasher from the counter and place it on a protected surface.
5. Open the dishwasher lid.

6. Unscrew and remove the plastic cap from the fill spout.
7. Remove the plastic nut and o-ring from the rinse agent dispenser and the plastic nut from the fill spout.

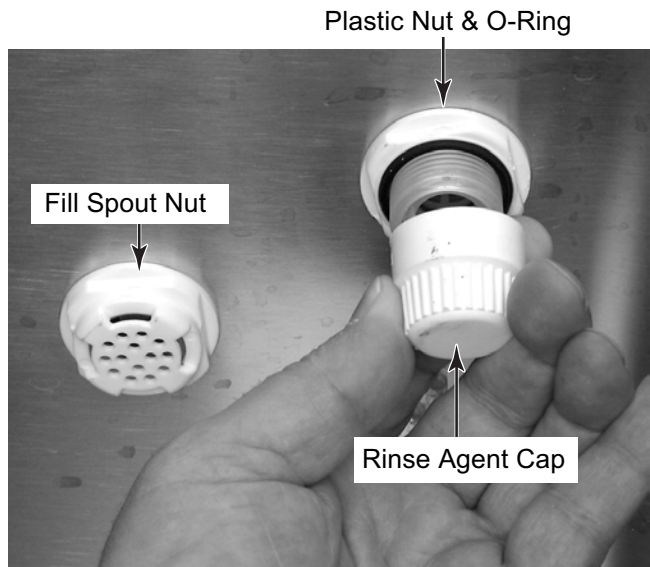

8. Remove the T-15 Torx screw from the dispenser housing at the back of the dishwasher.

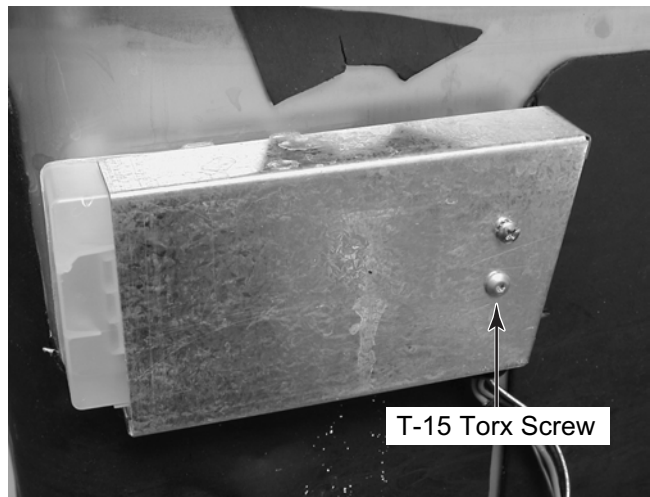
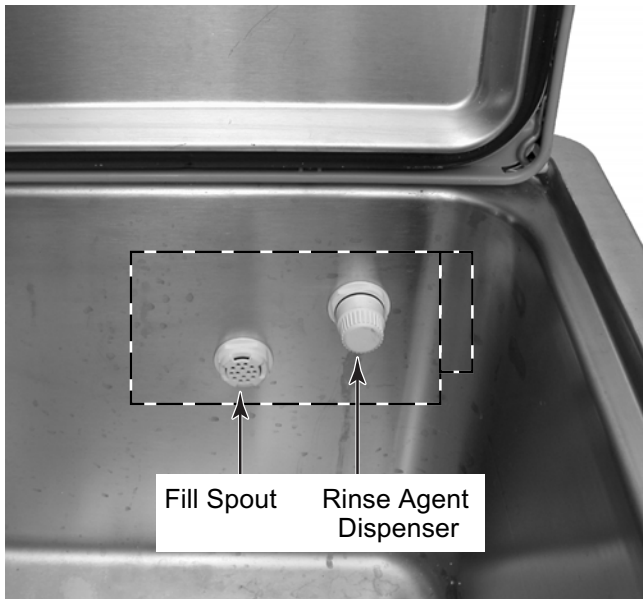

9. Pull the fill spout and rinse agent dispenser assembly off the back of the dishwasher and empty any of the liquid in the dispenser into a container.

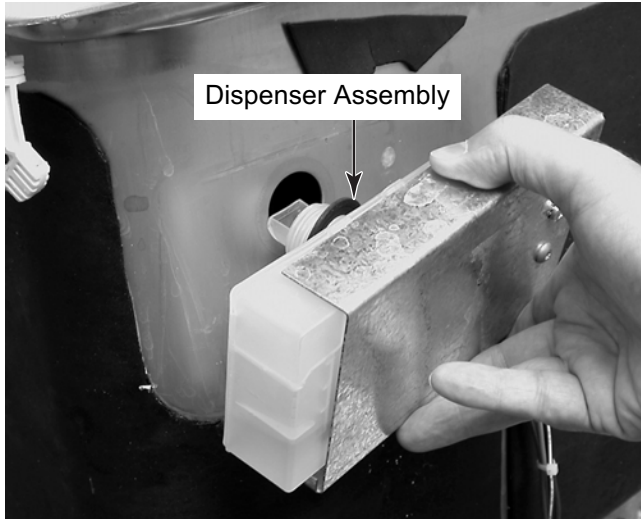

10. **To remove the dispenser level switch:**

- a) Remove the rinse agent solenoid and rubber seal from the dispenser tank (see step 11 for the procedure).
- b) Disconnect the wires from the switch terminals.
- c) Remove the rubber seals from the dispenser tank. Replace the seals if they are cracked or torn.

NOTE: The switch and tank are replaced as an assembly.

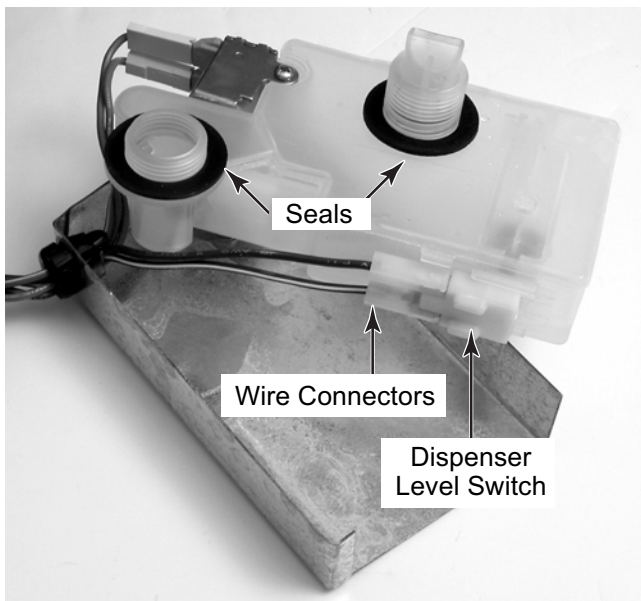

11. **To remove the rinse agent solenoid:**

- a) Remove the dispenser tank from the housing and disconnect the wires from the solenoid terminals.
- b) Remove the mounting screw and remove the solenoid and rubber seal. NOTE: Replace the rubber seal with the solenoid.

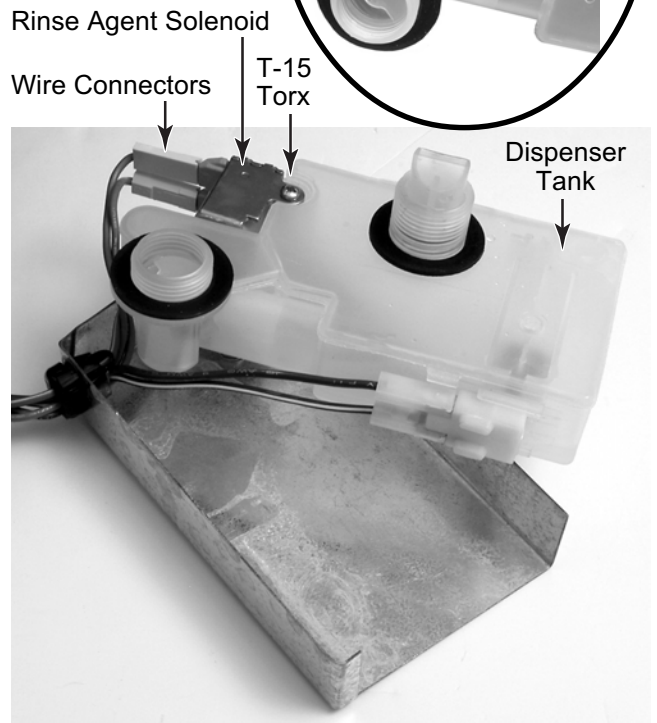
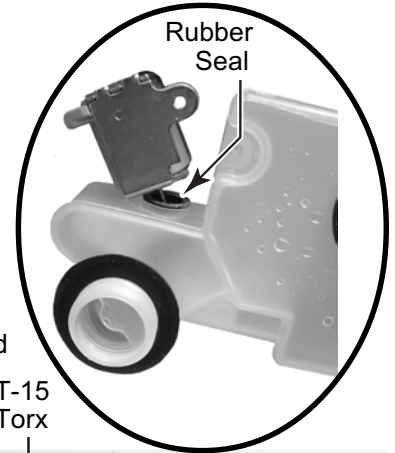

# REMOVING THE USER INTERFACE, THE INTERLOCK SWITCH, LATCH ASSEMBLY, AND WAX MOTOR

## ⚠️ WARNING



### Electrical Shock Hazard

Disconnect power before servicing.

Replace all parts and panels before operating.

Failure to do so can result in death or electrical shock.

1. Unplug dishwasher or disconnect power.
2. **To remove the user interface and the touch panel:**

a) From under the sink, remove the two ribbon cable cover nuts from the studs.



b) Remove the five screws from the front panel and remove the panel.

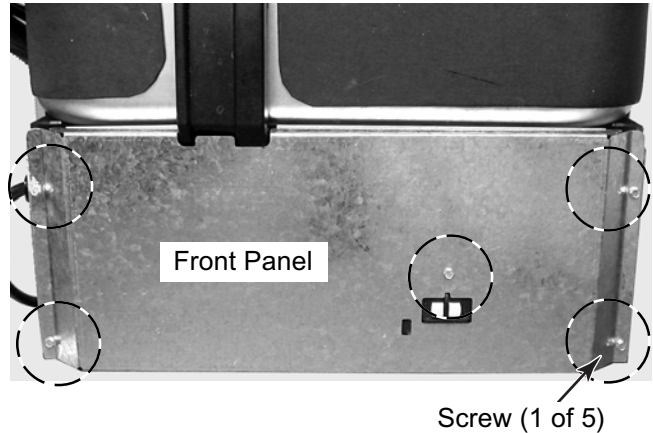

c) Slide the ribbon cable cover down so the channel cover is free of the locking tabs and remove the cover.

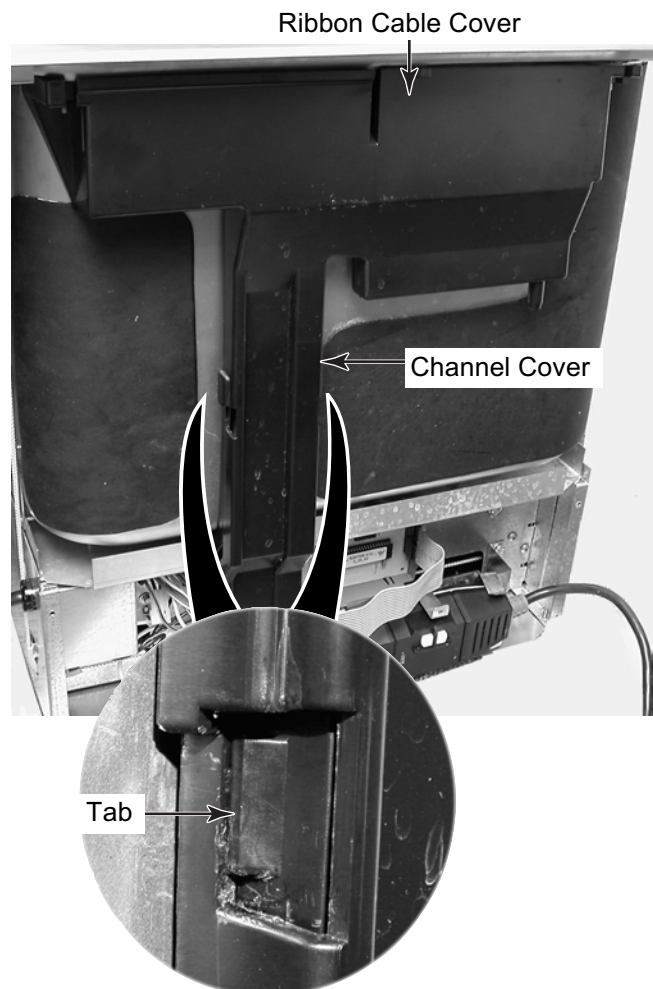

- d) Unplug the user interface ribbon cable from the electronic control.

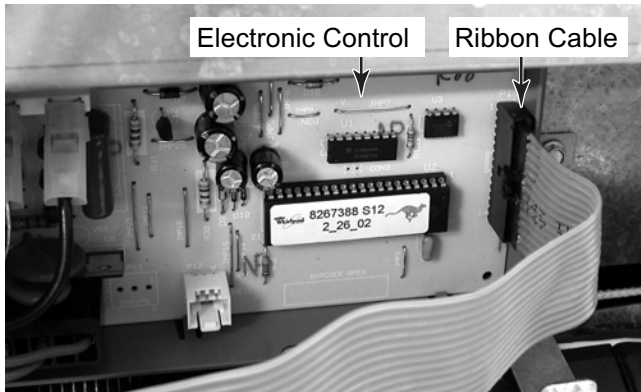

- e) Use a 3/8" socket and remove the two mounting nuts from the user interface and remove the interface assembly.

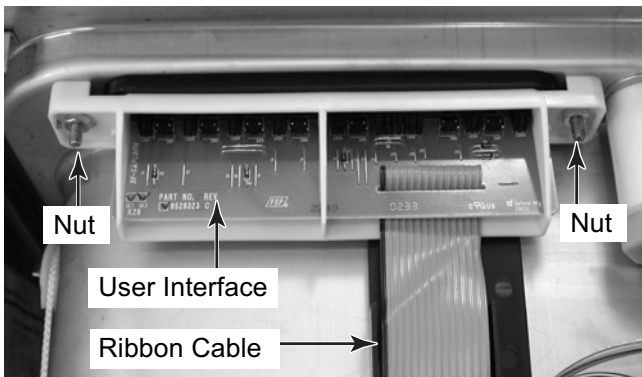

- f) Lift the touch panel with its rubber seal, the light shield, and the contact cover off the user interface controls.

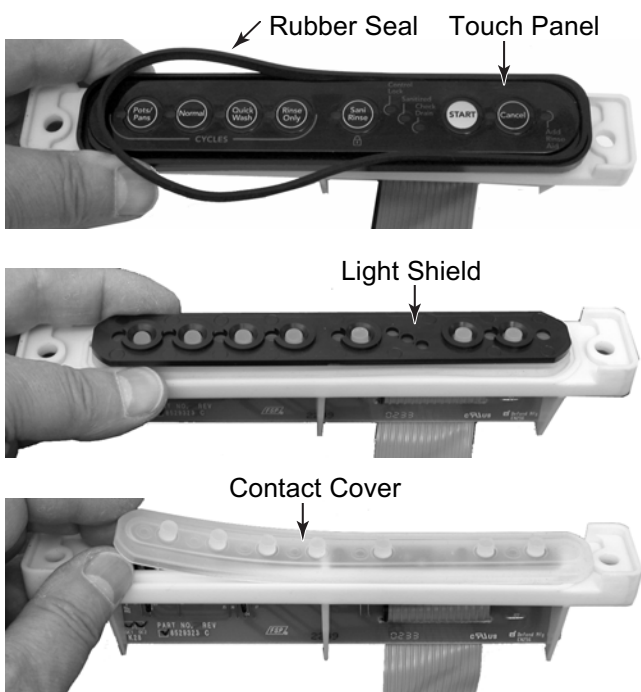

- g) Slide the user interface board out of the holder.

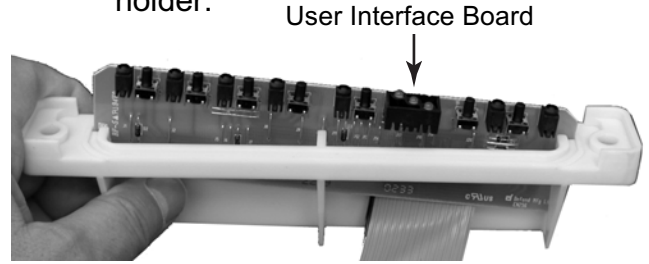

3. **To remove the interlock switch:**

- a) Remove the front panel and ribbon cable cover (see steps 2a and 2b).
- b) Disconnect the wire connectors from the interlock switch terminals.
- c) Remove the switch screw.

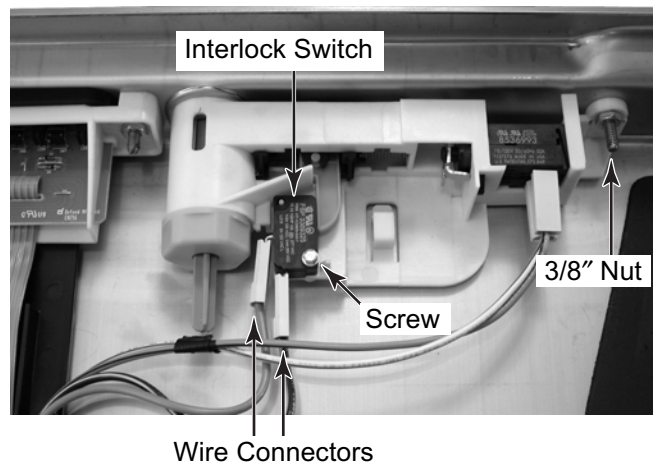

4. **To remove the latch assembly and wax motor:**

- a) Turn off the water going to the dishwasher.
- b) Disconnect the drain line from the dishwasher.
- c) Remove the dishwasher from the counter and place it on a protected surface.
- d) Remove the front panel and ribbon cable cover (see steps 2a and 2b).
- e) Remove the 3/8" nut from the right mounting stud (see the photo above).

**Continued on the next page.**

- f) Disconnect the wire connectors from the interlock switch and the wax motor.
- g) Remove the plastic retaining nut from the button holder, and remove the button, spring, and latch assembly from the dishwasher. NOTE: There is spring tension against the retaining nut, so use caution, since the spring will be released when the nut is removed.

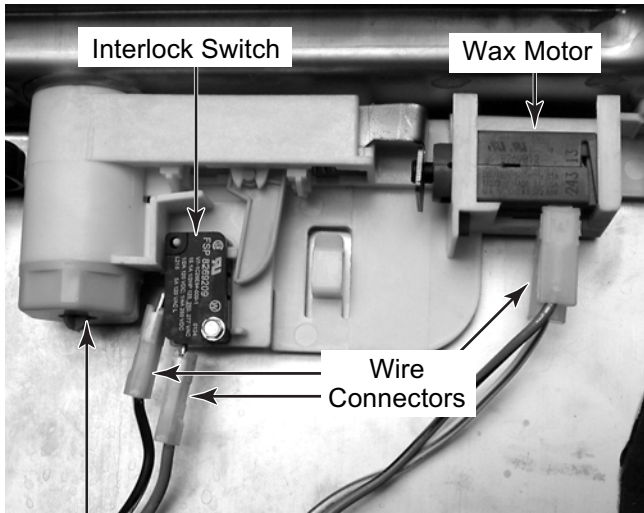

Plastic Retaining Nut

- h) Press in on the locking tab, and slide the wax motor and its linkage out of the latch assembly.

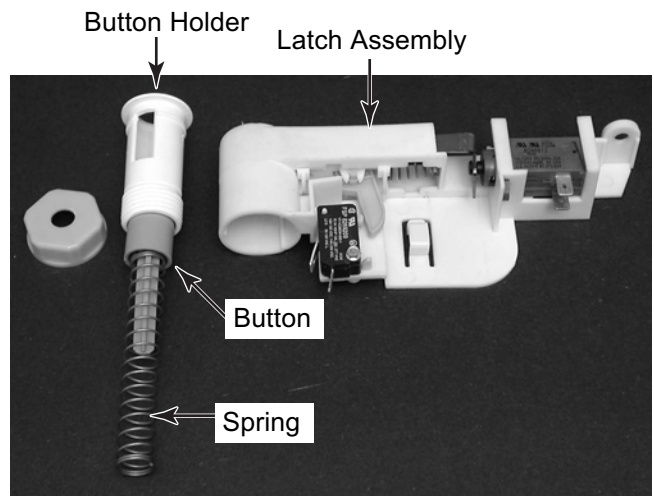
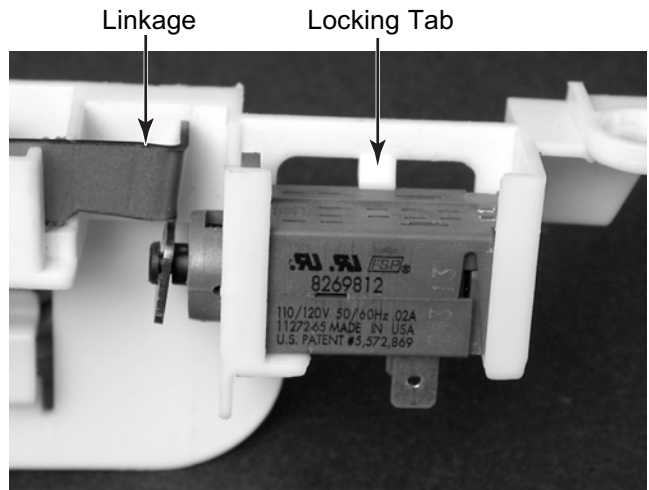

# REMOVING THE GROUND FAULT CIRCUIT INTERRUPTER, ELECTRONIC CONTROL BOARD, AND THERMAL CUTOUT

## **!WARNING**



**Electrical Shock Hazard**  
**Disconnect power before servicing.**  
**Replace all parts and panels before operating.**  
**Failure to do so can result in death or electrical shock.**

1. Unplug dishwasher or disconnect power.

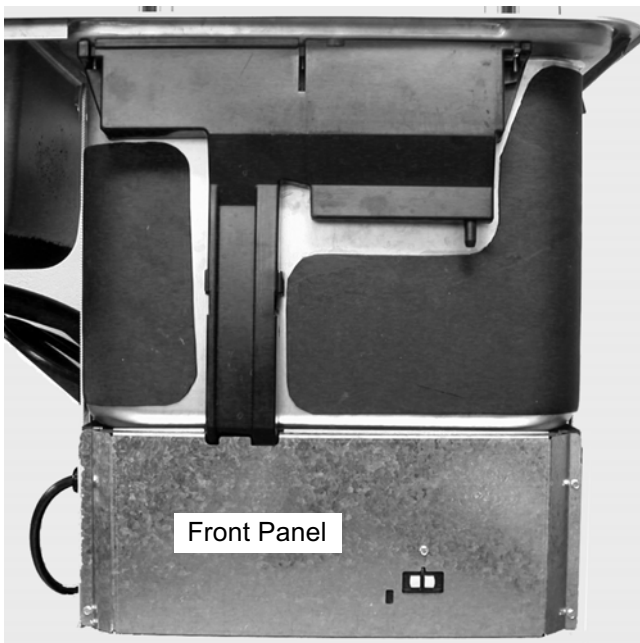

2. From under the sink, remove the five screws from the front panel and remove the panel.

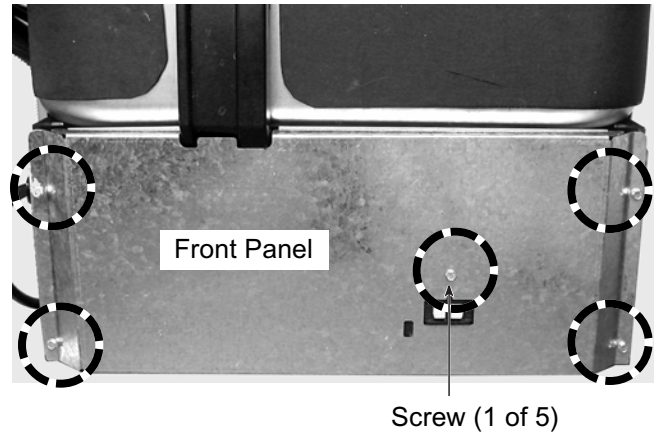

3. **To remove the ground fault circuit interrupter (GFCI):**

- a) Disconnect the cables from the wiring harness and AC power cord.
- b) Unclip the GFCI and remove it.

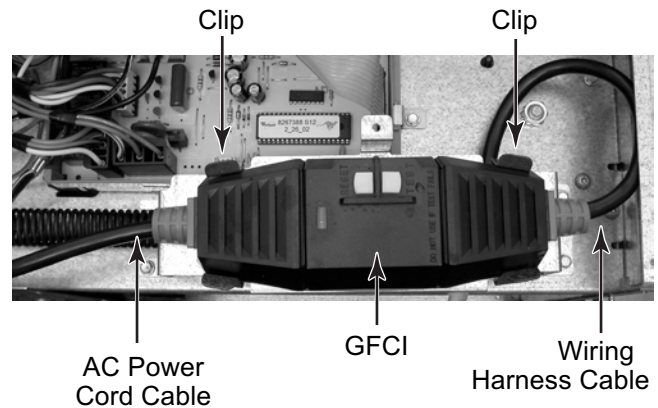

**Continued on the next page.**

4. **To remove the electronic control board and the thermal cutout:**

- a) Disconnect the wire connectors at P2, the thermal cutout terminals, P4, CON2, and the ribbon cable at P1.
- b) Remove the screw from the mounting bracket and remove the housing and board from the dishwasher.

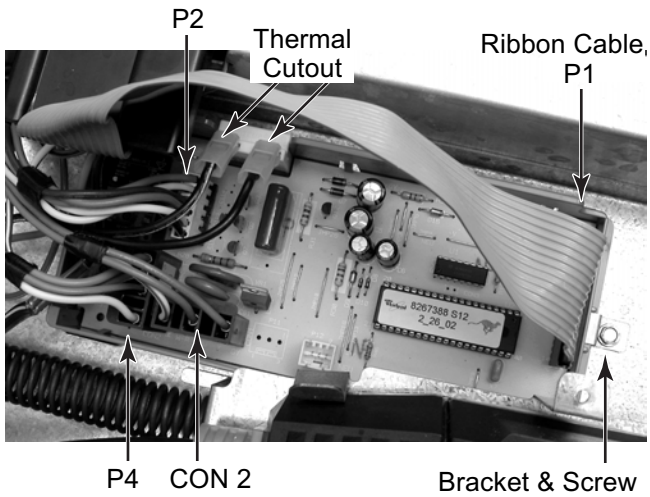

- c) Unclip the thermal cutout from the electronic control board housing and remove the cutout.

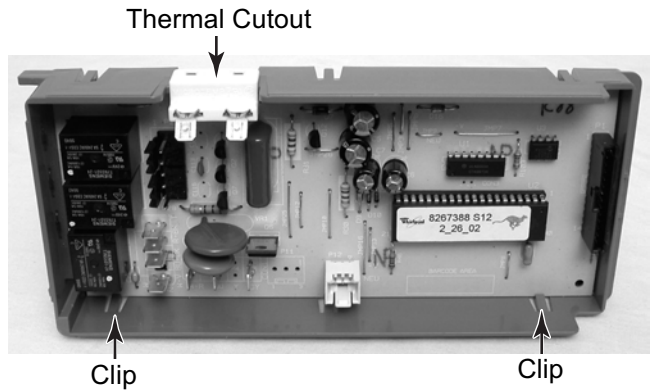



## REMOVING THE WATER INLET VALVE

### **!WARNING**



**Electrical Shock Hazard**  
**Disconnect power before servicing.**  
**Replace all parts and panels before operating.**  
**Failure to do so can result in death or electrical shock.**

1. Unplug dishwasher or disconnect power.
2. Turn off the water going to the dishwasher.
3. Disconnect the water supply line to the water inlet valve.
4. Except for the indicated three screws, remove the remaining screws from the two bottom panels and remove the panels from the dishwasher.

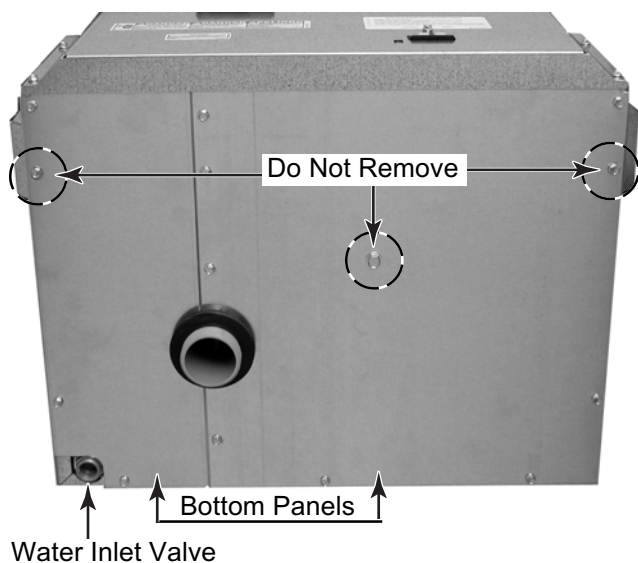

5. Disconnect the water hose from the water inlet valve.
6. Remove the two water inlet valve bracket screws and remove the valve assembly.

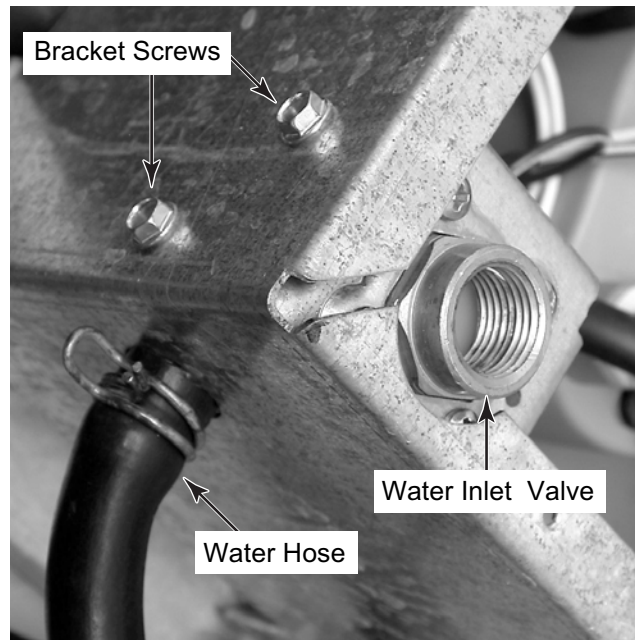

7. Disconnect the two wire connectors from the water inlet valve solenoid terminals.
8. Remove the four mounting screws from the water inlet valve and remove it.

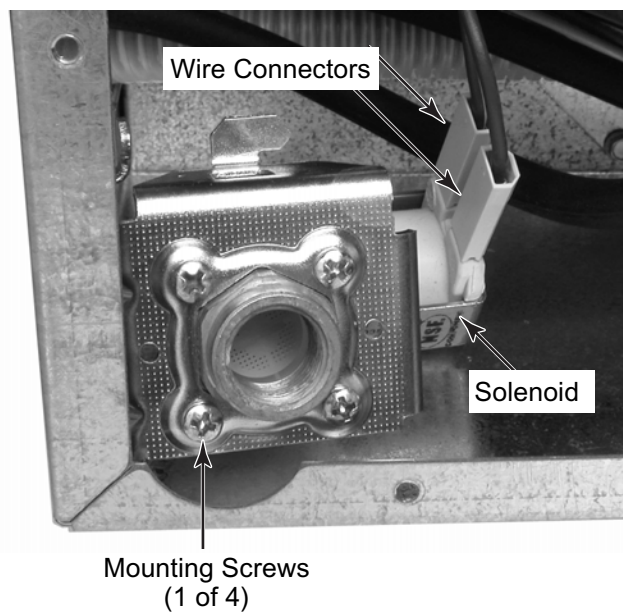

# REMOVING THE THERMISTOR

## ⚠ WARNING



### Electrical Shock Hazard

Disconnect power before servicing.

Replace all parts and panels before operating.

Failure to do so can result in death or electrical shock.

1. Unplug dishwasher or disconnect power.
2. Except for the indicated three screws, remove the remaining screws from the two bottom panels and remove the panels from the dishwasher.

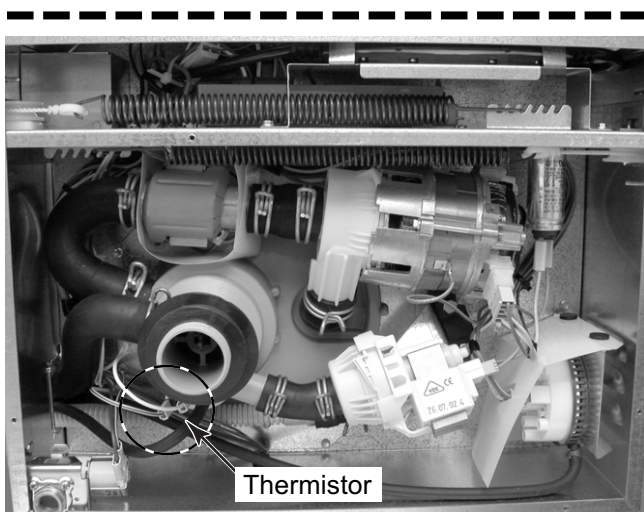
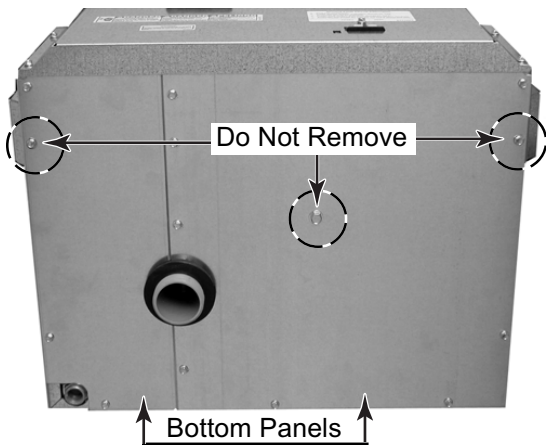

3. Disconnect the two wire connectors from the thermistor terminals.



Thermistor Wire Connectors

4. Turn the thermistor 90° counterclockwise and remove it.

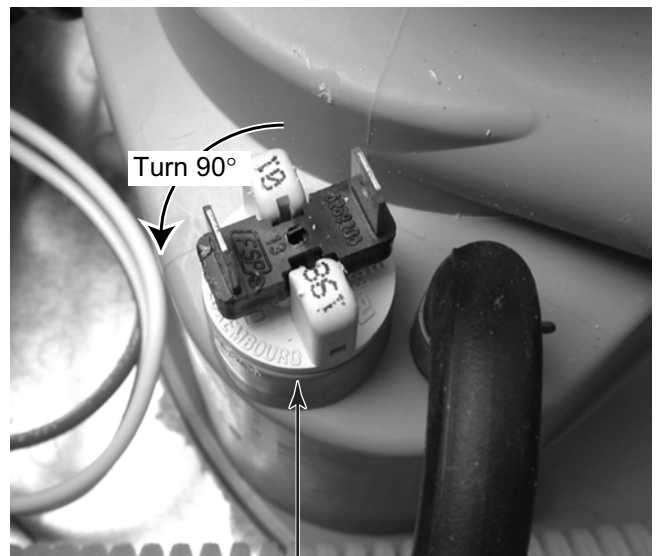

Thermistor

## REMOVING THE DRAIN PUMP

### **!WARNING**



**Electrical Shock Hazard**  
**Disconnect power before servicing.**  
**Replace all parts and panels before operating.**  
**Failure to do so can result in death or electrical shock.**

1. Unplug dishwasher or disconnect power.
2. Remove the two panels from the bottom of the dishwasher (see step 2 on page 4-14).

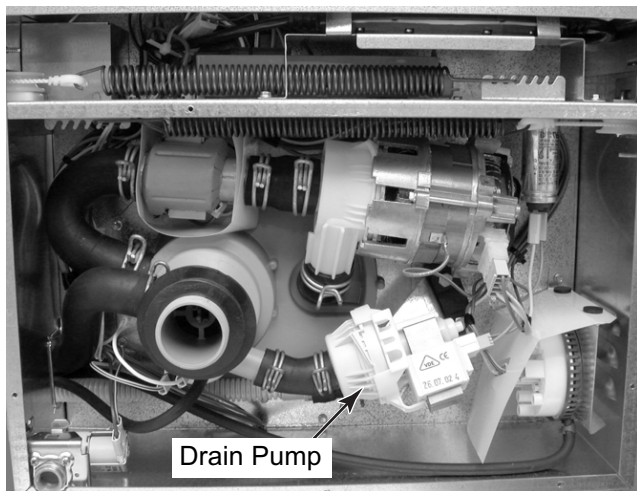

- Refer to the photo at the top of the right column.
3. Disconnect the wire connector from the drain pump terminals.
  4. Loosen the drain pump-to-ump hose clamp.
  5. Remove the two 7/16" mounting bolts from the rubber mount.

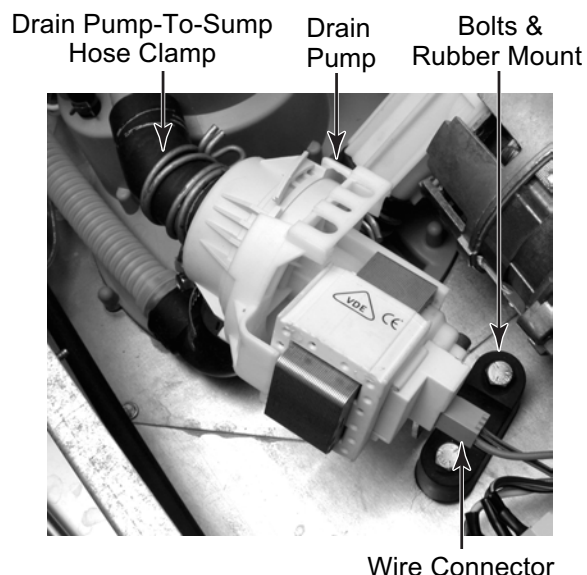

6. Pull the drain pump and pump-to-ump hose off the sump connector.
7. Disconnect the air gap hose from the drain pump.

Sump Connector Pull Drain Pump & Hose Off Sump

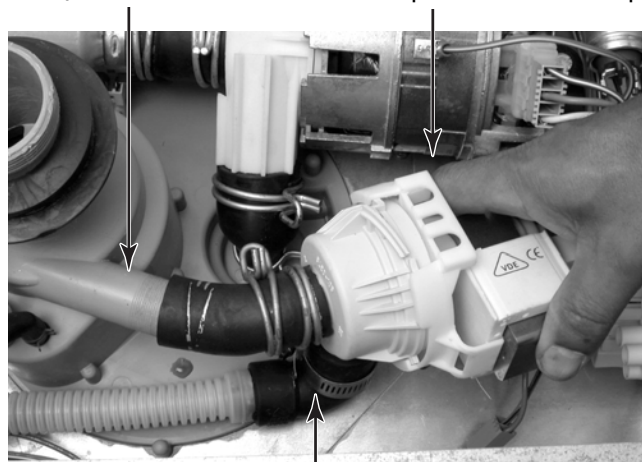

Air Gap Hose

8. Remove the drain pump-to-ump hose from the drain pump and remove the rubber mount from the pump bracket.

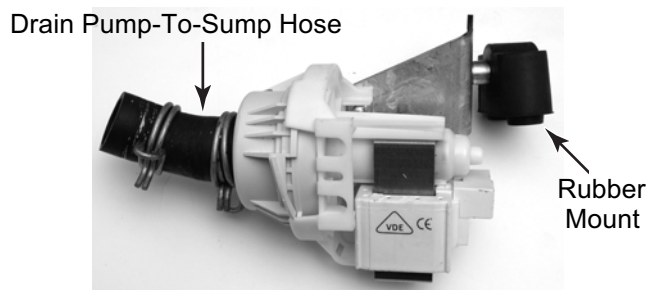

# REMOVING THE WASH PUMP MOTOR AND INLINE HEATER

## ⚠️ WARNING



### Electrical Shock Hazard

Disconnect power before servicing.

Replace all parts and panels before operating.

Failure to do so can result in death or electrical shock.

1. Unplug dishwasher or disconnect power.
2. Remove the two panels from the bottom of the dishwasher (see step 2 on page 4-14).

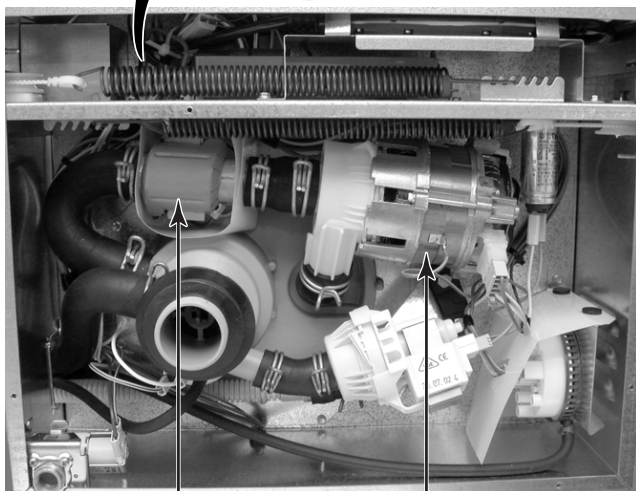
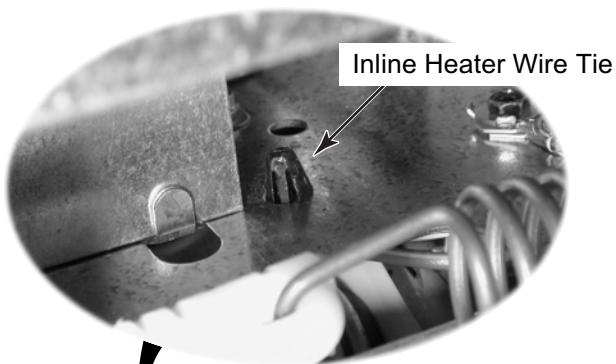

Inline Heater

Wash Pump Motor

3. Disconnect the power connector and green ground wire connector from the wash pump motor terminals.
4. Unclip the wire tie that is around the inline heater wires from the chassis hole (see the oval inset in the photo in the left column).
5. Remove the wash pump-to-sump hose at the pump.
6. Remove the inline heater-to-sump hose at the sump.
7. Remove the two 7/16" bolts from the wash pump motor rubber mount.

Inline Heater-To-Sump Hose

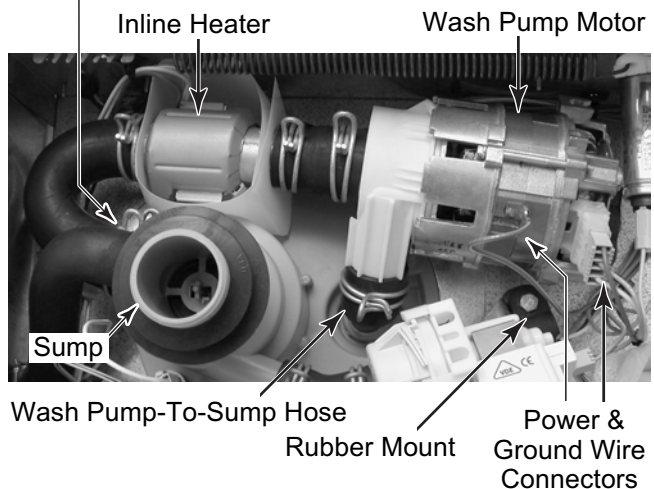

8. Lift the wash pump motor and inline heater out of the unit as an assembly, and disconnect the 3-wire inline heater connector from the harness.

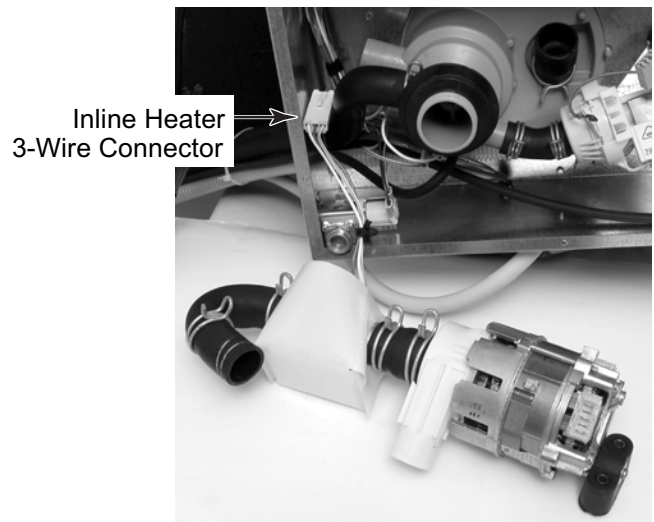

9. Set the wash pump motor and inline heater assembly on a work surface.
10. Remove the inline heater from the wash pump motor hose, then remove the remaining hose and the moisture shield from the inline heater.
11. Disconnect the remaining hose from the wash pump motor.

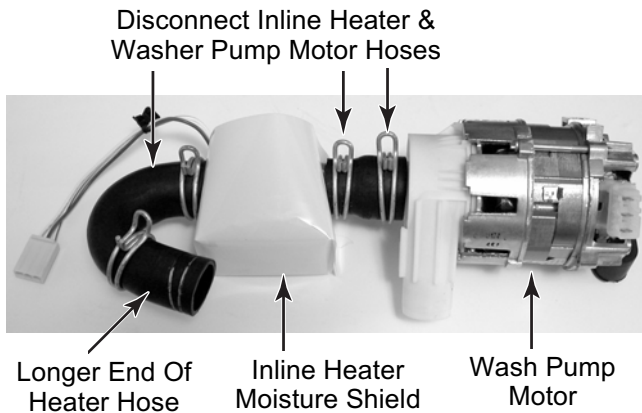

12. Disconnect the white, white-red, and green wire connectors from the inline heater terminals.

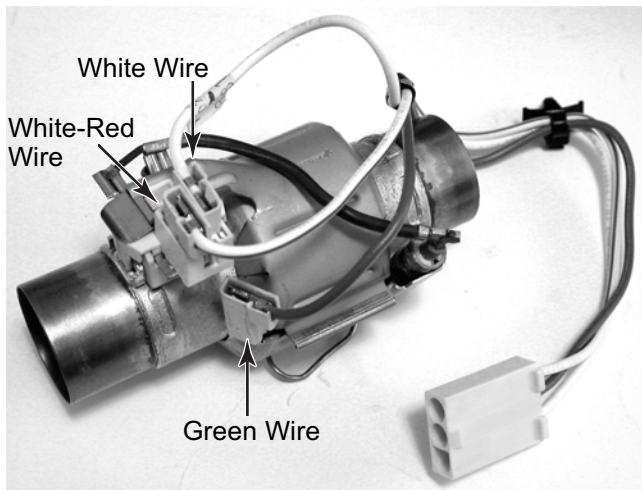

**REASSEMBLY NOTES:**

- Make sure that you position the inline heater in the assembly with the wire connectors facing the top of the unit and the moisture shield opening facing down, as shown. Route the wires down so the wire post can be inserted into the hole in the chassis.
- Position the curved hose so the shorter end is at the inline heater, and the longer end is at the sump (see photo at top of left column).

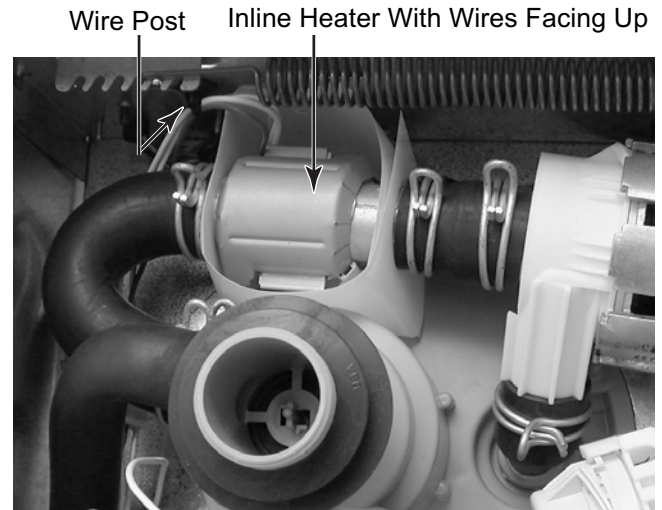

## REMOVING THE SUMP

### **!WARNING**



#### **Electrical Shock Hazard**

**Disconnect power before servicing.**

**Replace all parts and panels before operating.**

**Failure to do so can result in death or electrical shock.**

1. Unplug dishwasher or disconnect power.
2. Open the dishwasher lid.
3. Remove the loading rack (see page 4-2 for the removal and proper installation of the loading rack).
4. Remove the drain filter assembly, the microfilter, and sieve from the dishwasher (see page 4-3 for the procedure).
5. Remove the poppet cover and poppet (see page 4-4 for the procedure).
6. Remove the four T-15 Torx screws from the top of the sump.

Top Sump Mounting Screw (1 of 4)

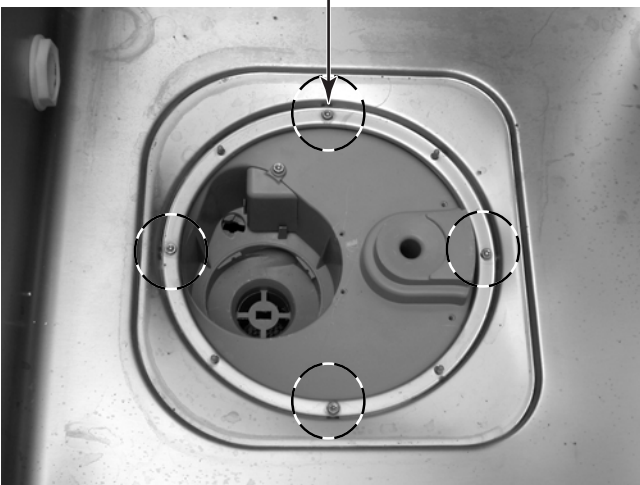

7. Disconnect the house drain line from the sump.
8. Remove the two panels from the bottom of the dishwasher (see step 2 on page 4-14).

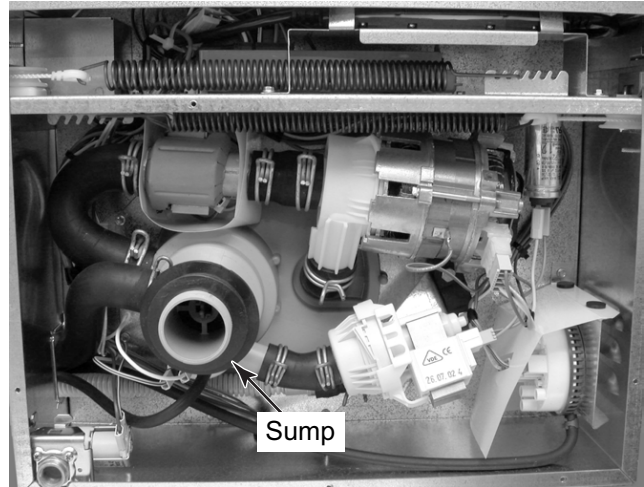

9. Remove the thermistor from the sump (see page 4-14 for the procedure).
10. Remove the drain pump (see page 4-15 for the procedure).
11. Remove the wash pump motor and inline heater as an assembly (see page 4-16 for the procedure).
12. Remove the rubber gasket from the sump drain.



Rubber Gasket

13. Remove the pressure switch hose from the sump.
14. Remove the eight 1/4" hex-head screws from the metal collar that is around the sump, and remove the sump from the bottom of the dishwasher.

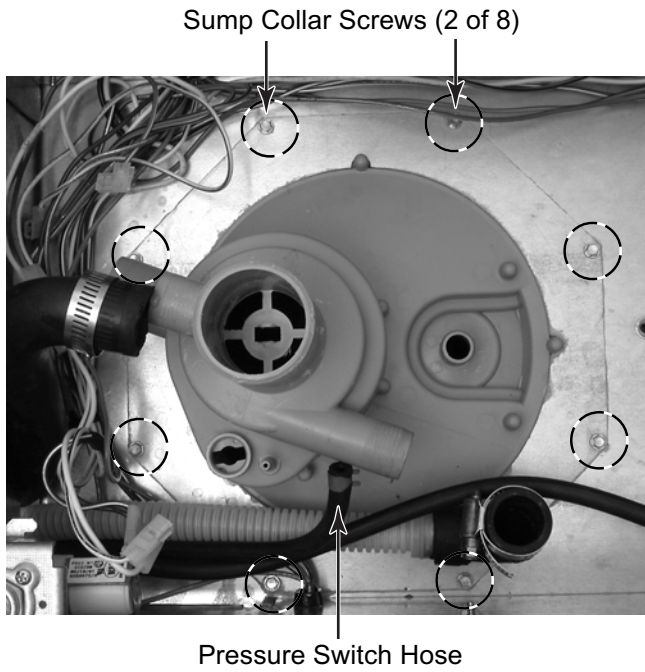

**REASSEMBLY NOTE:** Install a new sump gasket when you install the sump in the dishwasher.

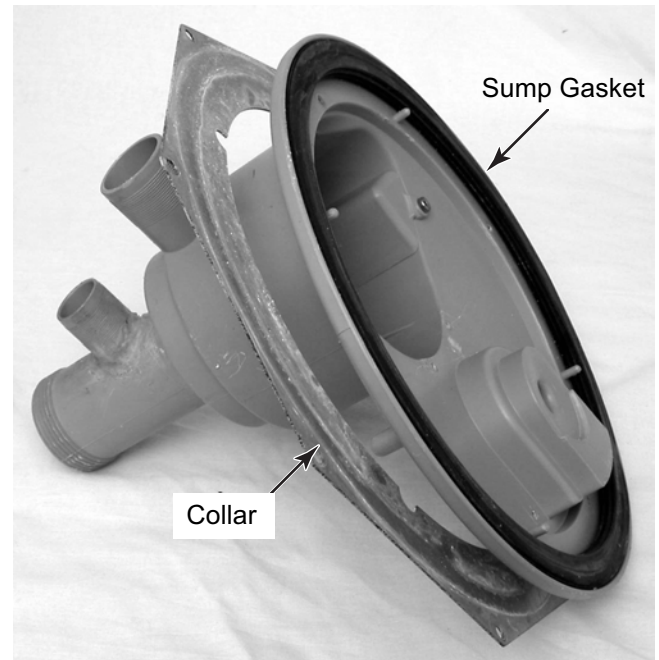

## REMOVING THE PRESSURE SWITCH

### **!WARNING**



#### **Electrical Shock Hazard**

**Disconnect power before servicing.**

**Replace all parts and panels before operating.**

**Failure to do so can result in death or electrical shock.**

1. Unplug dishwasher or disconnect power.
2. Remove the two panels from the bottom of the dishwasher (see step 2 on page 4-14).

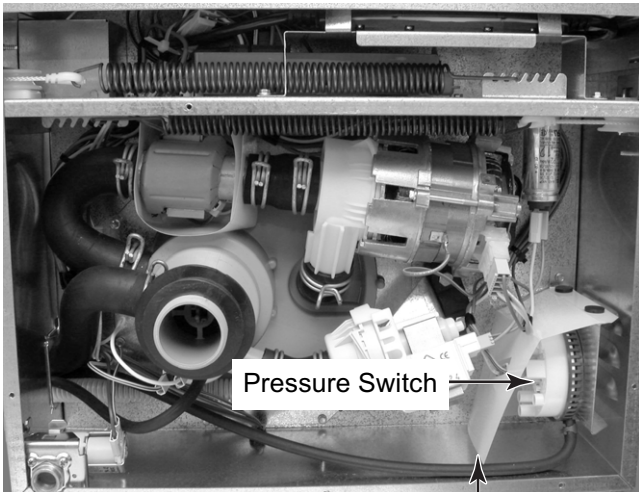

Moisture Shield

3. Disconnect the wire connector from the pressure switch terminals.

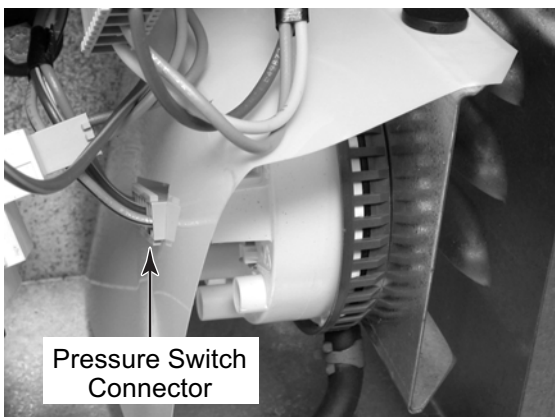

4. Lift the bottom of the moisture shield so it is up and out of the way.
5. Rotate the pressure switch counterclockwise so you can easily access the pressure hose, and disconnect the hose from the switch.
6. Rotate the pressure switch a full 90° counterclockwise, and align the square key with the cutout, then remove the switch from the mounting bracket.

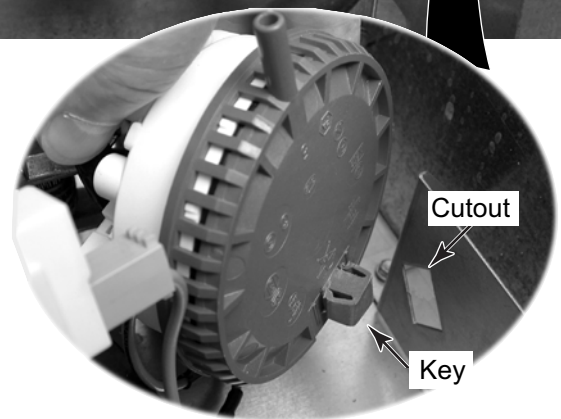
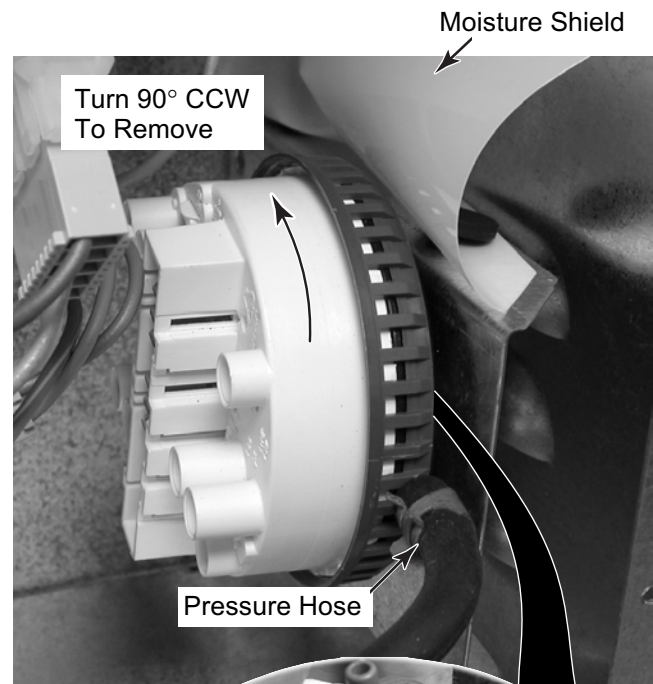



# REMOVING THE WASH PUMP MOTOR CAPACITOR

## ⚠️ WARNING



**Electrical Shock Hazard**  
**Disconnect power before servicing.**  
**Replace all parts and panels before operating.**  
**Failure to do so can result in death or electrical shock.**

1. Unplug dishwasher or disconnect power.
2. From under the sink, remove the five screws from the front panel and remove the panel.

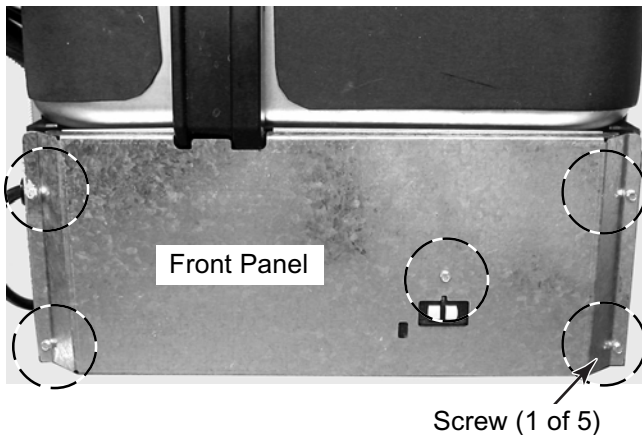

3. Remove the wash pump motor capacitor mounting nut from the chassis.

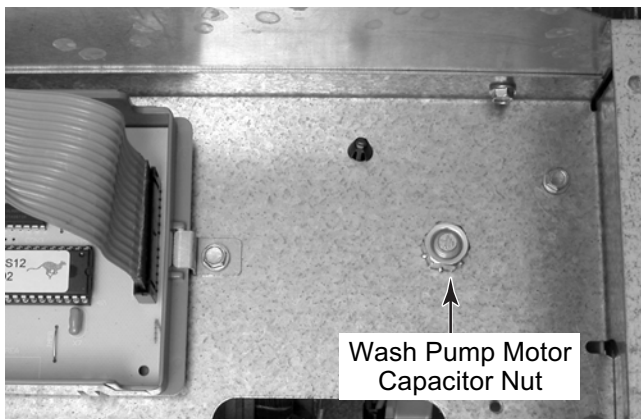

4. Remove the two panels from the bottom of the dishwasher (see step 2 on page 4-14).

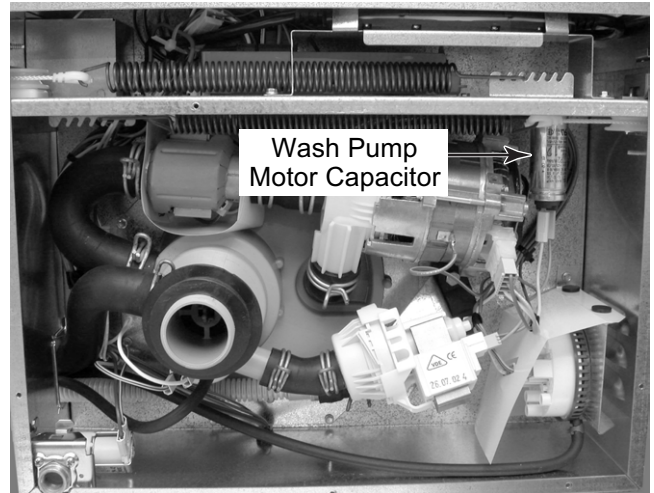

5. Use a screwdriver with an insulated handle and short the wash pump motor capacitor terminals to ground to discharge the capacitor. NOTE: Touch the screwdriver first to ground, and then to the capacitor terminals.
6. Disconnect the wire connectors from the wash pump motor capacitor terminals.

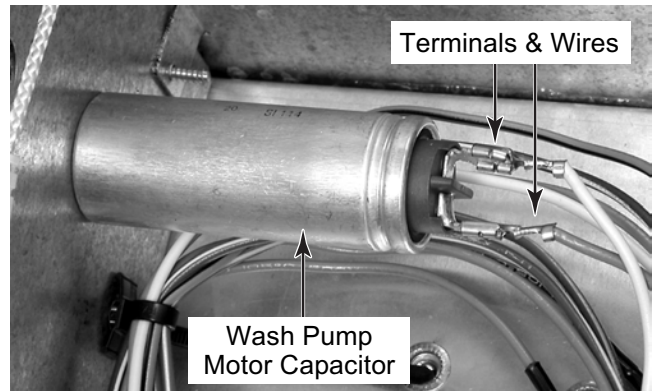

# REMOVING THE DISHWASHER LID AND THE LINKAGE COMPONENTS

## ⚠️ WARNING



### Electrical Shock Hazard

Disconnect power before servicing.  
Replace all parts and panels before operating.

Failure to do so can result in death or electrical shock.

1. Unplug dishwasher or disconnect power.
2. Remove the two panels from the bottom of the dishwasher (see step 2 on page 4-14).
3. Raise the dishwasher lid and prop it up to keep it from falling during the removal procedure. This will relieve some of the spring tension from the linkage.

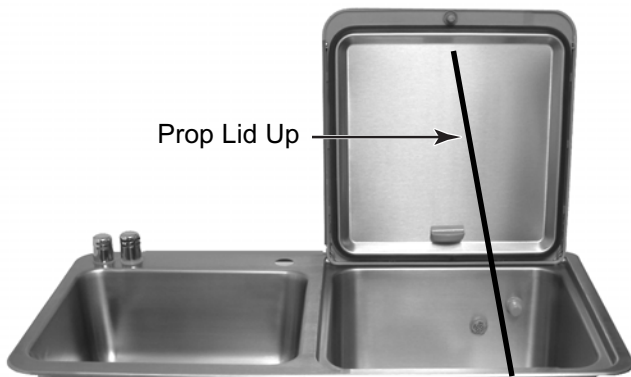

4. To remove the dishwasher lid:
  - a) Mark the notch locations on the tension brackets for each lid tension spring, and then unclip the ends of the springs.

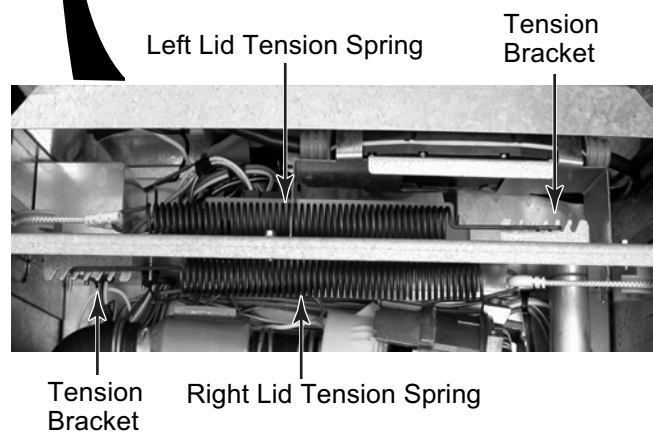
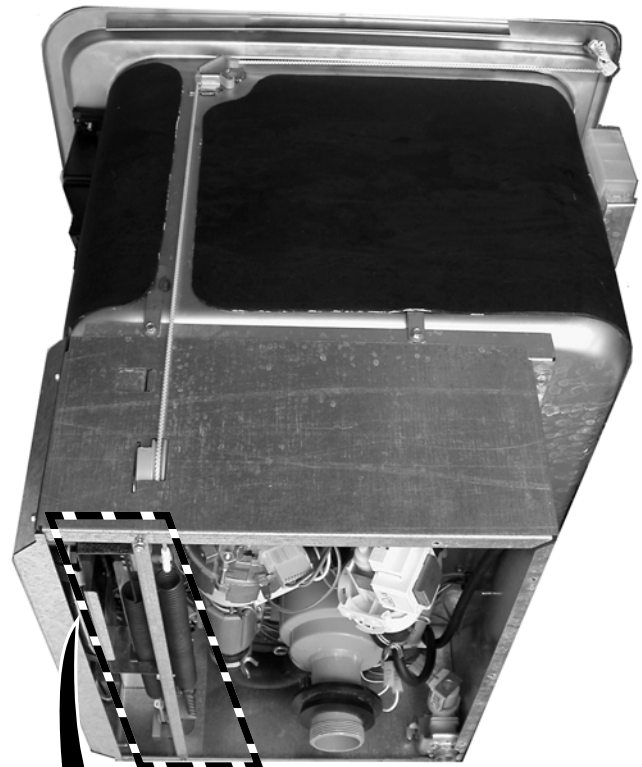

- b) Remove the screws from each of the dishwasher lid hinges and remove the lid from the dishwasher.



- b) Remove the two mounting screws from the lower guide and remove the guide (the lower left guide screws are shown below). NOTE: If you are removing the lower right guide, you will have to remove the front panel to access the screws (see step 2 on page 4-21 for the procedure).

- c) Unhook the spring, and pull the end of the linkage cord through the opening for the lower guide.

- d) Remove the lid hinge screws for the linkage cord you are removing, and remove the hinge from the top of the dishwasher (see the photo to the left).

**5. To remove the left or right linkage cord and a lower guide:**

- a) Unhook the lid tension spring for the linkage component (left or right) you are removing (see step 4 on the previous page for the procedure).

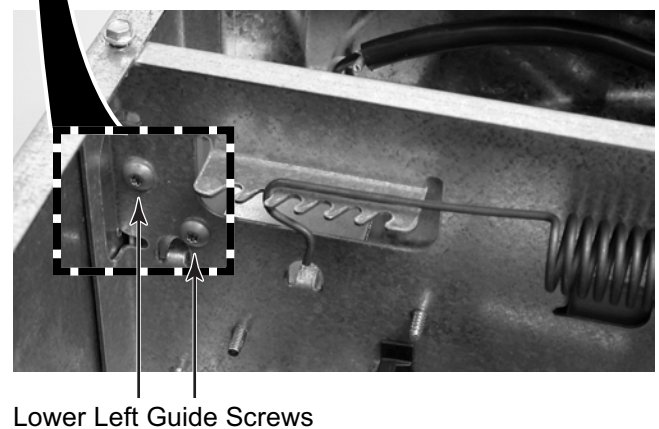
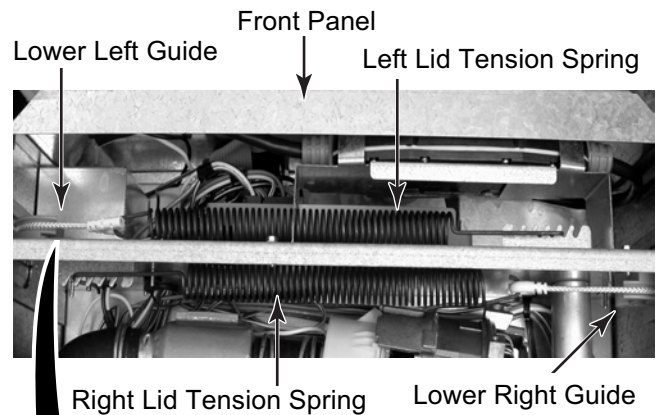
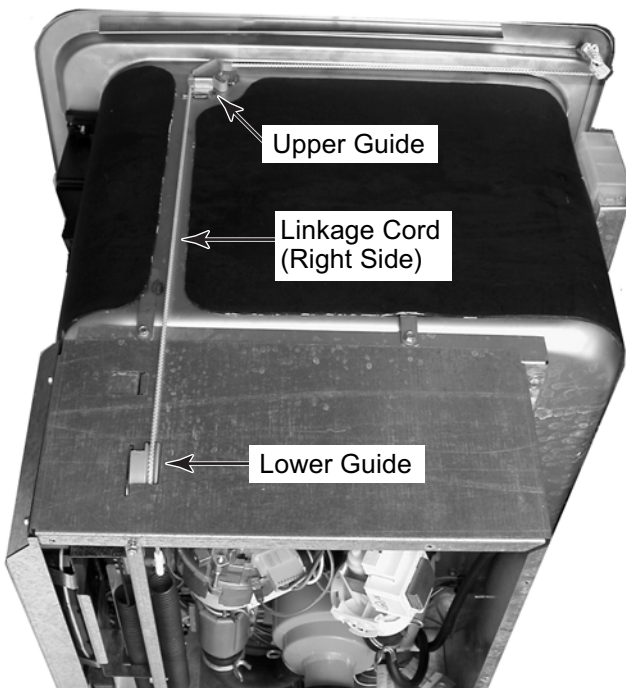

**Continued on the next page.**

- e) **To remove an upper guide**, (see the photo in step 5 on page 4-23 for the guide location), pry out on the locking tab with a screwdriver, and pull the guide out of the holder.

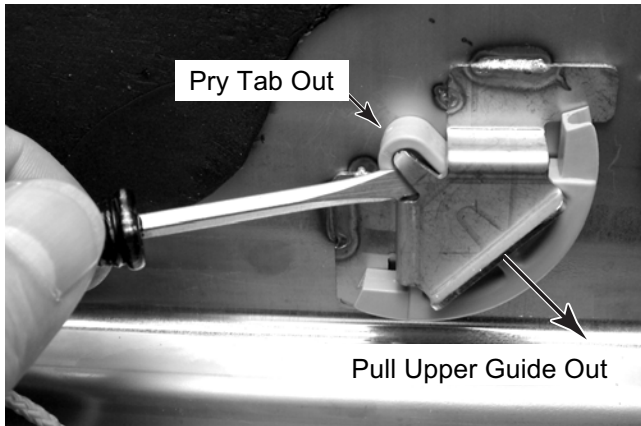

**REASSEMBLY NOTE:** After servicing the dishwasher lid, open and close the lid to make sure that it operates normally.

The door should just "pop open" when the latch is released. If it opens further, reduce the spring tension by moving the end of the spring in the spring tension bracket notches (see the photo below).

With the lid open all the way, it should stay open. If it begins to close, increase the spring tension.

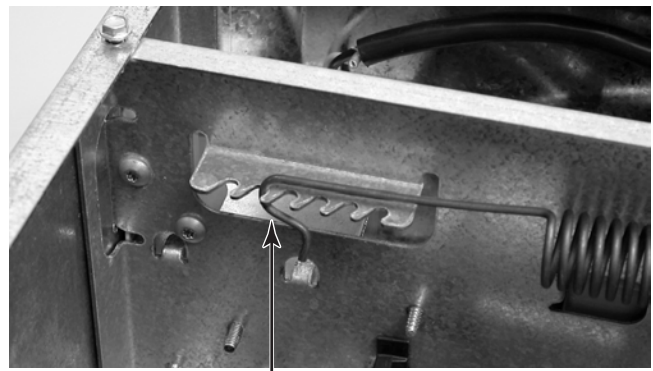

Spring Tension Bracket

# REMOVING THE DISHWASHER LID ACTUATOR

1. Raise the dishwasher lid.
2. Loosen the lid actuator knob setscrew and remove the knob.
3. Remove the hex nut, e-ring, and flat washer from the cam shaft, and remove the star washer, bushing/collar, torsion spring, and the cam & shaft assembly from the lid.
4. Rotate the spring until the lower hook engages the stop inside the cam.
5. Keep the collar engaged with the spring and rotate the collar counterclockwise until the collar drops into position on the cam. The actuator assembly must be held together to keep the spring from unwinding. When properly assembled, the cam and shaft can be manually rotated 90°, and the spring will return it to its original position.

## REASSEMBLY NOTE:

To reassemble the lid actuator:

1. Place the star washer onto the bushing/collar, and carefully slide the assembly into the lid opening so that the key in the assembly fits into the cutout in the bottom of the lid.
2. Hold the actuator assembly in place, and slide the flat washer and hex nut over the bushing and hand tighten the nut.
3. Hold the cam and shaft assembly in the vertical position with the shaft pointing up, and slide the torsion spring over the shaft.
6. Make sure that the hex nut is far enough down onto the bushing to fully expose the e-ring slot, and snap the e-ring into place on the bushing.
7. Align the actuator assembly with the hole in the lid and tighten the hex nut.
8. Reinstall the knob and tighten the set-screw securely.

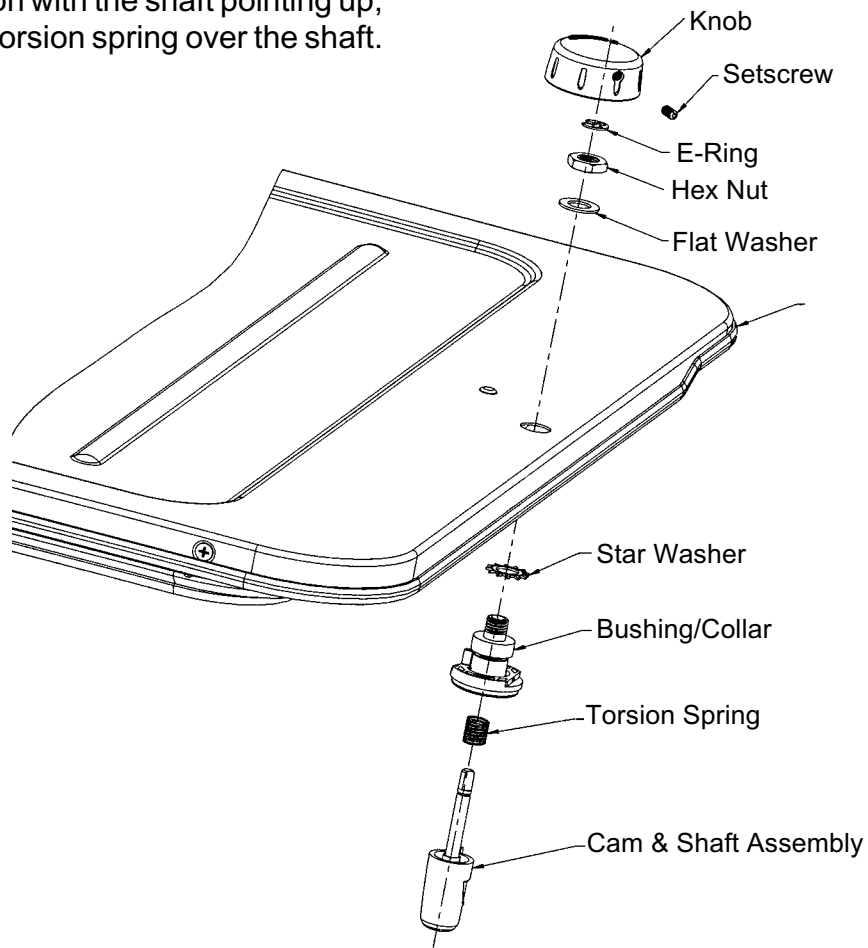

— NOTES —

# COMPONENT TESTING

Before testing any of the components, perform the following checks:

- Control failure can be the result of corrosion on connectors. Therefore, disconnecting and reconnecting wires will be necessary throughout test procedures.
- All tests/checks should be made with a VOM or DVM having a sensitivity of 20,000 ohms-per-volt DC, or greater.
- Check all connections before replacing components, looking for broken or loose wires, failed terminals, or wires not pressed into connectors far enough.
- Resistance checks must be made with power cord unplugged from outlet, and with wiring harness or connectors disconnected.



## ⚠ WARNING

### Electrical Shock Hazard

**Disconnect power before servicing.  
Replace all parts and panels before operating.  
Failure to do so can result in death or electrical shock.**

## DISPENSER LEVEL SWITCH

Refer to page 4-6 for the procedure for servicing the dispenser level switch.

1. Unplug dishwasher or disconnect power.
2. Position the empty dispenser tank with the level switch facing down.
3. Disconnect one of the wires from the level switch terminals.
4. Set the ohmmeter to the R x 1 scale.
5. Touch the ohmmeter test leads to the dispenser level switch terminals. The meter should indicate continuity ( $0 \Omega$ ).
6. Position the dispenser tank with the level switch facing up.
7. Touch the ohmmeter test leads to the dispenser level switch terminals. The meter should indicate an open circuit (infinite).

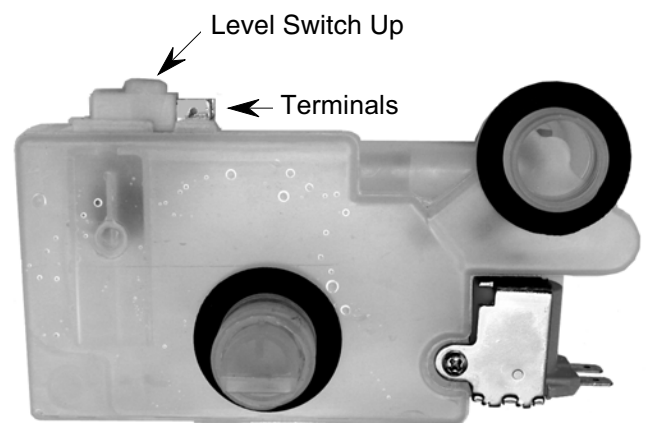
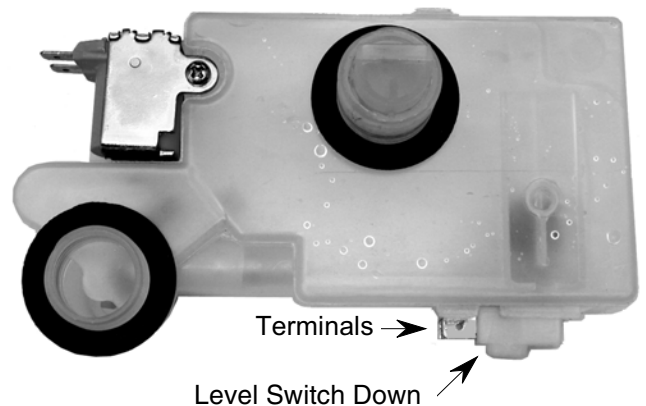



## ⚠️ WARNING

### Electrical Shock Hazard

**Disconnect power before servicing.**

**Replace all parts and panels before operating.**

**Failure to do so can result in death or electrical shock.**

### RINSE AGENT SOLENOID

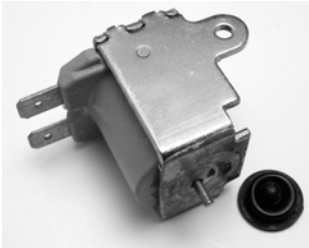

Refer to page 4-6 for the procedure for servicing the rinse agent solenoid.

1. Unplug dishwasher or disconnect power.
2. Disconnect one of the wires from the rinse agent solenoid terminals.
3. Set the ohmmeter to the R x 100 scale.
4. Touch the ohmmeter test leads to the rinse agent solenoid terminals. The meter should indicate between 285 and 315  $\Omega$ .

### INTERLOCK SWITCH



Refer to page 4-8 for the procedure for servicing the interlock switch.

1. Unplug dishwasher or disconnect power.
2. Disconnect one of the wires from the interlock switch terminals.
3. Set the ohmmeter to the R x 1 scale.
4. Touch the ohmmeter test leads to the interlock switch terminals. The meter should indicate continuity (0  $\Omega$ ).
5. Press on the interlock switch actuator button, and the meter should indicate an open circuit (infinite)





## ⚠️ WARNING

### Electrical Shock Hazard

**Disconnect power before servicing.**

**Replace all parts and panels before operating.**

**Failure to do so can result in death or electrical shock.**

### WAX MOTOR



Refer to page 4-8 for the procedure for servicing the wax motor.

1. Unplug dishwasher or disconnect power.
2. Disconnect one of the wires from the wax motor terminals.
3. Set the ohmmeter to the R x 100 scale.
4. Touch the ohmmeter test leads to the wax motor terminals. The meter should indicate between 600 and 1800  $\Omega$ .

### WATER INLET VALVE SOLENOID

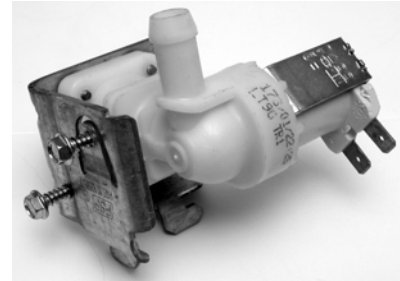

Refer to page 4-13 for the procedure for servicing the water inlet valve.

1. Unplug dishwasher or disconnect power.
2. Disconnect one of the wires from the water inlet valve solenoid terminals.
3. Set the ohmmeter to the R x 100 scale.
4. Touch the ohmmeter test leads to the water inlet valve solenoid terminals. The meter should indicate between 890 and 1090  $\Omega$ .



## ⚠️ WARNING

### Electrical Shock Hazard

**Disconnect power before servicing.  
Replace all parts and panels before operating.  
Failure to do so can result in death or electrical shock.**

## THERMISTOR



Refer to page 4-14 for the procedure for servicing the thermistor.

1. Unplug dishwasher or disconnect power.
2. Disconnect one of the wires from the thermistor terminals.
3. Set the ohmmeter to the R x 100 scale.
4. Touch the ohmmeter test leads to the thermistor terminals. The meter should indicate as follows:

47 to 53 k $\Omega$  @ 25°C/77°F

12 to 13 k $\Omega$  @ 60°C/140°F

## DRAIN PUMP



Refer to page 4-15 for the procedure for servicing the drain pump.

1. Unplug dishwasher or disconnect power.
2. Disconnect the wire connector from the drain pump terminals.
3. Set the ohmmeter to the R x 1 scale.
4. Touch the ohmmeter test leads to the drain pump terminals. The meter should indicate between 20 and 30  $\Omega$ .



## ⚠️ WARNING

### Electrical Shock Hazard

**Disconnect power before servicing.**

**Replace all parts and panels before operating.**

**Failure to do so can result in death or electrical shock.**

## WASH PUMP MOTOR



Refer to page 4-16 for the procedure for servicing the wash pump motor.

1. Unplug dishwasher or disconnect power.
2. Disconnect the wire connector from the wash pump motor terminals.
3. Set the ohmmeter to the R x 1 scale.
4. Touch the ohmmeter test leads to indicated wash pump motor terminals. The meter should indicate as follows:

Terminal Number	Reading
1 & 2	5 to 9 $\Omega$
2 & 3	26 to 34 $\Omega$
1 & 3	15 to 25 $\Omega$

## INLINE HEATER

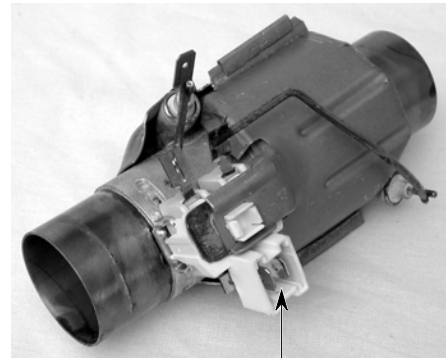

Terminals

Refer to page 4-16 for the procedure for servicing the inline heater.

1. Unplug dishwasher or disconnect power.
2. Disconnect the wire connector from the inline heater terminals.
3. Set the ohmmeter to the R x 1 scale.
4. Touch the ohmmeter test leads to the inline heater terminals. The meter should indicate between 14 and 16  $\Omega$ .



## ⚠️ WARNING

### Electrical Shock Hazard

**Disconnect power before servicing.**

**Replace all parts and panels before operating.**

**Failure to do so can result in death or electrical shock.**

## PRESSURE SWITCH

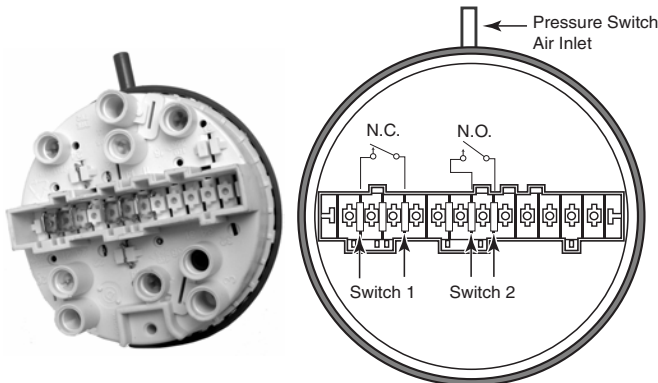

Refer to page 4-20 for the procedure for servicing the pressure switch.

1. Unplug dishwasher or disconnect power.
2. Disconnect the wire connector from the pressure switch terminals.
3. Set the ohmmeter to the R x 1 scale.
4. Touch the ohmmeter test leads to the switch 1 terminals (brn/wht & blu/blk wires). The meter should indicate a closed circuit ( $0 \Omega$ ).
5. Touch the ohmmeter test leads to the switch 2 terminals (wht & org wires). The meter should indicate an open circuit (infinite).
6. Repeat steps 4 and 5 while blowing into the pressure switch air inlet. The readings should switch (step 4 = open, step 5 closed).

## WASH PUMP MOTOR CAPACITOR



Refer to page 4-21 for the procedure for servicing the wash pump motor capacitor.

1. Unplug dishwasher or disconnect power.
2. Disconnect the wire connectors from the wash pump motor capacitor terminals.
3. Set the ohmmeter to the R x 1K scale.
4. Touch the ohmmeter test leads to the wash pump motor capacitor terminals. The meter should increase sharply, and then slowly decrease.

# DIAGNOSIS & TROUBLESHOOTING

## DIAGNOSTICS CYCLE TIME CHART

Refer to the chart on the next page.

### **R/A SENSOR ASSEMBLY CHECK**

To help detect a failed or misconnected “Rinse Aid” level sensor, the control should operate the “Rinse Aid Empty” LED in Diagnostics as it does during any other cycle.

### **THERMISTOR OPEN/SHORT DETECTION**

The Diagnostics Test Cycle will illuminate the “CLEAN” LED and “WATER HEATING” LED. It lights throughout the operating portion of the cycle that follows the initial display test interval whenever it detects a “short circuit,” or “open circuit” on the thermistor input.

NOTE: Warm water must be in the dishwasher when performing this test. The highest thermistor resistance values the control can detect as its open circuit criteria are close to the normal thermistor resistances at room temperature. Consequently, this indicator is only reliable for “open circuit” detection if warm water is in the dishwasher.

As a means of testing the accuracy of the thermistor circuit, the control will turn on the “SANITIZED/SANI COMPLETE” LED in “Interval 3” of the Diagnostics when it detects a thermistor resistance of 10 kΩ.

### **STUCK PRESSURE SWITCH DETECTION**

The Diagnostics Test Cycle will illuminate the “SENSING/SOAKING” LED throughout the operating portion of the cycle that follows the initial display test interval whenever it detects an “open circuit” on the pressure switch (soil sensor) input. The Diagnostics Cycle also monitors the normally-open soil-sensing pressure switch input for a “stuck open” condition by aborting wash “Interval 3,” and skipping immediately to drain “Interval 1” if the control detects an open pressure switch.

### **DISPLAY TEST**

All LEDs, regardless of function, are turned On during the first interval of the Diagnostics Cycle as a “Display Test.” All LEDs should light, and all segments of any time display should light. If any LED does not turn On, there is an open circuit in the keypad, and the console assembly/keypad should be replaced.

### **DIAGNOSTICS CYCLES**

Pressing the following option keys in the sequence shown will start the Diagnostics Test Cycle:

RINSE ONLY  
SANI RINSE  
RINSE ONLY  
SANI RINSE

Once Diagnostics Cycle is started, the cycle can be rapid advanced to the next interval manually by pressing the “Start” key, or the “Pots & Pans” key. NOTE: The door lid must be latched after each key press to advance to the next interval.

### **RAPID ADVANCE SERVICE FEATURE**

To turn on the “Rapid Advance Service Feature,” start the desired cycle, and then press and hold the “Start” key for 5 seconds. Once “Rapid Advance” is turned On, the cycle can be rapid advanced manually, one interval at a time, by pressing the “Start” key, or the “Pots & Pans” key. NOTE: The door lid must be latched after each key press to advance to the next interval.

INTERVAL	12	11	10	9	8	7	6	5	4	3	2	1	
<b>CYCLE LEDs</b>													S
POTS & PANS	█												T
NORMAL	█	█		█		█		█		█			A
QUICK	█												N
RINSE ONLY	█		█		█		█		█		█	█	D
CANCEL DRAIN	█												B
													Y
<b>OPTION LEDs</b>													
SANI RINSE	█												
DELAY - 4 HR	█												
<b>CYCLE PROG / STATUS LEDs</b>													
RINSE AID EMPTY	█	█	█	█	█	█	█	█	█	█	█	█	
LOCKOUT	█												S
W1	█												T
WASHING (W2)	█								█		█	█	A
R1	█												N
CIRC (R2)	█				█		█		█		█	█	D
RINSING	█				█		█						B
DRAIN OPEN	█												Y
SENSING	█	█	█	█	█	█	█	█	█	█	█	█	
ADD-A-DISH	█												
WATER HEATING	█	█	█	█	█	█	█	█	█	█	█	█	
SANI COMPLETE	█								█				
CLEAN	█	█	█	█	█	█	█	█	█	█	█	█	
<b>NUMERIC DISPLAY</b> (Software identification in intervals 10 and 11).	88	"d2"	"d2"	9	8	7	6	5	4	3	2	1	
<b>INTERVAL TIME (min/sec)</b>	0:03	0:05	0:02	0:05	0:10	0:02	0:05	0:02	1:00	0:05	0:25	1:30	
<b>AUTOMATED SENSOR CHECKS (LOAD CHANGES)</b>													
<b>PRESSURE SWITCH</b> Skip immediately to start of INTERVAL 1 if detect Pressure Switch OPEN.									→				
<b>LOADS</b>													
VENT				█	█	█	█	█	█	█	█	█	S
FILL					█								T
WASH MOTOR									█	█			A
DETERGENT / RINSE AID DISPENSER							█						N
LID ACTUATOR												█	D
DRAIN MOTOR										█	█		B
HEATER	█												Y

# CHECKING THE KEYPAD AND KEYSWITCH OPERATION

## CHECKING KEYPAD OPERATION

Check the keypad ribbon tail for:

- Broken, shorted, corroded, or creased traces.
- Loose connection to the control.
- Contaminants or corrosion around the perimeter of the keypad, on the keypad or the ribbon tail, or the keypad connector at the control.

To test an LED function, confirm that the LED turns On during the “Display Test” at the beginning of the Diagnostics Cycle (refer to the “Diagnostics Cycle Time Chart” on pages 6-1 and 6-2).

## CHECKING THE KEYSWITCH CONTACTS

Before checking the keyswitches:

- Disconnect power to the dishwasher.
- Unplug the ribbon cable at connector P1 on the control board.

Using the table below, measure the resistance across the switch when the key is pressed. NOTE: The ohmmeter must be connected with the proper polarity.

**If you are using an analog meter**, the resistance reading should go from infinity (open circuit) down to a readable resistance level. The level may be different, depending on your meter, since there is a diode in the circuit.

**If you are using a digital meter**, the resistance reading should go from infinity (open circuit) down to a readable resistance level. The level may be different, depending on your meter, since there is a diode in the circuit. If available, you can use the “diode test” function of the meter, which will supply a voltage of about 1.2 VDC during the test.

If any switches fail the test, replace the console panel/keypad assembly.

If all of the switches test okay, replace the control board.

KEYSWITCH RESISTANCE CHECK TABLE			
	KEY	(+) Pos. Lead	(-) Neg. Lead
SW1	CANCEL	P1-12	P1-2
SW2	(NOT USED)	P1-13	P1-2
SW3	(NOT USED)	P1-11	P1-3
SW4	DELAY	P1-12	P1-3
SW5	(NOT USED)	P1-13	P1-3
SW6	(NOT USED)	P1-11	P1-4
SW7	START	P1-12	P1-4
SW8	POTS & PANS	P1-13	P1-4
SW9	SANI RINSE	P1-11	P1-5
SW10	RINSE ONLY	P1-12	P1-5
SW11	NORMAL	P1-13	P1-5
SW12	(NOT USED)	P1-11	P1-6
SW13	(NOT USED)	P1-12	P1-6
SW14	(NOT USED)	P1-13	P1-6

# NORMAL CYCLE OPERATION CHART

CYCLE NAME	CYCLE SEQUENCE (and temperature of water heating pauses / thermal holds where present)	CYCLE TIME (without thermal holds)
<b>NORMAL</b>	Pre-Cycle Drain ⇌ Main Wash (145°F / 62°C) ⇌ Rinse ⇌ Purge ⇌ Rinse ⇌ Final Rinse (145°F / 62°C) ⇌ Open Lid (Air Dry)	26:53 min.
	Sani Rinse Option: • Raises Final Rinse to 160° F / 71° C. • Adds 2:00 min. to Final Rinse between the thermal hold and rinse aid dispense interval.	
<b>OPERATION OF LOADS</b>	“Vent” / Power Bus	Energized to provide power bus to small loads from the beginning of the cycle to the end of the cycle.
	Lid Actuator	Energized after the final rinse thermal hold through the end of the cycle. Engages door latch release mechanism that opens the door lid when actuator turns off at the end of the cycle.
	Fill	Energized at the beginning of the Main Wash (0:52sec.), all rinses, and the purge (0:44 sec. each).
	Wash Motor	Energized in middle of the Main Wash and all rinses.
	Dispenser (Rinse Aid)	Energized after the final rinse thermal hold (1:00 min.).
	Drain Motor	Energized (for minimum of 10 seconds and up to 8:10 min.) to assure sink is empty before running a cycle. Also energized at end of Main Wash, all rinses, and the purge (0:30 sec. each).
	Heater	Energized during Main Wash and all thermal holds.
	Final Rinse Thermal Hold	Occurs after the fill and pause intervals at the beginning of the Final Rinse.



# TROUBLESHOOTING CHART

**NOTES:**

1. For “Keypad Checks,” refer to “Checking Keypad Operation” on page 6-3.
2. For “Resistance Checks,” refer to the strip circuits, starting on page 7-2.
3. For “Checking Operation With Diagnostics,” refer to “Diagnostics Cycles” on page 6-1. Also refer to “Rapid Advance Service Feature” on standard cycles on page 6-1.
4. For information on Normal cycles and options, refer to the “Normal Cycle Operation Chart” on page 6-4.

PROBLEM	POSSIBLE CAUSE	SOLUTION
Will not run or power up. - No operation - No Keypad Response - No LEDs or Display	<ol style="list-style-type: none"> <li>1. No power to unit or bad connection.</li> <li>2. Loose connections in dishwasher power up circuit or between keypad(s) and control.</li> <li>3. Door switch not making contact, due to faulty door latch assembly, or door switch.</li> <li>4. Blown TCO attached to control.</li> <li>5. Multiple open or shorted circuits in keypad.</li> <li>6. Faulty control.</li> </ol>	<ol style="list-style-type: none"> <li>1. Check the fuses, circuit breakers, and junction box connections.</li> <li>2. Check the resistance of all connections in the power up circuit to the control, and the connections between the keypad(s) and the control.</li> <li>3. Measure the resistance of the door switch contacts while checking the mechanical operation of the latch assembly. Confirm that the switches are not loose from the assembly.</li> <li>4. Measure the resistance. If open, replace the TCO. If replaced more than once, replace the harness. NOTE: Replace any component that has evidence of overheating.</li> <li>5. Check the keypad.</li> <li>6. Check the control.</li> </ol>
Will not run and LEDs are blinking.	<ol style="list-style-type: none"> <li>1. Stuck key(s) or shorted circuit(s) in keypad.</li> <li>2. Shorted circuits or connections on the control that read the keys.</li> </ol>	<ol style="list-style-type: none"> <li>1. Check the keypad.</li> <li>2. Check the control.</li> </ol>
Will not start.	<ol style="list-style-type: none"> <li>1. Door switch not making contact, due to faulty door latch assembly, or door switch.</li> <li>2. Loose connections between door switches and pin 8 on control.</li> <li>3. Control not receiving Start key (or Cycle key, if model has no Start key).</li> </ol>	<ol style="list-style-type: none"> <li>1. Measure the resistance of the door switch contacts while checking the mechanical operation of the latch assembly. Confirm the switches are not loose from the assembly.</li> <li>2. Check the resistance of all the harness connections between the door switches and pin 8 of the control.</li> <li>3. Confirm customer pressing proper key. If yes, then check keypad. If keypad okay, then check control.</li> </ol>

<b>PROBLEM</b>	<b>POSSIBLE CAUSE</b>	<b>SOLUTION</b>
Control Lock - Will not accept key presses - Control Lock LED on	<ol style="list-style-type: none"> <li>1. Control lockout feature accidentally turned on by customer.</li> <li>2. Intermittent short of Sani Rinse key, circuit in keypad, or keypad connection.</li> </ol>	<ol style="list-style-type: none"> <li>1. Press and hold the Sani Rinse key for 5 seconds to turn the "Control Lock" feature On or Off.</li> <li>2. Check the keypad.</li> </ol>
One or more keys will not respond.	<ol style="list-style-type: none"> <li>1. Open key or LED circuit(s) on the keypad.</li> <li>2. Open circuits or connections on the control that read the keys or drive LED's.</li> </ol>	<ol style="list-style-type: none"> <li>1. Check/replace keypad.</li> <li>2. Check/replace control.</li> </ol>
Unusual LED readouts.	<ol style="list-style-type: none"> <li>1. Misunderstanding of LED operation.</li> <li>2. Open ID diodes and/or LED circuit(s) in keypad.</li> <li>3. Open circuits or connections on the control that read ID's or drive LED's.</li> </ol>	<ol style="list-style-type: none"> <li>1. Instruct customer, refer to Use &amp; Care manual.</li> <li>2. Check keypad.</li> <li>3 Check control.</li> </ol>
Washes for less than 30 seconds and shuts off.	<ol style="list-style-type: none"> <li>1. Unit is in Sales Demo mode.</li> </ol>	<ol style="list-style-type: none"> <li>1. Press the following key sequence in less than 3 seconds to turn Demo mode Off (or On): Rinse Only/Sani Rinse/Sani Rinse/Rinse Only/Sani Rinse/Sani Rinse. (Note: Diagnostics will also clear Demo.)</li> </ol>
Long cycles and/or stuck in certain part of cycle.	<ol style="list-style-type: none"> <li>1. As part of normal operation, the dishwasher pauses 2 or 3 times during the cycle for thermal holds and advances once temperature is met.</li> <li>2. Low inlet water temperature.</li> <li>3 Dishwasher hooked up to cold water.</li> <li>4. Problem with temperature control devices or circuit: <ul style="list-style-type: none"> <li>• Loose connection(s).</li> <li>• Thermistor problem.</li> <li>• Problem with thermistor input on control.</li> </ul> </li> <li>5. Heater problem (either not heating water or stuck on in dry): <ul style="list-style-type: none"> <li>• Open connection or component in heater circuit.</li> <li>• Open heater.</li> <li>• Faulty heater drive circuit on control.</li> </ul> </li> </ol>	<ol style="list-style-type: none"> <li>1. Customer Instruct - explain thermal holds.</li> <li>2. Confirm temperature at sink (recommend 120°F/49°C). Instruct customer to run water at sink before running dishwasher.</li> <li>3. Confirm and correct installation if necessary.</li> <li>4. Check all components and connections in the water heating "sensing" circuit. Check resistances of all connections in thermistor circuit, resistance of thermistor, and control's ability to read thermistor in Diagnostics.</li> <li>5. Check all components and connections in the water heating "heater" circuit or the heat dry circuit. Check the resistances of all connections and components between the heater and control. Also check the resistance of the heater, and the operation of the heater in the Diagnostics cycle (confirm that it turns On and Off).</li> </ol>

PROBLEM	POSSIBLE CAUSE	SOLUTION
<p>Will not fill or water level low. The Check Drain LED is flashing.</p>	<ol style="list-style-type: none"> <li>1. No water to dishwasher.</li> <li>2. Loose connection to dishwasher fill valve or in the valve circuit.</li> <li>3. Pressure switch stuck in "over-fill" position.</li> <li>4. Open coil on fill valve solenoid.</li> <li>5. Drain stopper not in place or not secured properly.</li> <li>6. Inlet screen on fill valve plugged.</li> <li>7. Faulty fill valve drive circuit on the control.</li> <li>8. Customer perception of proper water level incorrect.</li> <li>9. Drain stopper not sealing.</li> </ol>	<ol style="list-style-type: none"> <li>1. Verify the water is turned On and the supply line adequate. Correct installation as necessary.</li> <li>2. Check resistances of all harness connections between the fill valve and the control.</li> <li>3. Verify that pressure switch contact 21 &amp; 22 are "closed." Disconnect the harness leads from the pressure switch. If there is an open circuit across 21 &amp; 22, replace pressure switch.</li> <li>4. Disconnect the harness leads from the water inlet valve and measure the resistance of the valve coil.</li> <li>5. Instruct the customer on the drain stopper installation, refer to Use and Care Guide.</li> <li>6. Disconnect the water line to fill valve and inspect the inlet for obstructions.</li> <li>7. Check operation of the fill valve by the control during Diagnostics.</li> <li>8. Customer Instruct - normal water level is just above bottom of tub.</li> <li>9. Engage drain stopper. Run water into the dishwasher. If water drains out of the dishwasher, replace the stopper.</li> </ol>
<p>Wash pump will not pump.</p>	<ol style="list-style-type: none"> <li>1. Pump motor seized up (will not turn).</li> <li>2. Loose harness connection in pump motor circuit.</li> <li>3. Damaged wash pump motor capacitor.</li> <li>4. Pump motor winding opened.</li> <li>5. Faulty wash pump drive circuit on the control.</li> </ol>	<ol style="list-style-type: none"> <li>1. Remove the pump motor housing. Verify the rotation of the motor shaft by rotating the impeller. Rotation should only require a moderate force. If the rotation is difficult or not possible, replace the pump &amp; motor assembly.</li> <li>2. Check the resistances of all connections between the pump motor and the control, particularly the pump motor to its capacitor.</li> <li>3. Disconnect the capacitor leads and confirm that the capacitance is as labeled on part. Also check the resistance for an open circuit across the terminals. Replace if open.</li> <li>4. Disconnect all leads and check the resistance of the windings.</li> <li>5. Check the operation of the wash pump motor by the control during Diagnostics.</li> </ol>

<b>PROBLEM</b>	<b>POSSIBLE CAUSE</b>	<b>SOLUTION</b>
<p>Unit will not drain or there is excess water left in unit. The Check Drain LED is flashing.</p>	<ol style="list-style-type: none"> <li>1. Obstructed drain hose or drain path.</li> <li>2. Loose harness connection in drain motor circuit.</li> <li>3. Open winding on drain pump motor.</li> <li>4. Drain pump impeller fractured.</li> <li>5. Drain hose check valve not sealing.</li> <li>6. Faulty drain motor drive circuit on control.</li> </ol>	<ol style="list-style-type: none"> <li>1. Check for blockages from the drain pump to sump. Potential items: blocked/stuck drain pump or drain hose check valve, and/or plugged hoses.</li> <li>2. Check the resistances of all connections between the drain motor and control.</li> <li>3. Disconnect the harness connections and check the resistance of the drain motor windings.</li> <li>4. Remove the drain pump and check the impeller by pulling and rotating it. If the impeller pulls off easily, or turns freely (normally there is some uneven resistance), it is stripped. Replace the pump.</li> <li>5. Disconnect the drain hose at the air gap. Elevate the hose above the dishwasher and fill with water. If water flows into dishwasher, replace the drain hose.</li> <li>6. Check the operation of the drain motor by the control during Diagnostics.</li> </ol>
<p>Poor wash performance.</p>	<ol style="list-style-type: none"> <li>1. Customer cycle selection not appropriate for dish load.</li> <li>2. Plugged or damaged screens.</li> <li>3. Spray arms not rotating.</li> </ol>	<ol style="list-style-type: none"> <li>1. Instruct the customer on the cycle selection.</li> <li>2. Inspect following 3 screens. Remove the dish rack and inspect the fine filter screen. Remove the coarse filter and the drain screen basket. Clean or replace as needed.</li> <li>3. Check for free and proper arm rotation by operating the dishwasher and opening the lid to check that the location of the arms are not always in the same place. If the arms are blocked, instruct customer on stacking dishes. May also have restricted flow/movement due to misalignment or misassembly of the spray arm water delivery system.</li> </ol>
<p>Film on glasses and/or dishes.</p>	<ol style="list-style-type: none"> <li>1. Hard water leaving film on dishes.</li> <li>2. Detergent carryover.</li> <li>3. Drain hose check valve not sealing.</li> </ol>	<ol style="list-style-type: none"> <li>1. Check for water hardness. If hard, instruct the customer to use the maximum detergent, or try pouring 1/8 cup of Glass Magic into the bottom of dishwasher. To clean the dishwasher, recommend running with 1/2 cup of white vinegar sitting upright in the dish rack.</li> <li>2. Check water hardness. If below 10 grains, instruct customer to use less detergent.</li> <li>3. Disconnect the drain hose at the air gap. Elevate the hose above the dishwasher and fill with water. If water flows into dishwasher, replace the drain hose.</li> </ol>

PROBLEM	POSSIBLE CAUSE	SOLUTION
Poor drying performance.	<ol style="list-style-type: none"> <li>1. Customer use issues.</li> <li>2. Heater problem. Check for an open connection or component in the heater circuit, an open in the heater, or a faulty heater drive circuit on control.</li> <li>3. Rinse Aid dispenser not dispensing due to a loose harness connection.</li> <li>4. Open coil on the dispenser solenoid.</li> <li>5. Faulty dispenser drive circuit on control.</li> </ol>	<ol style="list-style-type: none"> <li>1. Recommend using Rinse Aid. Instruct on how to fill and monitor Rinse Aid.</li> <li>2. Check all components and connections in the water heating circuit. Check the resistances of all connections and components between heater and control. Check the resistance of heater, and its operation during the Diagnostics cycle.</li> <li>3. Check the resistance of all connections between the dispenser and the control.</li> <li>4. Disconnect the leads and check the resistance of the dispenser coil.</li> <li>5. Check the operation of the dispenser by the control during Diagnostics.</li> </ol>
Lid not opening after cycle.	<ol style="list-style-type: none"> <li>1. Faulty lid actuator.</li> <li>2. Foreign material in plunger housing.</li> <li>3. Customer use issues.</li> </ol>	<ol style="list-style-type: none"> <li>1. Check all components and connections in the lid actuator circuit. Check the resistances of all connections and components between the control and the lid actuator. Check the resistance of the actuator, and check to see that the lever from the actuator engages the slider in the latch assembly.</li> <li>2. Manually push plunger down and inspect the area for foreign matter. Remove or replace the housing as needed.</li> <li>3. Instruct customer not to leave items on the lid during the wash cycle.</li> </ol>
Lid not latching.	<ol style="list-style-type: none"> <li>1. Lid knob not oriented properly.</li> <li>2. Foreign material in plunger housing.</li> </ol>	<ol style="list-style-type: none"> <li>1. Check that the indicator on the knob aligns with the indicator on the lid. If misaligned, repair or replace the lid actuator assembly.</li> <li>2. Manually push the plunger down and inspect the area for foreign matter. Remove or replace the housing as needed.</li> </ol>

— NOTES —

# WIRING DIAGRAM & STRIP CIRCUITS

## SCHEMATIC DIAGRAM

SCHEMATIC SHOWN WITH DOOR SWITCH & ALL OTHER NORMALLY-OPEN CONTACTS OPEN.

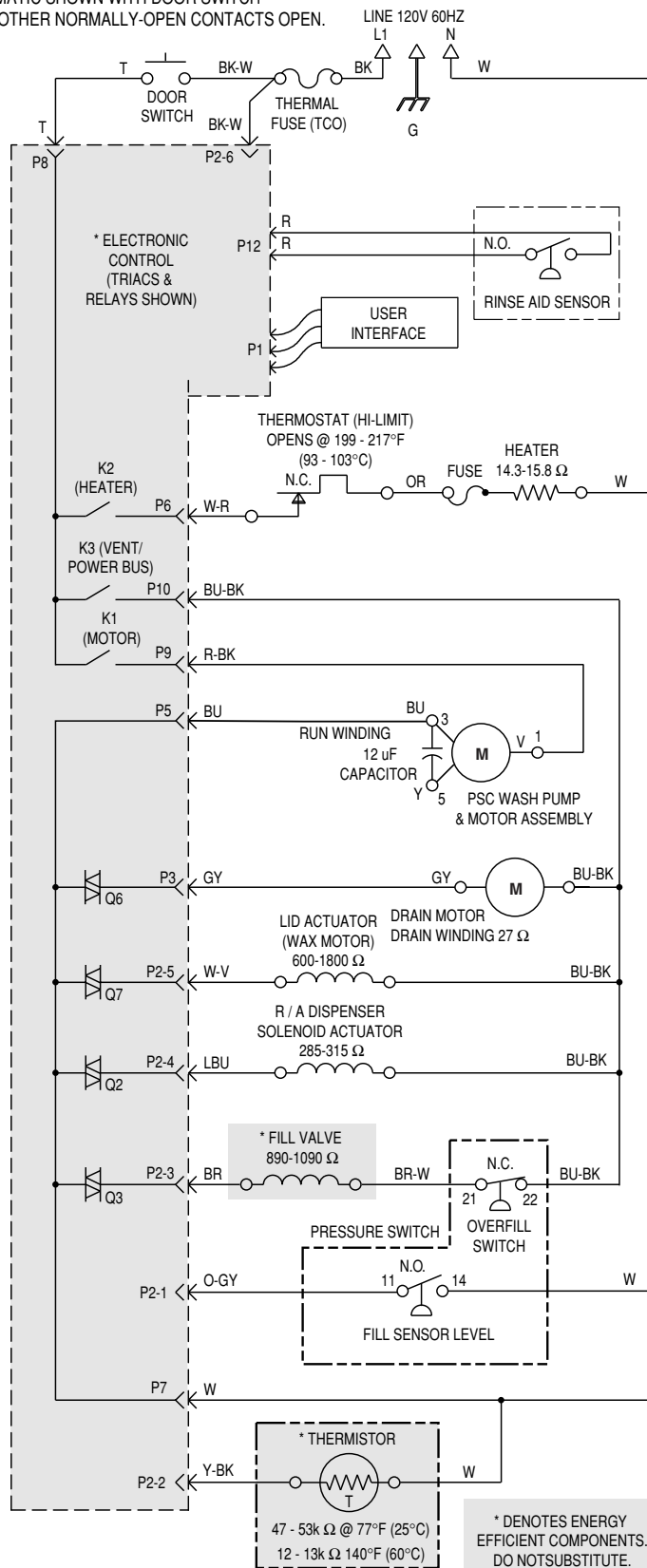

### CONNECTOR PINOUTS

- P8 AC HOT (LOADS) (T)
- P9 WASH MOTOR AC (R-BK)
- P10 VENT / SMALL LOAD AC (BU-BK)
- P7 AC NEUTRAL (W)

- P6 HEATER (W-R)
- P5 WASH MOTOR RETURN (BU)
- P4 OPEN
- P3 DRAIN MOTOR (GY)

- P2-1 PRESSURE (O-GY)
- P2-2 THERMISTOR / THERMOSTAT (Y-BK)
- P2-3 WATER FILL (BR)
- P2-4 DISPENSER (LBU)
- P2-5 LID ACTUATOR (W-V)
- P2-6 AC HOT (MICRO) (BK-W)

- P12-1 R/A (R)
- P12-2 OPEN
- P12-3 R/A (R)

- P1-1 } U/I RETURN LINE
- P1-2 } U/I RETURN LINE
- P1-3 } U/I RETURN LINE
- P1-4 } U/I RETURN LINE
- P1-5 } U/I RETURN LINE
- P1-6 } U/I RETURN LINE
- P1-7 } U/I RETURN LINE
- P1-8 } U/I LED LINE
- P1-9 } U/I LED LINE
- P1-10 } U/I LED LINE
- P1-11 } U/I KEY LINE
- P1-12 } U/I KEY LINE
- P1-13 } U/I KEY LINE
- P1-14 U/I LED LINE

\* DENOTES ENERGY EFFICIENT COMPONENTS. DO NOT SUBSTITUTE.

# STRIP CIRCUITS

## POWER UP

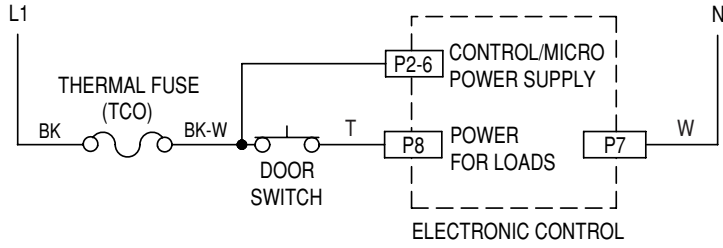

## FILL

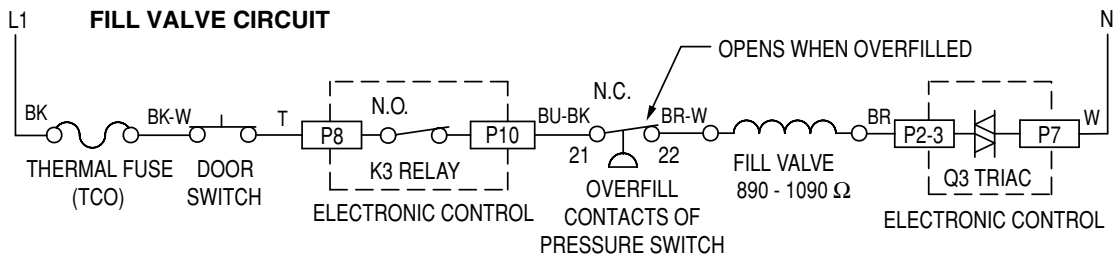

### WATER LEVEL SENSING CIRCUIT

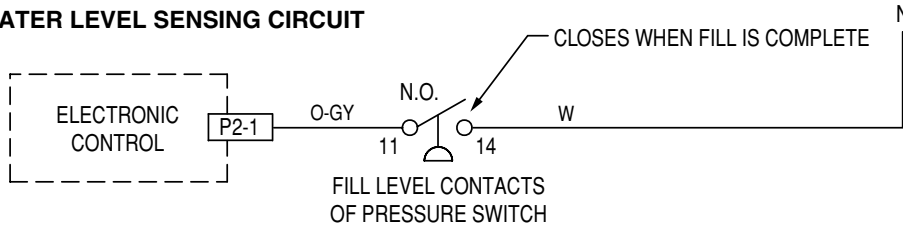

## WASH / RINSE

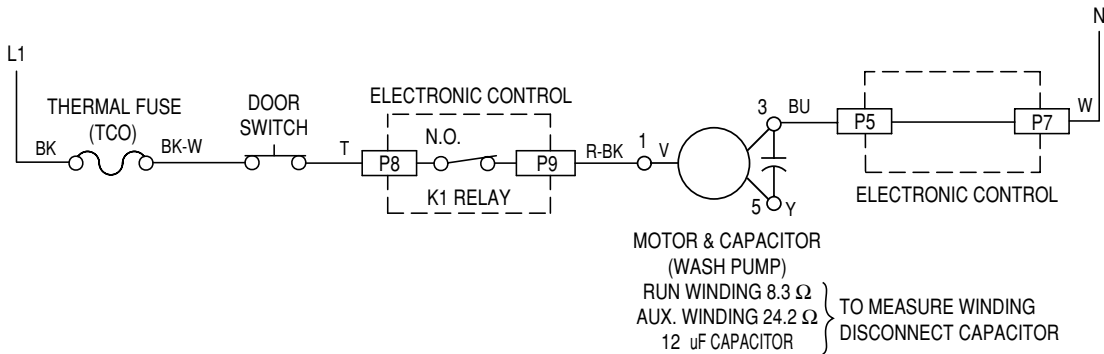



## DRAIN

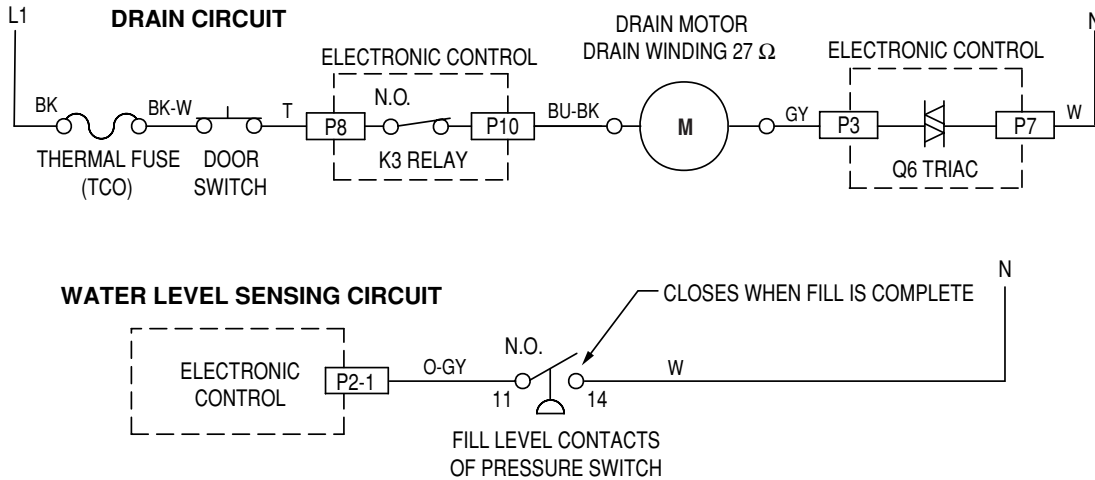

## WATER HEATING (PUMP IS ALSO WASHING DURING WATER HEATING PERIODS—SEE “WASH/RINSE”)

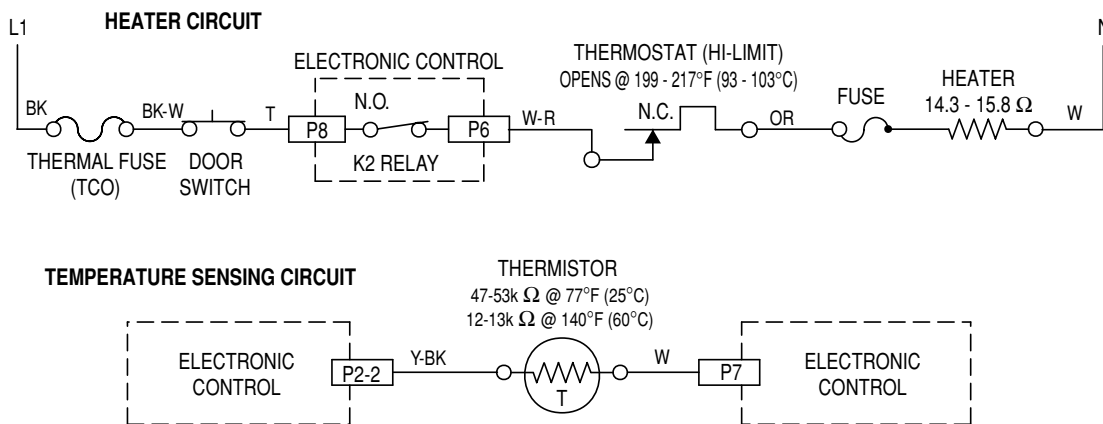

## LID ACTUATOR

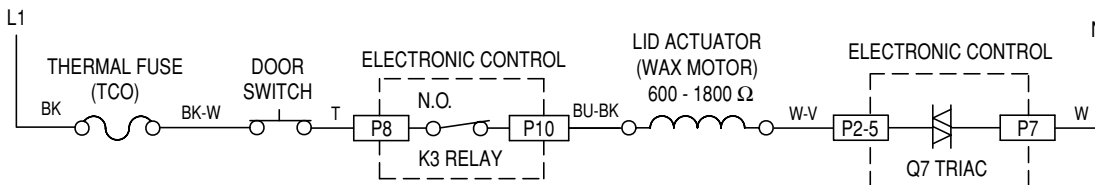

— NOTES —

# **PRODUCT SPECIFICATIONS AND WARRANTY INFORMATION SOURCES**

***IN THE UNITED STATES:***

**FOR PRODUCT SPECIFICATIONS AND WARRANTY INFORMATION CALL:**

FOR WHIRLPOOL PRODUCTS: 1-800-253-1301  
FOR KITCHENAID PRODUCTS: 1-800-422-1230  
FOR ROPER PRODUCTS: 1-800-447-6737

**FOR TECHNICAL ASSISTANCE WHILE AT THE CUSTOMER'S HOME CALL:**

THE TECHNICAL ASSISTANCE LINE: 1-800-253-2870

**HAVE YOUR STORE NUMBER READY TO IDENTIFY YOU AS AN  
AUTHORIZED SERVICER**

**FOR LITERATURE ORDERS:**

PHONE: 1-800-851-4605

**FOR TECHNICAL INFORMATION AND SERVICE POINTERS:**

[www.servicematters.com](http://www.servicematters.com)

---

***IN CANADA:***

**FOR PRODUCT SPECIFICATIONS AND WARRANTY INFORMATION CALL:**

1-800-461-5681

**FOR TECHNICAL ASSISTANCE WHILE AT THE CUSTOMER'S HOME CALL:**

THE TECHNICAL ASSISTANCE LINE: 1-800-488-4791

**HAVE YOUR STORE NUMBER READY TO IDENTIFY YOU AS AN  
AUTHORIZED SERVICER**

**KitchenAid**<sup>®</sup>  
FOR THE WAY IT'S MADE.<sup>®</sup>

