

KitchenAid

TECHNICAL EDUCATION

**BUILT-IN
MICROWAVE / OVEN
COMBINATION**



JOB AID 4317316

FORWARD

This Job Aid, "KitchenAid Built-In Microwave/Oven Combination," (Part No. 4317316), provides the technician with information on servicing the KitchenAid Built-In Microwave/Oven Combination. It is to be used as a training Job Aid and Service Manual. For specific information on the model being serviced, refer to the "Use and Care Guide," or "Tech Sheet" provided with the Microwave/Oven Combination.

The Wiring Diagrams and Strip Circuits used in this Job Aid are typical and should be used for training purposes only. Always use the Wiring Diagram supplied with the product when servicing the unit.

GOALS AND OBJECTIVES

The goal of this Job Aid is to provide detailed information that will enable the service technician to properly diagnose malfunctions and repair the Built-In Microwave/Oven Combination.

The objectives of this Job Aid are to:

- Understand and follow proper safety precautions.
- Successfully troubleshoot and diagnose malfunctions.
- Successfully perform necessary repairs.
- Successfully return the Microwave/Oven Combination to its proper operational status.

WHIRLPOOL CORPORATION assumes no responsibility for any repairs made on our products by anyone other than Authorized Service Technicians.

TABLE OF CONTENTS

	Page
GENERAL	1-1
Important Safety Information	1-1
Warning To Service Technicians	1-3
Precautions To Be Observed Before And During Servicing To Avoid Possible Exposure To Excessive Microwave Energy	1-4
R.F. Leakage Test	1-5
KitchenAid Model & Serial Number Designations	1-6
Model & Serial Number Label & Tech Sheet Locations	1-7
Specifications	1-8
KitchenAid Built-In Microwave Warranty	1-12
COMPONENT ACCESS	2-1
<i>Oven Cabinet Components</i>	2-1
Removing The Oven Control & Display Boards And The Touch Panel Assembly	2-2
Removing The Low Voltage Transformer, The Light Power Supplies, The Line Fuse & Fuseholder, & Suppressor Board	2-4
Removing The Upper Blower Motor Assembly	2-6
<i>Microwave Oven Components</i>	2-8
Removing The Microwave Oven Assembly	2-8
Removing The Primary & Secondary Interlock And Monitor Switches, And The Air Pressure Relief Valve	2-10
Removing The Grill Thermal Fuse And The Grill Element Assembly	2-12
Removing The Convection Temperature Sensor, The Halogen Lamp, And The Cavity Thermal Fuse	2-14
Removing The Convection Thermal Fuse, Convection Element, And Convection Fan Motor	2-16
Removing The Cooling Fan Motor & Air Vent Solenoid	2-18
Removing The Magnetron Thermal Fuse And The Magnetron	2-20
Removing The High Voltage Transformer	2-22
Removing The Line Fuse & Fuseholder, The High Voltage Rectifier, & High Voltage Capacitor	2-24
Removing The Turntable Motor	2-26
Removing The Oven Door Handle & Front Door Glass	2-27
Removing The Oven Door & The Inner Glass	2-28
<i>Lower Oven Components</i>	2-30
Removing The Lower Oven Door Latch Assembly	2-31
Removing The Broil Element	2-32
Removing The Oven Temperature Sensor	2-33

	Page
Removing A Halogen Lamp Assembly	2-34
Removing The Meat Probe Jack	2-35
Removing The Rear Panels	2-36
Removing The Convection Bake Element & Fan Motor Assembly	2-37
Removing The Lower Blower Motor Assembly	2-39
Removing The Oven Shutdown Thermal Fuse & Hidden Bake Element	2-40
Removing The Oven Door	2-42
Removing The Oven Door Glass, Hinges, & Handle	2-43
Removing The Oven Door Gasket	2-45
COMPONENT TESTING	3-1
The General Oven Components	3-1
Low Voltage Transformer	3-1
Main Line Fuse	3-2
Light Power Supplies	3-2
The Microwave Oven Components	3-3
Turntable Motor	3-3
Cooling Fan Motor	3-3
Upper Blower Motor	3-4
Convection Fan Motor	3-4
Convection Temperature Sensor	3-5
Cavity, Grill, Convection, & Magnetron Thermal Fuses	3-6
Convection Element	3-7
Grill Element Assembly	3-7
Line Fuse, High Voltage Rectifier, & High Voltage Capacitor	3-8
Air Vent Solenoid	3-9
Interlock Switches	3-9
High Voltage Transformer	3-10
Magnetron	3-10
The Lower Oven Components	3-11
Oven Door Latch Assembly	3-11
Lower Blower Motor	3-12
Oven Temperature Sensor	3-12
Convection Bake Element	3-13
Convection Fan Motor	3-13
Broil Element	3-14
Hidden Bake Element	3-14
Oven Shutdown Thermal Fuse	3-15
DIAGNOSIS & TROUBLESHOOTING	4-1
Failure/Error Display Codes	4-1
Microwave Oven Relay Logic	4-2
Lower Oven Relay Logic	4-2
Microwave Oven Power Output Test	4-2
WIRING DIAGRAMS & STRIP CIRCUITS	5-1

GENERAL

IMPORTANT SAFETY INFORMATION

Your safety and the safety of others is very important.

Important safety messages have been provided in this Job Aid. Always read and obey all safety messages.



This is the safety alert symbol. This symbol alerts you to hazards that can kill or hurt you and others.

All safety messages will be preceded by the safety alert symbol and the word **“WARNING.”**

All safety messages will identify the hazard, tell you how to reduce the chance of injury, and tell you what can happen if the instructions are not followed.

WARNING

ELECTRICAL SHOCK HAZARD

Disconnect power before servicing.
Replace all panels before operating.
Failure to do so could result in death or electrical shock.

IMPORTANT SAFETY INSTRUCTIONS

Before touching any oven component or wiring, always unplug the oven from its power source and discharge the capacitor by using a 20,000 ohm discharge resistor or use an insulated plastic handle screwdriver to short across the capacitor terminals.

Check that the unit is grounded before troubleshooting. Be careful of the high voltage circuits. Discharge any static charge from your body by touching ground before handling any part of the circuitry on the control board. Electrostatic discharge may damage the control circuit.

Do not touch oven components or wiring during operation. Attach meter leads with alligator clips when making operational tests.

For continued protection against radiation emission, replace only with these types of switches: Primary (Interlock) Switch: SZM-V16-FA-63 or VP-533A-OF; Secondary (Interlock) Switch: SZM-V01-FA-32; Interlock (Monitor) Switch: SZM-VI6-FA-62 or VP-532A-OF; Oven Lamp Switch: SZM-V6-FA-31 or VP-331 A-OD.

It is neither necessary nor advisable to attempt measurement of high voltage.

Attaching the adaptor ground terminal to the wall receptacle cover screw does not ground the appliance unless the cover screw is metal and not insulated and the wall receptacle is grounded through the house wiring.

ELECTROSTATIC DISCHARGE (ESD) SENSITIVE ELECTRONICS

ESD problems are present everywhere. ESD may damage or weaken the electronic control assembly. The new control assembly may appear to work well after repair is finished, but failure may occur at a later date due to ESD stress.

- Use an antistatic wrist strap. Connect the wrist strap to a green ground connection point or unpainted metal in the appliance; or touch your finger repeatedly to a green ground connection point or unpainted metal in the appliance.
- Before removing the part from its package, touch the antistatic bag to a green ground connection point or unpainted metal in the appliance.
- Avoid touching electronic parts or terminal contacts. Handle the electronic control assembly by the edges only.
- When repackaging the failed electronic control assembly in an antistatic bag, observe the above instructions.

WARNING

ELECTRICAL SHOCK HAZARD

Improper use of the grounding plug can result in a risk of electric shock.

GROUNDING INSTRUCTIONS

CORD CONNECTED

The microwave oven must be grounded. In the event of an electrical short circuit, grounding reduces the risk of electric shock by providing an escape wire for the electrical current. The microwave oven is equipped with a cord having a grounding wire with a grounding plug. The plug must be plugged into an outlet that is properly installed and grounded.

Consult a qualified electrician or serviceman if the grounding instructions are not completely understood, or if doubt exists as to whether the microwave oven is properly grounded. Do not use an extension cord. If the power supply cord is too short, have a qualified electrician or serviceman install an outlet near the microwave oven.

PERMANENTLY CONNECTED

The microwave oven must be connected to a grounded, metallic, permanent wiring system, or an equipment grounding conductor should be run with the circuit conductors and connected to the equipment grounding terminal, or lead, on the microwave oven.

WARNING TO SERVICE TECHNICIANS

To avoid possible exposure to microwave radiation or energy, visually check the oven for damage to the door and door seal before operating any oven. Use a microwave survey meter to check the amount of leakage before servicing. In the event the R.F. leakage exceeds 4 mw/cm² at 5 cm, appropriate repair must be made before continuing to service the unit. Check interlock function by operating the door latch. The oven cook cycle should cut off before the door can be opened.

The door and latching assembly contains the radio frequency energy within the oven. The door is protected by three safety interlock switches. Do not attempt to defeat them.

Under no circumstances should you try to operate the oven with the door open.

- Proper operation of microwave ovens requires that the magnetron be properly assembled to the waveguide and cavity. Never operate the magnetron unless it is properly installed.
- Be sure the "RF" seal is not damaged and is assembled around the magnetron dome properly when installing the magnetron.
- Routine service safety procedures should be exercised at all times.
- Untrained personnel should not attempt service without a thorough review of test procedures and safety information contained in this Job Aid.

KitchenAid microwave ovens have a monitoring system designed to assure proper operation of the safety interlock systems.

The interlock monitor switch will immediately cause the oven fuse to blow if the door is opened and the primary door interlock switch and/or the secondary interlock switch contacts fail in a closed position.

CAUTION: Replace a blown fuse with a 20 ampere class H fuse only.

Test the upper and lower door interlock switches, cook relay and interlock monitor switch (middle switch) for proper operation as described in the component test procedures, before replacing the blown oven fuse.

Do not attempt to repair sticking contacts of any interlock switch, safety switch, or Cook (Latch) relay. The components must be replaced.

Any indication of sticking contacts during component tests requires replacement of that component to assure reliability of the safety interlock system.

If the fuse is blown, the Monitor, Primary, and Secondary interlock switches must be replaced. Be sure they are properly connected.

PRECAUTIONS TO BE OBSERVED BEFORE AND DURING SERVICING TO AVOID POSSIBLE EXPOSURE TO EXCESSIVE MICROWAVE ENERGY

- A. Do not operate or allow the oven to be operated with the door open.
- B. Make the following safety checks on all ovens to be serviced before activating the magnetron or other microwave source, and make repairs as necessary:
 - 1) Interlock Operation
 - 2) Proper Door Closing
 - 3) Seal and Sealing Surfaces (Arcing, Wear, and Other Damage)
 - 4) Damage to or Loosening of Hinges and Latches
 - 5) Evidence of Dropping or Abuse
- C. Before turning on the microwave power for any service test or inspection within the microwave generating components, check the magnetron, wave guide or transmission line, and cavity for proper alignment, integrity, and connections.
- D. Any defective or misadjusted components in the interlock, monitor, door seal, and microwave generation and transmission systems shall be repaired, replaced, or adjusted, using procedures described in this Job Aid, before the oven is released to the owner.
- E. A microwave leakage check to verify compliance with Federal Performance Standard should be performed on each oven prior to release to the owner.
- F. Do not attempt to operate the oven if the door glass is broken.

R.F. LEAKAGE TEST

EQUIPMENT

- Electromagnetic energy leakage monitor (NARDA 8100B, HOLADAY H 1501).
- 275 ±15 ML glass beaker.

TEST

On every service call, checks for microwave energy emission must be made according to the following manner.

1. Remove the cooking rack from the oven cavity, if the microwave oven is so equipped.
2. Place a 275 ±15 ML (9.3 oz.) glass of water in the center of the oven bottom.
3. Select "HIGH" cook power, turn the microwave oven on, and test for R.F. leakage at the following locations:
 - a) Around the cabinet at the front.
 - b) Around the door.
 - c) Across the console panel.
 - d) Horizontally across the door.
 - e) Vertically across the door.
 - f) Diagonally across the door.
 - g) Across the air vents.
 - h) Across the rear air vent.
 - i) All lockseams.
 - j) Weld at bottom.
 - k) Bottom plate.
 - l) Oven feet.
4. The scan speed is one inch per second.

When checking for R.F. leakage, use an approved R.F. measuring device to assure less than 4 mw/cm² emission at 5 cm distance with a maximum scan rate of 2.54 cm/second, in compliance with U.S. Government Department of Health, Education and Welfare 21CFR1030, Performance Standard for Microwave Ovens.

A properly operating door and seal assembly will normally register small emissions, but they must be no greater than 4 mw/cm² to allow for measurement uncertainty.

NOTE: Enter leakage readings in space BEFORE and AFTER on the service document.

All microwave ovens exceeding the emission level of 4 mw/cm² must be reported to Dept. of Service for Microwave Ovens immediately and the owner should be told not to use the microwave oven until it has been repaired completely.

If a microwave oven is found to operate with the door open, report to Dept. of Service, the manufacturer and CDRH* immediately. Also tell the owner not to use the oven.

The interlock monitor switch acts as the final safety switch protecting the customer from microwave radiation. If the interlock monitor switch operated to blow the fuse when the interlocks failed, you must replace all interlock switches with new ones, because the contacts of those interlock switches may be melted and welded together.

If safety interlock/monitor switch replacement, or adjustment, is required, you must reconnect the circuit, and perform a continuity check on the monitor circuit.

All repairs must be performed in such a manner that microwave energy emissions are minimal.

Address for CDRH is:

**Office of Compliance (HFZ-342) Center for
Devices and Radiological Health
2098 Gaither Road
Rockville, MD 20850**

* CDRH: Center for Devices and Radiological Health, Food and Drug Administration.

KITCHENAID MODEL & SERIAL NUMBER DESIGNATIONS

MODEL NUMBER

MODEL NUMBER		K	EH	C	3	0	9	J	SS	0
INTERNATIONAL SALES IND. OR MARKETING CHANNEL IF PRESENT										
PRODUCT GROUP K = KITCHENAID BRAND										
PRODUCT IDENTIFICATION EB = ELECTRIC BUILT-IN OVEN EH = ELECTRIC BUILT-IN HI SPEED COMBO EM = ELECTRIC BUILT-IN MICRO COMBO EW = ELECTRIC WARMING OVEN GB = GAS BUILT-IN OVEN GM = GAS BUILT-IN MICRO COMBO OVEN										
MERCHANDISING SCHEME C = FLUSH LOOK D = DRAWER I = IMPERIAL N = INTERNATIONAL COLLECTION EUROPEAN S = SUPERBA										
CAPACITY / SIZE / SERIES / CONFIGURATION 1ST POSITION 2ND POSITION 1 = SINGLE OVEN 4 = 24" WIDE 2 = DOUBLE OVEN 6 = 36" WIDE 3 = COMBO OVEN 7 = 27" WIDE 4 = OVEN W/DRAWER 0 = 30" WIDE 5 = MINI OVEN 6 = COMBO W/MINI OVEN										
FEATURES 0 = STANDARD FEATURES 1 = STANDARD FEATURES / ELECTRIC CLOCK 5 = DELUXE FEATURES 6 = DELUXE FEATURES / ELECTRIC CLOCK 7 = DELUXE FEATURES / THERMAL CONVECTION 8 = DOUBLE THERMAL CONVECTION 9 = MULTI-MODE										
YEAR OF INTRODUCTION D = 1995, G = 1998, H = 1999, J = 2000										
COLOR CODE AL = ALMOND, BL = BLACK, BS = BLACK ON STAINLESS, BT = BISCUIT, SS = BRUSHED STAINLESS STEEL, WH = WHITE										
ENGINEERING CHANGE (0, 1, 2, ETC.)										

SERIAL NUMBER

SERIAL NUMBER	X	K	16	01004
MANUFACTURING SITE X = OXFORD				
YEAR OF PRODUCTION K = 2000, L = 2001, M = 2002				
WEEK OF PRODUCTION 16TH WEEK				
PRODUCT SEQUENCE NUMBER				

SPECIFICATIONS

Model Number	KEMS377D	KEMS307D	KEMS378G	KEMS308G
Colors Available	BS,	BS	SS	SS
Model Description	MW/BI Combo	MW/BI Combo	MW/BI Combo	MW/BI Combo
Size-Configuration	27"	30"	27"	30"
Dimensions/Specifications				
Overall Height (in)	42 3/8"	42 3/8"	42 3/8"	42 3/8"
Overall Width (in)	26 3/4"	29 3/4"	26 3/4"	29 3/4"
Overall Depth Inc Hrdwr/Hndl (in)	25 1/8"	25 1/8"	25 1/8"	25 1/8"
Depth W/O Handle (in)	23 7/8"	23 7/8"	23 7/8"	23 7/8"
Cutout Dimensions				
Cutout Height (in) (Measure Or Min/Max)	41 1/4"	41 1/4"	41 1/4"	41 1/4"
Cutout Width (in) (Measure Or Min/Max)	25 1/2"	28 1/2"	25 1/2"	28 1/2"
Cutout Depth (in) (Measure Or Min/Max)	23 1/4"	23 1/4"	23 1/4"	23 1/4"
Other Dimensions				
Conduit Size (in) (Length/Diameter)	57"; 1/2"	57"; 1/2"	57"; 1/2"	57"; 1/2"
Net Weight (lbs)	210	216	210	216
Shipping Weight (lbs)	221	227	221	227
Total Connected Load in kW				
240 Volts	8.5 kw	8.5 kw	E	8.5 kw
208 Volts	7.4 kw	7.4 kw	E	7.4 kw
Circuit Amps	40 AMP	40 AMP	40 AMP	40 AMP
Exterior				
Oven Front Frame	Porcelain	Porcelain	Porcelain	Porcelain
Oven Control Type	Electronic	Electronic	Electronic	Electronic
Membrane Touch	Yes	Yes	Yes	Yes
Microwave Timer	Yes	Yes	Yes	Yes
Child Lock Out	Yes	Yes	Yes	Yes
Temperature Probe	Yes	Yes	Yes	Yes
Microwave Oven Features				
Diagnostics	Yes	Yes	Yes	Yes
Error Indication	Yes	Yes	Yes	Yes
MW Power (Watts)	900 Watts	900 Watts	900 Watts	900 Watts
Stoppable Turntable	No	No	No	No
Broil Element Output (Watts)	1200 Watts	1200 Watts	1200 Watts	1200 Watts
Broil Heat-Up Time	<1 minute	<1 minute	<1 minute	<1 minute
Interior				
MW Cavity Volume (cu ft)	1.4	1.4	1.4	1.4
MW Cavity Material	Stainless	Stainless	Stainless	Stainless
Main Oven				
Cooking System	True Convection	True Convection	True Convection	True Convection
Cleaning System	Self Cleaning	Self Cleaning	Self Cleaning	Self Cleaning
Auto Self Clean Latch	Yes	Yes	Yes	Yes
Main Oven Liner Finish	Porcelain	Porcelain	Porcelain	Porcelain
Main Oven Volume (cu ft)	3.73	4.24	3.73	4.24
Main Oven Height (in)	16"	16"	16"	16"
Main Oven Width (in)	22"	25"	22"	25"
Main Oven Depth (in)	18 1/2"	18 1/2"	18 1/2"	18 1/2"
Oven Light #/Location	2 Side Halogen	2 Side Halogen	2 Side Halogen	2 Side Halogen
Main Electric Oven				
Main Hidden Bake Element	Yes	Yes	Yes	Yes
Main Electric Element Output				
Main Oven Bake (w@240/208v)	2000W/1500W	2000W/1500W	2000W/1500W	2000W/1500W
Main Oven Broil Inner Element (w@240/208v)	1667W/1250W	1667W/1250W	1667W/1250W	1667W/1250W
Main Oven Broil Outer Element (w@240/208)	1000W/750W	1000W/750W	1000W/750W	1000W/750W
Main Oven Convection (w@240/208v)	1600W/1200W	1600W/1200W	1600W/1200W	1600W/1200W
Installation Instructions Part/Comment	4450412	4450412	4450412	4450412
Service Manual Part/Comment	4317316	4317316	4317316	4317316
Tech Sheet Part/Comment	4449034	4449034	4449034	4449034
Other				
Agency Approvals	UL	UL	UL	UL
Warranty				
Full (Months)	12	12	12	12
Extended				
Electronic Controls (Months)	60	60	60	60
Electrical Elements (Months)	60	60	60	60
Porcelain Liner/Door (Months)	120	120	120	120

Model Number	KEMC378H	KEMC308H	KEMS378G	KEMS377G
Colors Available	BL,WH, BT,	BL, BT, WH	BL, WH	AL, BL, BS, BT, WH
Model Description	MW/BI Combo	MW/BI Combo	MW/BI Combo	MW/BI Combo
Size-Configuration	27"	30"	27"	27"
Dimensions/Specifications				
Overall Height (in)	42 3/8"	42 3/8"	42 3/8"	42 3/8"
Overall Width (in)	26 3/4"	29 3/4"	26 3/4"	26 3/4"
Overall Depth Inc Hrdwr/Hndl (in)	25 1/8"	25 1/8"	25 1/8"	25 1/8"
Depth W/O Handle (in)	23 7/8"	23 7/8"	23 7/8"	23 7/8"
Cutout Dimensions				
Cutout Height (in) (Measure Or Min/Max)	41 1/4"	41 1/4"	41 1/4"	41 1/4"
Cutout Width (in) (Measure Or Min/Max)	25 1/2"	28 1/2"	25 1/2"	25 1/2"
Cutout Depth (in) (Measure Or Min/Max)	23 1/4"	23 1/4"	23 1/4"	23 1/4"
Other Dimensions				
Conduit Size (in) (Length/Diameter)	57"; 1/2"	57"; 1/2"	57"; 1/2"	57"; 1/2"
Net Weight (lbs)	210	216	210	210
Shipping Weight (lbs)	221	227	221	221
Total Connected Load in kW				
240 Volts	8.5 kw	8.5 kw	E	E
208 Volts	7.4 kw	7.4 kw	E	E
Circuit Amps	40 AMP	40 AMP	40 AMP	40 AMP
Exterior				
Oven Front Frame	Porcelain	Porcelain	Porcelain	Porcelain
Oven Control Type	Electronic	Electronic	Electronic	Electronic
Membrane Touch	Yes	Yes	Yes	Yes
Microwave Timer	Yes	Yes	Yes	Yes
Child Lock Out	Yes	Yes	Yes	Yes
Temperature Probe	Yes	Yes	Yes	Yes
Microwave Oven Features				
Diagnostics	Yes	Yes	Yes	Yes
Error Indication	Yes	Yes	Yes	Yes
MW Power (Watts)	900 Watts	900 Watts	900 Watts	900 Watts
Stoppable Turntable	No	No	No	No
Broil Element Output (Watts)	1200 Watts	1200 Watts	1200 Watts	1200 Watts
Broil Heat-Up Time	<1 minute	<1 minute	<1 minute	<1 minute
Interior				
MW Cavity Volume (cu ft)	1.4	1.4	1.4	1.4
MW Cavity Material	Stainless	Stainless	Stainless	Stainless
Main Oven				
Cooking System	True Convection	True Convection	True Convection	True Convection
Cleaning System	Self Cleaning	Self Cleaning	Self Cleaning	Self Cleaning
Auto Self Clean Latch	Yes	Yes	Yes	Yes
Main Oven Liner Finish	Porcelain	Porcelain	Porcelain	Porcelain
Main Oven Volume (cu ft)	3.73	4.24	3.73	3.73
Main Oven Height (in)	16"	16"	16"	16"
Main Oven Width (in)	22"	25"	22"	22"
Main Oven Depth (in)	18 1/2"	18 1/2"	18 1/2"	18 1/2"
Oven Light #/Location	2 Side Halogen	2 Side Halogen	2 Side Halogen	2 Side Halogen
Main Electric Oven				
Main Hidden Bake Element	Yes	Yes	Yes	Yes
Main Electric Element Output				
Main Oven Bake (w@240/208v)	2000W/1500W	2000W/1500W	2000W/1500W	2000W/1500W
Main Oven Broil Inner Element (w@240/208v)	1667W/1250W	1667W/1250W	1667W/1250W	1667W/1250W
Main Oven Broil Outer Element (w@240/208v)	1000W/750W	1000W/750W	1000W/750W	1000W/750W
Main Oven Convection jw@240/208v)	1600W/1200W	1600W/1200W	1600W/1200W	1600W/1200W
Installation Instructions Part/Comment	4450412	4450412	4450412	4450412
Service Manual Part/Comment	4317316	4317316	4317316	4317316
Tech Sheet Part/Comment	4449034	4449034	4449034	4449034
Other				
Agency Approvals	UL	UL	UL	UL
Warranty				
Full (Months)	12	12	12	12
Extended				
Electronic Controls (Months)	60	60	60	60
Electrical Elements (Months)	60	60	60	60
Porcelain Liner/Door (Months)	120	120	120	120

Model Number	KEMI371G	KEMI301G	KEMS307G
Colors Available	BL, WH	BL, WH	AL, BL, BS, BT, WH
Model Description	MW/BI Combo	MW/BI Combo	MW/BI Combo
Size-Configuration	27"	30"	30"
Dimensions/Specifications			
Overall Height (in)	42 3/8"	42 3/8"	42 3/8"
Overall Width (in)	26 3/4"	29 3/4"	29 3/4"
Overall Depth Inc Hrdwr/Hndl (in)	25 1/8"	25 1/8"	25 1/8"
Depth W/O Handle (in)	23 7/8"	23 7/8"	23 7/8"
Cutout Dimensions			
Cutout Height (in) (Measure Or Min/Max)	41 1/4"	41 1/4"	41 1/4"
Cutout Width (in) (Measure Or Min/Max)	25 1/2"	28 1/2"	28 1/2"
Cutout Depth (in) (Measure Or Min/Max)	23 1/4"	23 1/4"	23 1/4"
Other Dimensions			
Conduit Size (in) (Length/Diameter)	57"; 1/2"	57"; 1/2"	57"; 1/2"
Net Weight (lbs)	210	210	210
Shipping Weight (lbs)	221	221	221
Total Connected Load in kW			
240 Volts	E	E	E
208 Volts	E	E	E
Circuit Amps	40 AMP	40 AMP	40 AMP
Exterior			
Oven Front Frame	Porcelain	Porcelain	Porcelain
Oven Control Type	Electronic	Electronic	Electronic
Membrane Touch	Yes	Yes	Yes
Microwave Timer	Yes	Yes	Yes
Child Lock Out	Yes	Yes	Yes
Temperature Probe			
Microwave Oven Features			
Diagnostics	Yes	Yes	Yes
Error Indication	Yes	Yes	Yes
MW Power (Watts)	900 Watts	900 Watts	900 Watts
Stoppable Turntable	No	No	No
Broil Element Output (Watts)			
Broil Heat-Up Time			<1 Minute
Interior			
MW Cavity Volume (cu ft)	1.4	1.4	1.4
MW Cavity Material	Stainless	Stainless	Stainless
Main Oven			
Cooking System			
Cleaning System	Self Cleaning	Self Cleaning	Self Cleaning
Auto Self Clean Latch	Yes	Yes	Yes
Main Oven Liner Finish	Porcelain	Porcelain	Porcelain
Main Oven Volume (cu ft)	3.73	4.24	4.24
Main Oven Height (in)	16"	16"	16"
Main Oven Width (in)	22"	25"	25"
Main Oven Depth (in)	18 1/2"	18 1/2"	18 1/2"
Oven Light #/Location	2 Side Halogen	2 Side Halogen	2 Side Halogen
Main Electric Oven			
Main Hidden Bake Element	Yes	Yes	Yes
Main Electric Element Output			
Main Oven Bake (w@240/208v)	2000W/1500W	2000W/1500W	2000W/1500W
Main Oven Broil Inner Element (w@240/208v)	1667W/1250W	1667W/1250W	1667W/1250W
Main Oven Broil Outer Element (w@240/208)	1000W/750W	1000W/750W	1000W/750W
Main Oven Convection)w@240/208v)			1600W/1250W
Installation Instructions Part/Comment	4450412	4450412	4450412
Service Manual Part/Comment	4317316	4317316	4317316
Tech Sheet Part/Comment	4449034	4449034	4449034
Other			
Agency Approvals	UL	UL	UL
Warranty			
Full (Months)	12	12	12
Extended			
Electronic Controls (Months)	60	60	60
Electrical Elements (Months)	60	60	60
Porcelain Liner/Door (Months)	120	120	120

Model Number	KEMS308G	KEHC379J	KEHC309J
Colors Available	BL, WH	BL, BT, SS, WH	BL, BT, SS, WH
Model Description	MW/BI Combo	MW/BI Combo	MW/BI Combo
Size-Configuration	30"	27"	30"
Dimensions/Specifications			
Overall Height (in)	42 3/8"	42 3/8"	42 3/8"
Overall Width (in)	29 3/4"	26 3/4"	29 3/4"
Overall Depth Inc Hrdwr/Hndl (in)	25 1/8"	25 1/8"	25 1/8"
Depth W/O Handle (in)	23 7/8"	23 7/8"	23 7/8"
Cutout Dimensions			
Cutout Height (in) (Measure Or Min/Max)	41 1/4"	41 1/4"	41 1/4"
Cutout Width (in) (Measure Or Min/Max)	28 1/2"	25 1/2"	28 1/2"
Cutout Depth (in) (Measure Or Min/Max)	23 1/4"	23 1/4"	23 1/4"
Other Dimensions			
Conduit Size (in) (Length/Diameter)	57"; 1/2"	57"; 1/2"	57"; 1/2"
Net Weight (lbs)	210	210	216
Shipping Weight (lbs)	221	221	227
Total Connected Load in kW			
240 Volts	E	9.1 kw	9.1 kw
208 Volts	E	7.9 kw	7.9 kw
Circuit Amps	40 AMP	50 AMP	50 AMP
Exterior			
Oven Front Frame	Porcelain	Porcelain	Porcelain
Oven Control Type	Electronic	Electronic	Electronic
Membrane Touch	Yes	Yes	Yes
Microwave Timer	Yes	Yes	Yes
Child Lock Out	Yes	Yes	Yes
Temperature Probe		Yes	Yes
Microwave Oven Features			
Diagnostics	Yes	Yes	Yes
Error Indication	Yes	Yes	Yes
MW Power (Watts)	900 Watts	900 Watts	900 Watts
Stoppable Turntable	No	No	No
Broil Element Output (Watts)		1200 Watts	1200 Watts
Broil Heat-Up Time	<1 Minute	<1 minute	<1 minute
Interior			
MW Cavity Volume (cu ft)	1.4	1.4	1.4
MW Cavity Material	Stainless	Porcelain coated Stainless	Porcelain coated Stainless
Main Oven			
Cooking System	True Convection	True Convection	True Convection
Cleaning System	Self Cleaning	Self Cleaning	Self Cleaning
Auto Self Clean Latch	Yes	Yes	Yes
Main Oven Liner Finish	Porcelain	Porcelain	Porcelain
Main Oven Volume (cu ft)	4.24	3.73	4.24
Main Oven Height (in)	16"	16"	16"
Main Oven Width (in)	25"	22"	25"
Main Oven Depth (in)	18 1/2"	18 1/2"	18 1/2"
Oven Light #/Location	2 Side Halogen	2 Side Halogen	2 Side Halogen
Main Electric Oven			
Main Hidden Bake Element	Yes	Yes	Yes
Main Electric Element Output			
Main Oven Bake (w@240/208v)	2000W/1500W	2000W/1500W	2000W/1500W
Main Oven Broil Inner Element (w@240/208v)	1667W/1250W	1667W/1250W	1667W/1250W
Main Oven Broil Outer Element (w@240/208)	1000W/750W	1000W/750W	1000W/750W
Main Oven Convection (w@240/208v)	1600W/1250W	1600W/1200W	1600W/1200W
Installation Instructions Part/Comment	4450412	4450412	4450412
Service Manual Part/Comment	4317316	4317316	4317316
Tech Sheet Part/Comment	4449034	4449034	4449034
Other		High Speed Cook Label- 4452955/Safety Tips Brochure- 3191638	High Speed Cook Label- 4452955/Safety Tips Brochure-3191638
Agency Approvals	UL	UL	UL
Warranty			
Full (Months)	12	12	12
Extended			
Electronic Controls (Months)	60	60	60
Electrical Elements (Months)	60	60	60
Porcelain Liner/Door (Months)	120	120	120

KITCHENAID BUILT-IN MICROWAVE WARRANTY

LENGTH OF WARRANTY:	KITCHENAID WILL PAY FOR:	KITCHENAID WILL NOT PAY FOR:
<p>ONE-YEAR FULL WARRANTY From Date of Purchase.</p>	<p>Replacement parts and repair labor costs to correct defects in materials or workmanship. Service must be provided by a KitchenAid designated servicing company.</p>	<p>A. Service calls to:</p> <ol style="list-style-type: none"> 1. Correct the installation of the microwave oven. 2. Instruct you how to use the microwave oven. 3. Replace house fuses or correct house wiring. <p>B. Repairs when oven is used in other than normal single-family household use.</p>
<p>SECOND-THROUGH FIFTH-YEAR LIMITED WARRANTY From Date of Purchase.</p>	<p>Replacement parts for microwave magnetron or any oven electric element to correct defects in materials or workmanship. Replacement parts for solid state touch control system to correct defects in materials or workmanship.</p>	<p>C. Damage resulting from accident, alteration, misuse, abuse, fire, flood, acts of God, improper installation, installation not in accordance with local electrical codes, or use of products not approved by KitchenAid.</p> <p>D. Any labor costs during the limited warranties.</p> <p>E. Replacement parts or repair labor costs for units operated outside the United States or Canada.</p> <p>F. Pickup and delivery. This product is designed to be repaired in the home.</p> <p>G. Repairs to parts or systems resulting from unauthorized modifications made to the appliance.</p>
<p>SECOND-THROUGH TENTH-YEAR LIMITED WARRANTY From Date of Purchase.</p>	<p>Replacement parts for the stainless steel oven cavity/ inner door if the part rusts through due to defects in materials or workmanship.</p>	<p>H. In Canada, travel or transportation expenses for customers who reside in remote areas.</p>

KITCHENAID AND KITCHENAID CANADA DO NOT ASSUME ANY RESPONSIBILITY FOR INCIDENTAL OR CONSEQUENTIAL DAMAGES. Some states or provinces do not allow the exclusion or limitation of incidental or consequential damages, so this exclusion or limitation may not apply to you. This warranty gives specific legal rights and you may also have other rights which vary from state to state or province to province.

Outside the United States and Canada, a different warranty may apply. For details, please contact your authorized KitchenAid dealer.

If you need assistance or service, first see the "Diagnosis & Troubleshooting" section of this book. After checking "Diagnosis & Troubleshooting," additional help can be found by checking the "Requesting Assistance or Service" section in the Use And Care Guide. In the U.S.A., call our Consumer Assistance Center at: **1-800-422-1230**. In Canada, call KitchenAid Canada at: **1-800-461-5681** or **1-800-807-6777**.

COMPONENT ACCESS

This section instructs you on how to service each component inside the Built-In Microwave/ Oven Combination. The Component Access is divided into three sections:

- Oven Cabinet Components (page 2-1)
- Microwave Oven Components (page 2-8)
- Lower Oven Components (page 2-30)

Refer to the appropriate section for the component you are servicing.

OVEN CABINET COMPONENTS

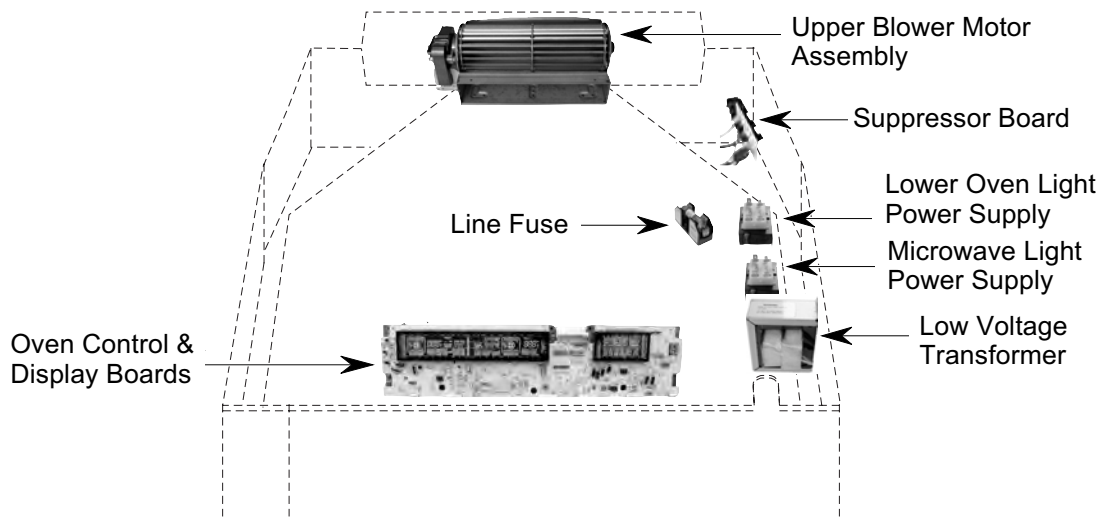

REMOVING THE OVEN CONTROL & DISPLAY BOARDS AND THE TOUCH PANEL ASSEMBLY

! WARNING

ELECTRICAL SHOCK HAZARD

Disconnect power before servicing.
 Replace all panels before operating.
 Failure to do so could result in death or electrical shock.

CAUTION: When you work on the microwave/oven combination, be careful when handling the sheet metal parts. Sharp edges may be present, and you can cut yourself if you are not careful.

1. Disconnect the electrical power to the microwave/oven combination.
2. Open the lower oven door.
3. Remove the bottom screw from each of the two side trim pieces (see below).
4. To remove the side trim, pull the bottom out approximately 2", and slide the top down to free it from the control panel.



Side Trim Screw
(1 On Each Side)



Pull Out Bottom
Of Side Trim

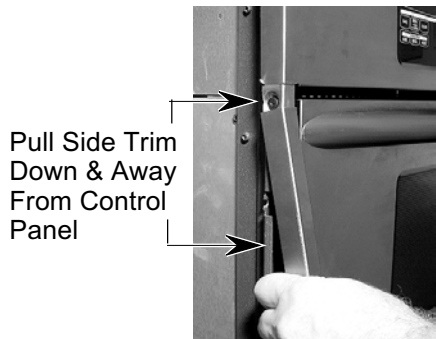

Pull Side Trim
Down & Away
From Control
Panel

5. Remove the screws from the oven control panel.



Control
Panel
Screw

6. To remove the oven control panel, pull it out at the bottom, and lift and unhook it from the oven cabinet support at the top.

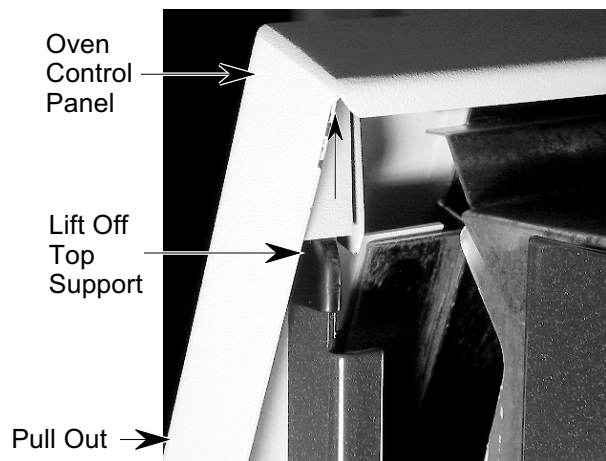

Oven
Control
Panel

Lift Off
Top
Support

Pull Out

7. Pull the ground clip on the end of the green wire from the edge of the metal panel, and disconnect the wire connectors from the board. Set the panel face down on a padded surface to protect the finish.

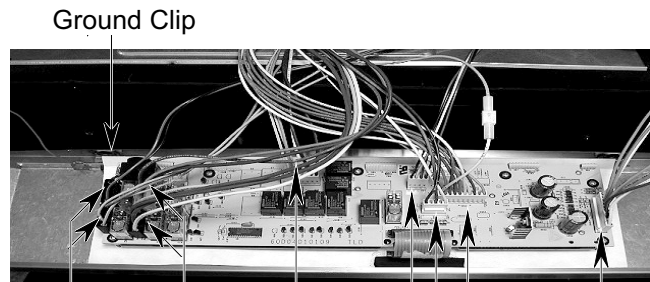

Ground Clip

Wire Connectors

8. **To remove the oven control & display boards:**

- a) Remove the seven mounting screws.
- b) Lift the ends of the locking arm and disconnect the ribbon cable from its connector.

NOTE: The control and display boards are designed to be replaced as an assembly.

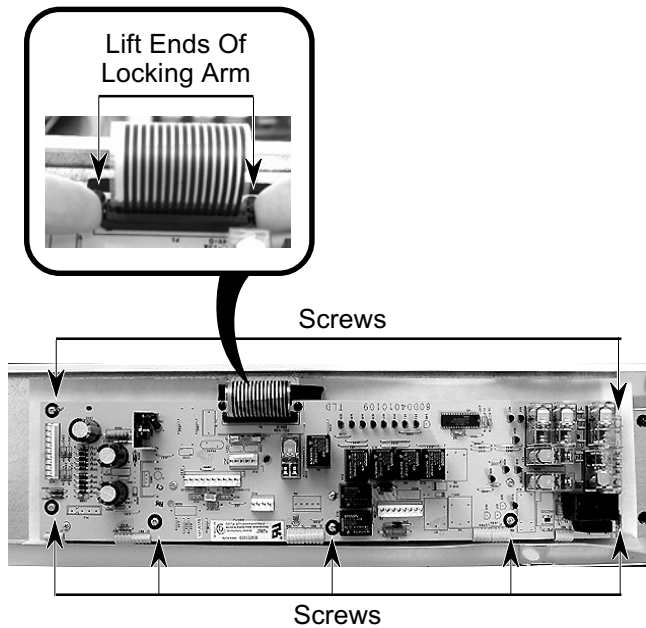

REASSEMBLY NOTE: When you reinstall the oven control panel, use the following procedure (refer to the photos on the previous page, as necessary):

1. Reconnect the wiring to the control board terminals.
2. Clip the ground wire to the metal edge of the control panel.
3. Hook the ends of the control panel over the rubber tips of the brackets.
4. Push the bottom of the control panel in and position the plastic air duct under the lip of the panel.



5. Align the mounting holes and install the two side screws in the control panel.

IMPORTANT NOTE: A “cavity size” connector (see the photo below) is provided on connector P5. The connector is on the end of the yellow wire coming from pin 10. This cavity size connector determines the various cycling of the cooking relays in the 27” and 30” ovens. Be sure to observe the proper cavity size configuration for the oven you are servicing.

- 30” ovens = Yellow to tan wires
- 27” ovens = Yellow not connected

9. **To remove the touch panel assembly:**

- a) Remove the standoffs and spacers from over the mounting studs.

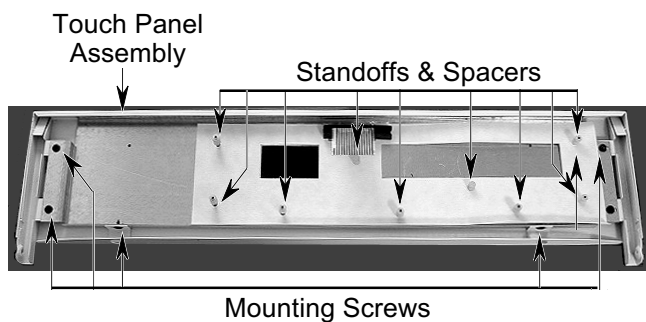

- b) Remove the six mounting screws.
- c) Lift the touch panel assembly off the front of the oven cabinet.

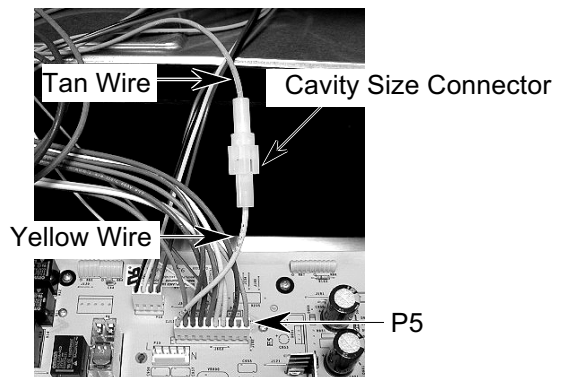

REMOVING THE LOW VOLTAGE TRANSFORMER, THE LIGHT POWER SUPPLIES, THE LINE FUSE & FUSEHOLDER, & SUPPRESSOR BOARD

! WARNING

ELECTRICAL SHOCK HAZARD

Disconnect power before servicing.
Replace all panels before operating.
Failure to do so could result in death or electrical shock.

CAUTION: When you work on the microwave/oven combination, be careful when handling the sheet metal parts. Sharp edges may be present, and you can cut yourself if you are not careful.

1. Disconnect the electrical power to the microwave/oven combination.
2. Remove the control panel (see page 2-2 steps 1 through 7 for the procedure) and position it out of the way.

The components described on these pages are shown below (shown with the top covers removed).

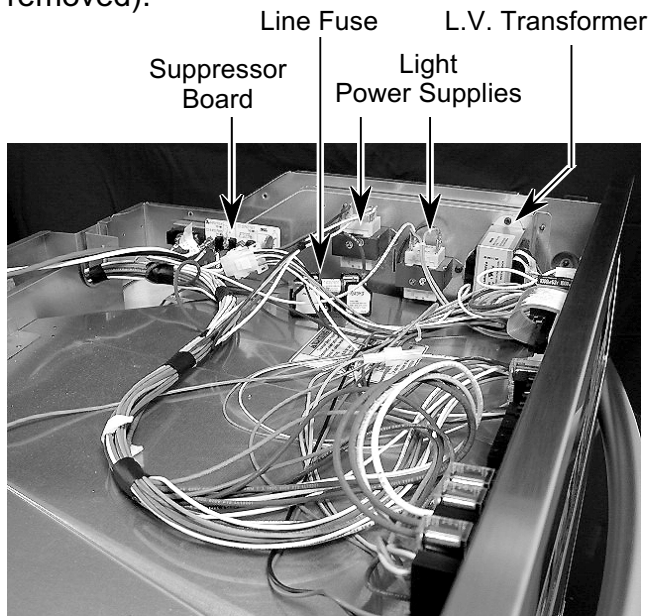

3. To remove the low voltage transformer:
 - a) Disconnect the 10-hole connector from the control board at P17.
 - b) Remove the mounting screw at the top and unhook the bottom transformer tab from the oven cabinet slot.

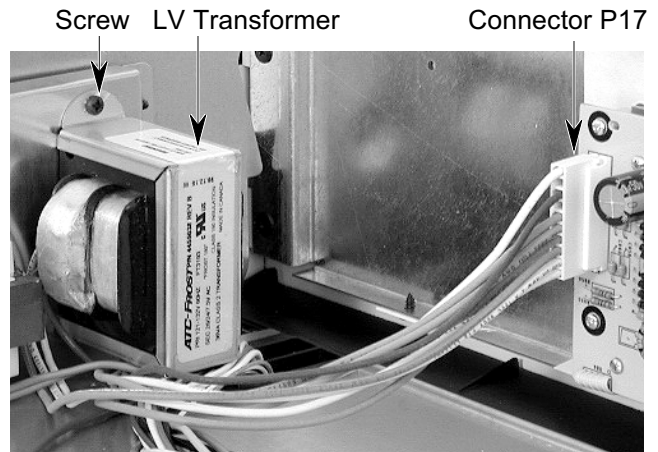

4. To remove a light power supply:
 - a) Disconnect the four wires from the LINE and LOAD terminals. Note that the LINE terminals are smaller than the LOAD terminals to prevent miswiring.
 - b) Remove the mounting screw and unhook the tab from the oven cabinet slot.

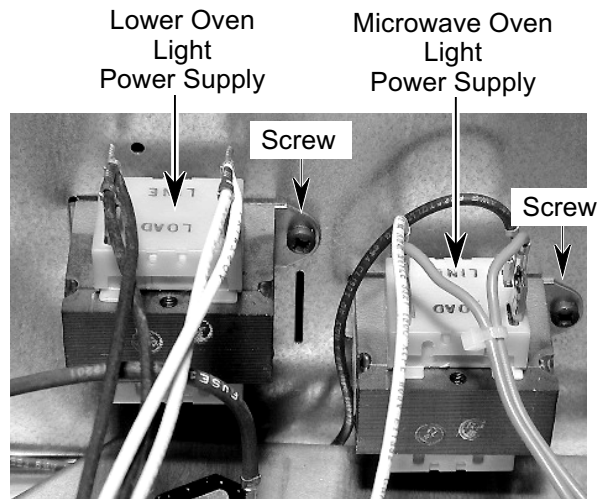

5. **To remove the line fuse & fuseholder:**

- a) Unsnap the line fuse from the fuseholder clips and remove it.
- b) Disconnect the wires from the terminals.
- b) Remove the mounting screws and unhook the tab from the oven cabinet slot.

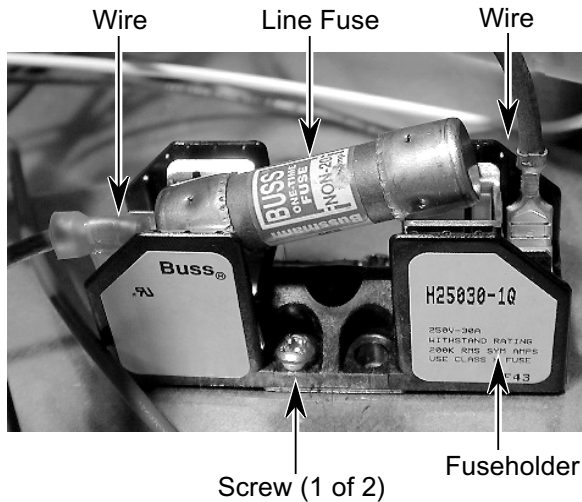

6. **To remove the suppressor board:**

- a) Remove the hex nuts from the black and white wires and remove the wires from the screw terminals.
- b) Remove the mounting screw holding the suppressor board to the terminal strip.

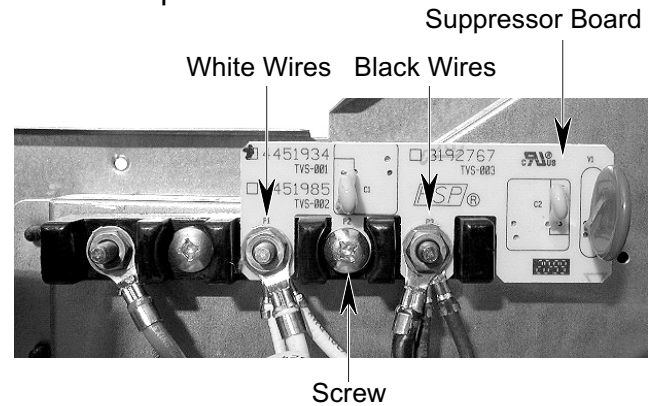

REMOVING THE UPPER BLOWER MOTOR ASSEMBLY

! WARNING

ELECTRICAL SHOCK HAZARD

Disconnect power before servicing.
Replace all panels before operating.
Failure to do so could result in death or electrical shock.

CAUTION: When you work on the microwave/oven combination, be careful when handling the sheet metal parts. Sharp edges may be present, and you can cut yourself if you are not careful.

1. Disconnect the electrical power to the microwave/oven combination.
2. Open the lower oven door.
3. Remove the bottom screw from each of the two side trim pieces (see below).
4. To remove the side trim, pull the bottom out approximately 2", and slide the top down to free it from the control panel.

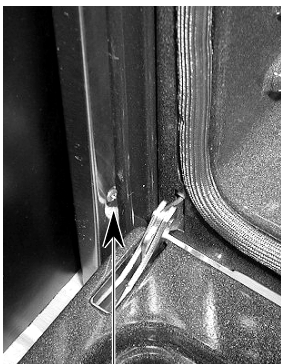

Side Trim Screw
(1 On Each Side)



Pull Out Bottom
Of Side Trim

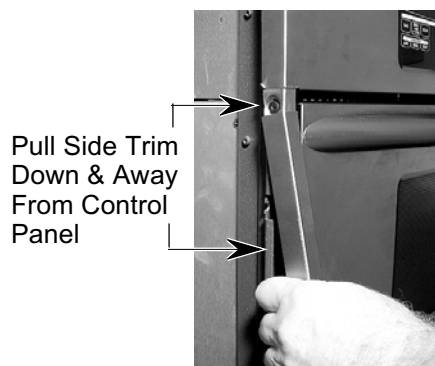

Pull Side Trim
Down & Away
From Control
Panel

5. Remove the four cabinet mounting screws (2 on each side), and pull the oven out of its mounting location so that you can access the back.

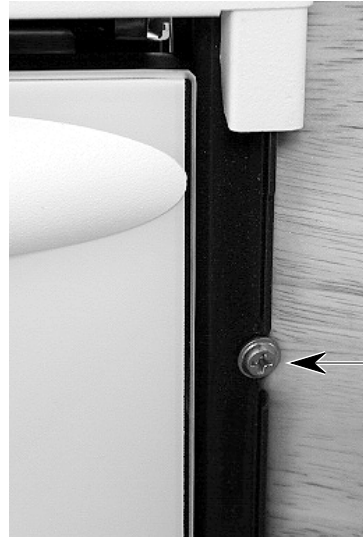

Cabinet Mounting
Screw (2 On Each
Side)

6. Remove the screw from the power conduit clamp and remove the clamp.
7. Remove the 6 screws from the top rear oven cabinet cover.

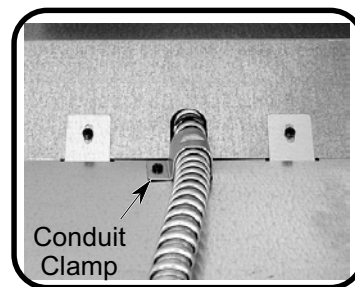

Conduit
Clamp

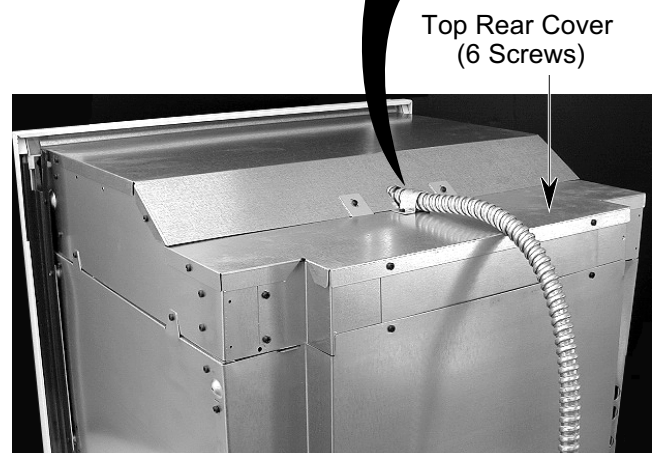

Top Rear Cover
(6 Screws)

8. Remove the two top screws from the rear cover and remove the air vent cover.

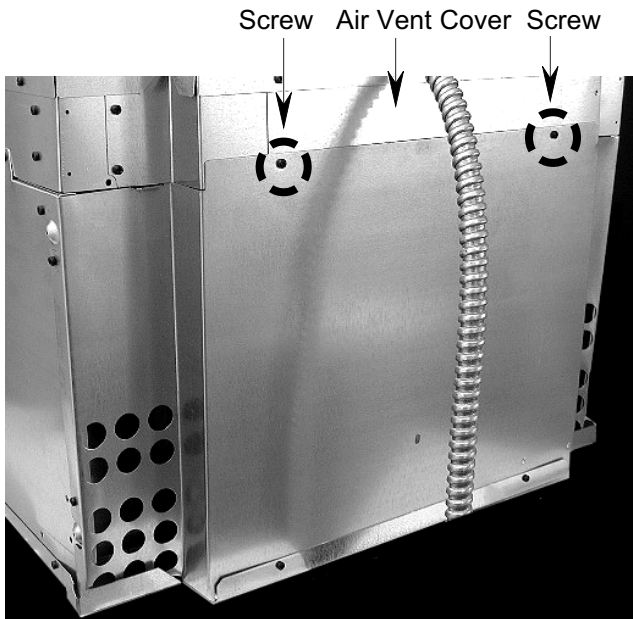

9. Remove the four screws from the blower cover and remove the cover.

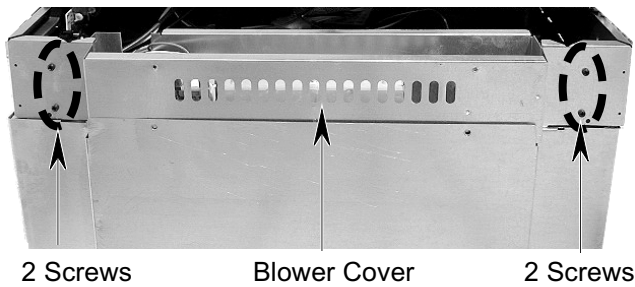

10. Disconnect the two wires from the blower motor terminals.

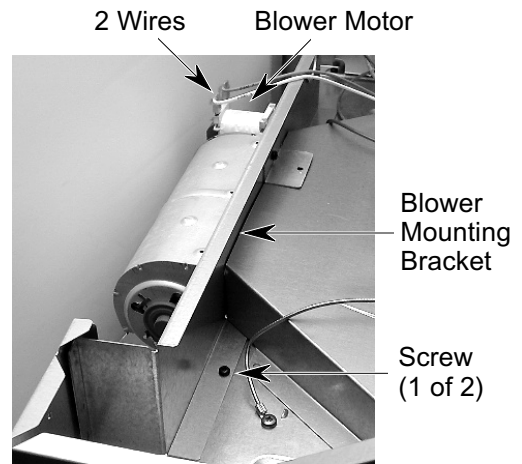

11. Remove the two screws from the blower mounting bracket and remove the bracket and blower.

12. Remove the four mounting screws from the blower motor assembly and remove it from the bracket.

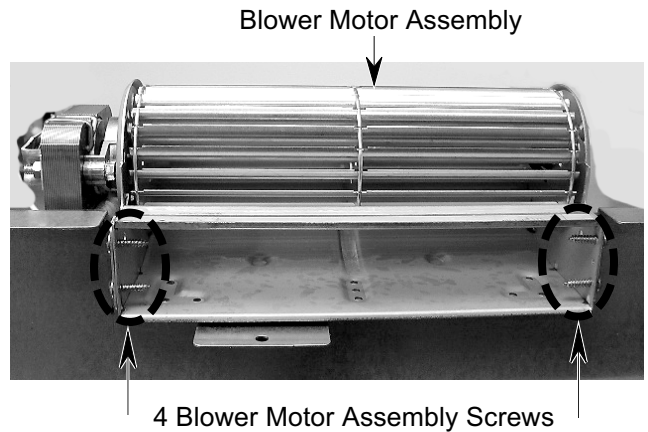

MICROWAVE OVEN COMPONENTS

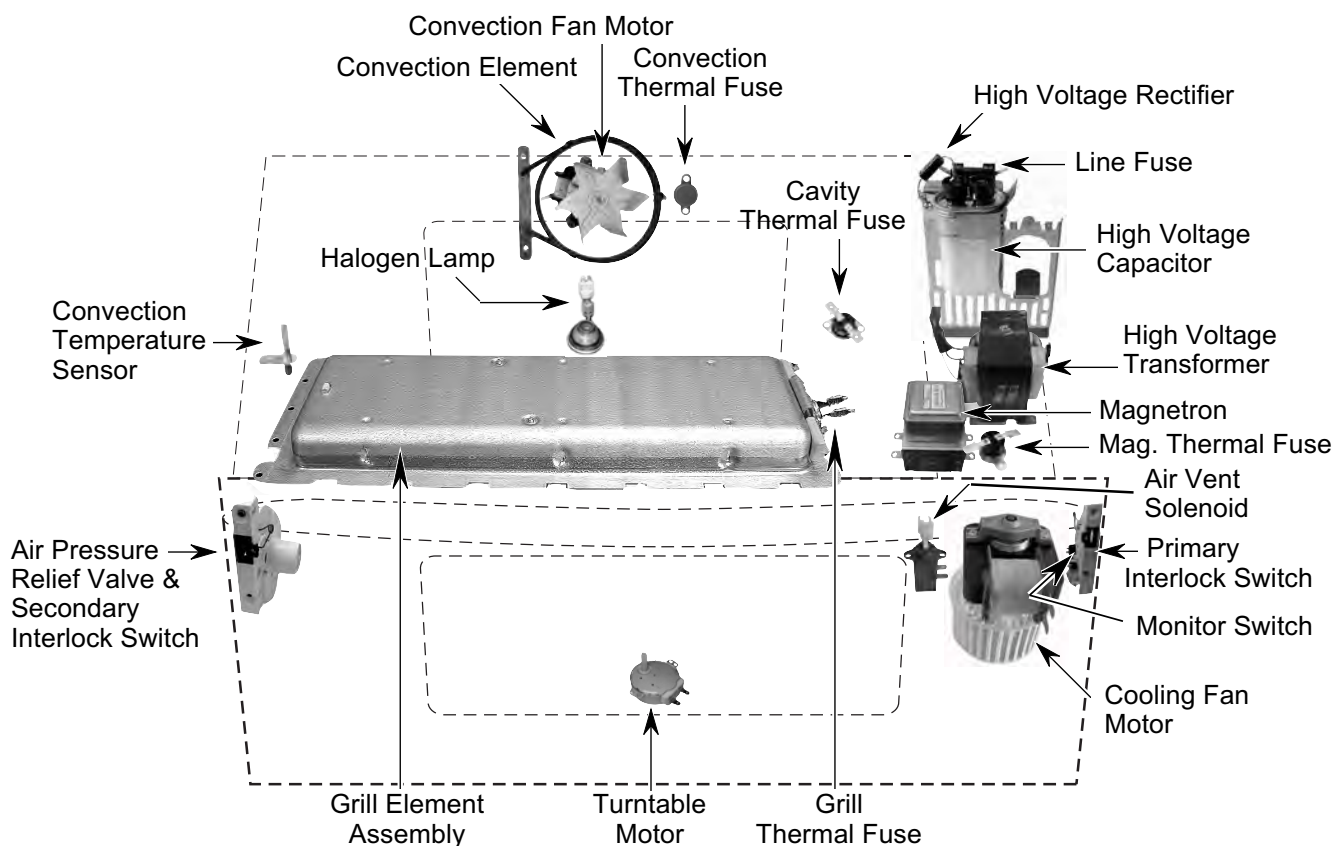

REMOVING THE MICROWAVE OVEN ASSEMBLY

! WARNING

ELECTRICAL SHOCK HAZARD

Disconnect power before servicing.
 Replace all panels before operating.
 Failure to do so could result in death or electrical shock.

CAUTION: When you work on the microwave/oven combination, be careful when handling the sheet metal parts. Sharp edges may be present, and you can cut yourself if you are not careful.

1. Disconnect the electrical power to the microwave/oven combination.

2. Open the microwave oven door and remove the glass turntable and roller assembly from inside the oven cavity. Leave the oven door open.

Turntable & Roller Assembly

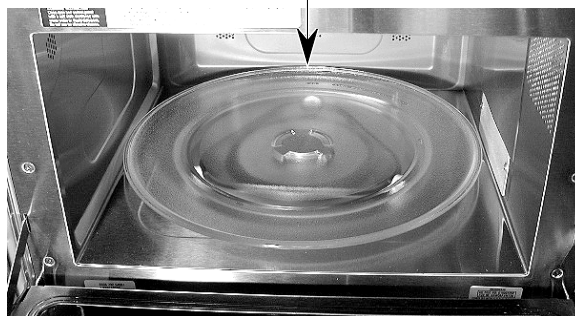

3. Remove the control panel (see page 2-2 steps 1 through 7 for the procedure) and position it out of the way.

- Remove the three screws from the upper air vent and remove the air vent.

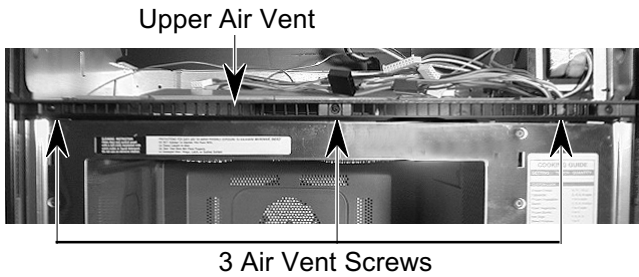

- Remove the four screws from the lower air vent and remove the air vent.

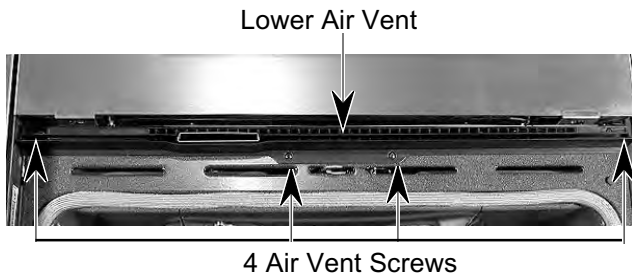

- Remove the two screws from the lower microwave mounting brackets.

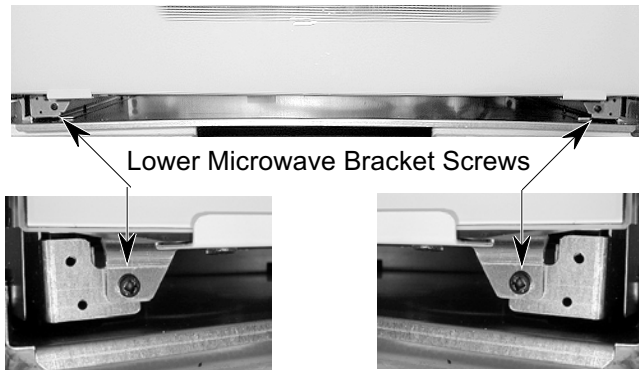

! WARNING

EXCESSIVE WEIGHT HAZARD

Use two or more people to remove and reinstall the microwave oven.
Failure to follow this instruction can result in back, or other injury.

- Close the microwave oven door.
- Pull the microwave oven out of the oven cabinet approximately four inches.

- Disconnect the two red LOAD wires from the microwave light power supply, the 6-pin connector, and the green ground wire in the top of the oven cabinet.

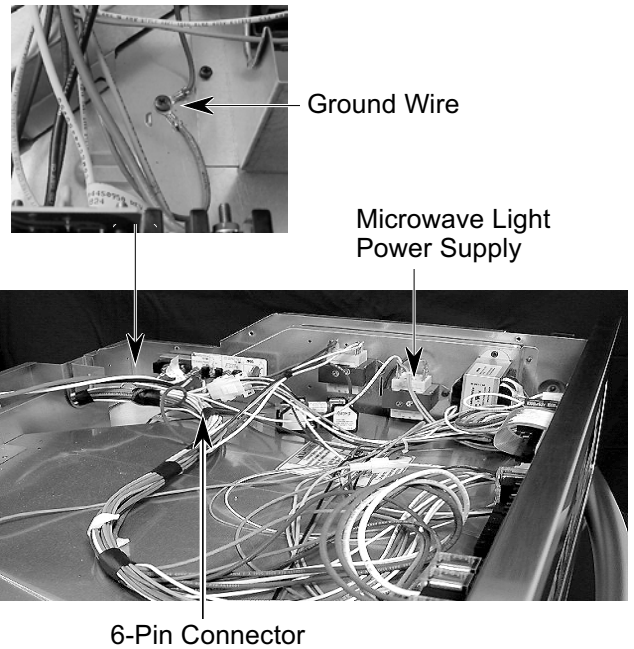

- Slide the plastic grommet and the microwave oven out of the oven cabinet and set the oven on your work surface.

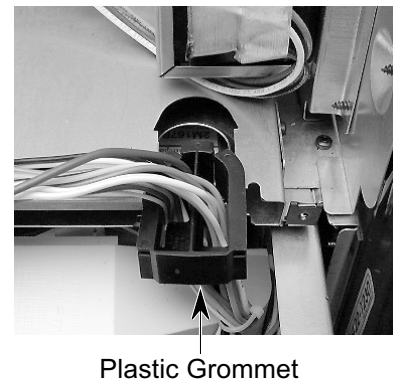

REMOVING THE PRIMARY & SECONDARY INTERLOCK AND MONITOR SWITCHES, AND THE AIR PRESSURE RELIEF VALVE

! WARNING

ELECTRICAL SHOCK HAZARD

Disconnect power before servicing.
 Replace all panels before operating.
 Failure to do so could result in death or electrical shock.

CAUTION: When you work on the microwave/oven combination, be careful when handling the sheet metal parts. Sharp edges may be present, and you can cut yourself if you are not careful.

1. Disconnect the electrical power to the microwave/oven combination.
2. **To remove the secondary interlock switch:**
 - a) Remove the microwave oven from the oven cabinet (see pages 2-8 & 2-9 for the procedure).
 - b) Remove the six screws from the left side panel and remove the panel.

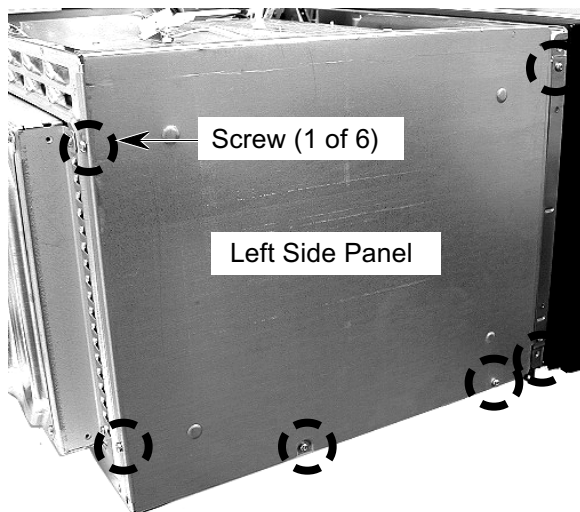

- c) Remove the wires from the switch terminals.

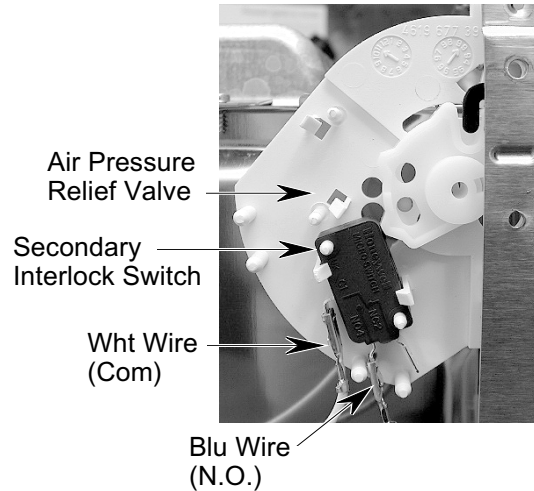

- d) Unclip the switch from the air pressure relief valve. **NOTE:** Be careful when removing the switch. The clips are very fragile and break easily.

3. **To remove the air pressure relief valve:**
 - a) Remove the secondary interlock switch (see step 2 for the procedure).
 - b) Remove the two T-10 torx flat-head screws and remove the relief valve.

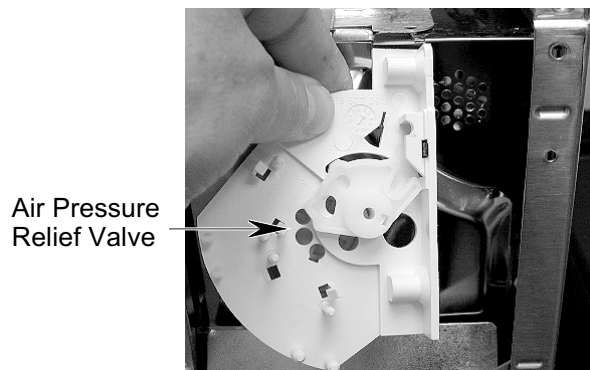

4. To remove the primary interlock and monitor switches:

- a) Pull the microwave oven out of the oven cabinet approximately 6" so you can access the switches (see pages 2-8 & 2-9 for the procedure).
- b) Open the microwave oven door.
- c) Remove the two T-10 torx flat-head screws from the primary interlock and monitor switch bracket.

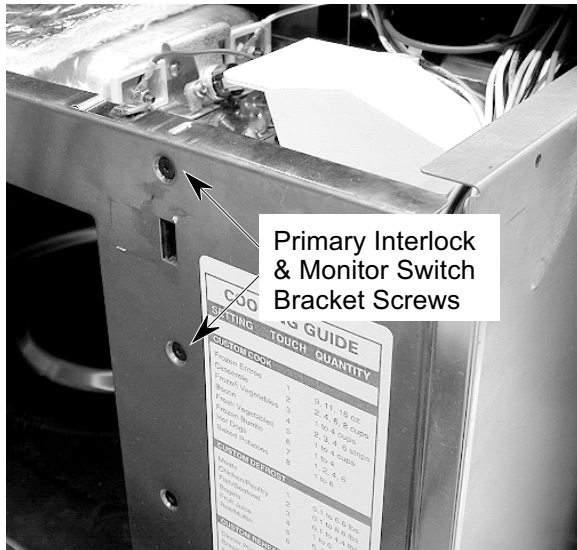

- d) Disconnect the wires from the primary interlock and monitor switch terminals. A switch is mounted on both sides of the bracket.

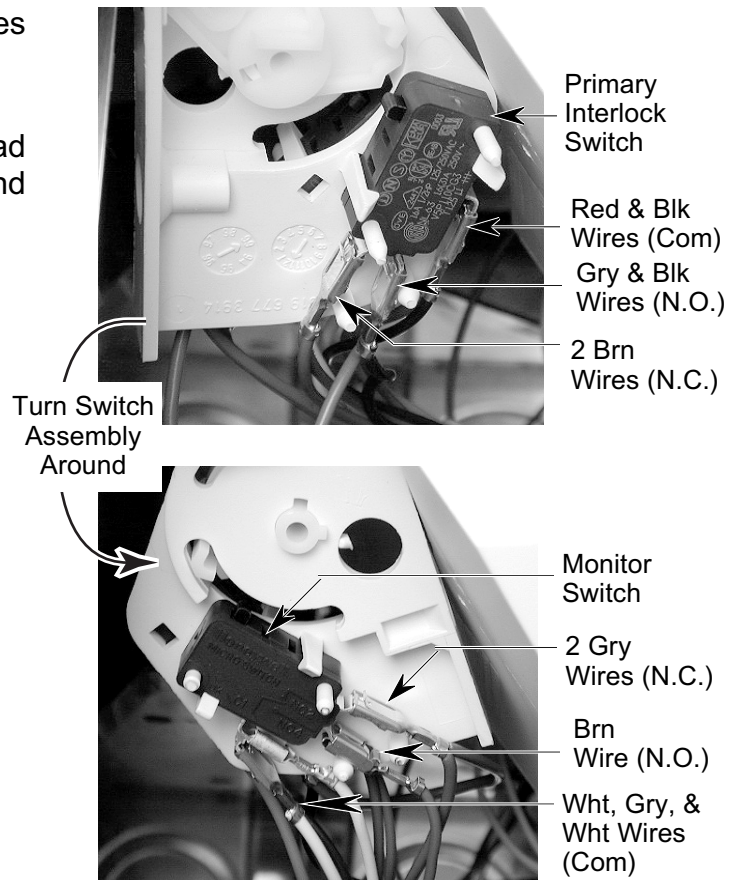

- e) Unclip and remove the primary interlock and monitor switches from the bracket. NOTE: Be careful when removing the switches. The clips are very fragile and break easily.

IMPORTANT NOTE: If safety interlock/monitor switch replacement, or adjustment, is required, you must reconnect and perform a continuity check on the monitor circuit.

REMOVING THE GRILL THERMAL FUSE AND THE GRILL ELEMENT ASSEMBLY

! WARNING

ELECTRICAL SHOCK HAZARD

Disconnect power before servicing.
Replace all panels before operating.
Failure to do so could result in death or electrical shock.

CAUTION: When you work on the microwave/oven combination, be careful when handling the sheet metal parts. Sharp edges may be present, and you can cut yourself if you are not careful.

1. Disconnect the electrical power to the microwave/oven combination.
2. Remove the microwave oven from the oven cabinet (see pages 2-8 & 2-9 for the procedure).

The microwave oven components described on these pages are shown below.

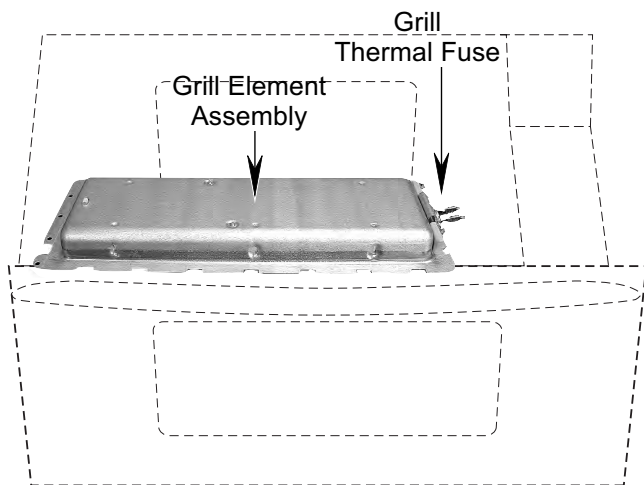

3. To remove the grill thermal fuse:

- a) Disconnect the two wires from the terminals.

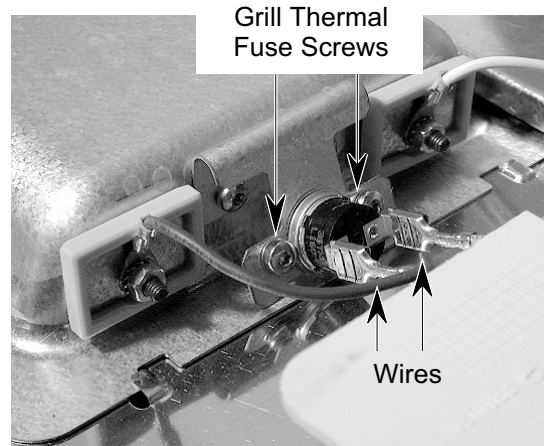

- b) Remove the two thermal fuse mounting screws.

4. To remove the grill element assembly:

- a) Remove the two T-10 torx screws from the plate over the left end of the grill element bracket and remove the plate.

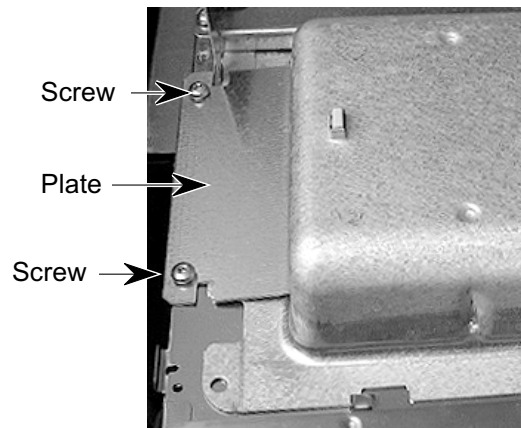

- b) Remove the two T-10 torx screws from the bracket over the left end of the grill element assembly and raise the bracket slightly.

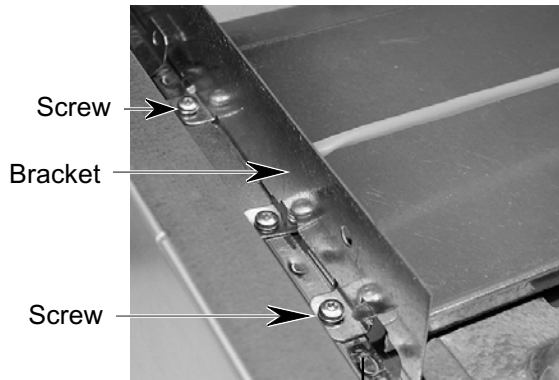

- c) Slide the grill element assembly to the left and release the slots from the locking tabs. NOTE: It may take a moderate amount of force to do this.

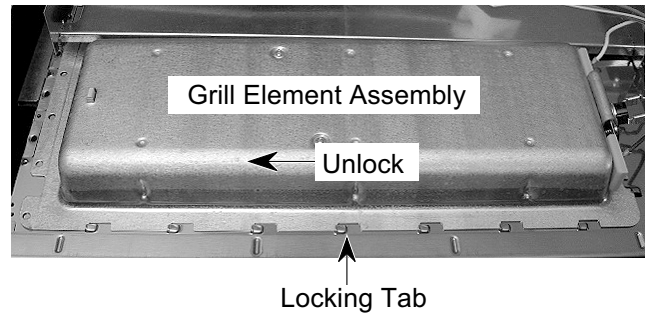

- d) Remove the two T-10 torx screws from the grill thermal fuse bracket and remove the fuse and bracket.

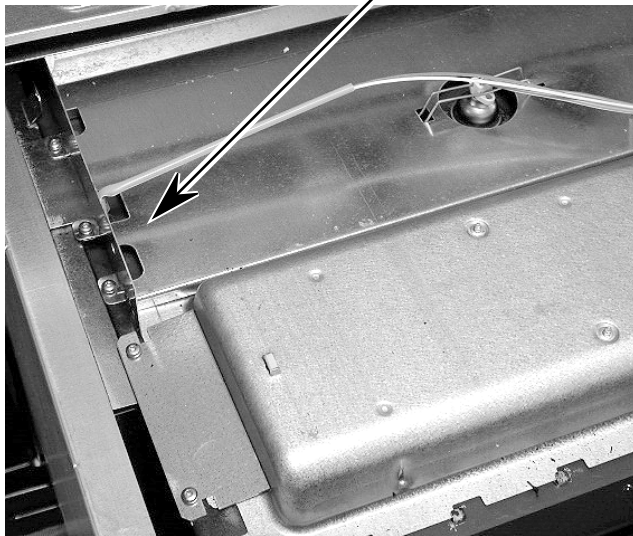

Thermal Fuse Bracket Screws

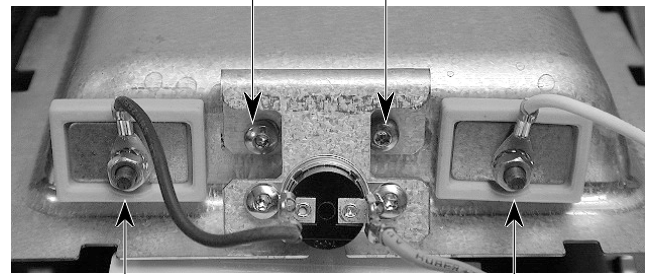

Element Hex Nut

Element Hex Nut

- e) Remove the two hex nuts from the grill element studs and remove the wires.

REMOVING THE CONVECTION TEMPERATURE SENSOR, THE HALOGEN LAMP, AND THE CAVITY THERMAL FUSE

! WARNING

ELECTRICAL SHOCK HAZARD

Disconnect power before servicing.
Replace all panels before operating.
Failure to do so could result in death or electrical shock.

CAUTION: When you work on the microwave/oven combination, be careful when handling the sheet metal parts. Sharp edges may be present, and you can cut yourself if you are not careful.

1. Disconnect the electrical power to the microwave/oven combination.
2. Remove the microwave oven from the oven cabinet (see pages 2-8 & 2-9 for the procedure).

The microwave oven components described on these pages are shown below.

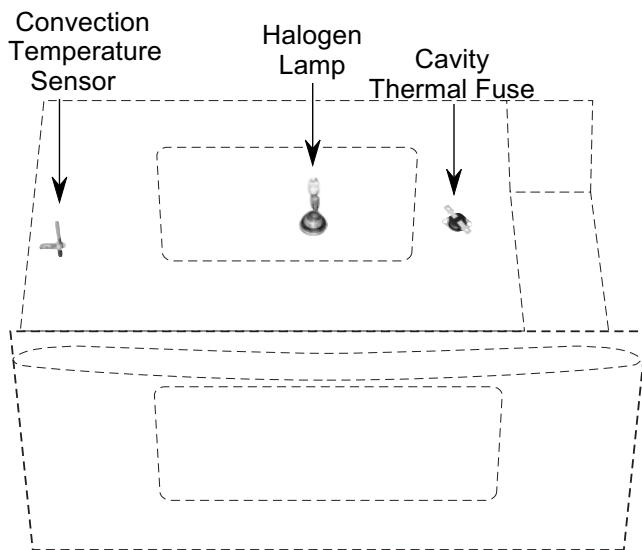

3. To remove the convection temperature sensor:

- a) Remove the two T-10 torx screws from the plate over the left end of the grill element bracket and remove the plate.

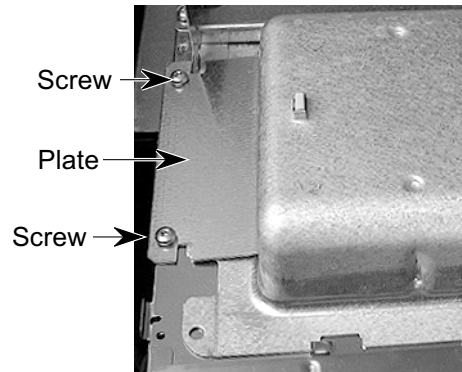

- b) Remove the two T-10 torx screws from the bracket over the left end of the grill element assembly and raise the bracket.

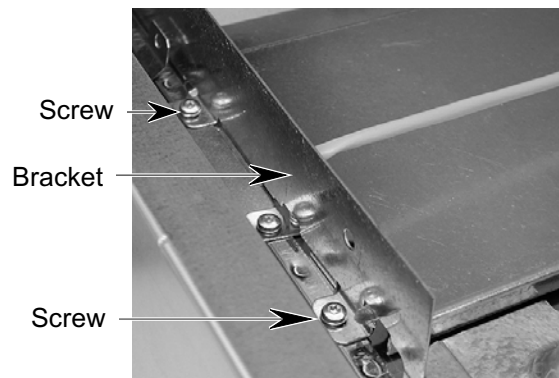

- c) Remove the T-10 torx screw from the sensor.

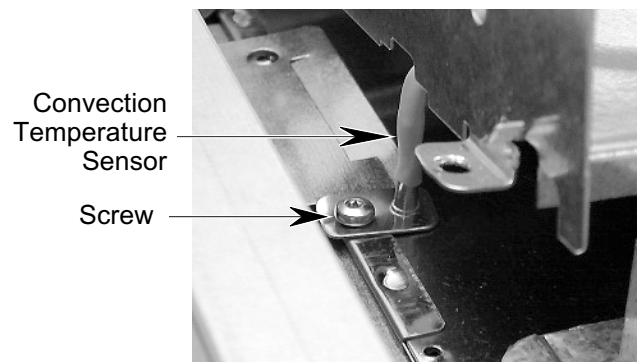

- d) Remove the two sensor wires from the harness.

4. **To remove the halogen lamp:**

- a) Unclip the wire retainer and remove it.

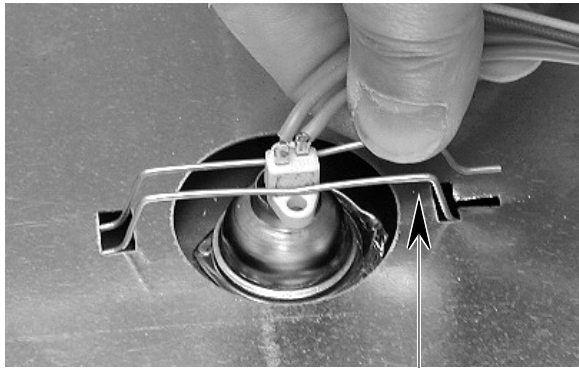

Wire Retainer

- b) Remove the lamp from the holder and remove the wires from the harness.

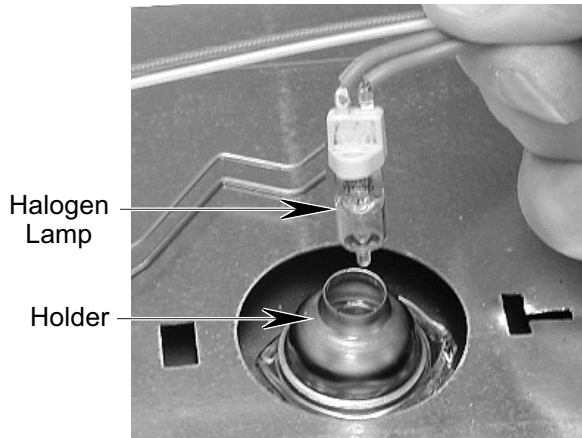

5. **To remove the cavity thermal fuse:**

- a) Disconnect the wires from the terminals.
b) Remove the T-10 torx screw from the cavity thermal fuse.

Cavity Thermal Fuse Screw

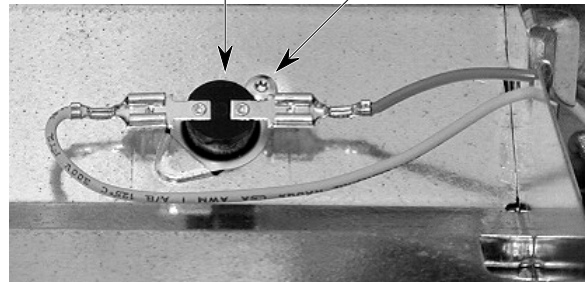

REMOVING THE CONVECTION THERMAL FUSE, CONVECTION ELEMENT, AND CONVECTION FAN MOTOR

! WARNING

ELECTRICAL SHOCK HAZARD

Disconnect power before servicing.
Replace all panels before operating.
Failure to do so could result in death or electrical shock.

CAUTION: When you work on the microwave/oven combination, be careful when handling the sheet metal parts. Sharp edges may be present, and you can cut yourself if you are not careful.

1. Disconnect the electrical power to the microwave/oven combination.
2. Remove the microwave oven from the oven cabinet (see pages 2-8 & 2-9 for the procedure).
3. Position the microwave oven with the back facing you.
4. **To remove the convection thermal fuse:**
 - a) Disconnect the wires from the terminals.
 - b) Remove the two T-10 torx screws.

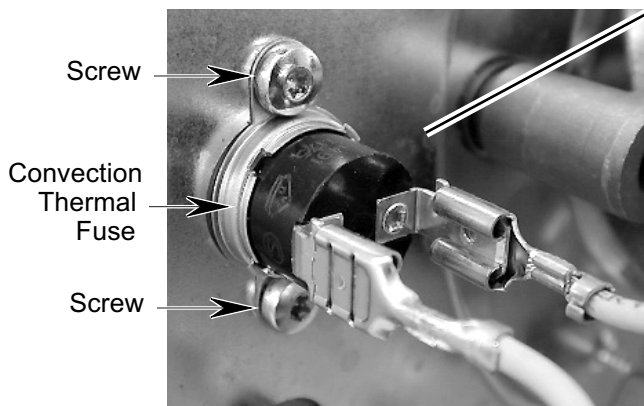

5. **To remove the convection element:**
 - a) Disconnect the wires from the terminals.
 - b) Remove the four T-10 torx screws from the mounting cover.

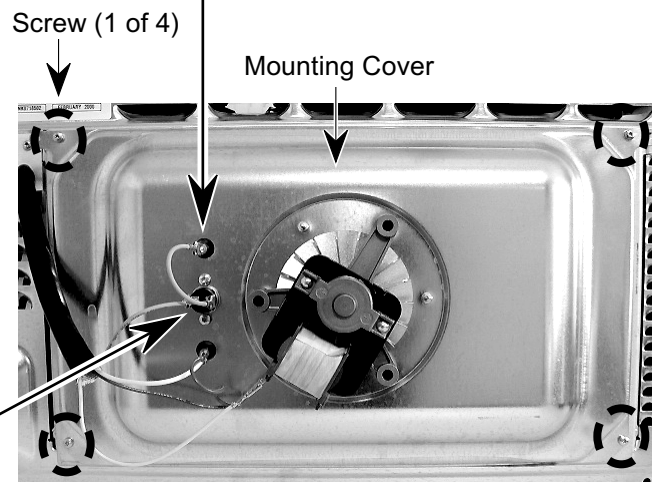
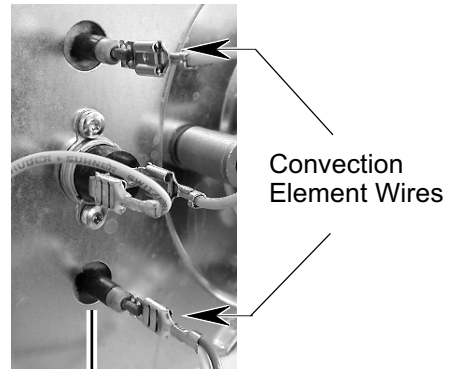

Back Of Oven

- c) Turn the cover around so that the convection element faces you and remove the three T-10 torx screws from the element.

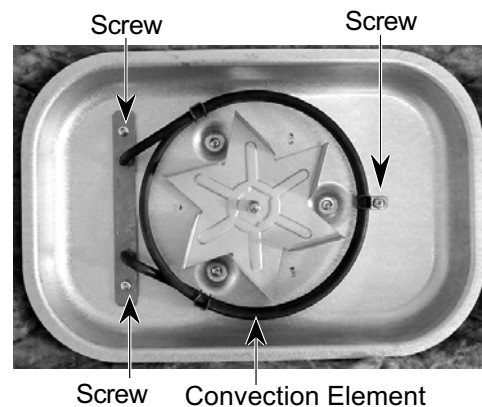

6. **To remove the convection fan motor:**

- a) Remove the convection element (see step 5). NOTE: It is not necessary to remove the convection element to remove the fan motor. However, there is a possibility of damaging the element while removing the motor, so it is advisable to remove it.
- b) Disconnect the wires from the convection fan motor terminals.

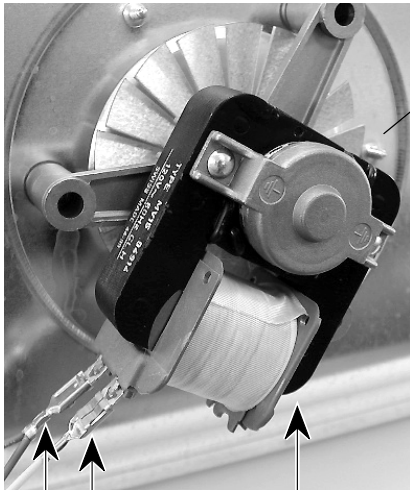

Wires Convection Fan Motor

CAUTION: Be very careful when handling the fan in the next step. The edges are very sharp.

- c) Remove the acorn nut from the fan motor shaft and remove the fan and flat washer beneath it.

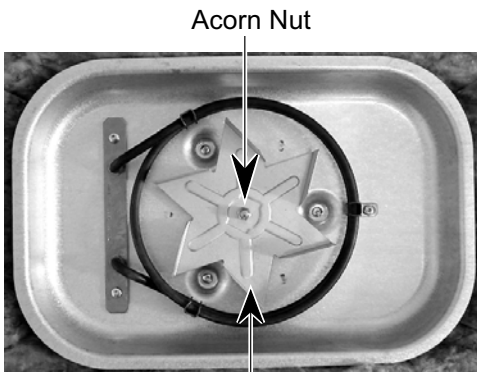

Acorn Nut
Convection Motor Fan

- d) Remove the three T-10 torx screws from the insulation cover and remove the cover and insulation.

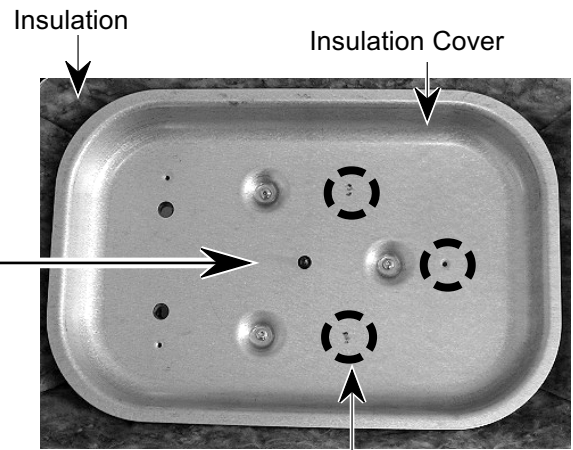

Cover Screws (1 of 3)

- e) Unsnap the e-ring from the motor shaft and remove the ring and flat washer.

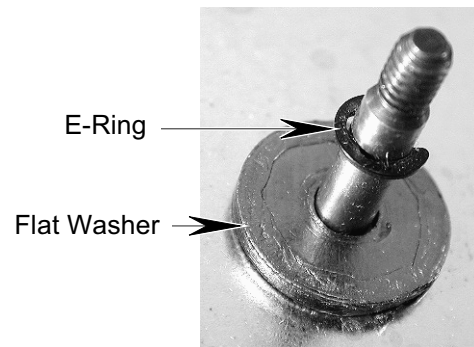

E-Ring
Flat Washer

- f) Remove the three 5/32" allen screws from the motor and remove the motor from the cover.

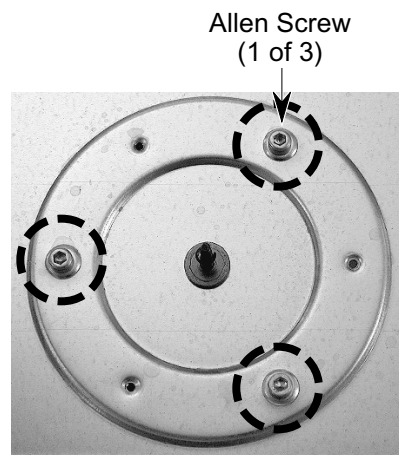

Allen Screw
(1 of 3)

REMOVING THE COOLING FAN MOTOR & AIR VENT SOLENOID

! WARNING

ELECTRICAL SHOCK HAZARD

Disconnect power before servicing.
Replace all panels before operating.
Failure to do so could result in death or electrical shock.

CAUTION: When you work on the microwave/oven combination, be careful when handling the sheet metal parts. Sharp edges may be present, and you can cut yourself if you are not careful.

1. Disconnect the electrical power to the microwave/oven combination.
2. Remove the microwave oven from the oven cabinet (see pages 2-8 & 2-9 for the procedure).
3. Open the microwave oven door and remove the turntable and the spindle from the turntable motor shaft.
4. Remove the right side panel (see step 2b on page 2-10 for the procedure).
5. Position the microwave oven on its left side.
6. Remove the four T-10 torx screws from the cooling fan housing.

Torx Screws (1 of 4) Cooling Fan Housing

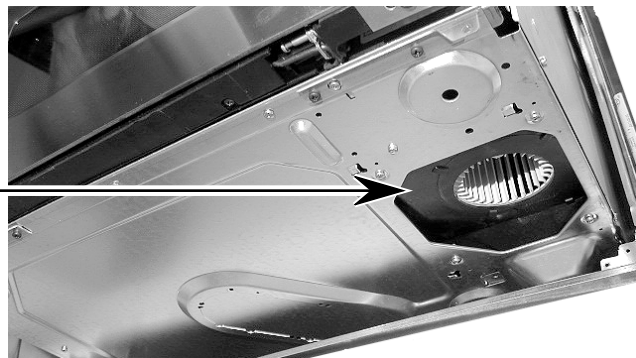
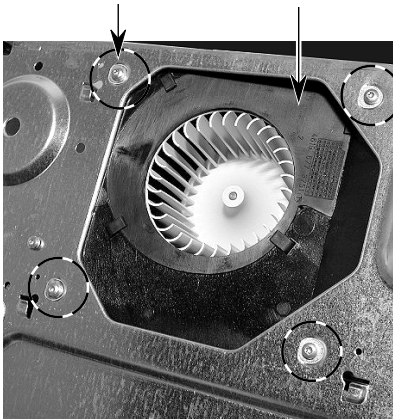

7. Position the unit with the high voltage component side facing you.
8. Pull the cooling fan assembly out of the unit.
9. **To remove the cooling fan motor:**
 - a) Disconnect the wires from the terminals.

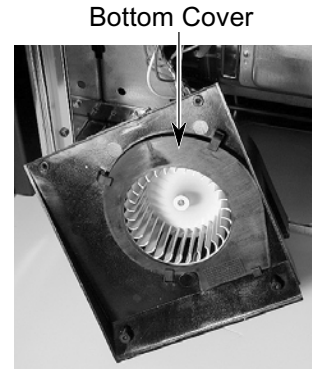
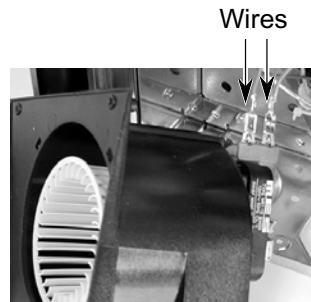

- b) Unclip the bottom cover from the cooling fan housing and remove the cover.
- c) Pull the fan off the motor shaft.

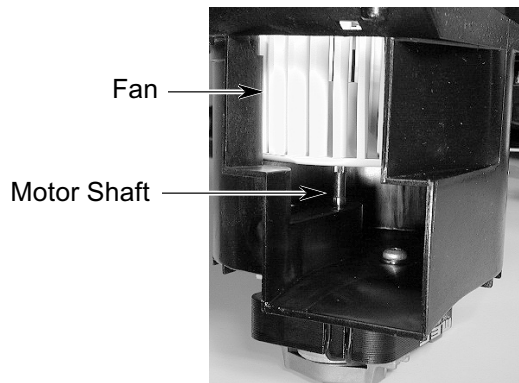

- d) Remove the T-10 torx screws from the fan motor and remove the motor from the housing.



The microwave oven component described on this page is shown below.

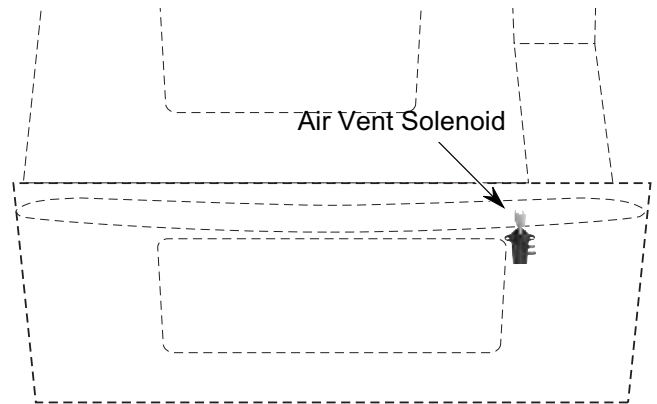

10. To remove the air vent solenoid:

- a) Disconnect the wires from the terminals.
- b) Remove the T-10 torx screw.
- c) Unclip the actuator from the solenoid shaft.

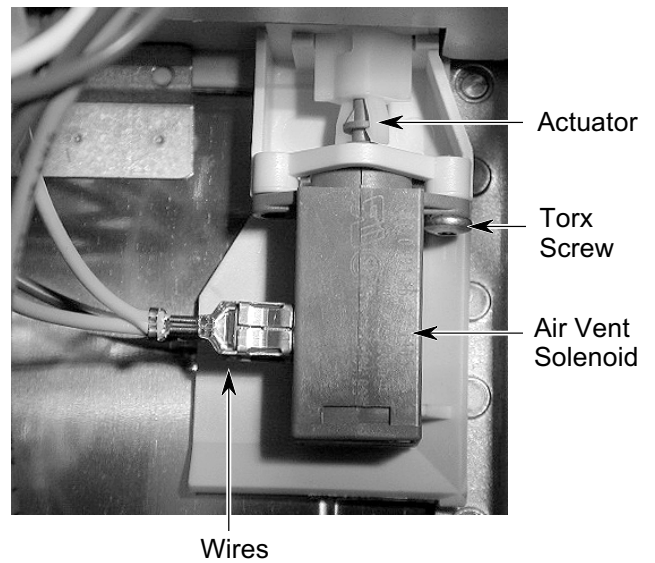

REMOVING THE MAGNETRON THERMAL FUSE AND THE MAGNETRON

! WARNING

ELECTRICAL SHOCK HAZARD

Disconnect power before servicing.
Replace all panels before operating.
Failure to do so could result in death or electrical shock.

CAUTION: When you work on the microwave/oven combination, be careful when handling the sheet metal parts. Sharp edges may be present, and you can cut yourself if you are not careful.

1. Disconnect the electrical power to the microwave/oven combination.
2. Remove the microwave oven from the oven cabinet (see pages 2-8 & 2-9 for the procedure).
3. Open the microwave oven door and remove the turntable and rollers.
4. Remove the right side panel (see step 2b on page 2-10 for the procedure).

CAUTION: Discharge the high voltage capacitor terminals with a 20,000 Ω resistor to chassis ground.

The microwave oven components described on these pages are shown below.

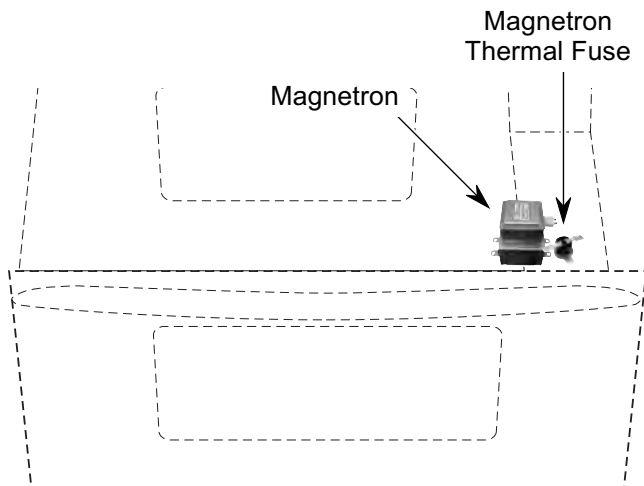

5. To remove the magnetron thermal fuse:

- a) Remove the wires from the thermal fuse cover clips.
- b) Remove the T-10 torx screw from the thermal fuse cover and remove the cover.

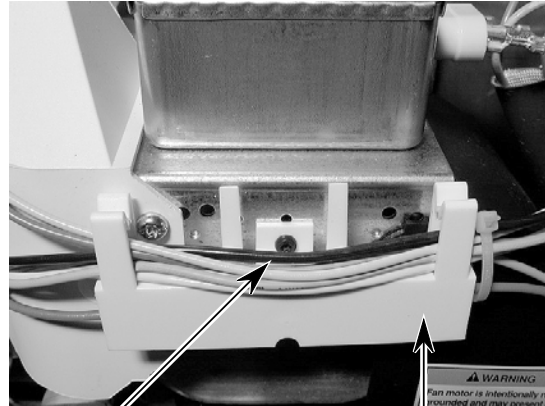

Screw Thermal Fuse Cover

- c) Remove the remaining T-10 torx screw from the thermal fuse.

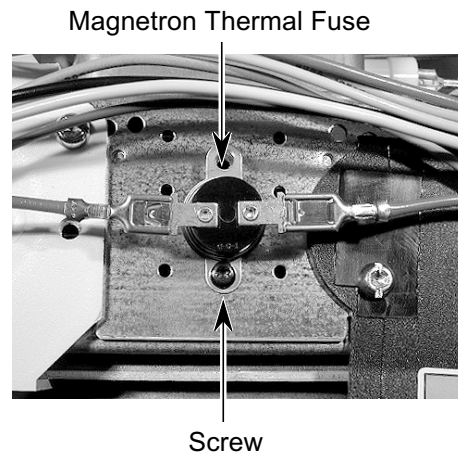

6. **To remove the magnetron:**
 - a) Remove the magnetron thermal fuse (see step 5).
 - b) Remove the T-16 torx screws (1 each) from the left and right air ducts.

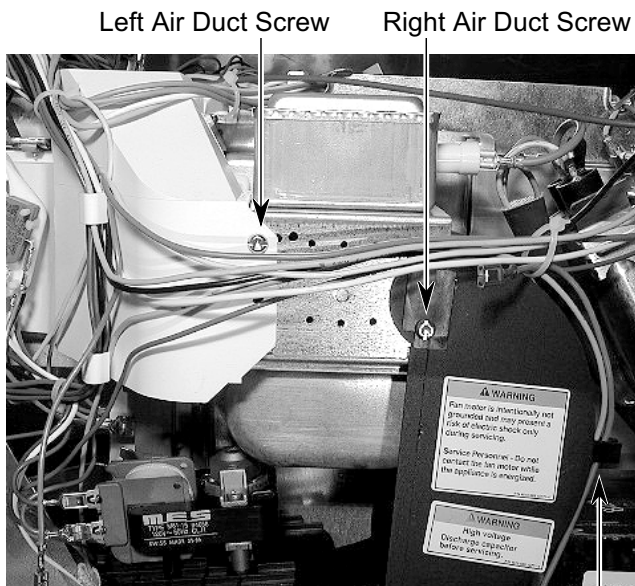

- c) Unclip the two wires from the right air duct and remove the duct.

- d) Disconnect the two filament wires from the magnetron terminals.

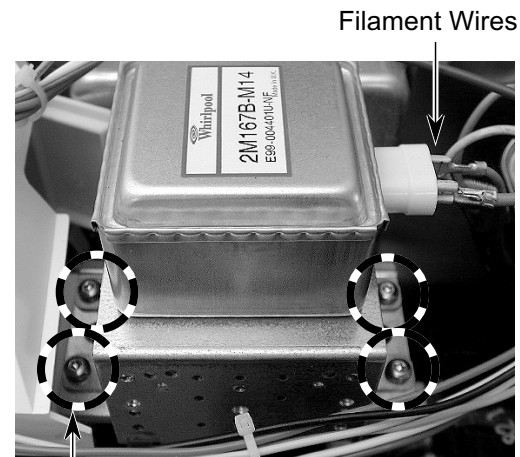

Screw (1 of 4)

- e) Remove the four T-16 magnetron torx screws and remove the magnetron. **NOTE:** Move the left air duct back far enough to access the magnetron screws.

IMPORTANT REASSEMBLY NOTE: When you mount the magnetron, loosely install the four screws, and then tighten them in a cross-tightening (opposite corner) sequence. Make sure that the base of the magnetron stays parallel with the mounting surface so that it is not tilted; otherwise, it may not work properly.

REMOVING THE HIGH VOLTAGE TRANSFORMER

! WARNING

ELECTRICAL SHOCK HAZARD

Disconnect power before servicing.
Replace all panels before operating.
Failure to do so could result in death or electrical shock.

CAUTION: When you work on the microwave/oven combination, be careful when handling the sheet metal parts. Sharp edges may be present, and you can cut yourself if you are not careful.

1. Disconnect the electrical power to the microwave/oven combination.
2. Remove the microwave oven from the oven cabinet (see pages 2-8 & 2-9 for the procedure).
3. Remove the right side panel (see step 2b on page 2-10 for the procedure).

CAUTION: Discharge the high voltage capacitor terminals with a 20,000 Ω resistor to chassis ground.

The microwave oven component described on these pages is shown below.

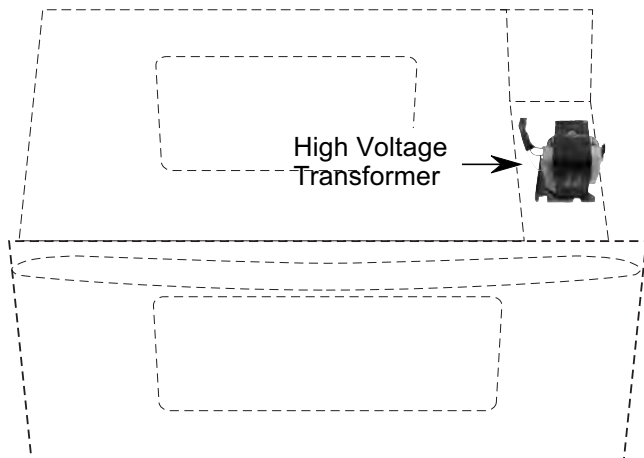

4. Remove the T-16 torx screw from the air duct, unclip the two wires, and remove the duct.

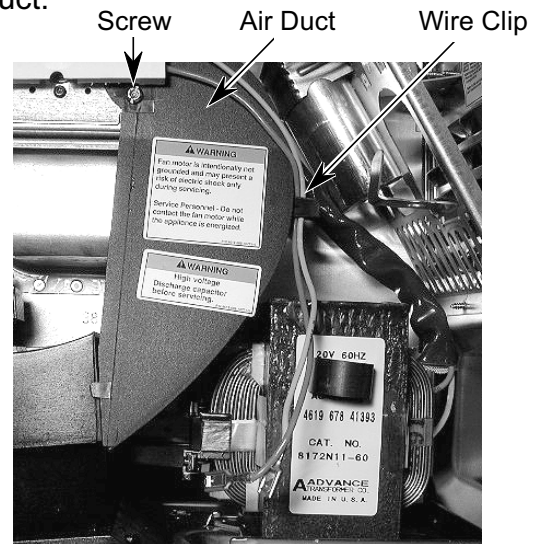

5. Disconnect the two wires from the primary terminals of the high voltage transformer, and the three secondary wires from the magnetron, and high voltage capacitor terminals.

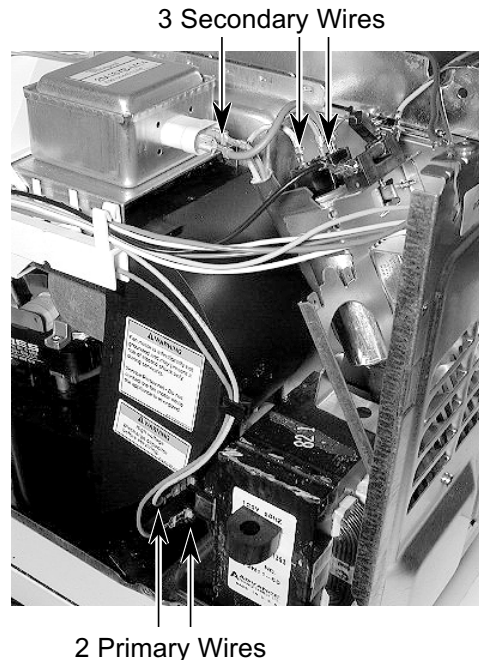

6. Remove the two T-10 torx screws from the high voltage transformer, then pull the two base tabs out of the chassis, and remove the high voltage transformer.

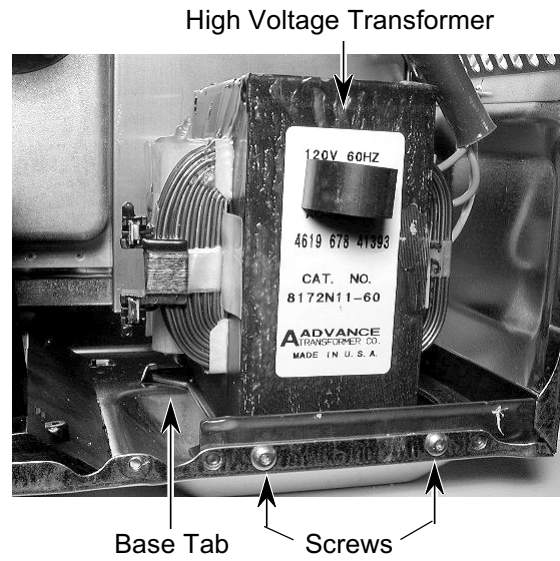

REMOVING THE LINE FUSE & FUSEHOLDER, THE HIGH VOLTAGE RECTIFIER, & HIGH VOLTAGE CAPACITOR

! WARNING

ELECTRICAL SHOCK HAZARD

Disconnect power before servicing.
 Replace all panels before operating.
 Failure to do so could result in death or electrical shock.

CAUTION: When you work on the microwave/oven combination, be careful when handling the sheet metal parts. Sharp edges may be present, and you can cut yourself if you are not careful.

1. Disconnect the electrical power to the microwave/oven combination.
2. Remove the microwave oven from the oven cabinet (see pages 2-8 & 2-9 for the procedure).
3. Remove the right side panel (see step 2b on page 2-10 for the procedure).

CAUTION: Discharge the high voltage capacitor terminals with a 20,000 Ω resistor to chassis ground.

The microwave oven components described on these pages are shown below.

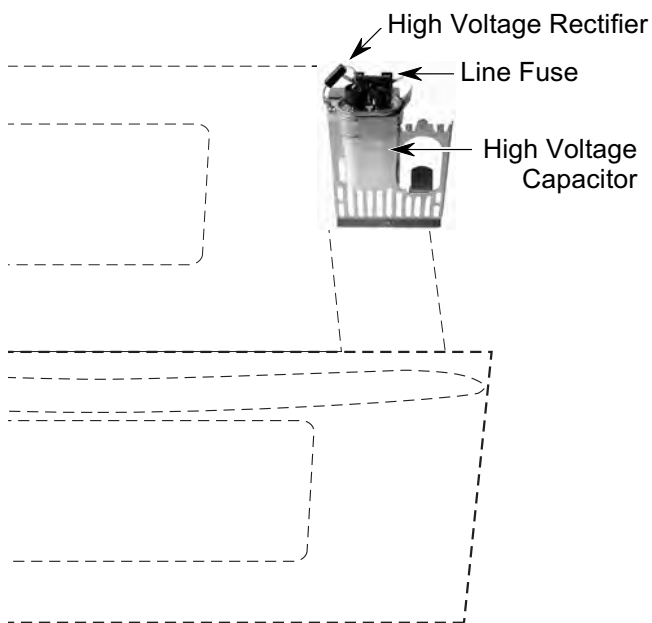

4. To remove the line fuse and fuseholder:
 - a) Remove the line fuse from the fuseholder.
 - b) Remove the wires from the fuseholder terminals.
 - c) Remove the T-10 torx screw from the fuseholder.

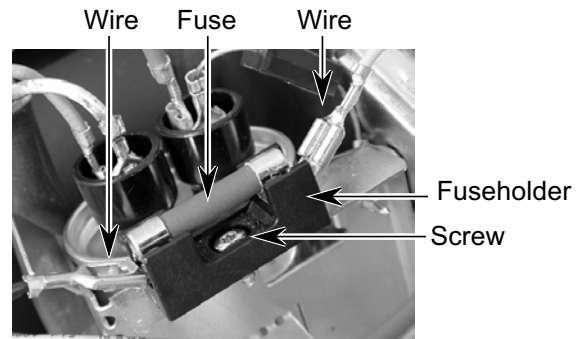

5. To remove the high voltage rectifier and high voltage capacitor:
 - a) Remove the wires from the fuseholder and high voltage capacitor terminals.

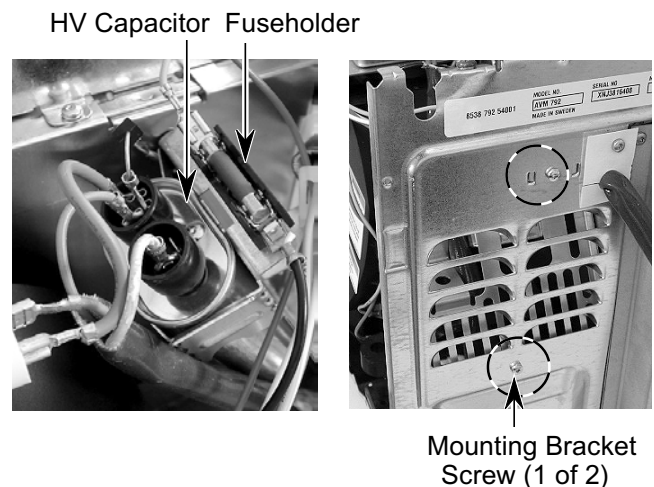

- b) Remove the mounting bracket screws from the rear panel.

- c) Unclip the wires from the mounting bracket clip.

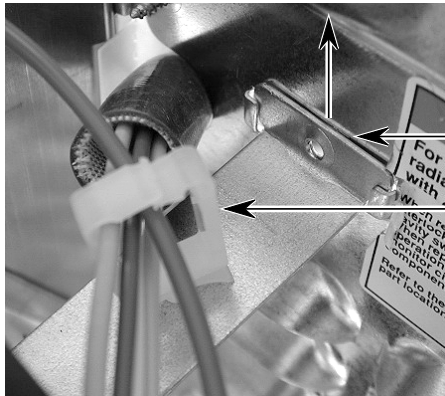

Bracket Arm

Wire Clip

- d) Lift the arm out of the rear panel track, and remove the mounting bracket assembly.

- e) Remove the high voltage rectifier lead from the high voltage capacitor terminal.
- f) Remove the mounting screw from the capacitor clamp and remove the high voltage rectifier and capacitor from the mounting bracket.

High Voltage Capacitor

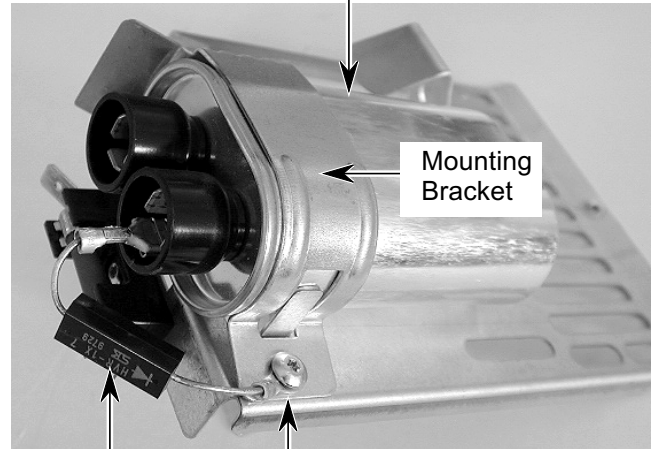

Mounting Bracket

High Voltage Rectifier

Clamp Screw

REMOVING THE TURNTABLE MOTOR

! WARNING

ELECTRICAL SHOCK HAZARD

Disconnect power before servicing.
Replace all panels before operating.
Failure to do so could result in death or electrical shock.

CAUTION: When you work on the microwave/oven combination, be careful when handling the sheet metal parts. Sharp edges may be present, and you can cut yourself if you are not careful.

1. Disconnect the electrical power to the microwave/oven combination.
2. Remove the microwave oven from the oven cabinet (see pages 2-8 & 2-9 for the procedure).
3. Open the microwave oven door and remove the turntable and rollers.
4. Pull the spindle off the turntable motor shaft.
5. Position the microwave oven on its left side.
6. Use a pair of wire cutters and cut the metal between the two holes at the four indicated locations on the turntable motor knockout, and remove it.

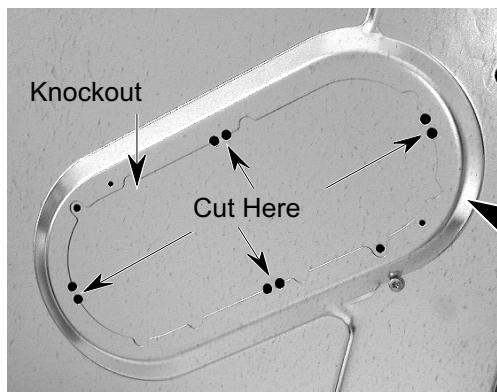

7. Remove the T-10 torx screws from the turntable motor and remove the motor.

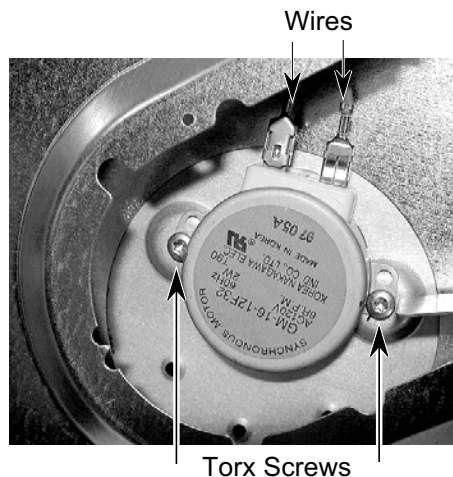

8. Disconnect the wires from the turntable motor terminals.

REASSEMBLY NOTE: Use two #6 x 1/4" screws to mount the knockout over the turntable motor cutout.

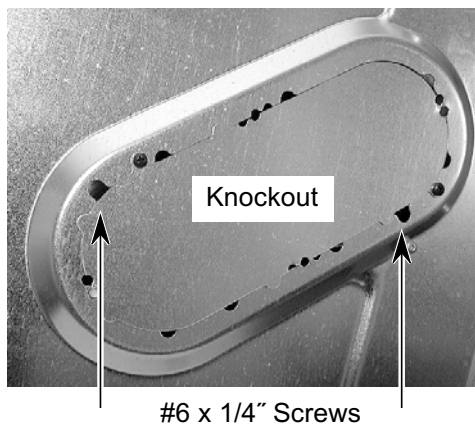

REMOVING THE OVEN DOOR HANDLE & FRONT DOOR GLASS

! WARNING

ELECTRICAL SHOCK HAZARD

Disconnect power before servicing.
Replace all panels before operating.
Failure to do so could result in death or electrical shock.

CAUTION: When you work on the microwave/oven combination, be careful when handling the sheet metal parts. Sharp edges may be present, and you can cut yourself if you are not careful.

1. Disconnect the electrical power to the microwave/oven combination.
2. Remove the microwave oven from the oven cabinet (see pages 2-8 & 2-9 for the procedure).
3. Remove the left and right side panels from the microwave (see step 2b on page 2-10 for the procedure).
4. Remove the screws (1 each) from the two clips at the bottom of the door and remove the clips.

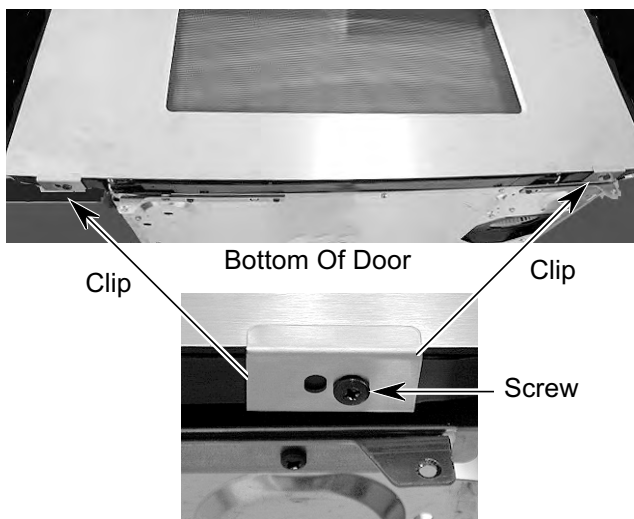

CAUTION: When you remove the front door glass and handle in the next step, be careful when you remove the two screws that hold the assembly together. Hold the door open while you remove the screws; otherwise the door will spring closed. Also, be careful not to drop the glass and handle assembly when you remove the screws.

5. Open the oven door and remove the two screws from the inside of the door panel, then remove the front door glass and handle from the door, and carefully close the oven door.

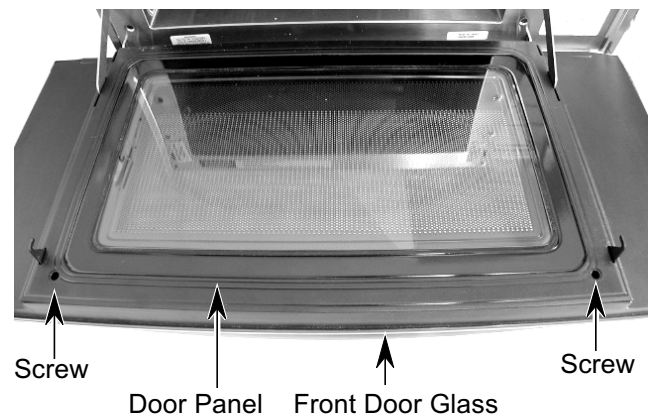

6. Remove the four screws from the handle support bracket, and remove the handle and bracket from the front door glass.

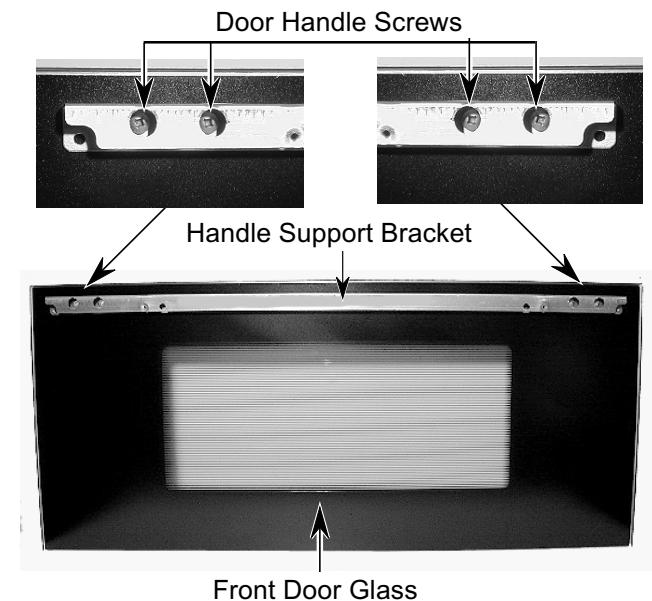

REMOVING THE OVEN DOOR & THE INNER GLASS

! WARNING

ELECTRICAL SHOCK HAZARD

Disconnect power before servicing.
Replace all panels before operating.
Failure to do so could result in death or electrical shock.

CAUTION: When you work on the microwave/oven combination, be careful when handling the sheet metal parts. Sharp edges may be present, and you can cut yourself if you are not careful.

1. Disconnect the electrical power to the microwave/oven combination.
2. Remove the microwave oven from the oven cabinet (see pages 2-8 & 2-9 for the procedure).
3. Remove the left and right side panels from the microwave (see step 2b on page 2-10 for the procedure).

NOTE: The inner door glass cannot be replaced separately. The oven door and inner glass must be replaced as an assembly.

4. Remove the T-10 torx shoulder screws from the door stops (1 on each side).

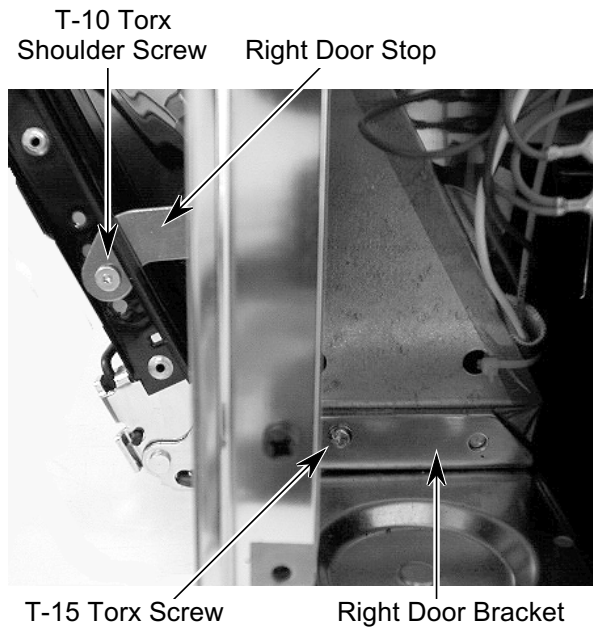

5. Remove the T-15 torx screws from the sides of the door brackets (1 on each side).
6. Remove the two bottom screws from the door panel and remove the panel.

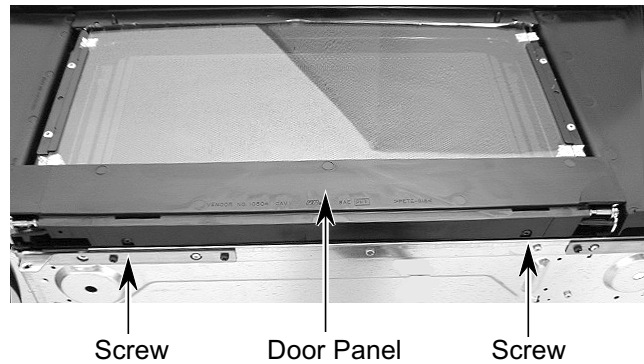

Bottom Of Unit

7. Remove the four indicated T-10 torx screws from the bottom of the door brackets.

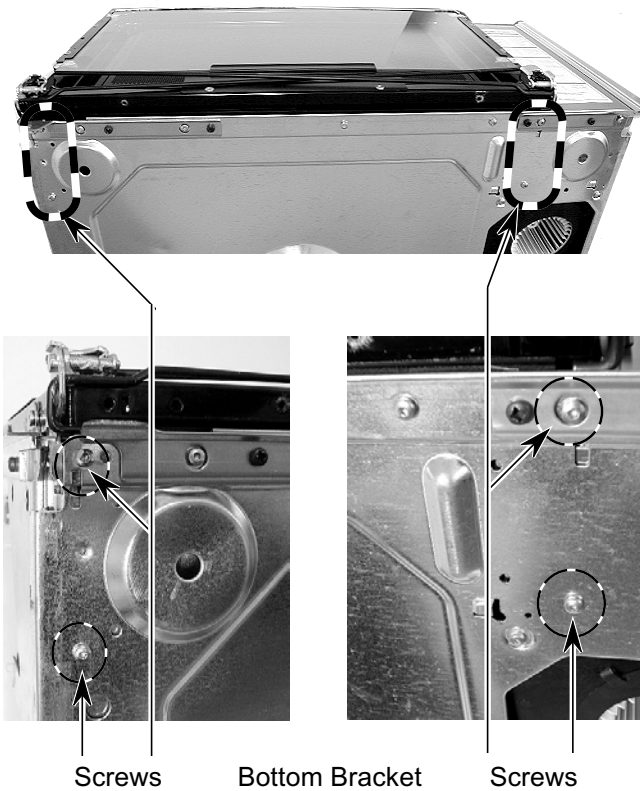

8. Pull the brackets out of the oven slots and remove the door assembly from the microwave.



9. If you are replacing the oven door and inner glass assembly, remove the front door glass and the handle (see page 2-27 for the procedure).

LOWER OVEN COMPONENTS

Components Accessible From The Front



Components Accessible From The Rear

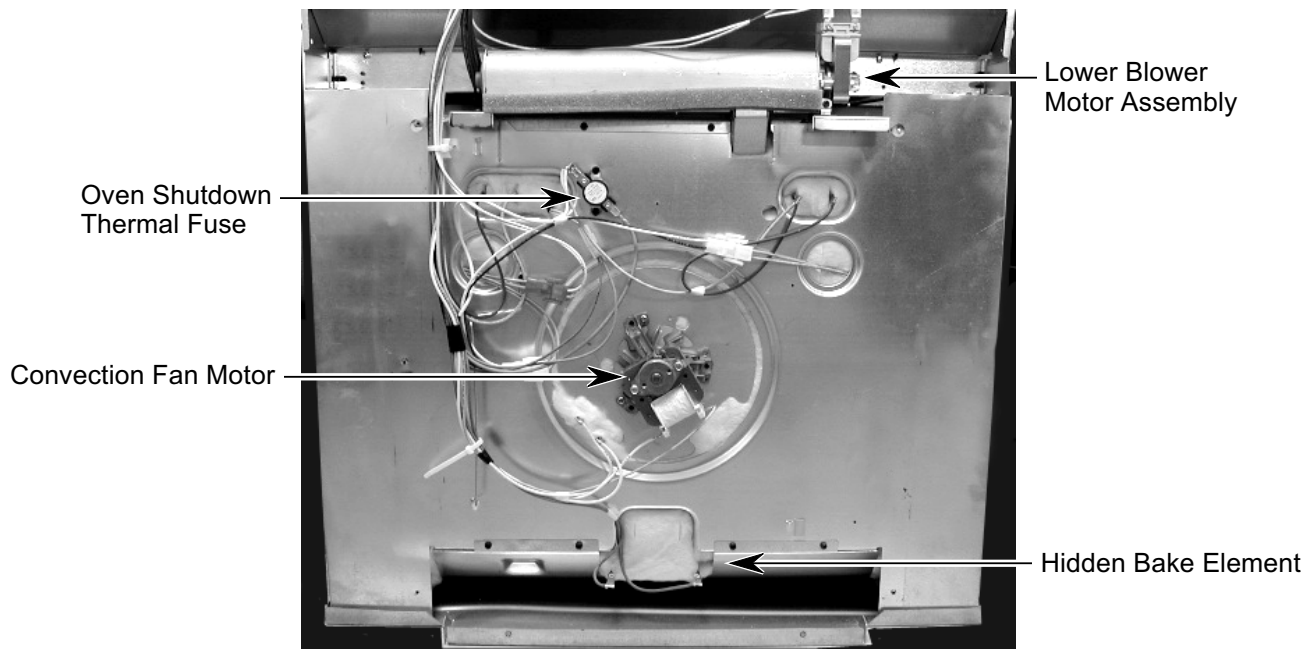

REMOVING THE LOWER OVEN DOOR LATCH ASSEMBLY

! WARNING

ELECTRICAL SHOCK HAZARD

Disconnect power before servicing.
Replace all panels before operating.
Failure to do so could result in death or electrical shock.

CAUTION: When you work on the microwave/oven combination, be careful when handling the sheet metal parts. Sharp edges may be present, and you can cut yourself if you are not careful.

1. Disconnect the electrical power to the microwave/oven combination.

The oven component described on this page is shown below.



2. Remove the racks from inside the oven.
3. Remove the four screws from the lower air vent and remove the air vent.

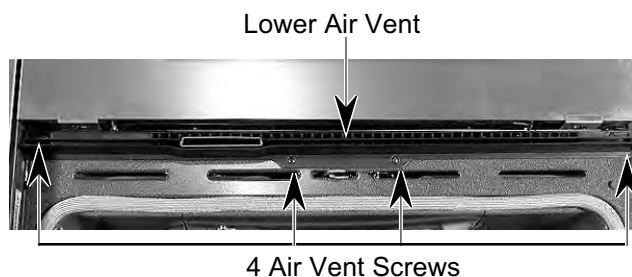

4. Use an angled screwdriver and remove the two screws from the lower oven door latch assembly.

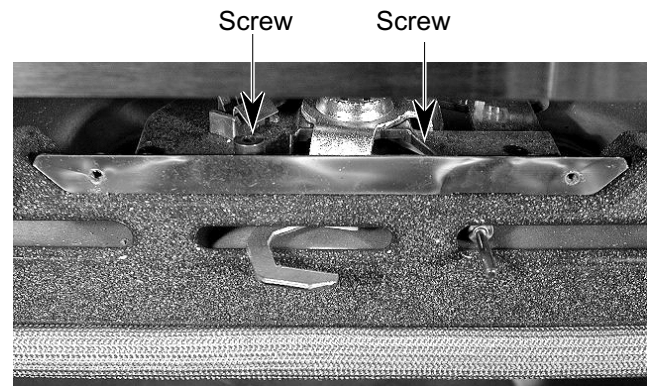

5. Remove the lower oven door latch assembly and disconnect the wires from the two switches and the solenoid terminals.

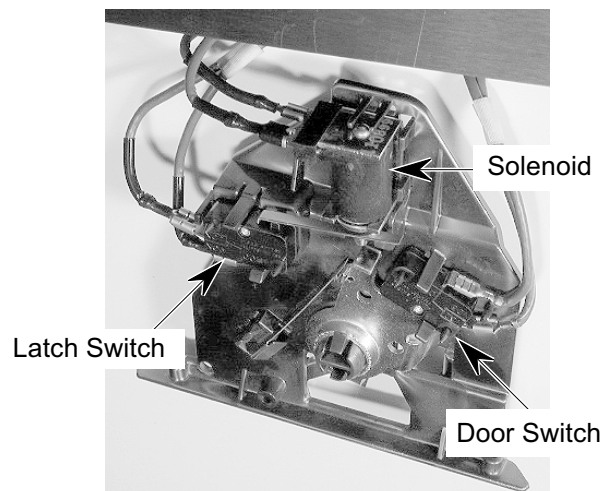

REMOVING THE BROIL ELEMENT

! WARNING

ELECTRICAL SHOCK HAZARD

Disconnect power before servicing.
Replace all panels before operating.
Failure to do so could result in death or electrical shock.

CAUTION: When you work on the microwave/oven combination, be careful when handling the sheet metal parts. Sharp edges may be present, and you can cut yourself if you are not careful.

1. Disconnect the electrical power to the microwave/oven combination.

The oven component described on this page is shown below.

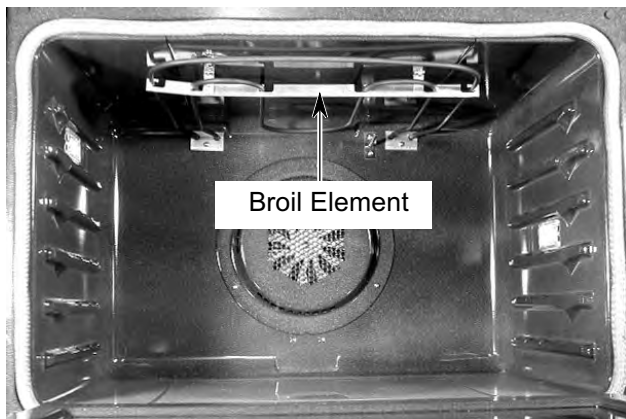

2. Remove the racks from inside the oven.

3. Remove the two front bracket screws and two rear bracket screws from the broil element.

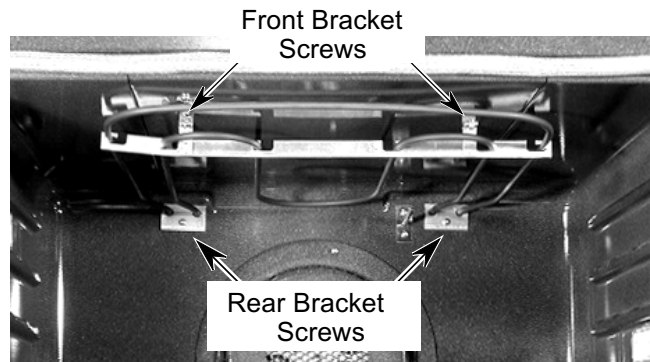

4. Carefully pull the element forward so that the terminal connectors are through the oven liner holes, and disconnect the wires from the terminals.

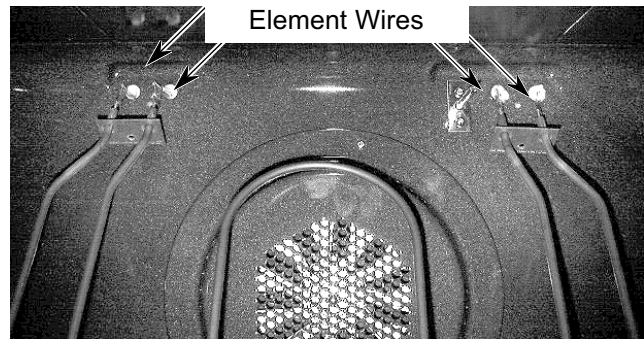

REMOVING THE OVEN TEMPERATURE SENSOR

WARNING

ELECTRICAL SHOCK HAZARD

Disconnect power before servicing.
Replace all panels before operating.
Failure to do so could result in death or electrical shock.

CAUTION: When you work on the microwave/oven combination, be careful when handling the sheet metal parts. Sharp edges may be present, and you can cut yourself if you are not careful.

The oven component described on this page is shown below.

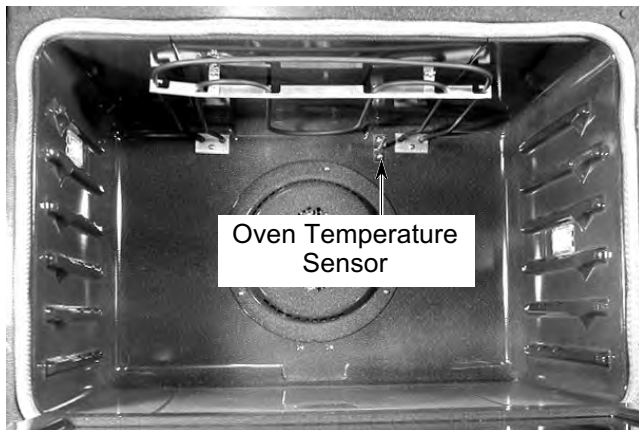

1. Disconnect the electrical power to the microwave/oven combination.
2. Remove the racks from inside the oven.
3. Remove the two mounting screws from the oven temperature sensor and pull the connectors out of the mounting hole in the oven liner.
4. Disconnect the sensor connector from the main wire harness connector.

Sensor Connector

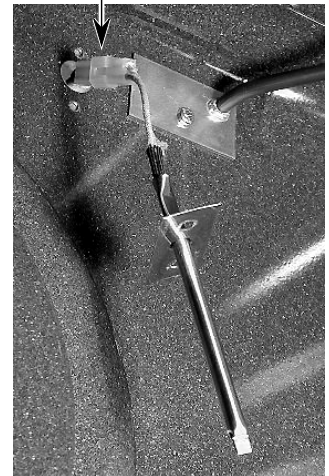

REMOVING A HALOGEN LAMP ASSEMBLY

! WARNING

ELECTRICAL SHOCK HAZARD

Disconnect power before servicing.
Replace all panels before operating.
Failure to do so could result in death or electrical shock.

CAUTION: When you work on the microwave/oven combination, be careful when handling the sheet metal parts. Sharp edges may be present, and you can cut yourself if you are not careful.

1. Disconnect the electrical power to the microwave/oven combination.

The oven component described on this page is shown below.

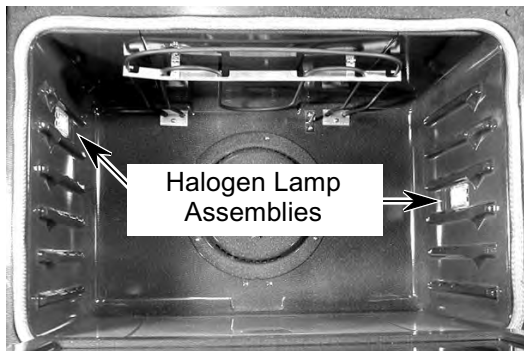

2. Remove the racks from inside the oven.
3. Remove the lens from the halogen lamp socket by lifting the end near the mounting screw and unsnapping it.
4. Remove the screw from the halogen lamp assembly.

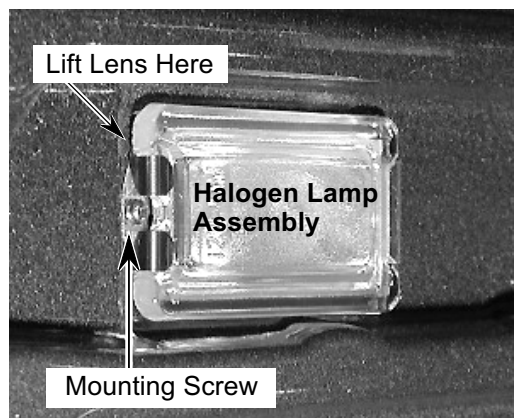

5. Pull the halogen bulb out of the socket.

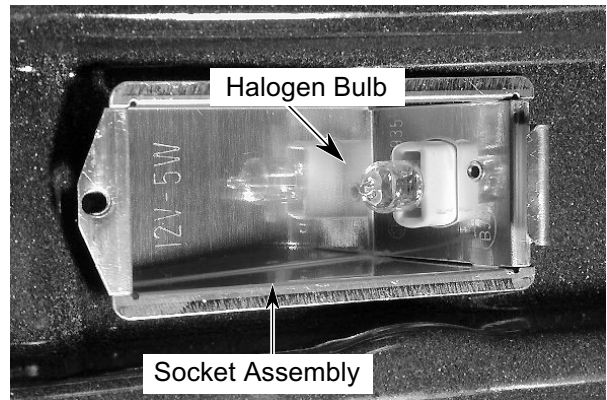

6. Pull the halogen socket assembly out of the oven liner and cut the wires near the socket terminals.



7. Cut the new halogen lamp socket wires to the proper length.
8. Remove 3/8" of insulation from the cut wires on the wire harness and the halogen lamp socket. Splice the halogen lamp socket wires to the harness wires, and twist two wire nuts over the bare wire ends.

REMOVING THE MEAT PROBE JACK

! WARNING

ELECTRICAL SHOCK HAZARD

Disconnect power before servicing.
Replace all panels before operating.
Failure to do so could result in death or electrical shock.

CAUTION: When you work on the microwave/oven combination, be careful when handling the sheet metal parts. Sharp edges may be present, and you can cut yourself if you are not careful.

1. Disconnect the electrical power to the microwave/oven combination.

The oven component described on this page is shown below.

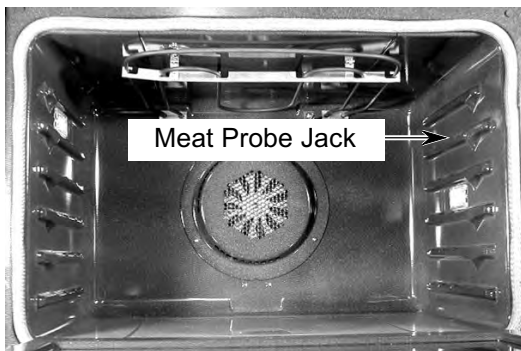

2. Remove the racks from inside the oven.
3. Remove the hex nut from the meat probe jack.

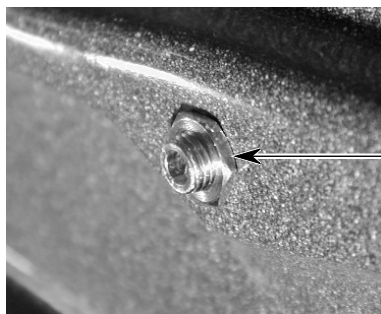

4. Pull the oven out of its mounting location approximately 8", (see page 2-6 steps 1 through 5 for the procedure), so that you can access the meat probe jack access panel on the right side.

5. Remove the meat probe jack access panel from the right side of the unit. Use a pair of small cutters to clip the bridge.

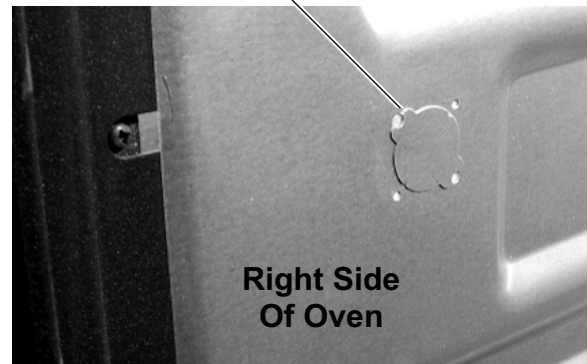
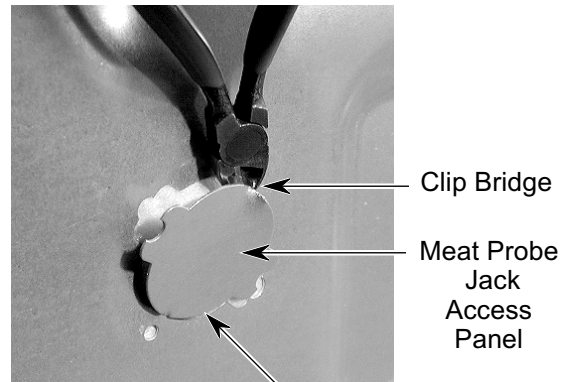

6. Push aside the insulation, pull the meat probe jack out of the access hole, and remove the star washer from the jack.
7. Cut the wires near the lugs of the old meat probe jack, then use two small wire nuts, and splice the new jack to the oven wires.

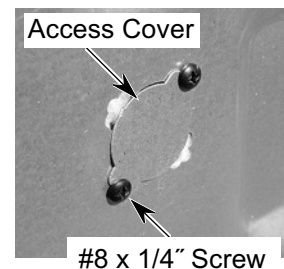
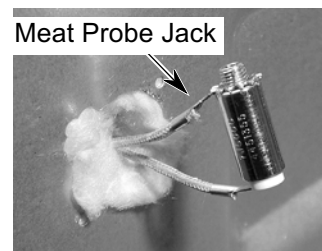

REASSEMBLY NOTE: When you install the new jack, be sure to place the star washer from the old jack on the threaded end of the new one. After you have installed the jack, mount the access cover with two #8 x 1/4" screws.

REMOVING THE REAR PANELS

! WARNING

ELECTRICAL SHOCK HAZARD

Disconnect power before servicing.
Replace all panels before operating.
Failure to do so could result in death or electrical shock.

CAUTION: When you work on the microwave/oven combination, be careful when handling the sheet metal parts. Sharp edges may be present, and you can cut yourself if you are not careful.

1. Disconnect the electrical power to the microwave/oven combination.
2. Pull the oven out of its mounting location, (see page 2-6 steps 1 through 5 for the procedure), so that you can access the rear panel.

3. To remove the bottom rear panel, remove the eleven screws.

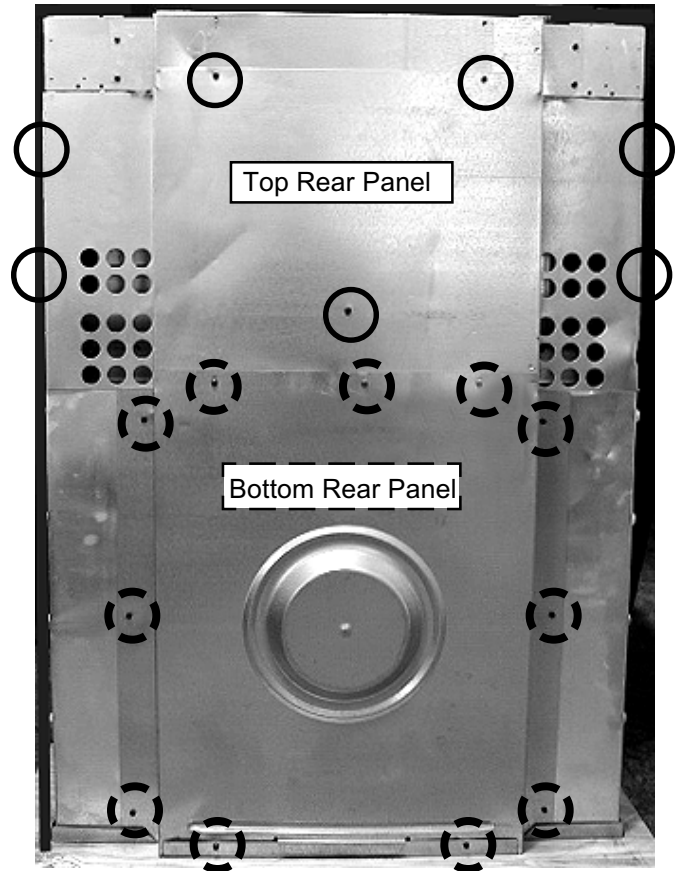

4. To remove the top rear panel, remove the remaining seven screws.

REMOVING THE CONVECTION BAKE ELEMENT & FAN MOTOR ASSEMBLY

! WARNING

ELECTRICAL SHOCK HAZARD

Disconnect power before servicing.
Replace all panels before operating.
Failure to do so could result in death or electrical shock.

CAUTION: When you work on the microwave/oven combination, be careful when handling the sheet metal parts. Sharp edges may be present, and you can cut yourself if you are not careful.

1. Disconnect the electrical power to the microwave/oven combination.
2. Remove the oven door from the oven (see page 2-42).

The oven components described on these pages are shown below.



3. Remove the racks from inside the oven.
4. Remove the three screws from the convection cover and remove the cover from the rear of the oven liner. Note the location of the notch in the cover. Be sure to

position the cover with the notch as shown when you reinstall it.

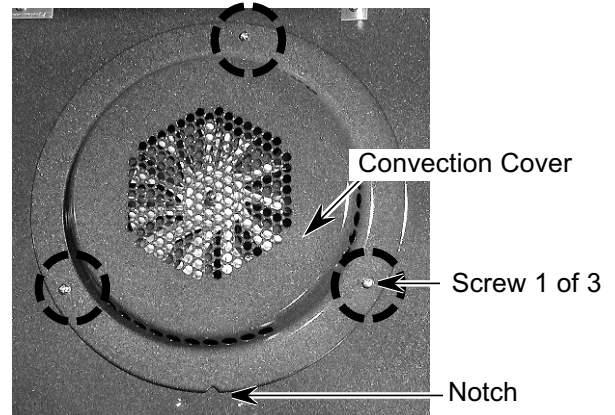

5. To remove the convection bake element:

- a) Remove the two screws from the convection bake element.
- b) Pull it forward so you can access the terminals.
- c) Disconnect the wires from the element terminals.

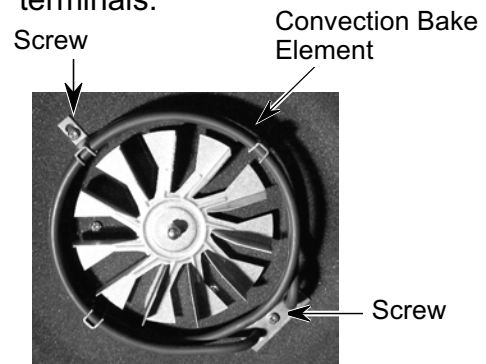

Element Terminals



Continued on the next page.

6. **To remove the convection fan motor:**

- a) If not already done, remove the convection cover and the convection bake element from the rear of the oven liner (see page 2-37).
- b) Use a 10 mm (7/16") socket and remove the hex nut from the convection fan. **NOTE:** The nut has a left-rotation thread for removal.

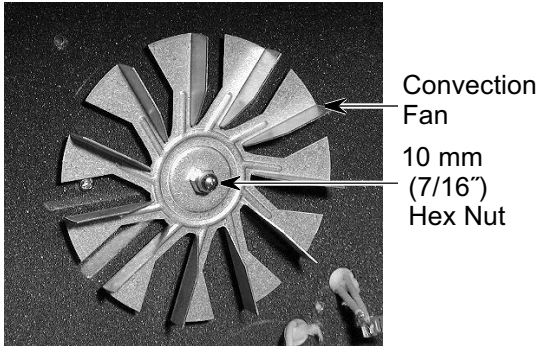

- c) Remove the three front convection fan motor screws from the rear of the oven liner.

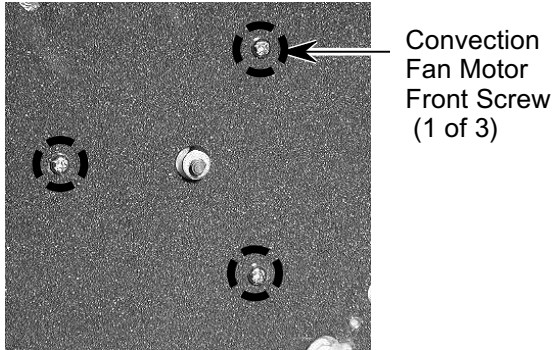

- d) Pull the oven out of its mounting location, (see page 2-6 steps 1 through 5 for the procedure), so that you can access the rear panels.
- e) Remove the bottom rear panel from the oven (see page 2-36).

- f) Remove the two rear convection fan motor mounting screws from the oven, and remove the motor from the rear of the oven.

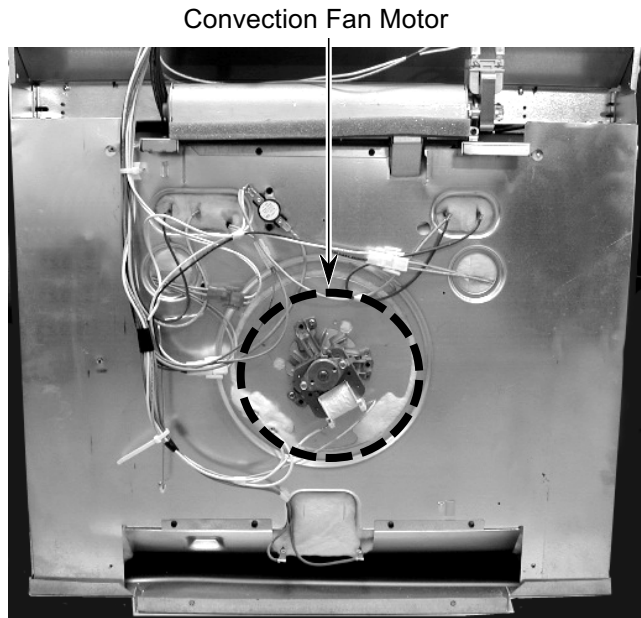

BACK OF OVEN

Convection Fan Motor Rear Screw (1 of 2)

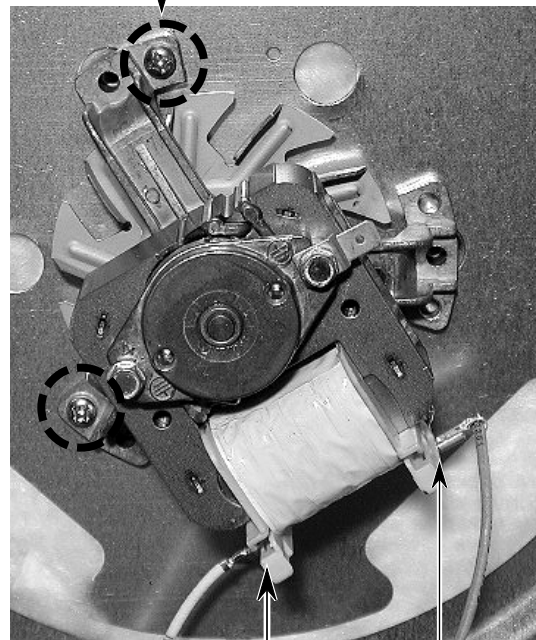

REMOVING THE LOWER BLOWER MOTOR ASSEMBLY

! WARNING

ELECTRICAL SHOCK HAZARD

Disconnect power before servicing.
Replace all panels before operating.
Failure to do so could result in death or electrical shock.

CAUTION: When you work on the microwave/oven combination, be careful when handling the sheet metal parts. Sharp edges may be present, and you can cut yourself if you are not careful.

1. Disconnect the electrical power to the microwave/oven combination.
2. Pull the oven out of its mounting location, (see page 2-6 steps 1 through 5 for the procedure), so that you can access the rear panels.
3. Remove the bottom rear panel from the oven (see page 2-36).

The oven component described on this page is shown below.

Lower Blower Motor Assembly

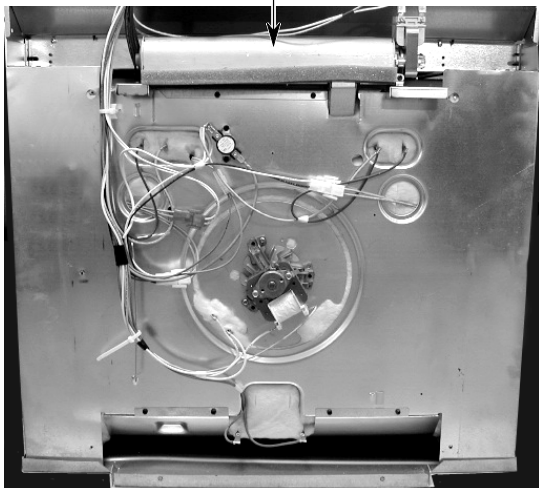

BACK OF OVEN

4. Remove the three mounting screws and the air vent screw from the blower motor assembly and remove the assembly from the oven.

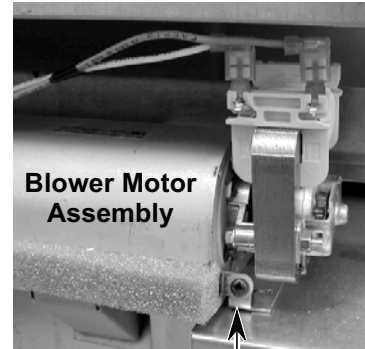

1 Right Screw



2 Left Screws

5. Peel the foam tape off the air duct screw, remove the screw from the duct, and remove the lower blower motor assembly.



Foam Tape Over
Air Duct Screw

Air Duct

REMOVING THE OVEN SHUTDOWN THERMAL FUSE & THE HIDDEN BAKE ELEMENT

⚠️ WARNING

ELECTRICAL SHOCK HAZARD

Disconnect power before servicing.
 Replace all panels before operating.
 Failure to do so could result in death or electrical shock.

CAUTION: When you work on the microwave/oven combination, be careful when handling the sheet metal parts. Sharp edges may be present, and you can cut yourself if you are not careful.

1. Disconnect the electrical power to the microwave/oven combination.
2. Pull the oven out of its mounting location, (see page 2-6 steps 1 through 5 for the procedure), so that you can access the rear panel.
3. Remove the bottom rear panel from the oven (see page 2-36).

The oven components described on these pages are shown below.

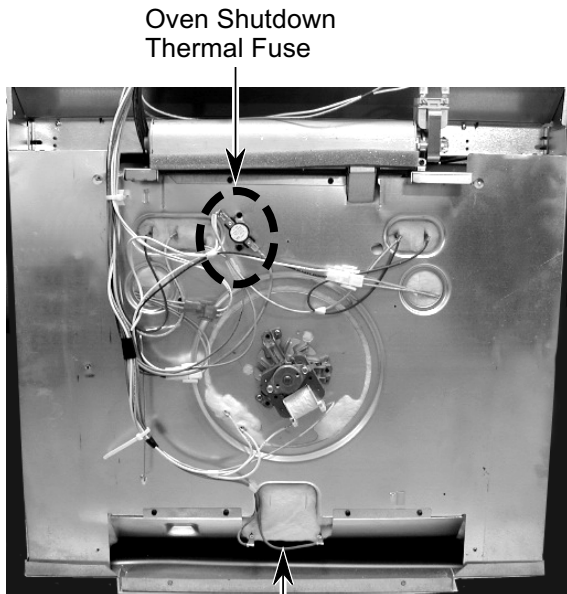

Hidden Bake Element
BACK OF OVEN

4. To remove the oven shutdown thermal fuse:

- a) Remove the two screws from the oven shutdown thermal fuse and remove the fuse from the rear of the oven.

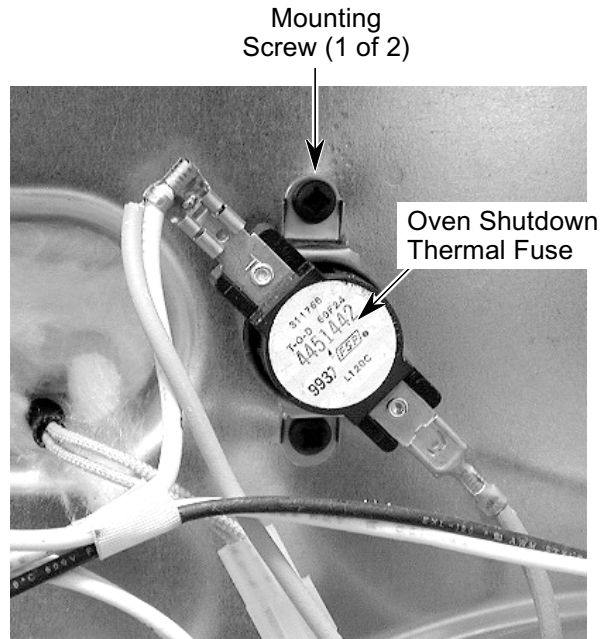

- b) Disconnect the wires from the thermal fuse terminals.

5. To remove the hidden bake element:

- a) Remove the four screws from the hidden bake element cover flanges.

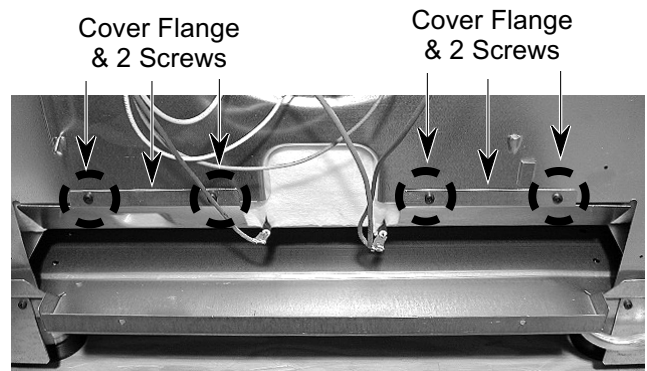

b) Bend the cover flanges down as far as they will go.

Bend Cover Flange Down

Bend Cover Flange Down

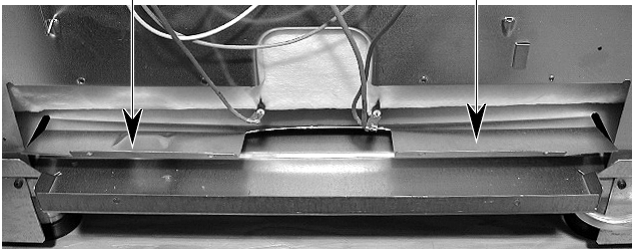

c) Use a pen knife or a single-edged razor blade and cut the insulation blanket, as shown. Be sure to separate the insulation blanket as cleanly as possible.

Cut Insulation Blanket

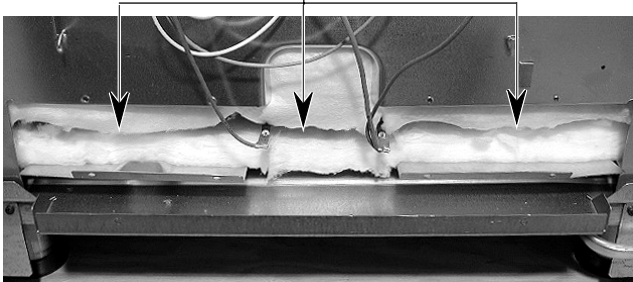

d) Carefully move the upper and lower sections of the insulation blanket out of the way so that you can access the hidden bake element and its mounting bracket.

e) Remove the four mounting bracket screws and the two hidden bake element bracket screws.

Remove Two Screws

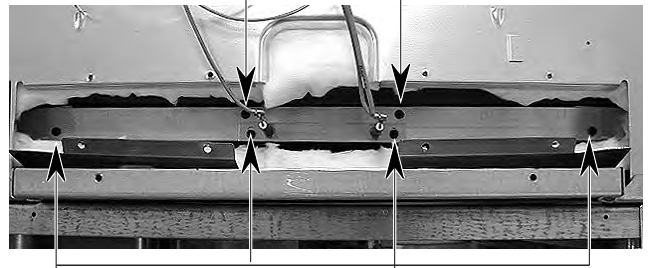

Remove Four Screws

f) Carefully pull the hidden bake element and its mounting bracket out of the oven.

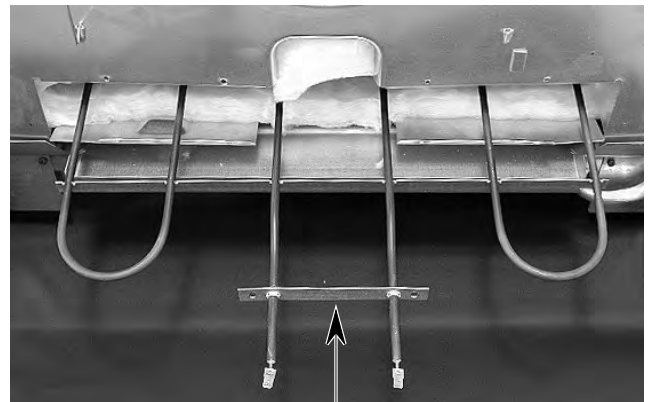

Pull Out Hidden Bake Element

REMOVING THE OVEN DOOR

CAUTION: When you work on the microwave/oven combination, be careful when handling the sheet metal parts. Sharp edges may be present, and you can cut yourself if you are not careful.

CAUTION: Do not lift the oven door by its handle.

To remove the oven door:

1. Install a pin in the hole of each oven door hinge hanger.

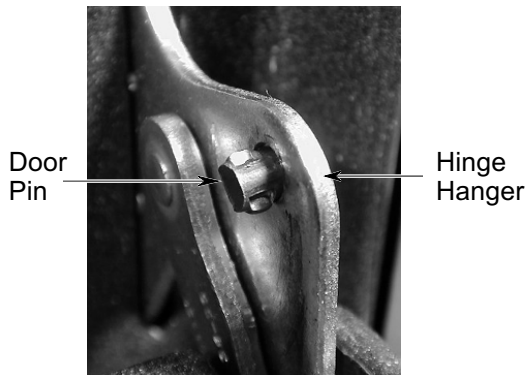

2. Close the oven door as far as the two pins will allow.
3. Grasp the sides of the door and lift the door until it stops, then pull the hinge hangers out of the slots.



To reinstall the oven door:

1. Grasp the sides of the door and tilt it back at a slight angle, then insert the hinge hangers into the hinge slots as far as they will go.
2. Rotate the top of the door towards the oven so the hinge hangers fit onto the support pins.
3. Close the oven door as far as the pins will allow, and make sure that the hinge hangers are fully seated on the support pins. If they are not seated properly, the door will not close tightly and may be off-center. To seat the hinge hangers, open the door slightly, and push in on the bottom until the hangers are fully seated.
4. Open the oven door to its fully open position and remove the two hinge hanger pins.
5. Close the oven door completely and check it for proper operation and alignment.

REMOVING THE OVEN DOOR GLASS, HINGES, & HANDLE

CAUTION: When you work on the microwave/oven combination, be careful when handling the sheet metal parts. Sharp edges may be present, and you can cut yourself if you are not careful.

1. Remove the oven door from the oven (see page 2-42).
2. Place the oven door on a padded work surface with the front decorative glass facing down.
3. Remove the two top door liner screws and the two door glass bracket screws, and lift the liner assembly off the decorative door glass and handle.



4. **To remove the outer door glass:**
 - a) Remove the three outer glass holder screws and two outer glass bracket screws from the door liner.
 - b) Lift the outer glass with the glass holder off the door liner.
 - c) Remove the bracket.

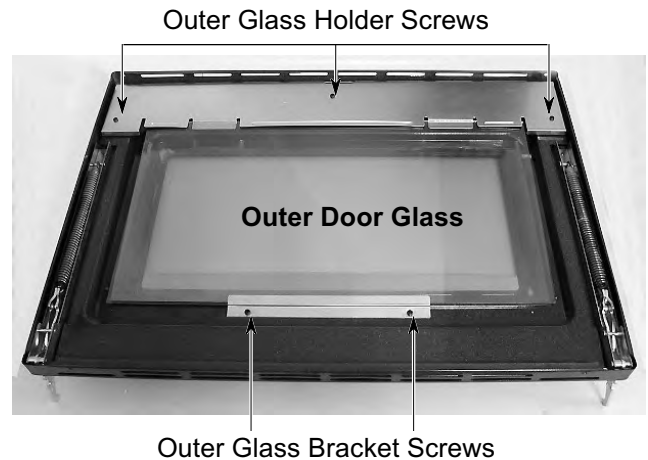

5. **To remove the center door glass,** remove the bottom bracket, (it is loose), and slide the two top corners of the glass out of the door liner slots.

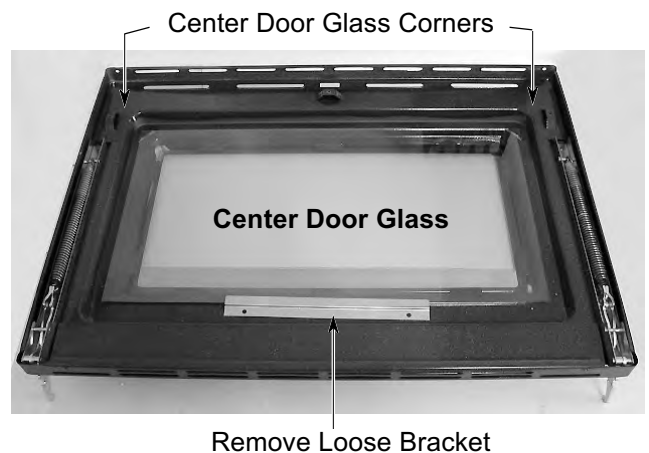

Continued on the next page.

6. **To remove the hinges and the inner door glass:**

NOTE: You will have to remove both hinges to remove the inner door glass from the oven door liner.

- a) Lift either side of the door liner, remove the two door hinge screws, and remove the hinge.



- b) Lift the other side of the door liner, remove the two screws for the other hinge, and remove the hinge.
- c) Lift the inner door glass liner cover off the liner.

- d) Remove the insulation and the inner door glass.

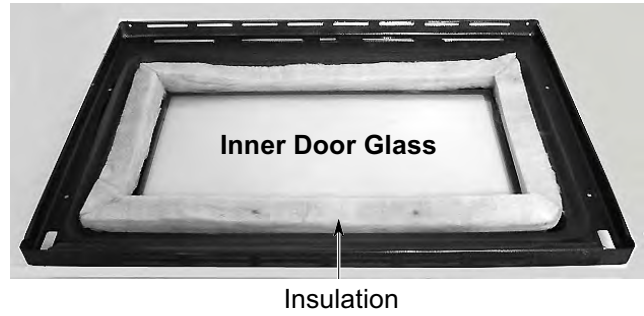

7. **To remove the door handle,** remove the two door handle screws from the bracket.

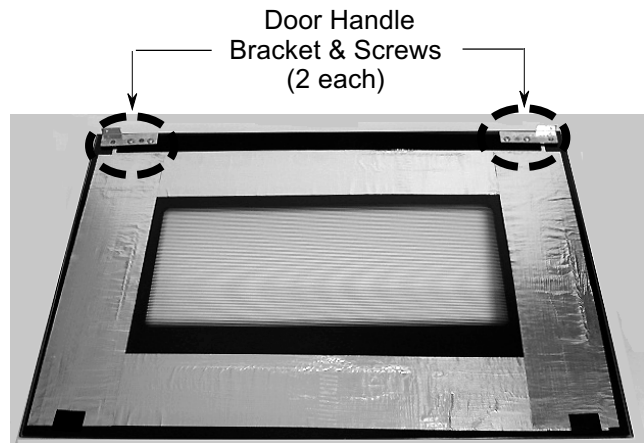

REMOVING THE OVEN DOOR GASKET

CAUTION: When you work on the microwave/oven combination, be careful when handling the sheet metal parts. Sharp edges may be present, and you can cut yourself if you are not careful.

1. Open the oven door to its fully open position.
2. Remove the screw from the door gasket bracket and remove the bracket from the oven.

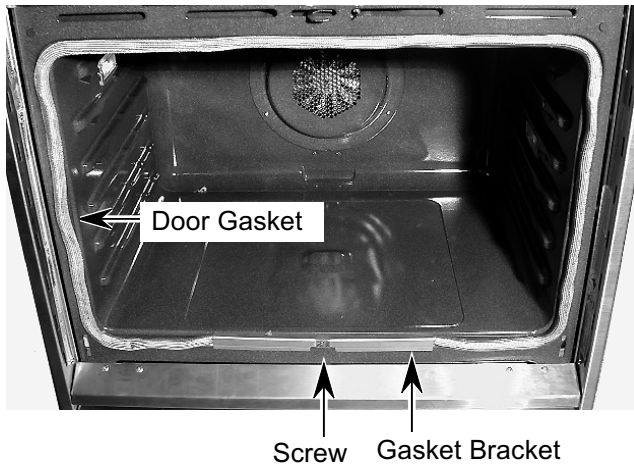

3. Pull the ends of the gasket out of the liner holes.

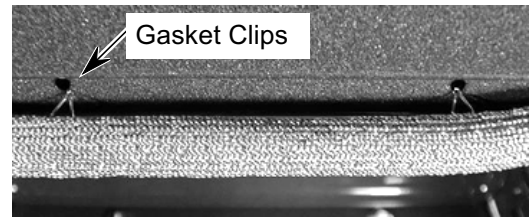

REASSEMBLY NOTE: When you install the new gasket, make sure that all of the clips are seated in their liner holes, and that the ends of the gasket are pushed fully into their holes. Use the pointed end of a pencil to push the gasket ends into the holes.

— NOTES —

COMPONENT TESTING

Before testing any of the components, perform the following checks:

- The most common cause for control failure is corrosion on connectors. Therefore, disconnecting and reconnecting wires will be necessary throughout test procedures.
- All tests/checks should be made with a VOM or DVM having a sensitivity of 20,000 ohms-per-volt DC, or greater.
- Check all connections before replacing components, looking for broken or loose wires, failed terminals, or wires not pressed into connectors far enough.
- Voltage checks must be made with all connectors attached to the boards.
- Resistance checks must be made with power cord unplugged from outlet, and with wiring harness or connectors disconnected.

THE GENERAL OVEN COMPONENTS

! WARNING

ELECTRICAL SHOCK HAZARD

Disconnect power before servicing.
Replace all panels before operating.
Failure to do so could result in death or electrical shock.

LOW VOLTAGE TRANSFORMER

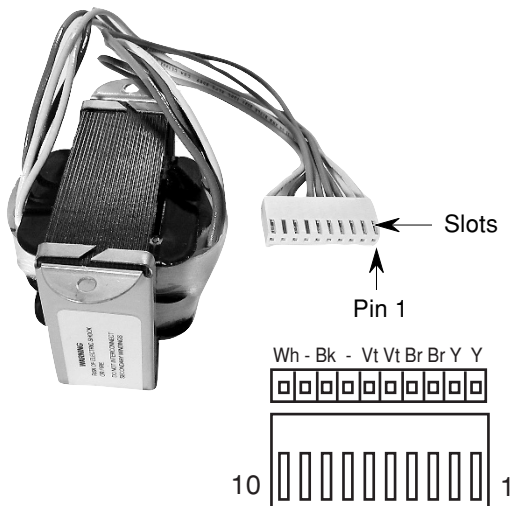

Refer to page 2-4 for the procedure for servicing the low voltage transformer.

1. Disconnect the electrical power to the microwave/oven combination.
2. Disconnect the low voltage transformer connector from the oven control board.
3. Set the ohmmeter to the R x 1 scale.
4. Touch the ohmmeter leads to the indicated slots of the low voltage transformer connector. The meter should indicate as follows:

1st Secondary—Pins 1 & 2 = Less than 1 Ω .
2nd Secondary—Pins 3 & 4 = Less than 1 Ω .
3rd Secondary—Pins 5 & 6 = Less than 1 Ω .
Primary—Pins 8 & 10 = Approximately 5 Ω .

! WARNING

ELECTRICAL SHOCK HAZARD

Disconnect power before servicing.
Replace all panels before operating.
Failure to do so could result in death or electrical shock.

MAIN LINE FUSE



Refer to page 2-4 for the procedure for servicing the main line fuse.

1. Disconnect the electrical power to the microwave/oven combination.
2. Disconnect the wires from the line fuse terminals.
3. Set the ohmmeter to the R x 1 scale.
4. Unclip the fuse from the fuseholder.
5. Touch the ohmmeter leads to the ends of the fuse. The meter should indicate continuity if the fuse is good. If the fuse is open, the meter will indicate infinity.

! WARNING

ELECTRICAL SHOCK HAZARD

Disconnect power before servicing.
Replace all panels before operating.
Failure to do so could result in death or electrical shock.

LIGHT POWER SUPPLIES

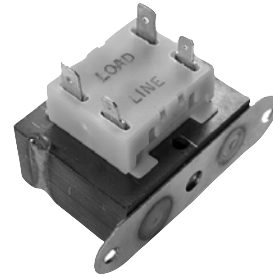

Refer to page 2-4 for the procedure for servicing the light power supplies.

NOTE: The measurements are the same for both light power supplies.

1. Disconnect the electrical power to the microwave/oven combination.
2. Disconnect one of the wires from each of the light power supply LOAD and LINE terminals.
3. Set the ohmmeter to the R x 1 scale.
4. Touch the ohmmeter leads to the LOAD terminals. The meter should indicate less than 1 Ω .
5. Touch the ohmmeter leads to the LINE terminals. The meter should indicate between 40 and 45 Ω .

THE MICROWAVE OVEN COMPONENTS

! WARNING

ELECTRICAL SHOCK HAZARD

Disconnect power before servicing.
Replace all panels before operating.
Failure to do so could result in death or electrical shock.

TURNTABLE MOTOR

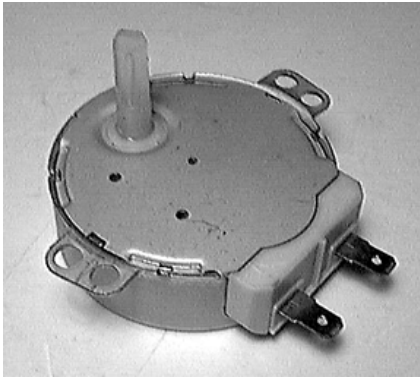

Refer to page 2-26 for the procedure for servicing the turntable motor.

1. Disconnect the electrical power to the microwave/oven combination.
2. Disconnect the wires from the turntable motor terminals.
3. Set the ohmmeter to the R x 1 scale.
4. Touch the ohmmeter leads to the motor terminals. The meter should indicate approximately 25 Ω .

! WARNING

ELECTRICAL SHOCK HAZARD

Disconnect power before servicing.
Replace all panels before operating.
Failure to do so could result in death or electrical shock.

COOLING FAN MOTOR

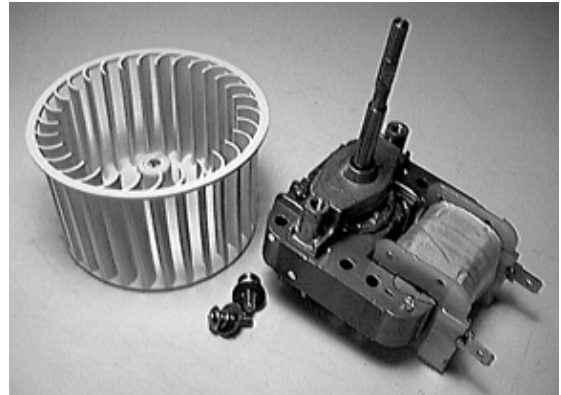

Refer to page 2-18 for the procedure for servicing the cooling fan motor.

1. Disconnect the electrical power to the microwave/oven combination.
2. Disconnect the wires from the cooling fan motor terminals.
3. Set the ohmmeter to the R x 1 scale.
4. Touch the ohmmeter leads to the motor terminals. The meter should indicate approximately 25 Ω .

! WARNING

ELECTRICAL SHOCK HAZARD

Disconnect power before servicing.
Replace all panels before operating.
Failure to do so could result in death or electrical shock.

UPPER BLOWER MOTOR

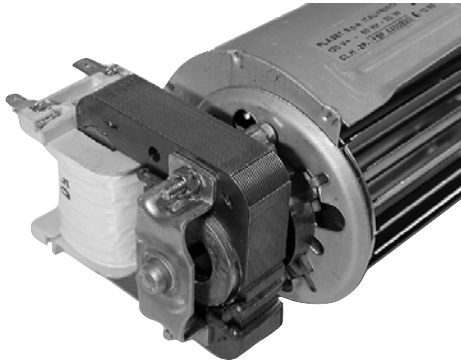

Refer to page 2-6 for the procedure for servicing the upper blower motor.

1. Disconnect the electrical power to the microwave/oven combination.
2. Disconnect the wires from the blower motor terminals.
3. Set the ohmmeter to the R x 1 scale.
4. Touch the ohmmeter leads to the motor terminals. The meter should indicate between 10 and 15 Ω .

! WARNING

ELECTRICAL SHOCK HAZARD

Disconnect power before servicing.
Replace all panels before operating.
Failure to do so could result in death or electrical shock.

CONVECTION FAN MOTOR



Refer to page 2-16 for the procedure for servicing the convection fan motor.

1. Disconnect the electrical power to the microwave/oven combination.
2. Disconnect the wires from the convection fan motor terminals.
3. Set the ohmmeter to the R x 1 scale.
4. Touch the ohmmeter leads to the motor terminals. The meter should indicate between 15 and 21 Ω .

! WARNING

ELECTRICAL SHOCK HAZARD

Disconnect power before servicing.
Replace all panels before operating.
Failure to do so could result in death or electrical shock.

CONVECTION TEMPERATURE SENSOR



Refer to page 2-14 for the procedure for servicing the convection temperature sensor.

1. Disconnect the electrical power to the microwave/oven combination.
2. Disconnect the convection temperature sensor connector from the oven control board.
3. Set the ohmmeter to the R x 1K scale.
4. Touch the ohmmeter leads to the sensor connector pins. The meter should indicate as shown in the chart below:

Convection Temperature Sensor Chart

Room Ambient:	15°C (59°F)	20°C (68°F)	25°C (77°F)	30°C (86°F)
Resistance (KΩ):	294.7-471.2	233.2-366.9	185.7-287.7	148.8-227.2

! WARNING

ELECTRICAL SHOCK HAZARD

Disconnect power before servicing.
Replace all panels before operating.
Failure to do so could result in death or electrical shock.

CAVITY, GRILL, CONVECTION, & MAGNETRON THERMAL FUSES

Cavity



Grill & Convection



Magnetron



Refer to the cavity thermal fuse (page 2-14), the grill thermal fuse (page 2-12), the convection thermal fuse (page 2-16), and the magnetron thermal fuse (page 2-20) for the servicing procedures.

1. Disconnect the electrical power to the microwave/oven combination.
2. Disconnect the wires from the terminals of the thermal fuse under test.
3. Set the ohmmeter to the R x 1 scale.
4. Touch the ohmmeter leads to the thermal fuse terminals. The meter should indicate as follows:

Cavity:	Opens @ 165°C (329°F) Non-Resettable
Grill:	Opens @ 175°C (347°F) Closes @ 125°C (257°F)
Convection:	Opens @ 145°C (293°F) Closes @ 105°C (221°F)
Magnetron:	Opens @ 145°C (293°F) Closes @ 125°C (257°F)

⚠️ WARNING

ELECTRICAL SHOCK HAZARD

Disconnect power before servicing.
Replace all panels before operating.
Failure to do so could result in death or electrical shock.

CONVECTION ELEMENT

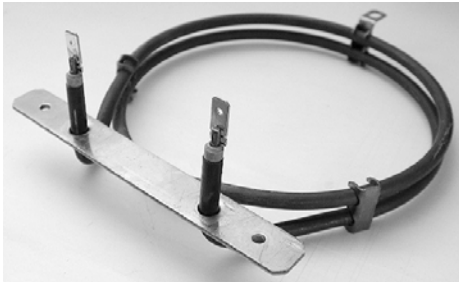

Refer to page 2-16 for the procedure for servicing the convection element.

1. Disconnect the electrical power to the microwave/oven combination.
2. Disconnect the wires from the convection element terminals.
3. Set the ohmmeter to the R x 1 scale.
4. Touch the ohmmeter leads to the element terminals. The meter should indicate between 10 and 20 Ω .

⚠️ WARNING

ELECTRICAL SHOCK HAZARD

Disconnect power before servicing.
Replace all panels before operating.
Failure to do so could result in death or electrical shock.

GRILL ELEMENT ASSEMBLY

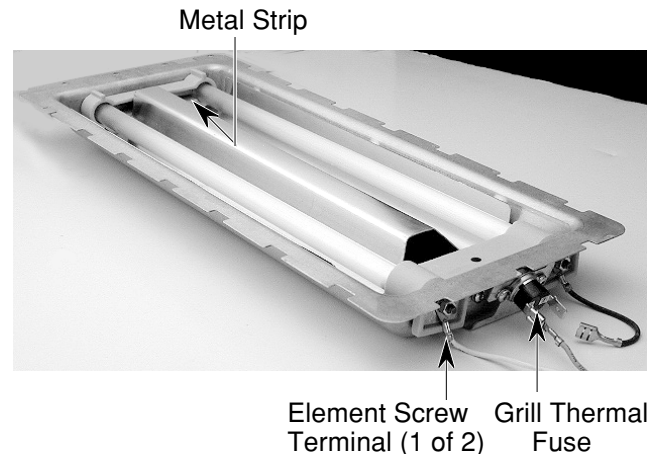

Refer to page 2-12 for the procedure for servicing the grill element assembly.

1. Disconnect the electrical power to the microwave/oven combination.
2. Disconnect the black element wire from the grill thermal fuse terminal.
3. Set the ohmmeter to the R x 1 scale.
4. Touch one of the ohmmeter leads to the metal strip between the ends of the elements. Touch the other lead to one of the element screw terminals, and then the other element screw terminal. The meter should indicate approximately 7 Ω at each element screw terminal.
5. Touch the ohmmeter leads to each of the element screw terminals. The meters should indicate between 11 and 17 Ω .

! WARNING

ELECTRICAL SHOCK HAZARD

Disconnect power before servicing.
Replace all panels before operating.
Failure to do so could result in death or electrical shock.

LINE FUSE, HIGH VOLTAGE RECTIFIER & CAPACITOR

Refer to page 2-24 for the procedure for servicing the line fuse, the high voltage rectifier (diode), and the high voltage capacitor.

1. Disconnect the electrical power to the microwave/oven combination.

Microwave Oven Line Fuse W/Fuseholder

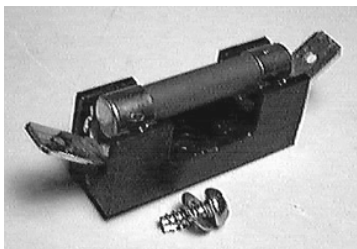

2. **To test the line fuse:**

- a) Unclip the fuse from the fuseholder.
- b) Set the ohmmeter to the R x 1 scale.
- c) Touch the ohmmeter leads to the ends of the fuse. The meter should indicate continuity if the fuse is good. If the fuse is open, the meter will indicate infinity.

High Voltage Rectifier (Diode)

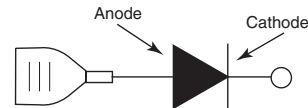
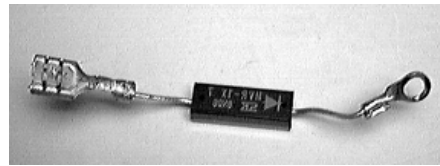

3. **To test the high voltage rectifier:**
 - a) Disconnect the diode lead from the high voltage capacitor.
 - b) Set the ohmmeter to the R x 1K scale.
 - c) Touch the positive ohmmeter lead to the anode lead of the diode and the negative lead to the cathode. The meter should indicate continuity.
 - d) Reverse the ohmmeter leads on the diode and the meter should indicate infinity.

High Voltage Capacitor



4. **To test the high voltage capacitor:**
 - a) Disconnect the diode and wires from the high voltage capacitor terminals.
 - b) Set the ohmmeter to the R x 1K scale.
 - c) Touch the ohmmeter leads to the capacitor terminals. The meter should indicate several ohms, and gradually return to infinity.
 - d) Touch one of the ohmmeter leads to the chassis and the other to the capacitor terminals. The meter should indicate infinity.

! WARNING

ELECTRICAL SHOCK HAZARD

Disconnect power before servicing.
Replace all panels before operating.
Failure to do so could result in death or electrical shock.

AIR VENT SOLENOID

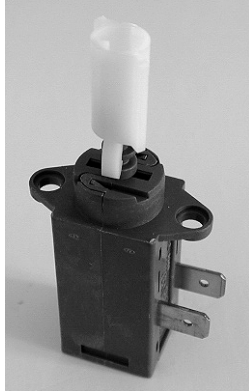

Refer to page 2-18 for the procedure for servicing the air vent solenoid.

1. Disconnect the electrical power to the microwave/oven combination.
2. Disconnect the wire from one of the solenoid terminals.
3. Set the ohmmeter to the R x 1K scale.
4. Touch the ohmmeter leads to the terminals. The meter should indicate approximately 1650 Ω .

! WARNING

ELECTRICAL SHOCK HAZARD

Disconnect power before servicing.
Replace all panels before operating.
Failure to do so could result in death or electrical shock.

INTERLOCK SWITCHES



Refer to page 2-10 for the procedure for servicing the interlock switches.

1. Disconnect the electrical power to the microwave/oven combination.
2. Disconnect the wires from the interlock switch under test.
3. Set the ohmmeter to the R x 1 scale.
4. Touch the ohmmeter leads to the following terminals (shown embossed on the switch). The meter should indicate:
COM to N.O. = infinity (no continuity)
COM to N.C. = 0 Ω (continuity)
5. Press the switch actuator button, and touch the ohmmeter leads to the following terminals. The meter should indicate:
COM to N.O. = 0 Ω (continuity)
COM to N.C. = infinity (no continuity)

! WARNING

ELECTRICAL SHOCK HAZARD

Disconnect power before servicing.
Replace all panels before operating.
Failure to do so could result in death or electrical shock.

HIGH VOLTAGE TRANSFORMER

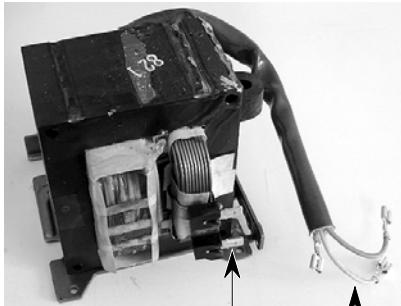

Primary Terminals 3 Secondary Wires

Refer to page 2-22 for the procedure for servicing the high voltage transformer.

1. Disconnect the electrical power to the microwave/oven combination.
2. Disconnect the three high voltage transformer secondary wires from the high voltage capacitor and magnetron.
3. Disconnect the two wires from the primary terminals.
4. Set the ohmmeter to the R x 1 scale.
5. Touch the ohmmeter leads to the two primary terminals. The meter should indicate less than 1 Ω .
6. Touch the ohmmeter leads to the two orange/red (filament) wires. The meter should indicate less than 1 Ω .
7. Touch one ohmmeter lead to the light yellow secondary wire, and the other lead to the chassis. The meter should indicate 0 Ω .
8. Touch one ohmmeter lead to the primary and filament terminals, and the other lead to the chassis. The meter should indicate infinity.

! WARNING

ELECTRICAL SHOCK HAZARD

Disconnect power before servicing.
Replace all panels before operating.
Failure to do so could result in death or electrical shock.

MAGNETRON

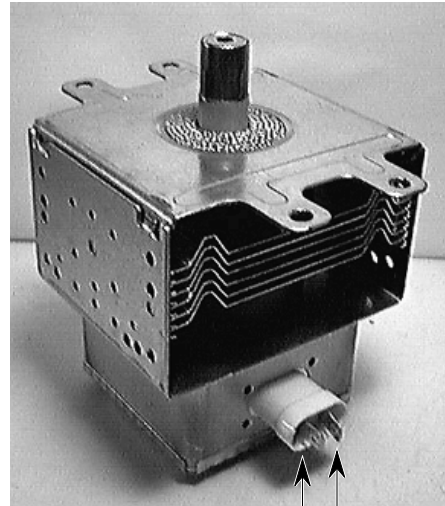

Filament Terminals

Refer to page 2-20 for the procedure for servicing the magnetron.

1. Disconnect the electrical power to the microwave/oven combination.
2. Disconnect the wires from the filament terminals.
3. Set the ohmmeter to the R x 1 scale.
4. Touch the ohmmeter leads to the filament terminals. The meter should indicate approximately 0 Ω .
5. Set the ohmmeter to the R x 1K scale.
6. Touch one ohmmeter lead to the filament terminals, and the other lead to the chassis. The meter should indicate infinity.

THE LOWER OVEN COMPONENTS

! WARNING

ELECTRICAL SHOCK HAZARD

Disconnect power before servicing.
Replace all panels before operating.
Failure to do so could result in death or electrical shock.

OVEN DOOR LATCH ASSEMBLY

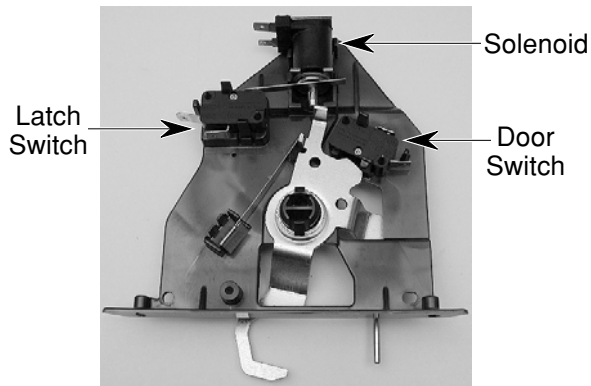

Refer to page 2-31 for the procedure for servicing the oven door latch assembly.

1. Disconnect the electrical power to the microwave/oven combination.
2. Disconnect the wires from the door latch assembly component under test.
3. Set the ohmmeter to the R x 1 scale.
4. **To test the solenoid**, touch the ohmmeter leads to the terminals. The meter should indicate between 47 and 54 Ω .
5. **To test the door or latch switch:**
 - a) Touch the ohmmeter leads to the following terminals (shown embossed on the switch). The meter should indicate:
COM to N.O. = infinity (no continuity)
COM to N.C. = 0 Ω (continuity)
 - b) Press the switch actuator button and touch the ohmmeter leads to the following terminals. The meter should indicate:
COM to N.O. = 0 Ω (continuity)
COM to N.C. = infinity (no continuity)

! WARNING

ELECTRICAL SHOCK HAZARD

Disconnect power before servicing.
Replace all panels before operating.
Failure to do so could result in death or electrical shock.

LOWER BLOWER MOTOR

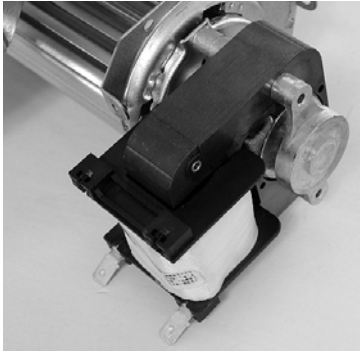

Refer to page 2-39 for the procedure for servicing the lower blower motor.

1. Disconnect the electrical power to the microwave/oven combination.
2. Disconnect the wires from the blower motor terminals.
3. Set the ohmmeter to the R x 1 scale.
4. Touch the ohmmeter leads to the blower motor terminals. The meter should indicate between 14 and 18 Ω .

! WARNING

ELECTRICAL SHOCK HAZARD

Disconnect power before servicing.
Replace all panels before operating.
Failure to do so could result in death or electrical shock.

OVEN TEMPERATURE SENSOR



Refer to page 2-33 for the procedure for servicing the oven temperature sensor.

1. Disconnect the electrical power to the microwave/oven combination.
2. Disconnect the oven temperature sensor connector from the oven connector.
3. Set the ohmmeter to the R x 1K scale.
4. Touch the ohmmeter leads to the sensor connector pins. The meter should indicate 1080 Ω @ 70°F.

! WARNING

ELECTRICAL SHOCK HAZARD

Disconnect power before servicing.
Replace all panels before operating.
Failure to do so could result in death or electrical shock.

CONVECTION BAKE ELEMENT

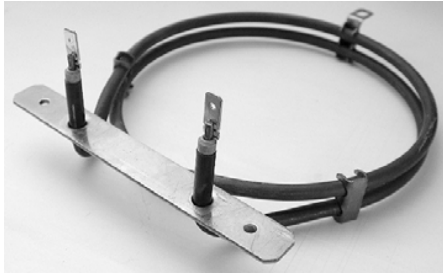

Refer to page 2-37 for the procedure for servicing the convection bake element.

1. Disconnect the electrical power to the microwave/oven combination.
2. Disconnect the wires from the convection bake element terminals.
3. Set the ohmmeter to the R x 1 scale.
4. Touch the ohmmeter leads to the element terminals. The meter should indicate between 33 and 37 Ω .

! WARNING

ELECTRICAL SHOCK HAZARD

Disconnect power before servicing.
Replace all panels before operating.
Failure to do so could result in death or electrical shock.

CONVECTION FAN MOTOR

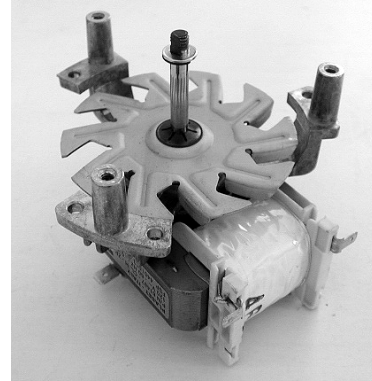

Refer to page 2-37 for the procedure for servicing the convection fan motor.

1. Disconnect the electrical power to the microwave/oven combination.
2. Disconnect the wires from the convection fan motor terminals.
3. Set the ohmmeter to the R x 1 scale.
4. Touch the ohmmeter leads to the motor terminals. The meter should indicate between 14 and 21 Ω .

! WARNING

ELECTRICAL SHOCK HAZARD

Disconnect power before servicing.
Replace all panels before operating.
Failure to do so could result in death or electrical shock.

BROIL ELEMENT

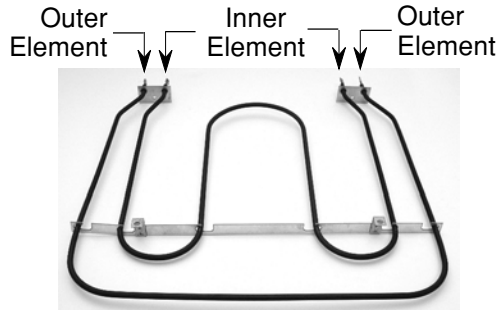

Refer to page 2-32 for the procedure for servicing the broil element.

1. Disconnect the electrical power to the microwave/oven combination.
2. Disconnect the wires from the broil element terminals.
3. Set the ohmmeter to the R x 1 scale.
4. Touch the ohmmeter leads to the **inner** broil element terminals. The meter should indicate between 32 and 35 Ω .
5. Touch the ohmmeter leads to the **outer** broil element terminals. The meter should indicate between 53 and 59 Ω .

! WARNING

ELECTRICAL SHOCK HAZARD

Disconnect power before servicing.
Replace all panels before operating.
Failure to do so could result in death or electrical shock.

HIDDEN BAKE ELEMENT



Refer to page 2-40 for the procedure for servicing the hidden bake element.

1. Disconnect the electrical power to the microwave/oven combination.
2. Disconnect the wires from the bake element terminals.
3. Set the ohmmeter to the R x 1 scale.
4. Touch the ohmmeter leads to the element terminals. The meter should indicate between 25 and 30 Ω .

! WARNING

ELECTRICAL SHOCK HAZARD

Disconnect power before servicing.
Replace all panels before operating.
Failure to do so could result in death or electrical shock.

OVEN SHUTDOWN THERMAL FUSE



Refer to page 2-40 for the procedure for servicing the oven shutdown thermal fuse.

1. Disconnect the electrical power to the microwave/oven combination.
2. Disconnect the wires from the oven shutdown thermal fuse terminals.
3. Set the ohmmeter to the R x 1 scale.
4. Touch the ohmmeter leads to the oven shutdown thermal fuse terminals. The meter should indicate continuity (closed circuit).

— NOTES —

DIAGNOSIS & TROUBLESHOOTING

FAILURE / ERROR DISPLAY CODES

- Always disconnect power before touching any internal parts in the oven.
- Upon replacement, immediately return the old electronic oven control using the mailing label that is supplied with each new control.
- For combo ovens, the failure code is displayed on the side of the display that corresponds to the oven with the faulty part (upper oven = left side of display).

FAULT CODE	ERROR CODE	CODE EXPLANATION	RECOMMENDED REPAIR PROCEDURE
F0	E0	Default F code — no failure	Will only be displayed if user presses and holds CANCEL key for 5 seconds and there is no pre-existing fault. Press CANCEL again to clear display.
F1	All E Codes	Electronic control malfunction	Replace the electronic control if the E code is not E3.
F2	E0	Keypad not connected	1. Check keypad connector for firm connection.
	E3	Key held down too long, or key is shorted	2. Press CANCEL. If error code returns after 60 seconds, replace keypad.
F3	E0	Temperature sensor opened	1. Check sensor connection.
	E1	Temperature sensor shorted	2. Measure sensor resistance (1080 Ω @ 70°F. Add 2 Ω per degree).
	All Other E Codes	Oven temperature too high	3. If resistance is not valid, replace sensor. 4. If sensor resistance and connections are good, then the oven cavity temperature must have exceeded a safe level. Check for welded-closed relays on the control.
F5	E1	Self-clean latch will not lock/unlock	1. Check the latch assembly arm/pivot joint and arm solenoid connection, solenoid spring, and spring washer.
	E0	Door is open but latch is locked	2. Check the latch solenoid: - Check for firm electrical connections. - Disconnect the two wires from the solenoid and measure the resistance at the terminals. A resistance of approximately 300 Ω is normal. Replace the solenoid if it is shorted (0 Ω) or open (infinity).
	F2	Door latch error during Self-Clean	3. Check the latch switch: - Disconnect the wires from the switch terminals and measure the continuity. Door Latched: Switch closed, meter should indicate 0 Ω (closed circuit). Door Unlatched: Switch open, meter should indicate infinity (open circuit).
			4. Check the door open/closed switch: - Disconnect the wires from the switch terminals and measure the continuity. Door Open: Switch closed, meter should indicate 0 Ω (closed circuit). Door Closed: Switch open, meter should indicate infinity (open circuit).
			5. Replace electronic control.
All other F codes		Electronic control malfunction	Replace electronic control.

MICROWAVE OVEN RELAY LOGIC

MODES	RELAYS		MAGNETRON	GRILL	MAGNETRON FAN	LIGHT	UPPER BLOWER	LOWER BLOWER
MICRO. FULL PWR	X	O	X	X	X	X	⊗	⊗
MICRO. VAR. PWR	⌒	O	X	X	X	X	⊗	⊗
MANUAL CRISP	⌒	X	X	X	X	X	⊗	⊗
GRILL	⌒	X	X	X	X	X	⊗	⊗
OFF	O	O	O	⊗	⊗	⊗	⊗	⊗

RELAY LOGIC KEY

O = OFF

X = ON

⌒ = CYCLING (MAX. PERIOD = 23 SEC.)

+ = CYCLING (MAX. PERIOD = 60 SEC.)

⊗ = ON OR OFF

* = PULSED FOR 1/2 SECOND

MICROWAVE OVEN POWER OUTPUT TEST

The power output of the magnetron can be measured by the following test: (for accurate results, the line voltage must be 120 VAC and the oven cavity must be clean).

1. Fill a glass measuring cup with 16 oz. (453 cc) of tap water. Stir the thermometer through the water until the temperature stabilizes.
2. Place the cup of water in the center of the oven. Operate on HIGH for 60 seconds.

LOWER OVEN RELAY LOGIC

MODES	RELAYS		BAKE	BROIL	OVEN LIGHT	PULSE RELAY	LOCK/UNLOCK	UPPER BLOWER	LOWER BLOWER
OFF	O	O	⊗	⊗	O	O	⊗	⊗	⊗
BAKE ■	+	+	⊗	O	O	X	X	X	
BROIL ●	O	X	⊗	O	O	X	X	X	
CLEAN ▲	+	+	O	*	*	X	X	X	
■ PREHEAT-BAKE	+	+	⊗	O	O	X	X	X	
▲ PREHEAT-CLEAN	+	+	O	*	*	X	X	X	
● PREHEAT-BROIL	O	X	⊗	O	O	X	X	X	

* If the lower oven is in the Clean Mode, the microwave will not function.

3. Stir the thermometer through the water and record the maximum temperature.
4. Subtract the cold water temperature from the hot water temperature. The normal result should be a 20 - 38° F (11.1 - 21.1° C) rise in temperature.

NOTE: Less than a 20° F (11.1° C) temperature rise may indicate an operating voltage of less than 110 volts or a low power output from the magnetron. Cooking time can be adjusted to compensate for either circumstance. Replace the magnetron only if the water temperature rise indicates a power output well beyond the normal result.

WIRING DIAGRAMS & STRIP CIRCUITS

SCHEMATIC DIAGRAM 1

WIRE HARNESS SCHEMATIC

NOTES: When replacing the electronic control, be sure to attach the cavity select line to the proper terminal (see "CAVITY SIZE" table below).
Dots indicate connections or splices.
Circuit shown in standby/off mode with microwave oven door and lower oven door open.

T.O.D. (RESETTABLE)		LIGHT		HEATING ELEMENT	
THERMAL FUSE/T.O.D. (NON-RESETTABLE ONE TIME)		AC DRIVE MOTOR		SOLENOID	
GROUND (CHASSIS)		RELAY COIL		ENCLOSED THERMISTOR	
PLUG WITH FEMALE CONNECTOR		RELAY CONTACTS		OPERATED BY DOOR	
RECEPTACLE WITH MALE CONNECTOR					

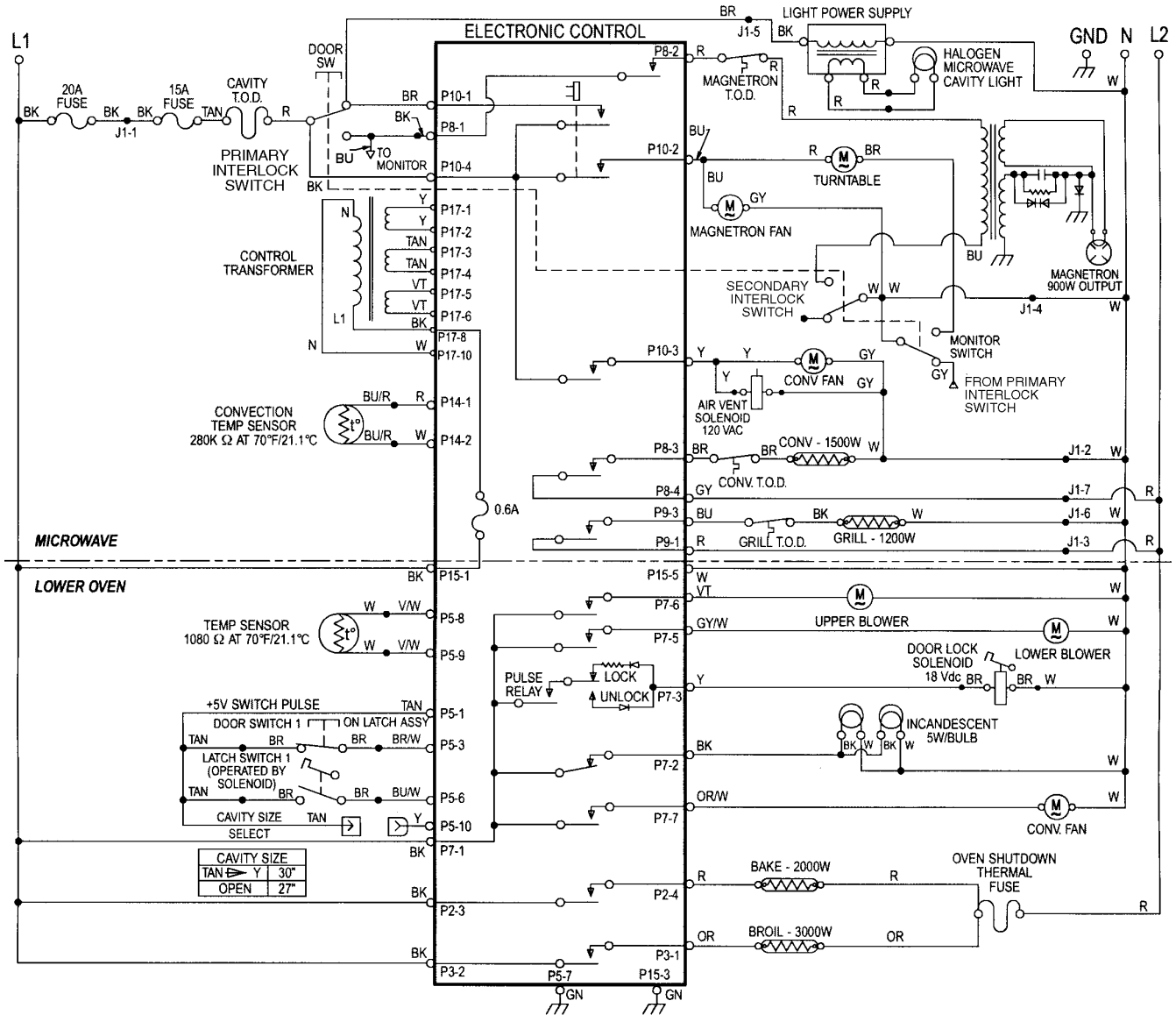

PART NUMBER 8300283 REV. D

SCHEMATIC DIAGRAM 2

WIRE HARNESS SCHEMATIC

NOTES: When replacing the electronic control, be sure to attach the cavity select line to the proper terminal (see "CAVITY SIZE" table below).
 Dots indicate connections or splices.
 Circuit shown in standby/off mode with microwave oven door and lower oven door open.

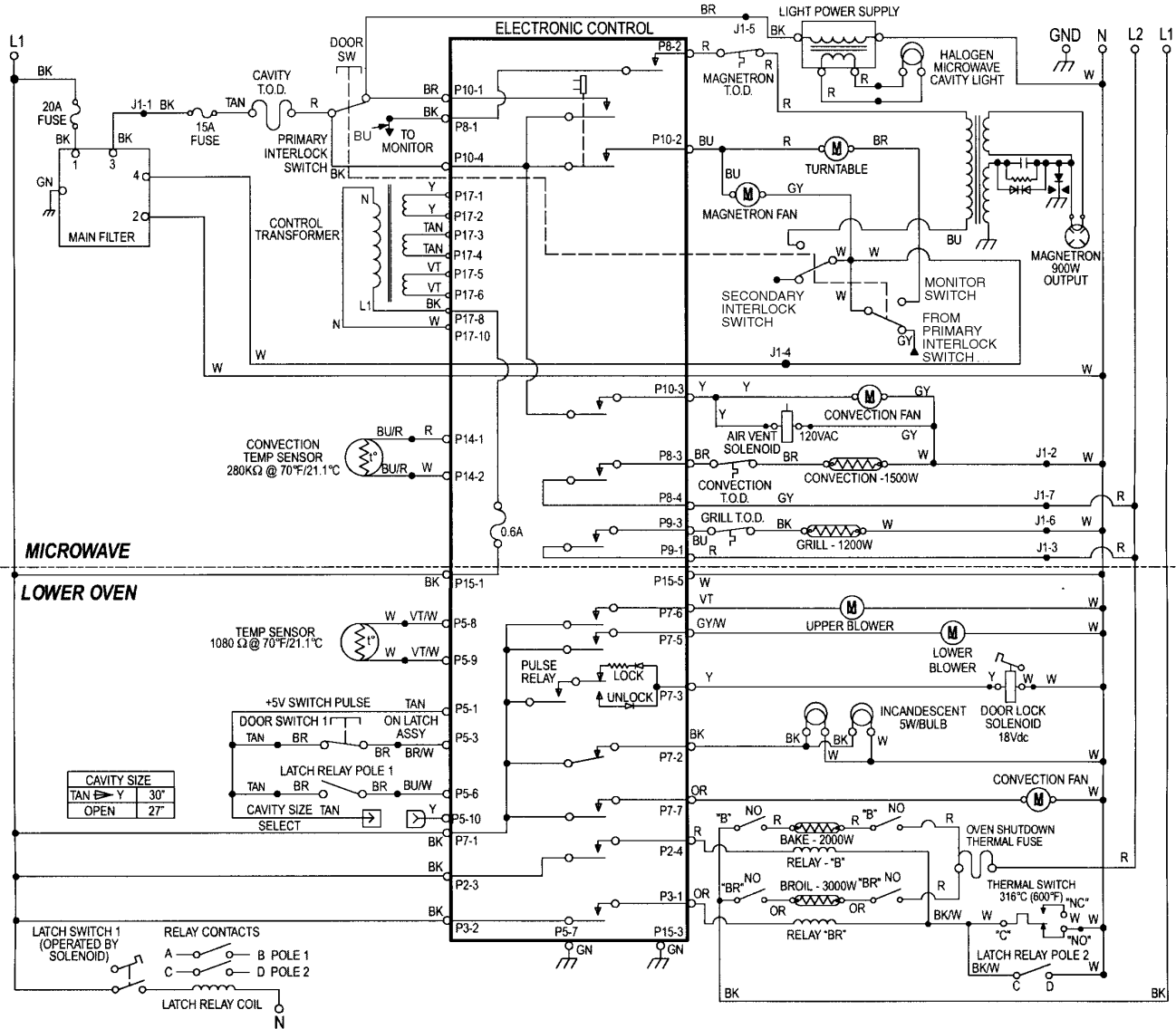
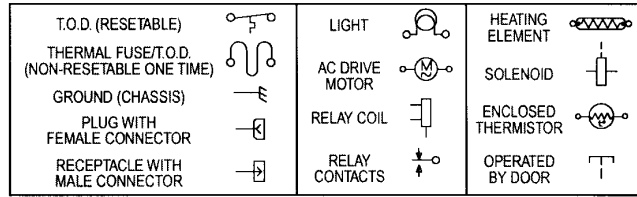

PART NUMBER 8300542 REV. A

SCHEMATIC DIAGRAM 3

WIRE HARNESS SCHEMATIC

NOTES: When replacing the electronic control, be sure to attach the cavity select line to the proper terminal (see "CAVITY SIZE" table below).

Dots indicate connections or splices.

Circuit shown in STANDBY/OFF mode with microwave oven door and lower oven door open.

T.O.D. (RESETABLE)		LIGHT		HEATING ELEMENT	
THERMAL FUSE/T.O.D. (NON-RESETABLE ONE TIME)		AC DRIVE MOTOR		SOLENOID	
GROUND (CHASSIS)		RELAY COIL		ENCLOSED THERMISTOR	
PLUG WITH FEMALE CONNECTOR		RELAY CONTACTS		OPERATED BY DOOR	
RECEPTACLE WITH MALE CONNECTOR					

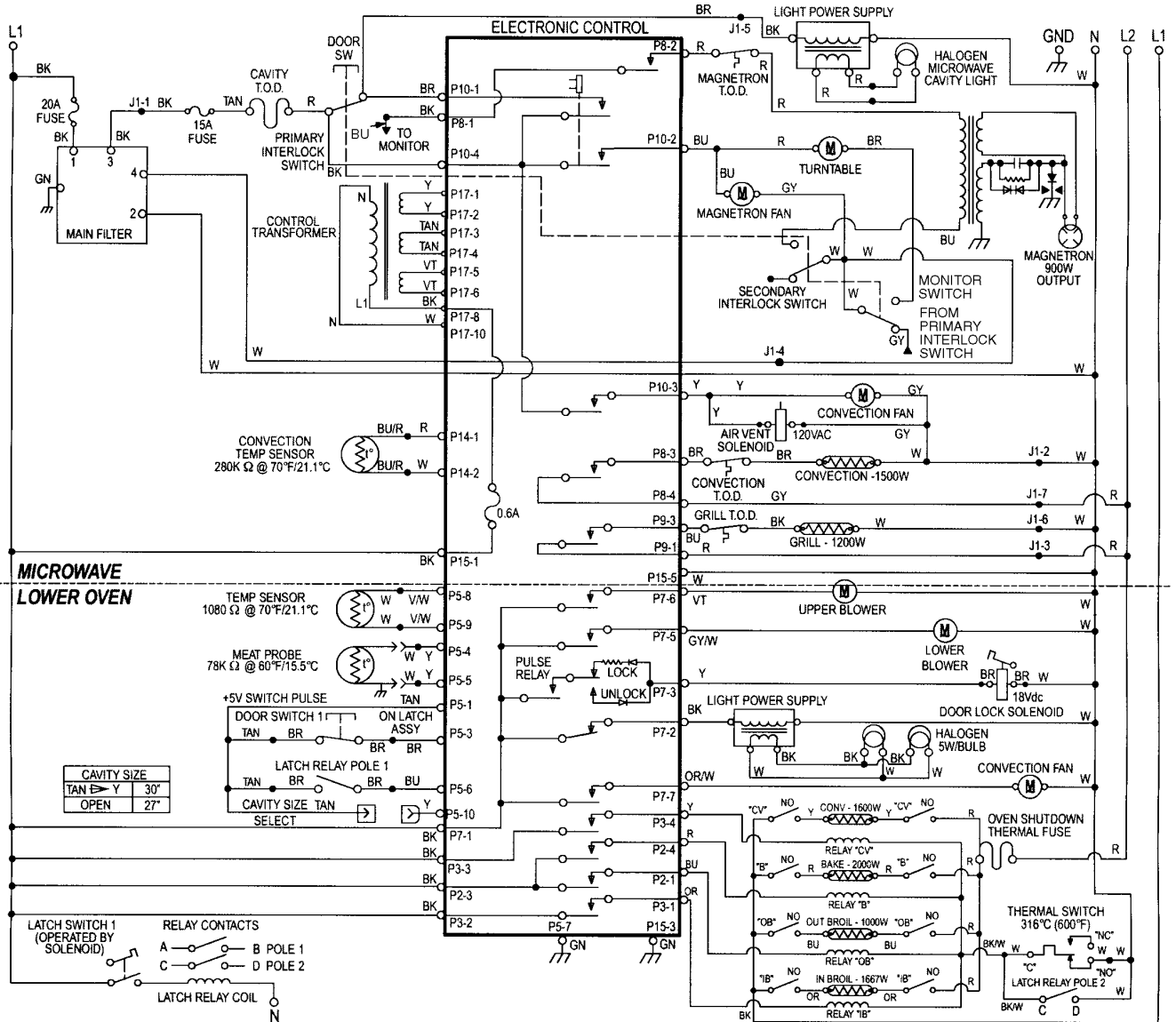

PART NUMBER 8300543 REV. A

SCHEMATIC DIAGRAM 4

WIRE HARNESS SCHEMATIC

NOTES:

WHEN REPLACING THE ELECTRONIC CONTROL, BE SURE TO ATTACH THE CAVITY SELECT LINE TO THE PROPER TERMINAL (SEE "CAVITY SIZE" TABLE BELOW).

DOTS INDICATE CONNECTIONS OR SPLICES.

CIRCUIT SHOWN IN STANDBY/OFF MODE WITH MICROWAVE OVEN DOOR AND LOWER OVEN DOOR OPEN.

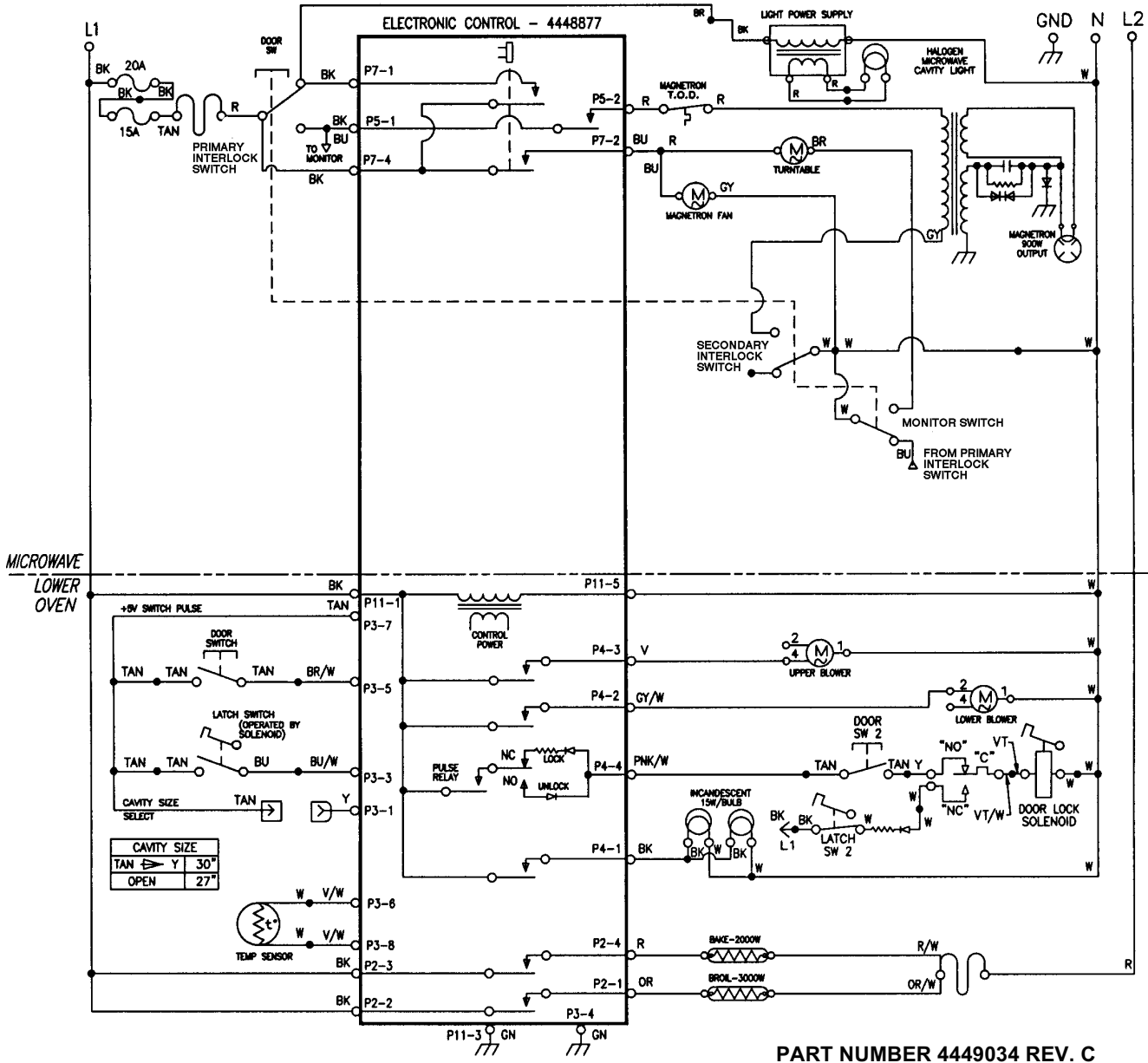
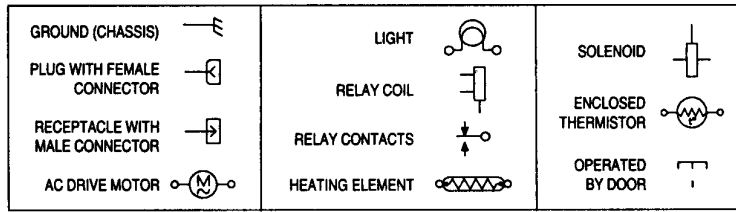

PART NUMBER 4449034 REV. C

WIRING DIAGRAM

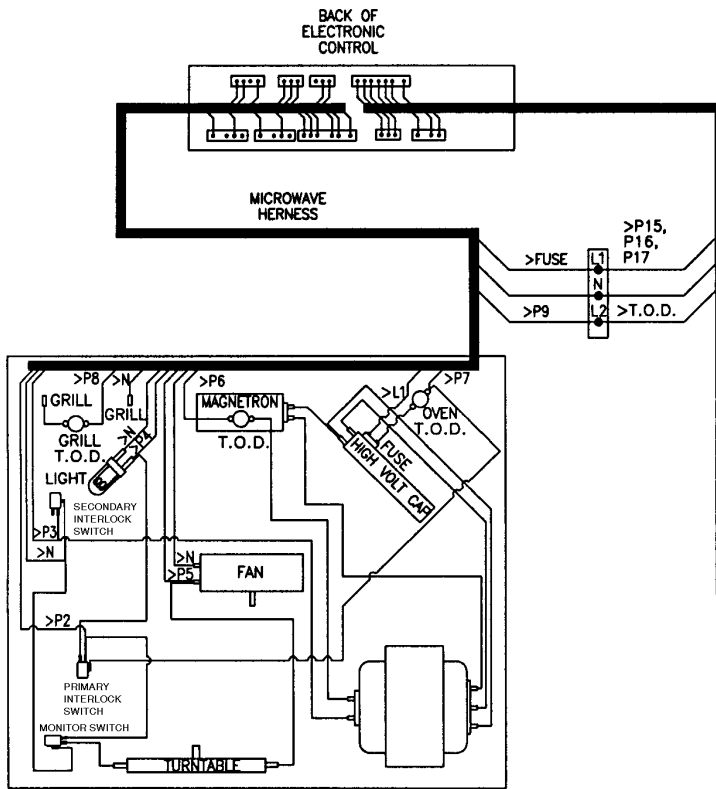

SIDE VIEW
MICROWAVE OVEN

PART NUMBER 4449034 REV. C

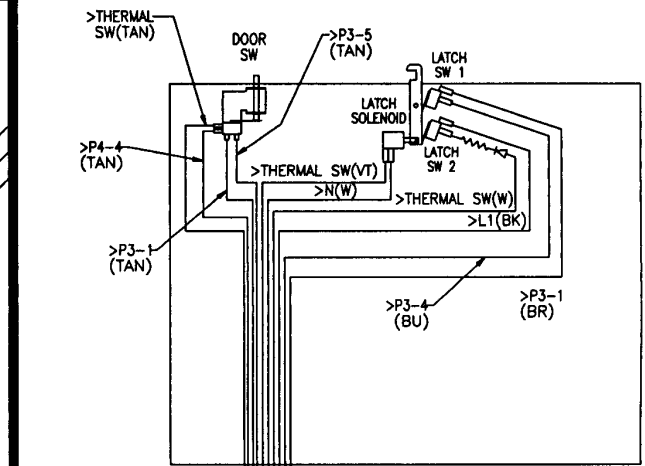

TOP VIEW

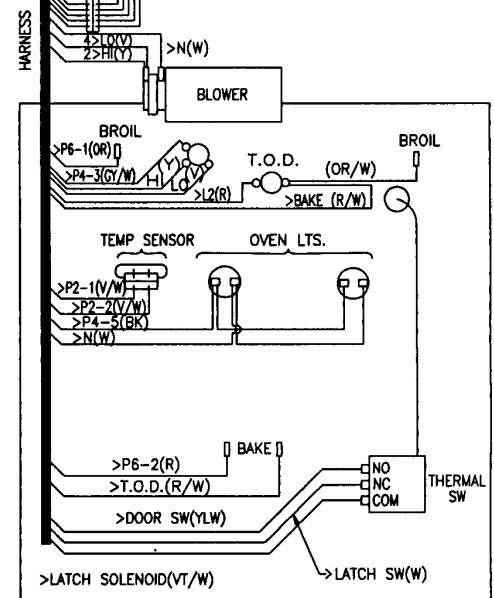

BACK VIEW
LOWER OVEN

STRIP CIRCUITS

BAKE AND PREHEAT BAKE

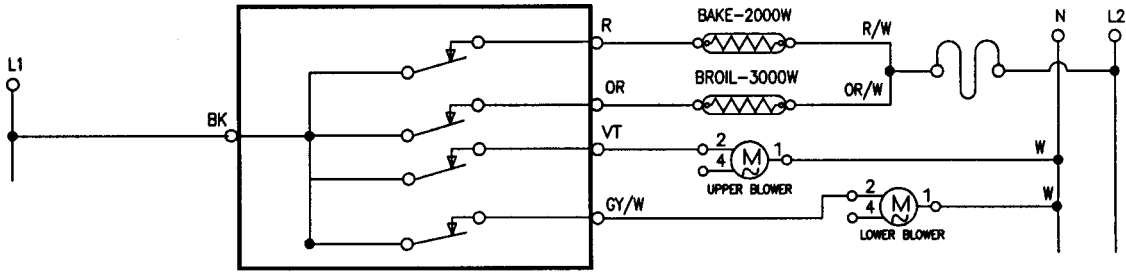

BROIL

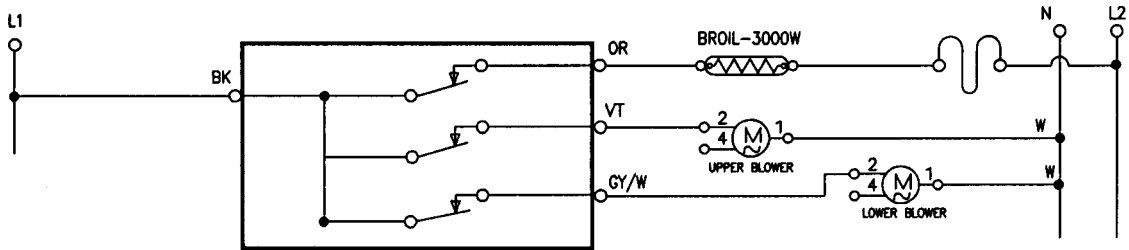

CLEAN (ABOVE 600 °F)

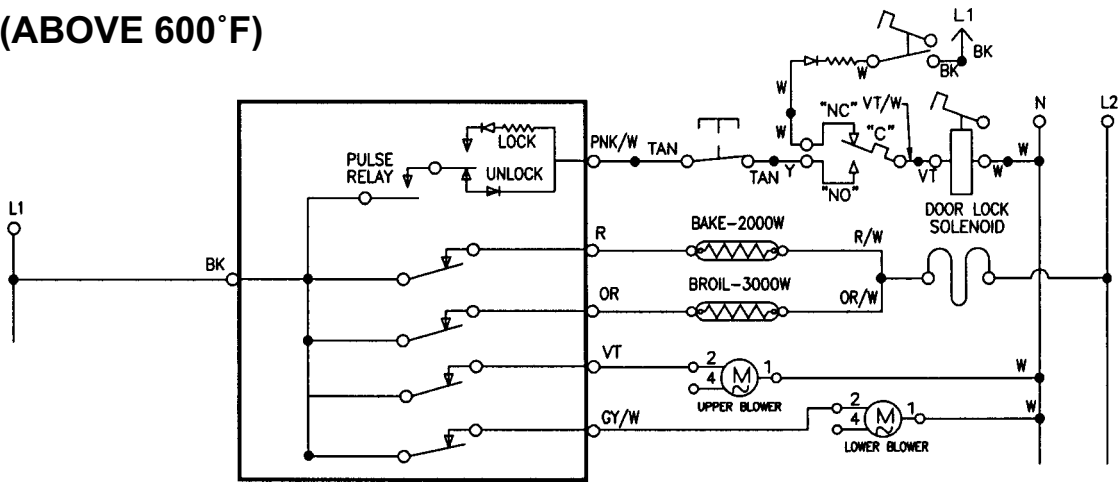

PREHEAT CLEAN (BELOW 600 °F)

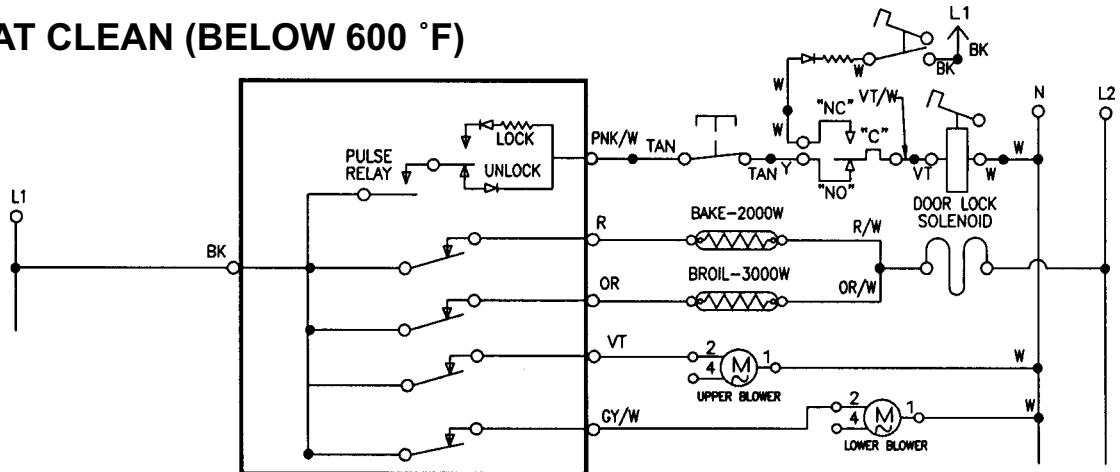

MICROWAVE FULL POWER / VARIABLE POWER

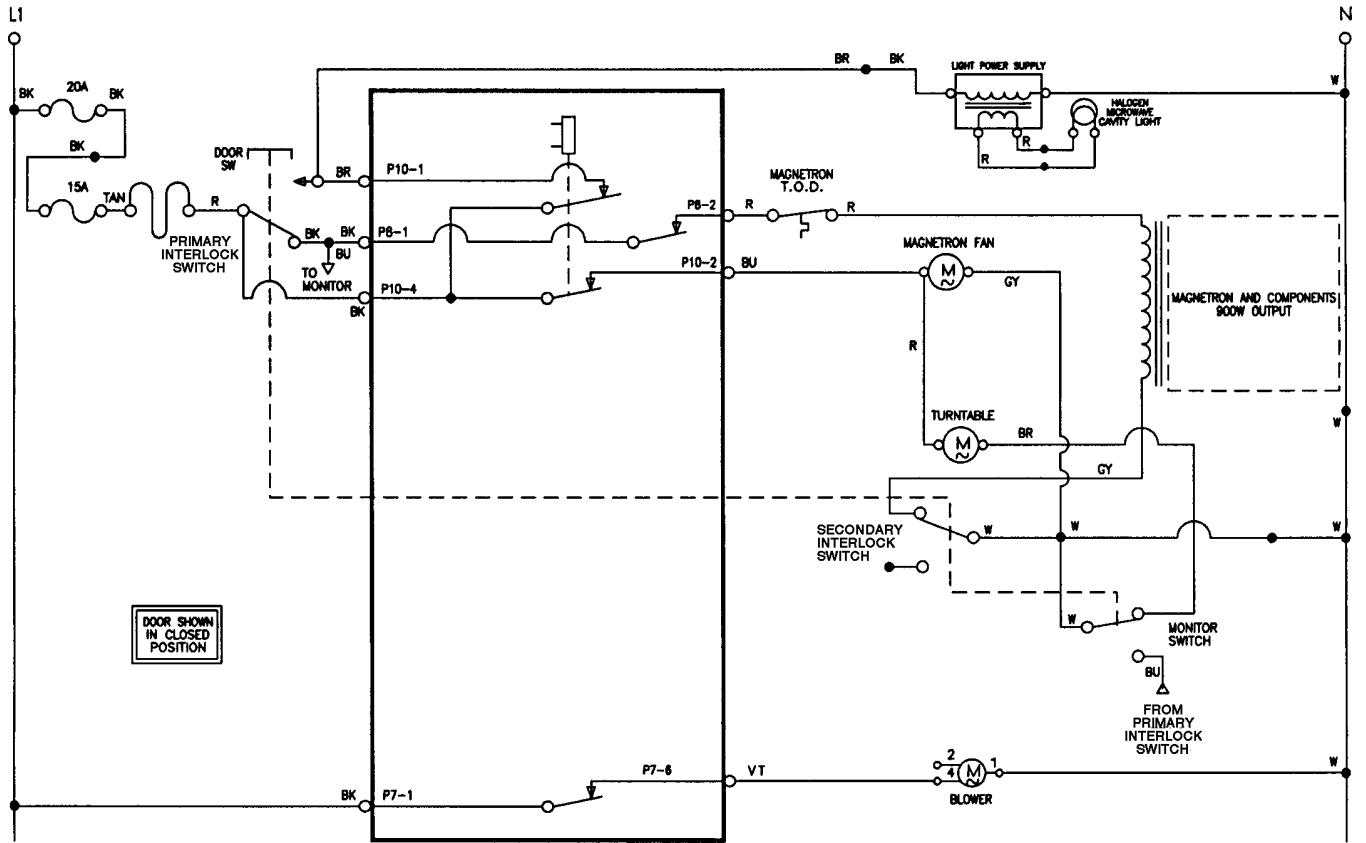

— NOTES —

— NOTES —

— NOTES —

PRODUCT SPECIFICATIONS AND WARRANTY INFORMATION SOURCES

IN THE UNITED STATES:

FOR PRODUCT SPECIFICATIONS AND WARRANTY INFORMATION CALL:

FOR WHIRLPOOL PRODUCTS: 1-800-253-1301
FOR KITCHENAID PRODUCTS: 1-800-422-1230
FOR ROPER PRODUCTS: 1-800-447-6737

FOR TECHNICAL ASSISTANCE WHILE AT THE CUSTOMER'S HOME CALL:

THE TECHNICAL ASSISTANCE LINE: 1-800-253-2870

**HAVE YOUR STORE NUMBER READY TO IDENTIFY YOU AS AN
AUTHORIZED SERVICER**

FOR LITERATURE ORDERS:

PHONE: 1-800-851-4605

IN CANADA:

FOR PRODUCT SPECIFICATIONS AND WARRANTY INFORMATION CALL:

1-800-461-5681

FOR TECHNICAL ASSISTANCE WHILE AT THE CUSTOMER'S HOME CALL:

THE TECHNICAL ASSISTANCE LINE: 1-800-488-4791

**HAVE YOUR STORE NUMBER READY TO IDENTIFY YOU AS AN
AUTHORIZED SERVICER**

KitchenAid®
FOR THE WAY IT'S MADE.®

