

KitchenAid

TECHNICAL EDUCATION

36" & 48" ISLAND AND WALL CANOPY RANGE HOODS

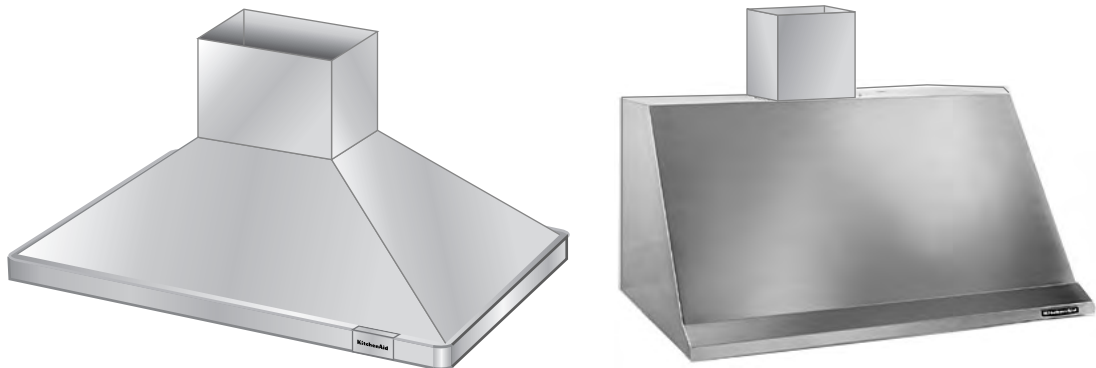

FORWARD

This Job Aid, KitchenAid “36” and 48” Island And Wall Canopy Range Hoods,” (Part No. 4317332), provides the technician with information on servicing the Island And Wall Canopy Range Hoods. It is to be used as a training Job Aid and Service Manual. For specific information on the model being serviced, refer to the “Use and Care Guide” provided with the hood.

The Wiring Diagrams used in this Job Aid are typical and should be used for training purposes only. Always use the Wiring Diagram supplied with the product when servicing the unit.

GOALS AND OBJECTIVES

The goal of this Job Aid is to provide detailed information that will enable the service technician to properly diagnose malfunctions and repair the KitchenAid Island And Wall Canopy Range Hoods.

The objectives of this Job Aid are to:

- Understand and follow proper safety precautions.
- Successfully troubleshoot and diagnose malfunctions.
- Successfully perform necessary repairs.
- Successfully return the range hood to its proper operational status.

WHIRLPOOL CORPORATION assumes no responsibility for any repairs made on our products by anyone other than Authorized Service Technicians.

TABLE OF CONTENTS

	Page
GENERAL	1-1
Important Safety Information	1-1
KitchenAid Model & Serial Number Designations	1-2
Model & Serial Number Label Location	1-3
Specifications	1-4
KitchenAid Range Hood Warranty	1-7
COMPONENT ACCESS	2-1
Wall Hood Component Locations	2-1
Removing A Slide Switch, The Indicator Lamp, & The Blower Motor	2-2
Removing A Halogen Lamp Socket	2-5
Island Hood Component Locations	2-6
Removing The Ballast Transformer	2-7
Removing The Control Board	2-8
Removing The Blower Motor	2-10
COMPONENT TESTING	3-1
Blower Motor	3-1
Ballast Transformer	3-1
2- & 3-Position Slide Switches	3-2
Speed (Variable) Control	3-2
WIRING DIAGRAMS	4-1
Island Hood	4-1
Wall Hood	4-2

— NOTES —

GENERAL

IMPORTANT SAFETY INFORMATION

Your safety and the safety of others is very important.

Important safety messages have been provided in this Job Aid. Always read and obey all safety messages.



This is the safety alert symbol. This symbol alerts you to hazards that can kill or hurt you and others.

All safety messages will be preceded by the safety alert symbol and the word **“WARNING.”**

All safety messages will identify the hazard, tell you how to reduce the chance of injury, and tell you what can happen if the instructions are not followed.

 **WARNING**

ELECTRICAL SHOCK HAZARD

Disconnect power before servicing.

Replace all panels before operating.

Failure to do so could result in death or electrical shock.

KITCHENAID MODEL & SERIAL NUMBER DESIGNATIONS

MODEL NUMBER

MODEL NUMBER			K	WC	U	38	0	J	SS	0
INTERNATIONAL SALES IND. OR MARKETING CHANNEL IF PRESENT										
PRODUCT GROUP K = KITCHENAID BRAND										
PRODUCT IDENTIFICATION IC = ISLAND HOOD IV = ISLAND VENT IR = ISLAND RETRACTABLE WV = WALL VENT PI = POWER INTERIOR PE = POWER EXTERIOR SV = SIDE VENT WC = WALL CANOPY										
MERCHANDISING SCHEME D = DOWNDRAFT U = UPDRAFT										
CAPACITY / SIZE / SERIES / CONFIGURATION										
<u>1ST POSITION</u>	<u>2ND POSITION</u>									
0 = SIDE DOWNDRAFT	0 = 30" WIDE									
1 = STANDARD UPDRAFT	5 = 500 CFM									
2 = SLIDE-OUT UPDRAFT	6 = 36" WIDE									
3 = CANOPY	8 = 48" WIDE									
8 = DOWNDRAFT	9 = 900 CFM									
FEATURES 0 = STANDARD 1 = INTERIOR POWER 2 = EXTERNAL POWER 5 = ELECTRONIC CONTROLS										
YEAR OF INTRODUCTION H = 1999 J = 2000 K = 2001										
COLOR CODE WT = WHITE BT = BISCUIT SS = BRUSHED STAINLESS STEEL										
ENGINEERING CHANGE (0, 1, 2, ETC.)										

SERIAL NUMBER

SERIAL NUMBER			F J	J	4 6	0 2 4 5 3
MANUFACTURING SITE						
YEAR OF PRODUCTION J = 1999, K = 2000, L = 2001, M = 2002						
WEEK OF PRODUCTION 46TH WEEK						
PRODUCT SEQUENCE NUMBER						

MODEL & SERIAL NUMBER LABEL LOCATION

The Model/Serial Number label locations are shown below.

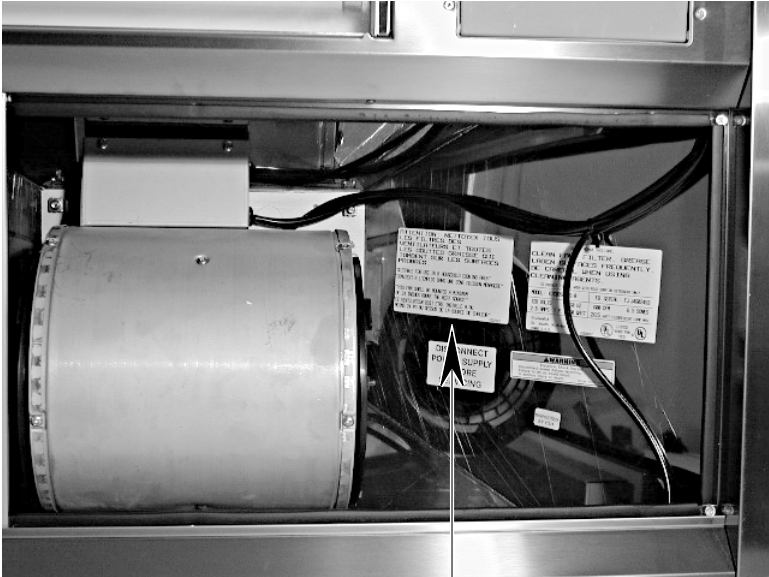

**Model & Serial Number Location
(Island Range Hood)**

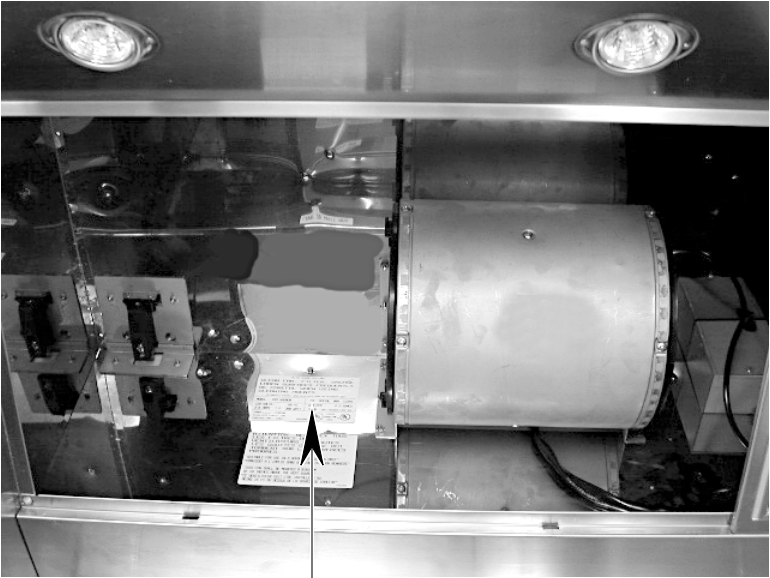

**Model & Serial Number Location
(Wall Range Hood)**

SPECIFICATIONS

Island Hoods

Model Number	KICU265H SS, WT, BT	KICU285H SS, WT, BT
Dimensions/Specifications		
Overall Width (in)	35 3/8"	47 1/4"
Overall Depth (in)	23 5/8"	23 5/8"
Canopy Height (in)	10 1/4"	10 1/4"
Chimney Height (in)	24 5/8" to 34 3/4"	24 5/8" to 34 3/4"
Weight		
Net Weight (lbs)	77	84
Shipping Weight (lbs)	82	90
Ratings		
120v AC	Yes	Yes
Circuit Amps	15 AMP	15 AMP
Exterior		
Hood Exterior		
Type/Configuration	Canopy-Updraft	Canopy-Updraft
Size (Inches)	36 Inches	48 Inches
Color	Stainless	Stainless
Grease Filters	3 Heavy Duty (DW Safe)	3 Heavy Duty (DW Safe)
CFM	600	600
Sones	6.5	6.5
Light	2 Fluorescent Bulbs	2 Fluorescent Bulbs
Brand Logo Location	KitchenAid	KitchenAid
Controls		
On/Off	Yes	Yes
Variable Speed	Yes	Yes
Auto Off	No	No
Interior		
Ducting	Convertible with kit	Convertible with kit
Dimension	3 1/4" x 10"	3 1/4" x 10"
Accessories		
Backsplash		
Backsplash Kit Part/Description		
Ductless Operation Kit Part/Description	4378625/Stainless	4378625/Stainless
Chimney Extension Kit		
Wire Rack Kit Part/Description		
Wire Rack Hanger Kit Part/Description		
Utensil Bar-15 Inch Sides Kit	4378619	4378619
Utensil Bar-Back		
Miscellaneous		
Product Literature		
Installation Instructions Part/Comment	4360369	4360369
Job Aid Part/Comment	4317332	4317332
Use & Care Guide Part/Comment	4360369/English; 4360370/French	4360369/English; 4360370/French
Wiring Diagram Part/Comment	In Use and Care Guide	In Use and Care Guide
Other		
Agency Approvals	UL,CUL	UL,CUL
Warranty		
Full (Months)	12	12
Power System Motor	48 Mo	48 Mo

Wall Hoods

Model Number	KWCU205H SS, WT, BT	KWCU265H SS, WT, BT	KWCU285H SS, WT, BT
Dimensions/Specifications			
Overall Width (in)	29 7/8"	35 3/8"	47 1/4"
Overall Depth (in)	19 1/4"	19 1/4"	19 1/4"
Canopy Height (in)	9 1/2"	9 1/2"	9 1/2"
Chimney Height (in)	23" to 42"	23" to 42"	23" to 42"
Weight			
Net Weight (lbs)	45	52	59
Shipping Weight (lbs)	49	57	65
Ratings			
120v AC	Yes	Yes	Yes
Circuit Amps	15 AMP	15 AMP	15 AMP
Exterior			
Hood Exterior			
Type/Configuration	Wall-Updraft	Wall-Updraft	Wall-Updraft
Size (Inches)	30 Inches	36 Inches	48 Inches
Color	Stainless	Stainless	Stainless
Grease Filters	2 Heavy Duty (DW Safe)	3 Heavy Duty (DW Safe)	3 Heavy Duty (DW Safe)
CFM	600	600	600
Sones	6.5	6.5	6.5
Light	1 Fluorescent Bulb	1 Fluorescent Bulb	1 Fluorescent Bulb
Brand Logo Location	KitchenAid	KitchenAid	KitchenAid
Controls			
On/Off	Yes	Yes	Yes
Variable Speed	Yes	Yes	Yes
Auto Off	No	No	No
Interior			
Ducting	Convertible with kit	Convertible with kit	Convertible with kit
Dimension	3 1/4" x 10"	3 1/4" x 10"	3 1/4" x 10"
Accessories			
Backsplash			
Backsplash Kit Part/Description	8171295/Stainless	4378615/Stainless	8171296/Stainless
Ductless Operation Kit Part/Description	4378621/Stainless	4378621/Stainless	4378621/Stainless
Chimney Extension Kit	N/A	N/A	N/A
Wire Rack Kit Part/Description	8171297	4378616	8171298
Wire Rack Hanger Kit Part/Description	4378617	4378617	4378617
Utensil Bar-15 Inch Sides Kit	4378619	4378619	4378619
Utensil Bar-Back	8171299	4378618	
Miscellaneous			
Product Literature			
Installation Instructions Part/Comment			
Job Aid Part/Comment	4317332	4317332	4317332
Use & Care Guide Part/Comment	4360367/English; 4360368/French	4360367/English; 4360368/French	4360367/English; 4360368/French
Wiring Diagram Part/Comment	In Use & Care Guide	In Use & Care Guide	In Use & Care Guide
Other			
Agency Approvals	UL,CUL	UL,CUL	UL,CUL
Warranty			
Full (Months)	12	12	12
Power System Motor	48 Mo	48 Mo	48 Mo

Model Number	KWCU380JSS	KWCU360JSS
Size-Configuration	48" - Wall Canopy	36" - Wall Canopy
Feature Level/Series	Professional Series	Professional Series
Dimensions/Specifications		
Exterior Dimensions		
Overall Width (in)	48"	36"
Overall Depth (in)	25"	25"
Canopy Height (in)	18"	18"
Chimney Height (in)	Accessory	Accessory
Other Dimensions		
Net Weight (lbs)	79	54
Shipping Weight (lbs)	116	84
Ratings		
Electric Voltage/Phase/Frequency (Hz)	60 HZ	60 HZ
120v AC	Yes	Yes
Circuit Amps	15	15
Exterior		
Hood Exterior		
Type/Configuration	Wall-Updraft	Wall-Updraft
Size (Inches)	48 Inches	36 Inches
Color	Stainless	Stainless
Grease Filters	Baffle	Baffle
Power System	Internal	Internal
CFM	1200	600
Sones	Maximum 6.5	Maximum 6.5
Light	4 Halogen Lights (12V 20 watt, Included)	3 Halogen Lights (12 V 20 watt, Included)
Warming Lamp	No Heat Lamps	No Heat Lamps
Control Area	Under Canopy	Under Canopy
Controls	3 Slide Switches	3 Slide Switches
Light On/Off	Yes	Yes
Blower On/Off	Yes	Yes
Variable Speed	No	No
Number of Speeds	3	3
Auto Off	No	No
Interior		
Ducting		
Ducting	Top or Rear Vented	Top or Rear Vented
Dimension	Rectangular 3 1/4" x 10"	Rectangular 3 1/4" x 10"
Accessories		
Backsplash		
Backsplash	Optional	Optional
Backsplash Kit Part/Description	8284755/Stainless; telescopic, height extends up to 39" high	8284756/Stainless; telescopic, height extends up to 39"
Chimney Extension Kit	Optional - 2 Choices	Optional - 2 choices
Chimney Extension Kit Part/Description	8284752: 48"(W) x 12"(H) or 8284754: 24"(W) x 12" to 24"(H) (Height expands to 8' - 9' ceilings)	8284753: 36"(W) x 12"(H) or 8284754: 24"(W) x 12" to 24" (H) (Height expands to 8' - 9' Ceilings)
Comment	Discharge Transition = 8284757: Transitions from two 3 1/4" x 10" to One 10" Rnd (not for use w/chimney kit 8284754)	
Miscellaneous		
Product Literature		
Installation Instructions Part/Comment	8284601	8284601
Use & Care Guide Part/Comment	w/installation instructions, 8284601	w/installation instructions, 8284601
Job Aid	4317332	4317332
Other		
Agency Approvals	UL,CUL	UL,CUL
Warranty		
Full (Months)	12	12
Power System Motor	48 Mo	48 Mo

KITCHENAID RANGE HOOD WARRANTY

LENGTH OF WARRANTY:	KITCHENAID WILL PAY FOR:	KITCHENAID WILL NOT PAY FOR:
<p>LIMITED ONE-YEAR WARRANTY From Date of Purchase.</p>	<p>Labor and any parts of your range hood (except light bulbs and filters) which are defective in materials or workmanship.</p>	<p>A. Consumable parts such as light bulbs and filters. B. Service calls to: 1. Correct the installation of the range hood. 2. Instruct you how to use the range hood. 3. Replace house fuses or correct house wiring. C. Repairs when range hood is used in other than normal single-family household use. D. Pickup and delivery. This product is designed to be repaired in the home. E. Damage to the range hood resulting from accident, misuse, fire, flood, acts of God, or use of products not approved by KitchenAid.</p>

KITCHENAID SHALL NOT BE LIABLE FOR INCIDENTAL OR CONSEQUENTIAL DAMAGES.

Some states do not allow the exclusion or limitation of incidental or consequential damages, so this exclusion or limitation may not apply to you. This warranty gives you specific legal rights and you may also have other rights which vary from state to state.

Outside the United States, a different warranty may apply. For details, please contact your authorized KitchenAid dealer.

— NOTES —

COMPONENT ACCESS

This section instructs you on how to service each component inside the island and wall canopy range hoods. The wall hood components and their locations are shown below. The island hood component access begins on page 2-6.

WALL HOOD COMPONENT LOCATIONS

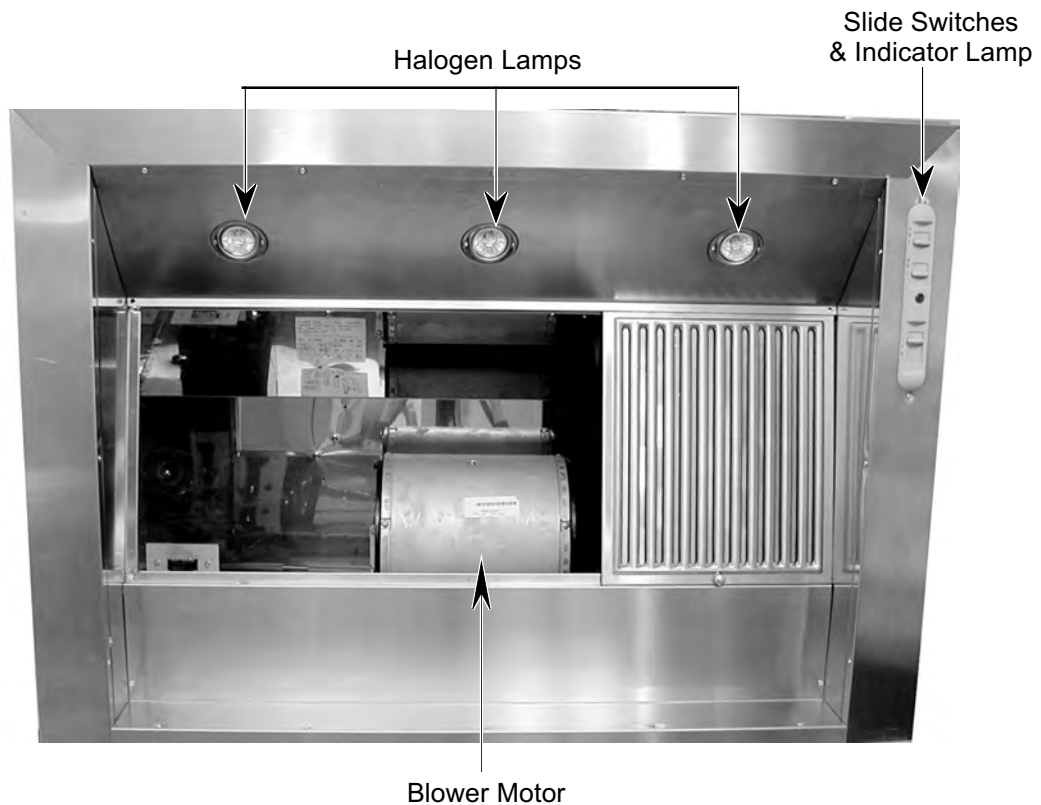

REMOVING A SLIDE SWITCH, THE INDICATOR LAMP & THE BLOWER MOTOR

! WARNING

ELECTRICAL SHOCK HAZARD

**Disconnect power before servicing.
Replace all panels before operating.
Failure to do so could result in death or
electrical shock.**

NOTE: Sharp edges may be present.

1. Disconnect the electrical power to the hood.
2. Remove the three filters from the hood.
3. Remove the two screws from the control assembly and pull the assembly around through the filter section to the front.

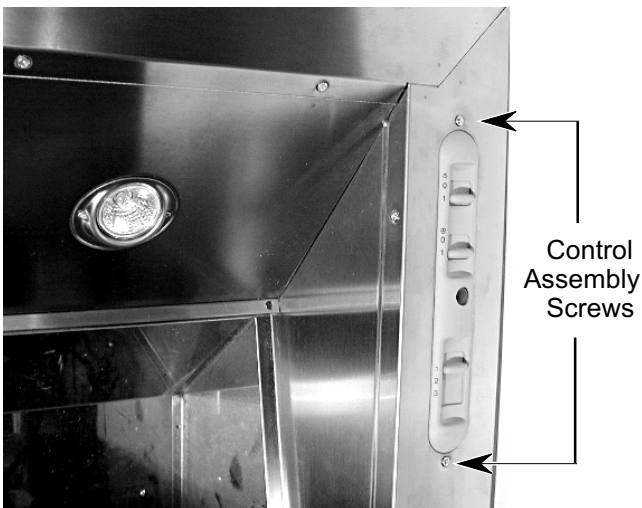

REASSEMBLY NOTE: Before you reassemble the control assembly, make sure that:

- You route the wiring carefully so that it does not become pinched between the housing sections.
- All of the switch lug wire connectors are securely over the lugs. Also check to see that the metal contacts remain inside the plastic holders and have not been pushed out.
- The slide switches operate properly before securing the housing sections.

4. Remove the three mounting screws from the control assembly cover and remove the cover.

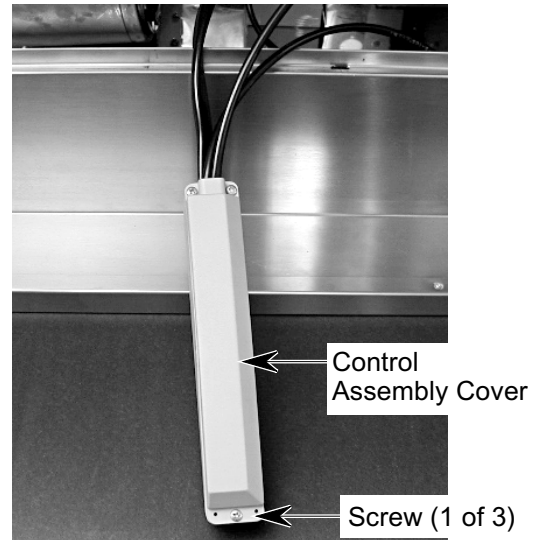

5. **To remove a slide switch:**

- a) Disconnect the wire connectors from the switch terminals.
- b) Use a small screwdriver and pry the tab on the control housing away from the switch, and push the switch out of the holder. NOTE: The control assembly wiring is shown on the next page.

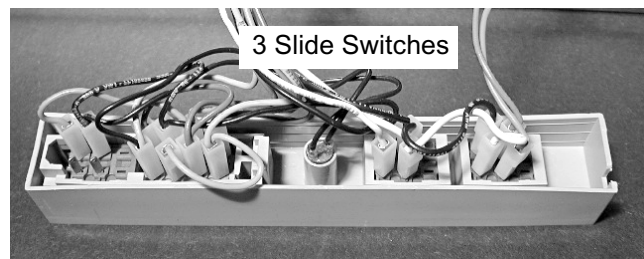

Control Housing Tab

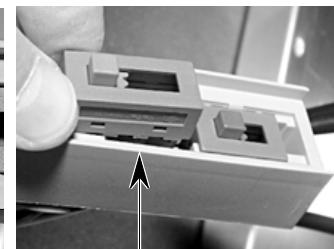
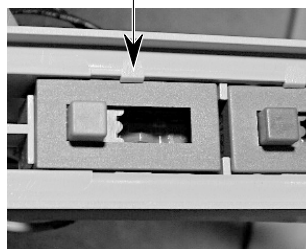

Push Switch Out
Of Housing

6. To remove the indicator lamp, pull it out of the control housing and disconnect the wires from the two slide switch terminals.

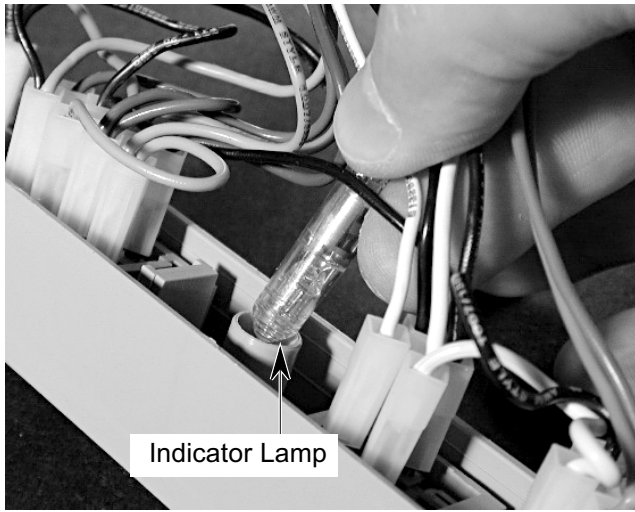

7. To remove the blower motor:
 - a) Remove the three screws from the motor mounting brackets on both sides of the blower motor (6 total).
 - b) Disconnect the wire connectors from the slide switch terminals.

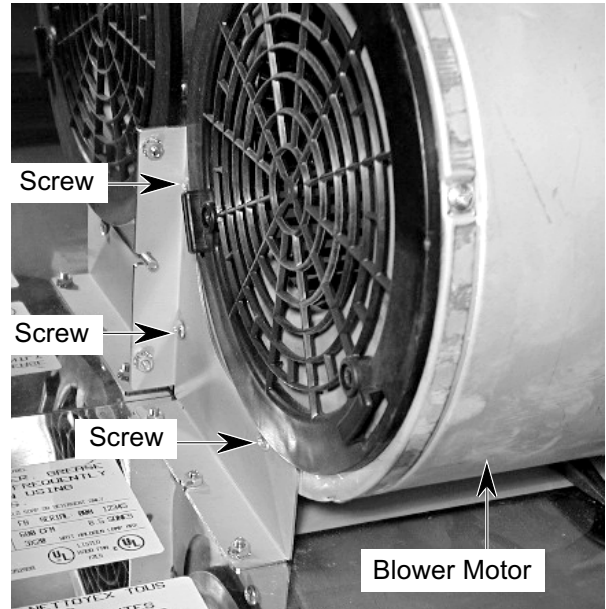

Continued on the next page.

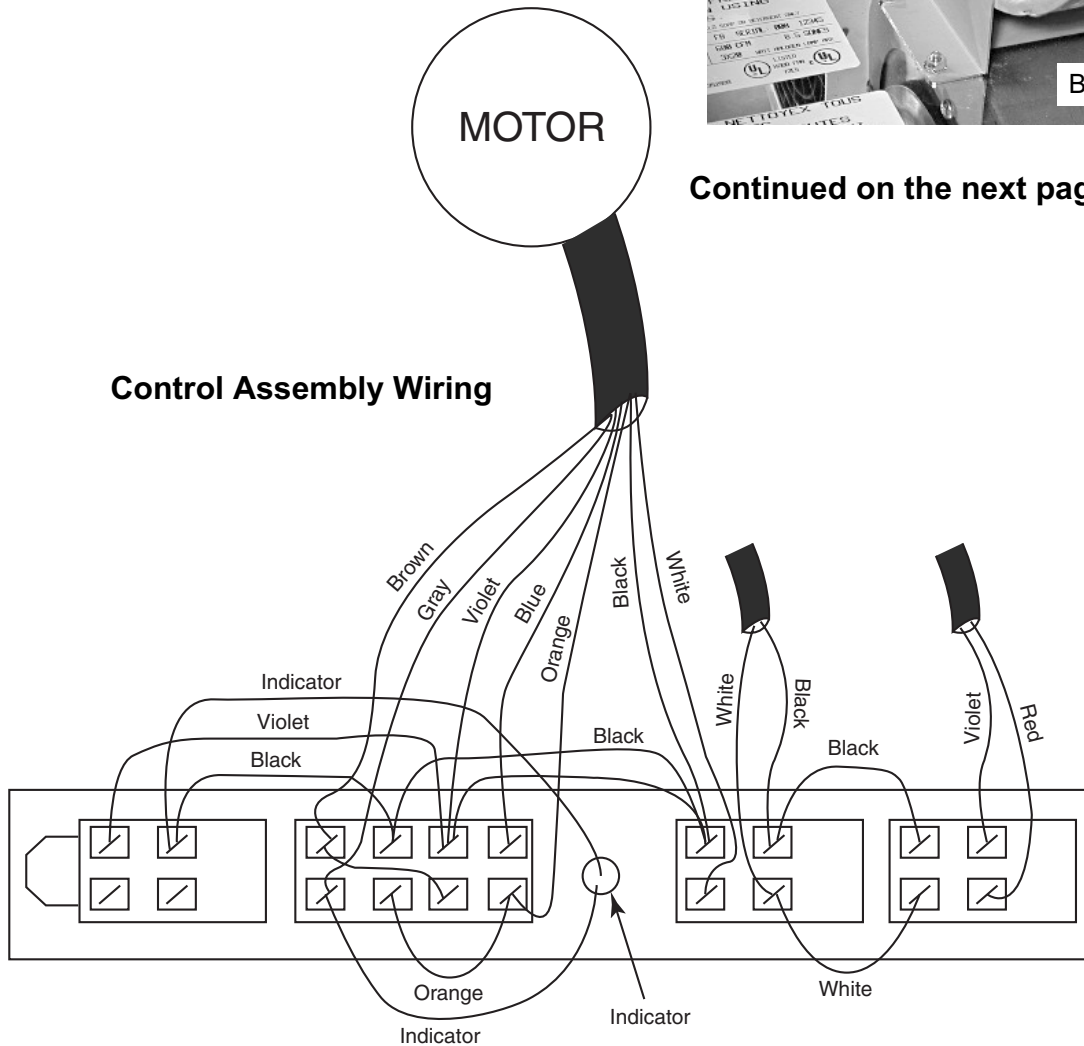

- c) Lift the cable clamp, remove the motor cable, and remove the blower motor from the hood.

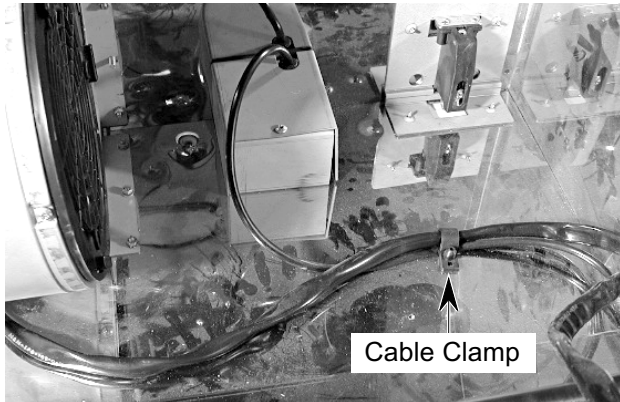

- d) Position the blower motor on a work surface on one of its sides.
e) Remove the five screws from the blower motor housing side cover that is facing up and remove the cover. NOTE: Do not remove the plastic grille from the cover.



- f) Remove the four motor bracket mounting screws from the center of the motor housing, and pull the motor and bracket out of the housing.
g) Remove the mounting nut from each of the blower wheels and remove the wheels from the blower motor.

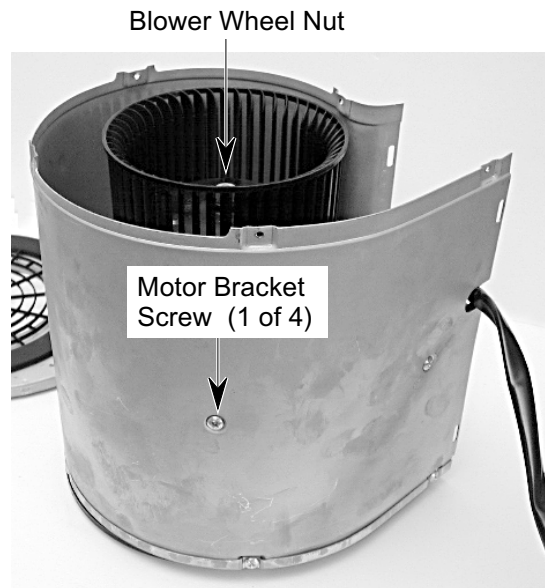

REMOVING A HALOGEN LAMP SOCKET

! WARNING

ELECTRICAL SHOCK HAZARD

**Disconnect power before servicing.
Replace all panels before operating.
Failure to do so could result in death or electrical shock.**

NOTE: Sharp edges may be present.

1. Disconnect the electrical power to the hood.
2. Remove the two screws from the halogen lamp holder and pull the holder away from the hood so the wire connectors are exposed.

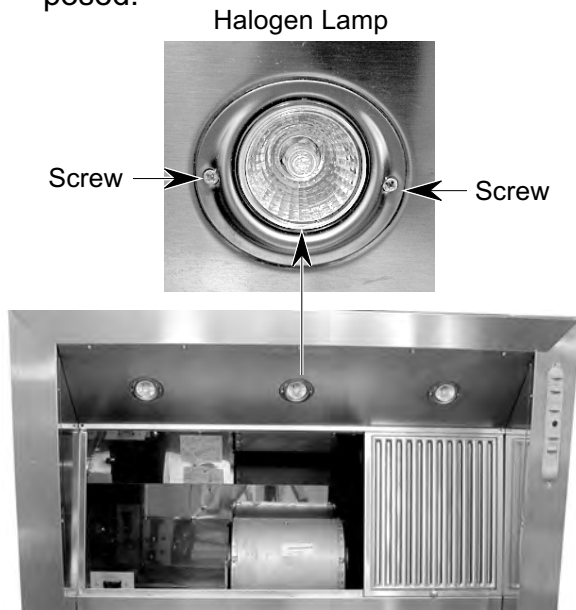

3. Remove the twist-on wire nuts from the two wires and untwist the wires.

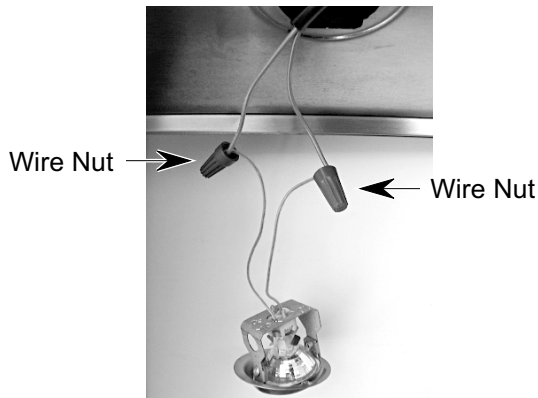

4. Pull the halogen lamp out of the socket clip and remove the lamp pins from the socket.

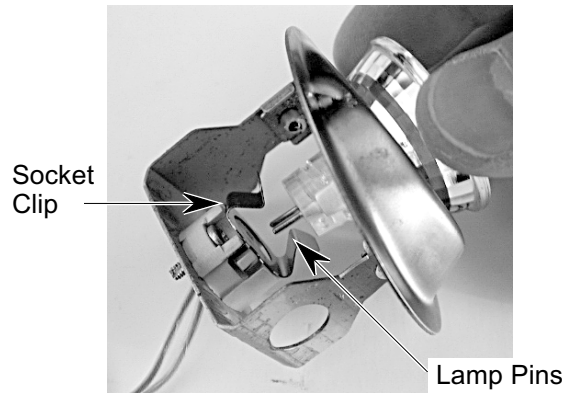

5. Remove the clip from the socket by releasing the tabs from the slots.

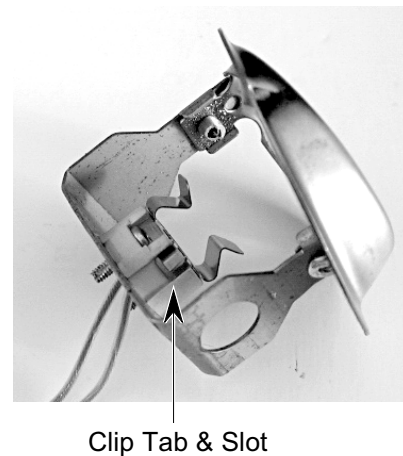

6. Remove the two screws from the socket and remove the socket from the holder.

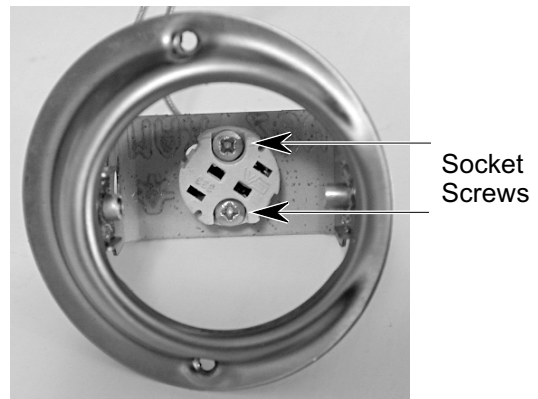

ISLAND HOOD COMPONENT LOCATIONS

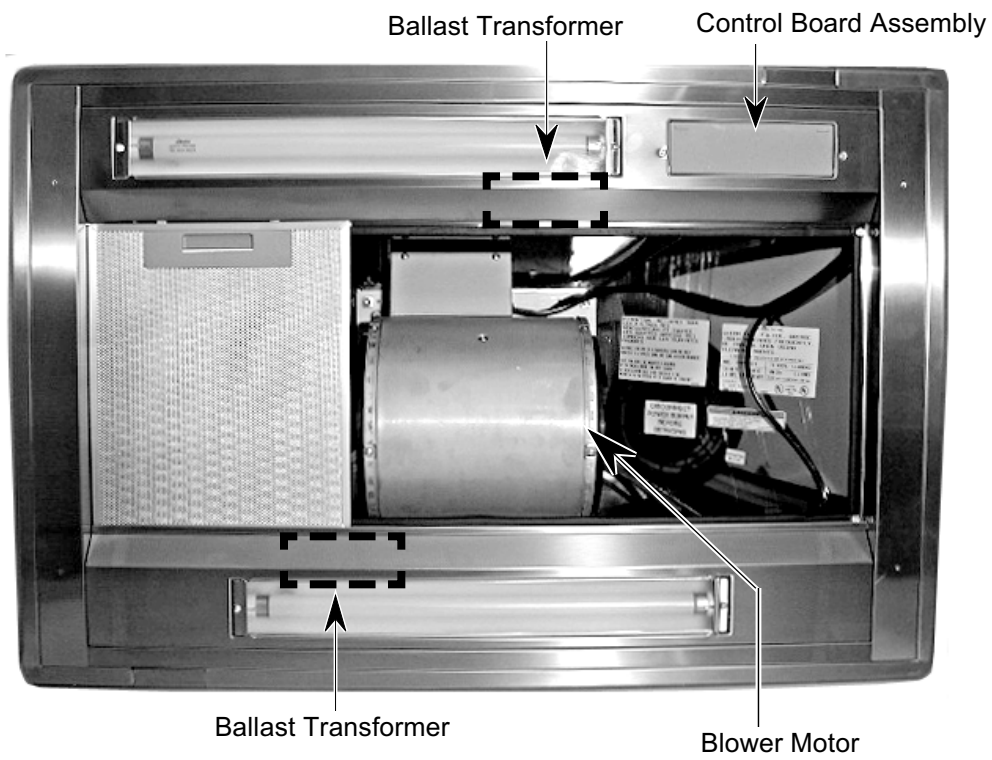

REMOVING THE BALLAST TRANSFORMER

! WARNING

ELECTRICAL SHOCK HAZARD

**Disconnect power before servicing.
Replace all panels before operating.
Failure to do so could result in death or electrical shock.**

NOTE: Sharp edges may be present..

1. Disconnect the electrical power to the hood.
2. Remove the three filters from the hood.
3. Remove the screw from each of the fluorescent lamp lens retainers and remove the retainers.



4. Slide the fluorescent lamp lens to either end of the holder and remove it from the holder tabs.

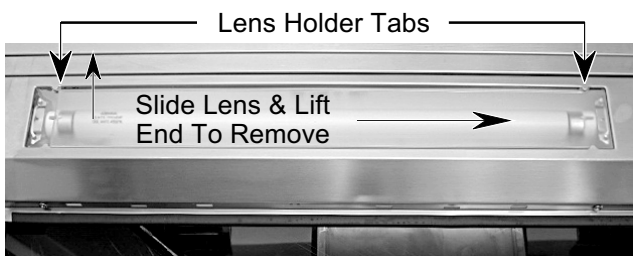

5. Remove the fluorescent lamp from the sockets.

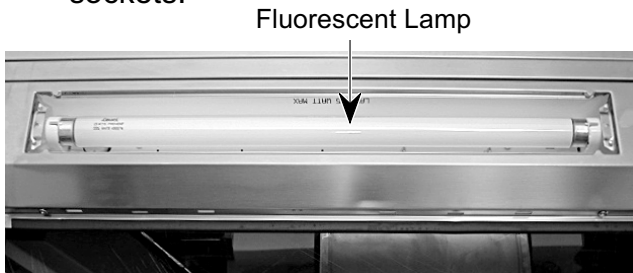

6. Remove the two screws from the fluorescent lamp holder and remove the holder.



7. Remove the wire nut from one of the ballast transformer wires and untwist the wire ends.
8. Remove the plastic tubing from the transformer wires and cut the second transformer wire near the case.
9. Remove the two screws from the transformer and remove the transformer.

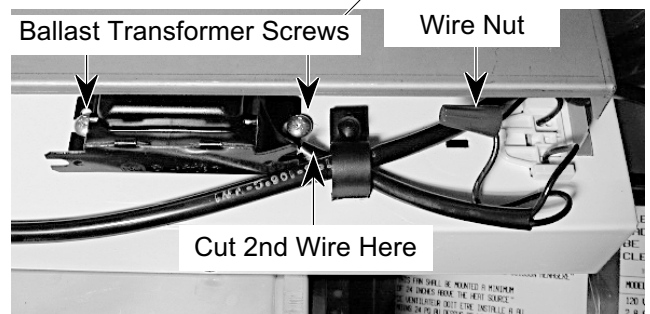
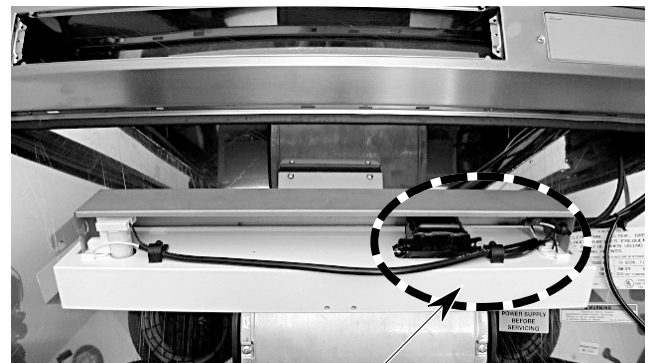

REASSEMBLY NOTE: You will have to splice the cut ballast transformer wire, (going to the fluorescent lamp socket), to either of the two wires coming from the new transformer, and secure the ends with a wire nut. Cut the wires to the appropriate length, as necessary.

REMOVING THE CONTROL BOARD

! WARNING

ELECTRICAL SHOCK HAZARD

**Disconnect power before servicing.
Replace all panels before operating.
Failure to do so could result in death or
electrical shock.**

NOTE: Sharp edges may be present.

1. Disconnect the electrical power to the hood.
2. Remove the three filters from the hood.
3. Remove the two screws from the control assembly and pull the assembly around through the filter section to the front.

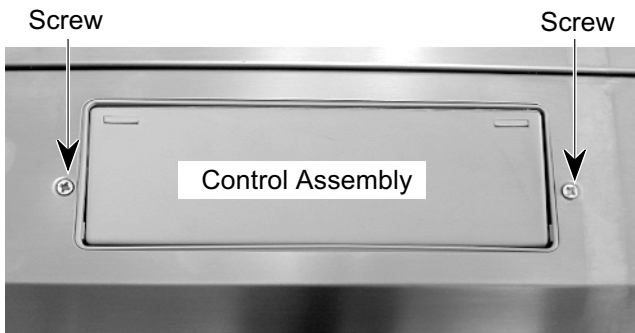

4. Pull the two pivot pins out of the ends of the control assembly.
5. Remove the two screws from the cable clamp and remove the clamp.

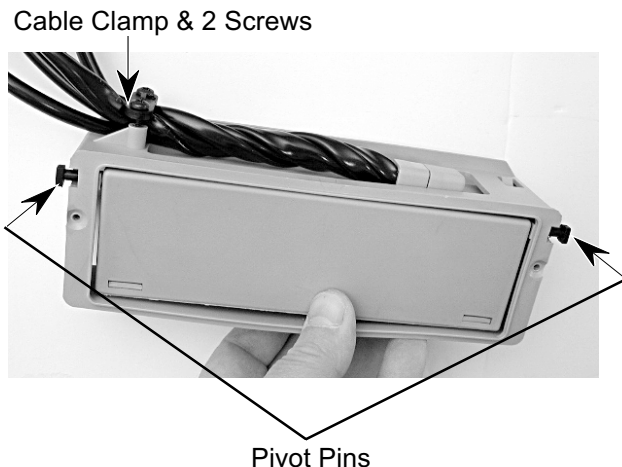

6. Slide the control housing out of the plastic frame and remove the plastic pin, spring, and housing from the frame.

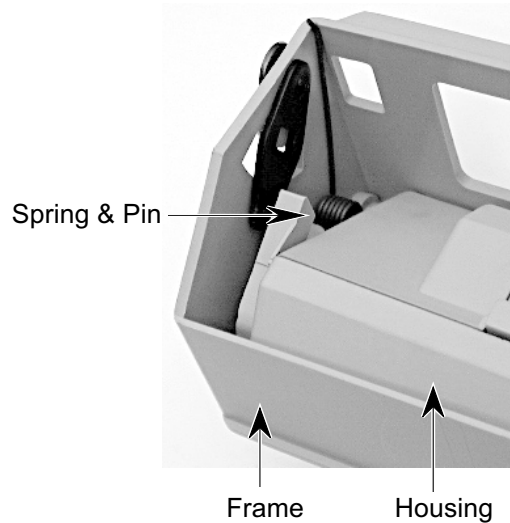

7. Remove the housing screw from the control assembly.

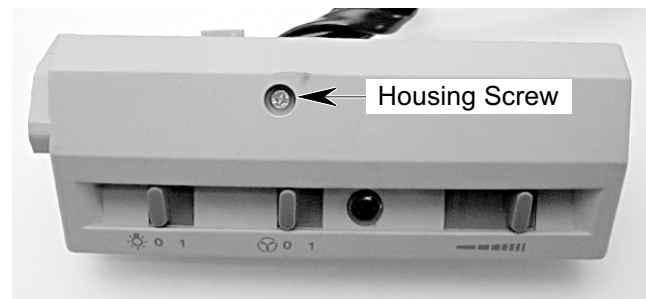

8. Separate the two sections by rotating the slide switch section away from the housing and unsnapping the two tabs from their slots.

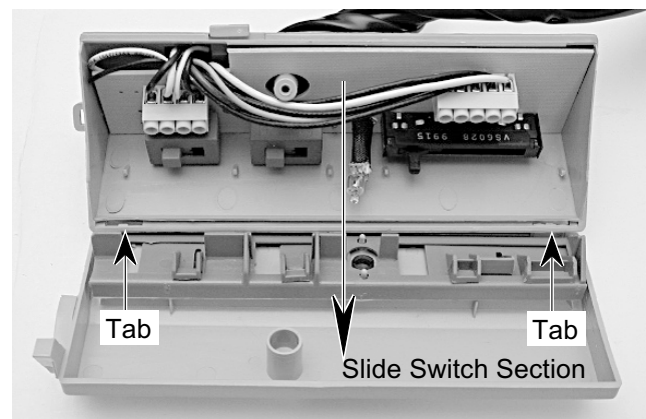

9. Remove the wires from the screw terminals on the two terminal blocks, and remove the control board from the housing. **NOTE:** Make sure to connect the wires to the same terminal locations on the new board (see the wiring illustration).

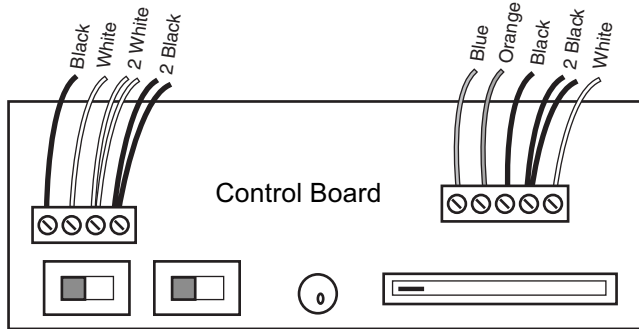
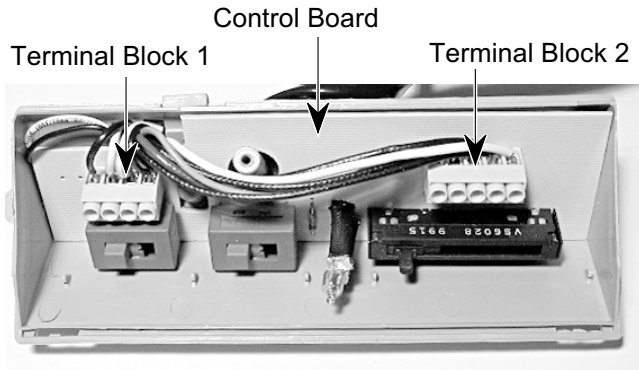

REASSEMBLY NOTES:

- Before you reassemble the control assembly, make sure that the slide switches operate properly, and that the indicator light is in line with the red lens, before securing the housing sections.
- Install the spring in the control assembly as shown below. Keep the short end of the spring on top of the boss (molded on the side of the switch panel). Also keep the long end of the spring against the inside of the frame, and the pin in the grooved track.

Keep Long End Of Spring Against Inside Of Frame

Position Pin In Track Here

Place Short End Of Spring On Top Of Boss Here

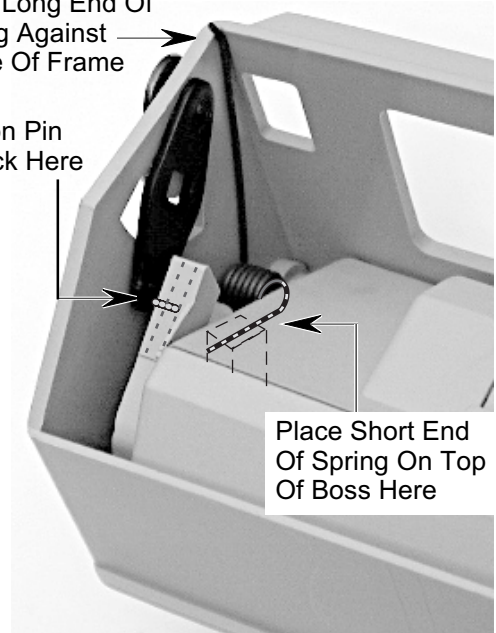

REMOVING THE BLOWER MOTOR

! WARNING

ELECTRICAL SHOCK HAZARD

**Disconnect power before servicing.
Replace all panels before operating.
Failure to do so could result in death or electrical shock.**

NOTE: Sharp edges may be present.

1. Disconnect the electrical power to the hood.
2. Remove the three filters from the hood.
3. Remove the control assembly and disconnect the wires from the control board terminal block screws (see pages 2-8 & 2-9 for the procedure).
4. Remove the two screws from each side of the blower motor mounting bracket, and remove the blower motor from the hood.

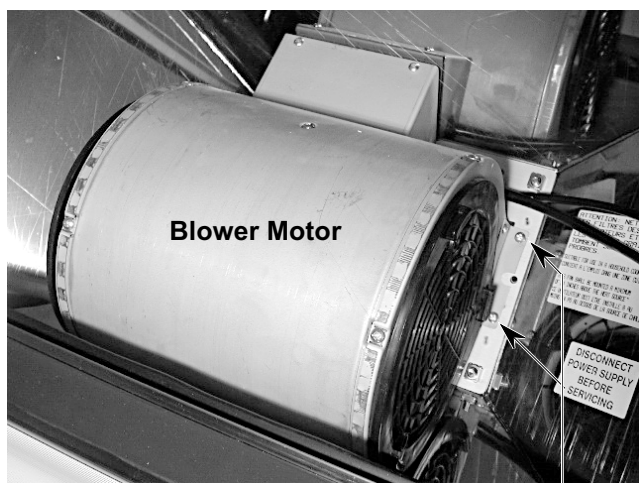

Blower Motor Screws (2 On Each Side)



5. Position the blower motor on a work surface on one of its sides.
6. Remove the five screws from the blower motor housing side cover that is facing up and remove the cover. NOTE: Do not remove the plastic grille from the cover.



7. Remove the four motor bracket mounting screws from the center of the motor housing, and pull the motor and bracket out of the housing.

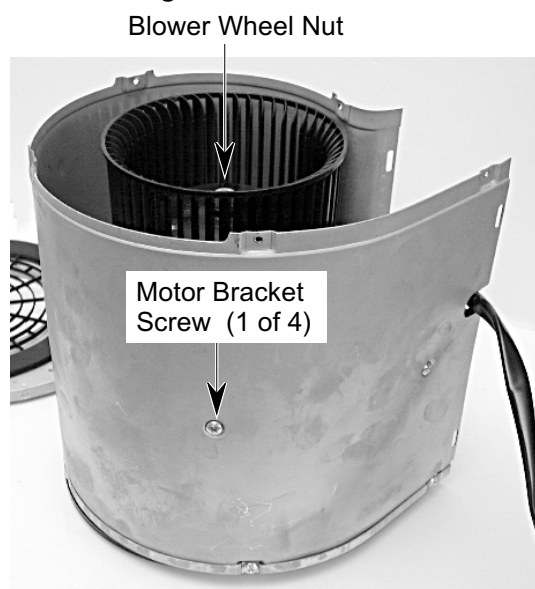

8. Remove the mounting nut from each of the blower wheels and remove the wheels from the blower motor.

COMPONENT TESTING

Before testing any of the components, perform the following checks:

- The most common cause for control failure is corrosion on connectors. Therefore, disconnecting and reconnecting wires will be necessary throughout test procedures.
- All tests/checks should be made with a VOM or DVM having a sensitivity of 20,000 ohms-per-volt DC, or greater.
- Check all connections before replacing components, looking for broken or loose wires, failed terminals, or wires not pressed into connectors far enough.
- Voltage checks must be made with all connectors attached to the boards.
- Resistance checks must be made with power cord unplugged from outlet, and with wiring harness or connectors disconnected.

! WARNING

ELECTRICAL SHOCK HAZARD

Disconnect power before servicing.

Replace all panels before operating.

Failure to do so could result in death or electrical shock.

BLOWER MOTOR



Refer to page 2-2 (wall hoods), or 2-10 (island hoods), for the procedure for accessing the blower motor.

1. Disconnect the electrical power to the hood.
2. Disconnect the wires from the blower motor terminals.
3. Set the ohmmeter to the R x 1 scale.
4. Touch the ohmmeter leads to the blue and white motor wires. The meter should indicate between 15 and 35 Ω .

BALLAST TRANSFORMER (ISLAND HOODS ONLY)



Refer to page 2-7 (island hoods), for the procedure for accessing the ballast transformer.

1. Disconnect the electrical power to the hood.
2. Set the ohmmeter to the R x 1 scale.
3. Touch the ohmmeter leads to the ballast transformer wire ends at the wire nut and the fluorescent lamp socket. The meter should indicate between 18 and 28 Ω .

! WARNING

ELECTRICAL SHOCK HAZARD

Disconnect power before servicing.
Replace all panels before operating.
Failure to do so could result in death or electrical shock.

2- & 3-POSITION SLIDE SWITCHES

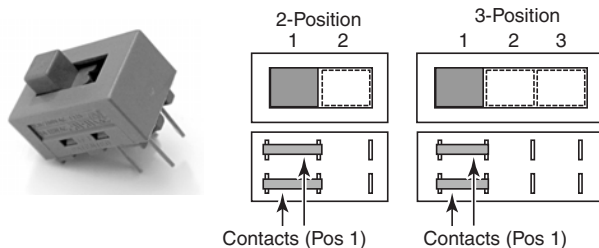

Refer to page 2-2 (wall hoods), or 2-8 (island hoods), for the procedure for accessing the slide switches.

NOTE: The island hood slide switches are soldered to the control board and have to be tested on the board. The wall hood slide switches have wire connectors that can be removed for testing.

1. Disconnect the electrical power to the hood.
2. Disconnect the wires from the switch terminals (wall hoods).
3. Set the ohmmeter to the R x 1 scale.
4. Refer to the illustration above, and touch the ohmmeter test leads to the switch pins that have the slider in the “contact” position (1). The meter should indicate a closed (0 Ω) circuit.
5. With the meter leads at the same pin locations and the slider in another position, the meter should indicate an open (infinite) circuit.

NOTE: If the readings do not indicate as specified, replace the switch (wall hoods) or the control board (island hoods).

SPEED (VARIABLE) CONTROL (ISLAND HOODS ONLY)

Touch Leads To These Two Screws
(With Blue & Orange Wires)

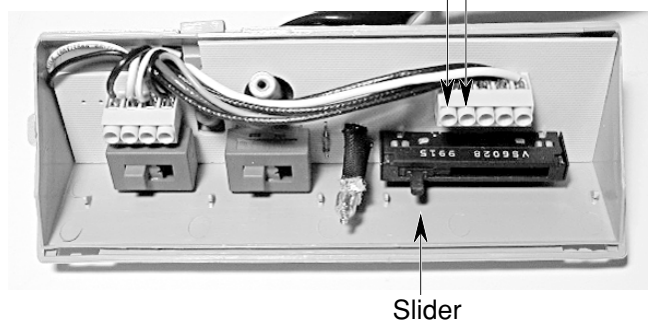

Refer to page 2-8 (island hoods), for the procedure for accessing the control board.

NOTE: The island hood speed control is soldered to the control board and can be tested on the board.

1. Disconnect the electrical power to the hood.
2. Set the ohmmeter to the R x 10K scale.
3. Position the speed control slider all the way to the left (see above).
4. Touch the ohmmeter test leads to the two indicated terminal screws (with the orange and blue wires). The meter should indicate approximately 260K Ω .
5. Leave the leads touching the two terminal screws, and slowly push the slider all the way to the right. The meter resistance should gradually change from 260 K Ω to 0 Ω .

NOTE: If the readings do not indicate within 20% of those specified, replace the control board.

WIRING DIAGRAMS

ISLAND HOOD

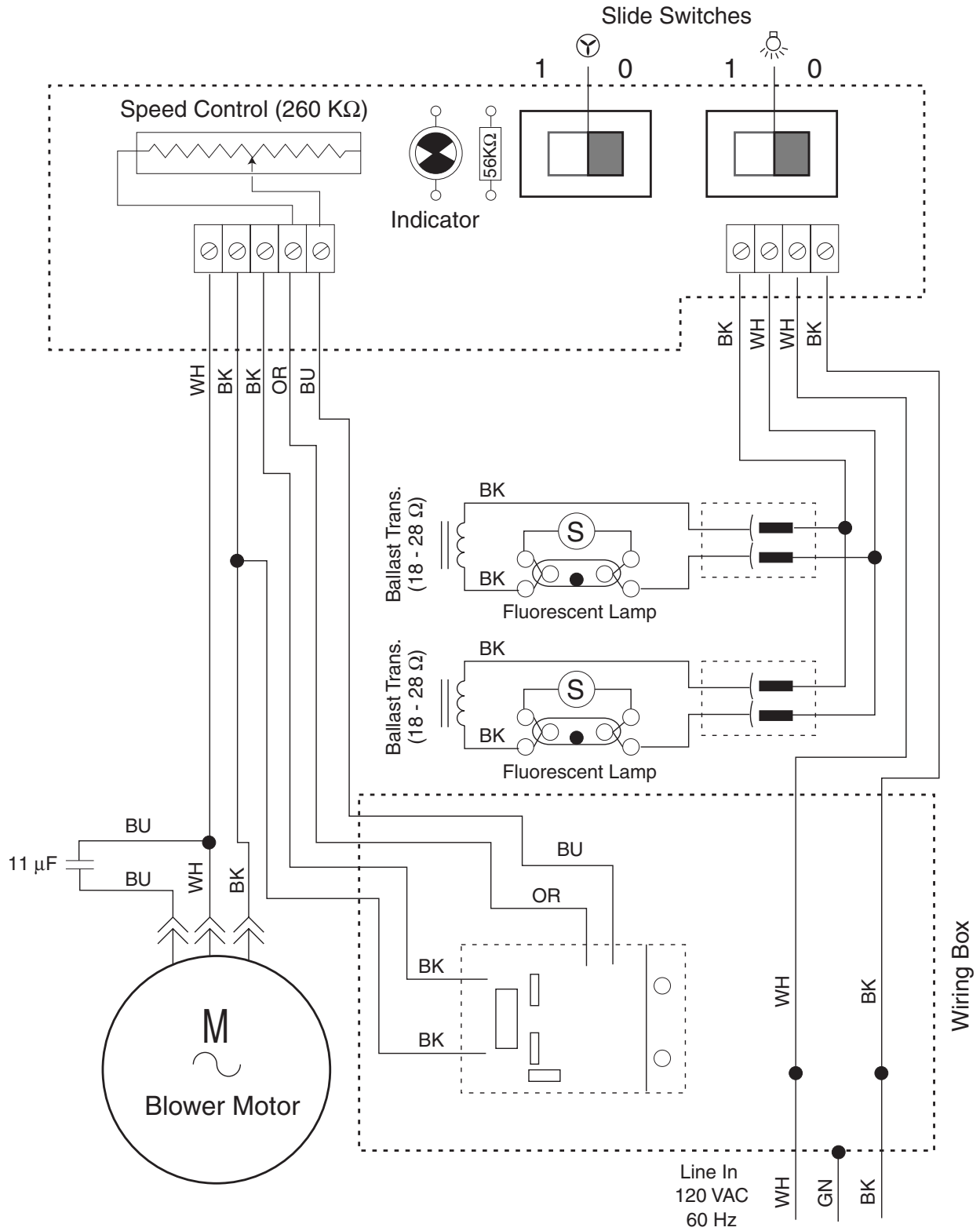

PRODUCT SPECIFICATIONS AND WARRANTY INFORMATION SOURCES

IN THE UNITED STATES:

FOR PRODUCT SPECIFICATIONS AND WARRANTY INFORMATION CALL:

FOR WHIRLPOOL PRODUCTS: 1-800-253-1301
FOR KITCHENAID PRODUCTS: 1-800-422-1230
FOR ROPER PRODUCTS: 1-800-447-6737

FOR TECHNICAL ASSISTANCE WHILE AT THE CUSTOMER'S HOME CALL:

THE TECHNICAL ASSISTANCE LINE: 1-800-253-2870

**HAVE YOUR STORE NUMBER READY TO IDENTIFY YOU AS AN
AUTHORIZED SERVICER**

FOR LITERATURE ORDERS:

PHONE: 1-800-851-4605

IN CANADA:

FOR PRODUCT SPECIFICATIONS AND WARRANTY INFORMATION CALL:

1-800-461-5681

FOR TECHNICAL ASSISTANCE WHILE AT THE CUSTOMER'S HOME CALL:

THE TECHNICAL ASSISTANCE LINE: 1-800-488-4791

**HAVE YOUR STORE NUMBER READY TO IDENTIFY YOU AS AN
AUTHORIZED SERVICER**

KitchenAid®
FOR THE WAY IT'S MADE.®

