

KitchenAid

TECHNICAL EDUCATION

SELF-CLEANING SLIDE-IN GAS RANGE



Models: KGST300, KGST307, KGRT600,
KGRT607, YKGST307, YKGRT607

JOB AID 4317337

FORWARD

This KitchenAid Job Aid, “Self-Cleaning Slide-In Gas Range,” (Part No. 4317337), provides the technician with information on the installation, operation, and service of the Self-Cleaning Slide-In Gas Range. It is to be used as a training Job Aid and Service Manual. For specific information on the model being serviced, refer to the “Use and Care Guide,” or “Wiring Diagram” provided with the gas range.

The Wiring Diagram and Strip Circuits used in this Job Aid are typical and should be used for training purposes only. Always use the Wiring Diagram supplied with the product when servicing the unit.

GOALS AND OBJECTIVES

The goal of this Job Aid is to provide detailed information that will enable the service technician to properly diagnose malfunctions and repair the KitchenAid Self-Cleaning Slide-In Gas Range.

The objectives of this Job Aid are to:

- Understand and follow proper safety precautions.
- Successfully troubleshoot and diagnose malfunctions.
- Successfully perform necessary repairs.
- Successfully return the range to its proper operational status.

WHIRLPOOL CORPORATION assumes no responsibility for any repairs made on our products by anyone other than Authorized Service Technicians.

TABLE OF CONTENTS

Page

GENERAL	1-1
Safety First.....	1-1
KitchenAid Model & Serial Number Designations.....	1-3
Model & Serial Number Label & Wiring Diagram Locations.....	1-4
Specifications.....	1-5
KitchenAid Gas Range Warranty.....	1-9
INSTALLATION INFORMATION	2-1
Gas Supply Requirements.....	2-1
Electrical Requirements.....	2-3
L.P. Gas Conversion.....	2-4
Adjusting For The Proper Flame.....	2-8
Installing The Anti-Tip Bracket.....	2-9
THEORY OF OPERATION	3-1
Electronic Ignition System.....	3-1
Air Flow—Rear Panel.....	3-2
Cooling Fan Air Flow.....	3-3
The Bimetal Switches.....	3-4
The Door Lock Solenoid & Door Latch Switch.....	3-5
How The Self-Clean Cycle Works.....	3-6
COMPONENT ACCESS	4-1
Component Locations.....	4-1
Removing The Control Panel, Ignition Switches, A Gas Valve, And A Bimetal Switch.....	4-2
Removing The Door Latch Assembly.....	4-5
Removing The Electronic Oven Control Board And The Touch/Control Panel Assembly.....	4-6
Removing The Cooktop Bimetal & A Surface Burner/Ignitor.....	4-8
Removing The Cooktop Glass & Vent.....	4-10
Removing The Convection Fan Motor.....	4-12
Removing An Oven Light Socket Assembly.....	4-14
Removing The Meat Probe Jack.....	4-15
Removing The Broil Burner & Ignitor.....	4-16
Removing The Bake Burner & Ignitor.....	4-18
Removing The Oven Temperature Sensor.....	4-20
Removing The Gas Distribution And Safety Valves.....	4-21
Removing A Side Panel.....	4-22
Removing The Door Switch & Power Supply Board.....	4-23
Removing The Spark Module And The Cooling Fan Motor.....	4-24
Removing The Decorative Glass, The Oven Door Handle, The Hinges, And The Oven Door Glass.....	4-26
Removing The Oven Door.....	4-28
Removing The Oven Door Gasket.....	4-29

	Page
COMPONENT TESTING	5-1
Bimetal Switches	5-1
Ignition Switches	5-2
Door Switch	5-3
Door Latch Assembly	5-3
Convection Fan Motor	5-4
Safety Valve	5-4
Gas Distribution Valve	5-5
Oven Temperature Sensor	5-5
Cooling Fan Motor	5-6
Broil & Bake Ignitors	5-6
Gas Valve	5-7
DIAGNOSIS & TROUBLESHOOTING	6-1
Diagnosis	6-1
Failure/Error Display Codes	6-1
Fault Error Code Charts	6-2
Troubleshooting Chart	6-3
End Of Service Test Sequence	6-5
Oven Temperature Calibration	6-6
WIRING DIAGRAM & STRIP CIRCUITS	7-1
Wiring Diagram	7-1
Strip Circuits	7-2

GENERAL SAFETY FIRST

Your safety and the safety of others is very important.

We have provided many important safety messages in this Job Aid and on the appliance. Always read and obey all safety messages.



This is the safety alert symbol.

This symbol alerts you to hazards that can kill or hurt you and others.

All safety messages will follow the safety alert symbol and either the word "DANGER" or "WARNING." These words mean:

! DANGER

You can be killed or seriously injured if you don't immediately follow instructions.

! WARNING

You can be killed or seriously injured if you don't follow instructions.

All safety messages will tell you what the potential hazard is, tell you how to reduce the chance of injury, and tell you what can happen if the instructions are not followed.

! WARNING



Electrical Shock Hazard

Disconnect power before servicing.

Replace all parts and panels before operating.

Failure to do so can result in death or electrical shock.

! WARNING



Electrical Shock Hazard

Plug into a grounded 3-prong outlet.

Do not remove ground prong.

Do not use an adapter.

Do not use an extension cord.

Failure to follow these instructions can result in death, fire, or electrical shock.

⚠️ WARNING



Electrical Shock Hazard

Electrically ground range.

Failure to do so can result in death, fire, or electrical shock.

⚠️ WARNING



Tip-Over Hazard

A child or adult can tip the range and be killed.

Connect anti-tip bracket to rear range foot.

Reconnect the anti-tip bracket, if the range is moved.

Failure to follow these instructions can result in death or serious burns to children and adults.

⚠️ WARNING



Fire Hazard

Shut off gas supply line valve before servicing.

Check all gas line connections and replace all parts and panels before operating.

Failure to do so can result in explosion, fire or other injury.

IMPORTANT

Electrostatic Discharge (ESD) Sensitive Electronics

ESD problems are present everywhere. ESD may damage or weaken the electronic control assembly. The new control assembly may appear to work well after repair is finished, but failure may occur at a later date due to ESD stress.

- Use an antistatic wrist strap. Connect the wrist strap to the green ground connection point, or to an unpainted metal surface in the appliance.

- OR -

- Touch your finger repeatedly to a green ground connection point, or to an unpainted metal surface in the appliance.
- Before removing the part from its package, touch the antistatic bag to a green ground connection point, or to an unpainted metal surface in the appliance.
- Avoid touching electronic parts, or terminal contacts. Handle the electronic control assembly by the edges only.
- When repackaging the failed electronic control assembly in an antistatic bag, observe the previous instructions.

KITCHENAID MODEL & SERIAL NUMBER DESIGNATIONS

MODEL NUMBER

MODEL NUMBER	K	GS	T	30	7	H	WH	8
INTERNATIONAL SALES IND. OR MARKETING CHANNEL IF PRESENT								
PRODUCT GROUP								
K = KITCHENAID								
PRODUCT IDENTIFICATION								
DD = DUAL FUEL DROP-IN / SLIDE-IN								
DR = DUAL FUEL RANGE								
ED = ELECTRIC DROP-IN RANGE								
EE = ELECTRIC EYE-LEVEL RANGE								
ER = ELECTRIC STANDARD RANGE								
ES = ELECTRIC SLIDE-IN RANGE								
GD = GAS DROP-IN RANGE								
GE = GAS EYE-LEVEL RANGE								
GR = GAS STANDARD RANGE								
GS = GAS SLIDE-IN RANGE								
MERCHANDISING SCHEME								
C = CERAMIC GLASS TOP								
H = CERAMIC W/HALOGEN								
I = IMPERIAL								
P = PROFESSIONAL / COMMERCIAL								
S = STANDARD								
T = TEMPERED GLASS TOP								
CAPACITY / SIZE / SERIES / CONFIGURATION								
1ST POSITION								
1 = DROP-IN								
2 = DROP-IN / SLIDE-IN COMBO								
3 = SLIDE-IN								
4 = COMMERCIAL								
5 = STANDARD								
7 = EYE-LEVEL								
8 = 48"								
9 = 60"								
2ND POSITION								
0 = 30" WIDE								
6 = 36" WIDE								
FEATURES								
0 = STANDARD FEATURES								
2 = PLUS FEATURES OR SEALED BURNERS W / GRILL / CONVECTION OVEN								
3 = SEALED BURNERS W / GRIDDLE / CONVECTION OVEN								
4 = SEALED BURNERS W / GRILL & GRIDDLE / CONVECTION OVEN								
5 = DELUXE FEATURES								
7 = DELUXE FEATURES / CONVECTION OR SEALED BURNERS / CONVECTION OVEN								
YEAR OF INTRODUCTION								
H = 1999, J = 2000, K = 2001, L = 2002								
COLOR CODE								
BL = BLACK, WH = WHITE, BT = BISCUIT								
BS = BLACK ON STAINLESS, AL = ALMOND								
ENGINEERING CHANGE (NUMERIC)								

SERIAL NUMBER

SERIAL NUMBER	IM	M	20	77981
MANUFACTURING SITE				
IM = MONTMAGNY				
YEAR OF PRODUCTION				
M = 2002				
WEEK OF PRODUCTION				
20 = 20TH WEEK				
PRODUCT SEQUENCE NUMBER				

MODEL & SERIAL NUMBER LABEL & WIRING DIAGRAM LOCATIONS

The Model/Serial Number label and Wiring Diagram locations are shown below.

Model & Serial Number Location (Located Behind Storage Drawer)



Wiring Diagram (Located On Rear Panel)

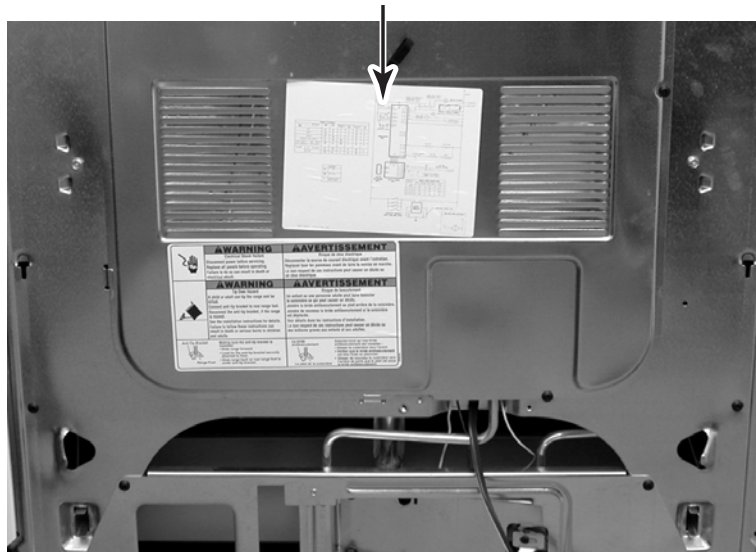

SPECIFICATIONS

Model Number	KGRT600H WH, AL	KGRT607H WH, BL, BT, BS
Dimensions/Specifications		
Overall Height (in)	44 3/8"	44 3/8"
Height To Maintop (in)	36 1/4"	36 1/4"
Overall Width (in)	30"	30"
Overall Depth Inc Hrdwr/Hndl (in)	27 3/4"	27 3/4"
Depth To Manifold Panel (in)	25"	25"
Depth Without Handle (in)	25 1/2"	25 1/2"
Door Swing (in)	21 3/4"	21 3/4"
Shipping Weight (lbs)	185	185
Control Panel		
Control Panel Location	Front	Front
Control Knob Type, #, Fcn	Glass Capacitive	Glass Capacitive
Cooktop Material	Ceramic Glass	Ceramic Glass
Hot Surface Indicator	4 Neon Cluster	4 Neon Cluster
Burner Box Finish	Galvanized	Galvanized
Burner Grate Material	Cast Iron	Cast Iron
Gas Cooktop Burners	Yes	Yes
Gas Burner Configuration		
Gas Burner Type	Sealed	Sealed
Gas Right Front Output (BTU)(Nat/LP)	6000 BTU	6000 BTU
Gas Left Front Output (BTU)(Nat/LP)	14000 BTU	14000 BTU
Gas Right Rear Output (BTU)(Nat/LP)	12500 BTU	12500 BTU
Gas Left Rear Output (BTU)(Nat/LP)	6000 BTU	6000 BTU
Gas Burner Cap Type	Cast Iron	Cast Iron
Gas Ignition Cooktop	Electronic	Electronic
Gas Valves Degrees	210 degress	210 degress
Convection	No	3rd Element
Convection Bake	No	Yes
Convection Broil	No	Yes
Convection Roast	No	Yes
Easy Convection Baked Goods	No	Yes
Control Lock Out	Yes	Yes
Delayed Cooking Option	Yes	Yes
Full Meal Cook	No	Yes
Temperature Probe	Yes	Yes
Timer	In EOC	In EOC

Model Number	KGRT600H WH, AL	KGRT607H WH, BL, BT, BS
Interior		
Main Oven		
Cooking System	Conventional	Fan Convection
Cleaning System	Self Cleaning	Self Cleaning
Auto Self Clean Latch	Yes	Yes
Oven Liner Finish	Porcelain	Porcelain
Oven Dimensions		
Oven Volume (cu ft)	3.62 cu ft	3.28 cu ft
Oven Height (in)	15.75"	15.75"
Oven Width (in)	23 1/16"	23 1/16"
Oven Depth (in)	18 .25"	16 5/16"
Rack Guides #	5	5
Oven Racks #	2	3
Oven Rack Type & # Each	2 Flat	3 Flat
Oven Rack	Yes	Yes
Broiler Pan	Yes	Yes
Broiler Pan Finish	Porcelain	Porcelain
Broiler Pan Grid Finish	Porcelain	Porcelain
Roasting Rack	Yes	Yes
Oven Light Number	1-Incandescent	2-Incandescent
Main Gas Oven		
Oven Ignition Type	Electronic	Electronic
Gas Broiler Type	Blanket of Flame	Blanket of Flame
Gas Bake Output (BTU) (Nat/LP)	15000 BTU	15000 BTU
Gas Broil Output (BTU) (Nat/LP)	9000 BTU	9000 BTU
Oven Lower Panel/ Door	Yes	Yes
Lower Storage Drawer	Yes	Yes
Drawer/Panel Front	Painted	Painted
Drawer/Panel Color	White	White
Storage Drawer Liner	Yes	Yes
Drawer/Panel Dimensions		
Drawer/Panel Height (in)	5.1"	5.1"
Drawer/Panel Width (in)	23.3"	23.3"
Drawer/Panel Depth (in)	20"	20"
Glides	Nylon Rollers	Nylon Rollers
Accessories		
LP Conversion Kit	Included	Included
LP Conversion Kit Part/Comment	Spud	Spud
Miscellaneous		
Product Literature		
Job Aid Manual	4317337	4317337
Installation Instructions	Yes	Yes
Tech Sheet	9754241	9754241
Use & Care Guide	9754288	9754288

Model Number	KGST300H WH, BT	KGST307H WH, BL, BT, BS
Dimensions/Specifications		
Overall Height (in)	44 3/8"	44 3/8"
Height To Maintop (in)	36 1/4"	36 1/4"
Overall Width (in)	30"	30"
Overall Depth Inc Hrdwr/Hndl (in)	27 3/4"	27 3/4"
Depth To Manifold Panel (in)	25"	25"
Depth Without Handle (in)	25 1/2"	25 1/2"
Door Swing (in)	21 3/4"	21 3/4"
Shipping Weight (lbs)	180	180
Control Panel		
Control Panel Location	Front	Front
Control Knob Type, #, Fcn	Glass Capacitive	Glass Capacitive
Cooktop Material	Ceramic Glass	Ceramic Glass
Hot Surface Indicator	4 Neon Cluster	4 Neon Cluster
Burner Box Finish	Galvanized	Galvanized
Burner Grate Material	Cast Iron	Cast Iron
Gas Cooktop Burners	Yes	Yes
Gas Burner Configuration		
Gas Burner Type	Sealed	Sealed
Gas Right Front Output (BTU)(Nat/LP)	6000 BTU	6000 BTU
Gas Left Front Output (BTU)(Nat/LP)	14000 BTU	14000 BTU
Gas Right Rear Output (BTU)(Nat/LP)	12500 BTU	12500 BTU
Gas Left Rear Output (BTU)(Nat/LP)	6000 BTU	6000 BTU
Gas Burner Cap Type	Cast Iron	Cast Iron
Gas Ignition Cooktop	Electronic	Electronic
Gas Valves Degrees	210 degress	210 degress
Convection	No	3rd Element
Convection Bake	No	Yes
Convection Broil	No	Yes
Convection Roast	No	Yes
Easy Convection Baked Goods	No	Yes
Control Lock Out	Yes	Yes
Delayed Cooking Option	Yes	Yes
Full Meal Cook	No	No
Timer	In EOC	In EOC

Model Number	KGST300H WH, BT	KGST307H WH, BL, BT, BS
Interior		
Main Oven		
Cooking System	Conventional	Fan Convection
Cleaning System	Self Cleaning	Self Cleaning
Auto Self Clean Latch	Yes	Yes
Oven Liner Finish	Porcelain	Porcelain
Oven Volume (cu ft)	3.62 cu ft	3.28 cu. ft.
Oven Height (in)	15.75"	15.75"
Oven Width (in)	23 1/16"	23 1/16"
Oven Depth (in)	18 .25"	16 5/16"
Rack Guides #	5	5
Oven Racks #	2	2
Oven Rack Type & # Each	2 Flat	2 Flat
Oven Rack	Yes	Yes
Broiler Pan	Yes	Yes
Broiler Pan Finish	Porcelain	Porcelain
Broiler Pan Grid Finish	Porcelain	Porcelain
Roasting Rack	Yes	Yes
Oven Light Number	1-Incandescent	1-Incandescent
Main Gas Oven	Yes	Yes
Oven Ignition Type	Electronic	Electronic
Gas Broiler Type	Blanket Of Flame	Blanket Of Flame
Gas Bake Output (BTU) (Nat/LP)	15000 BTU	15000 BTU
Gas Broil Output (BTU) (Nat/LP)	9000 BTU	9000 BTU
Oven Lower Panel/ Door	Yes	Yes
Lower Storage Drawer	Yes	Yes
Drawer/Panel Front	Painted	Painted
Drawer/Panel Color	White	White
Storage Drawer Liner	Yes	Yes
Drawer/Panel Dimensions		
Drawer/Panel Height (in)	5.1"	5.1"
Drawer/Panel Width (in)	23.3"	23.3"
Drawer/Panel Depth (in)	20"	20"
Glides	Nylon Rollers	Nylon Rollers
Accessories		
LP Conversion Kit	Included	Included
LP Conversion Kit Part/Comment	Spud	Spud
Miscellaneous		
Product Literature		
Job Aid Manual	4317337	4317337
Installation Instructions	Yes	Yes
Tech Sheet	9754241	9754241
Use & Care Guide	9754288	9754288

KITCHENAID GAS RANGE WARRANTY

LENGTH OF WARRANTY	KITCHENAID WILL PAY FOR:
FULL ONE YEAR WARRANTY From Date of Purchase.	Replacement parts and repair labor costs to correct defects in materials or workmanship. Service must be provided by a KitchenAid designated service company.
SECOND THROUGH FIFTH YEAR LIMITED WARRANTY From Date of Purchase.	<p>On ceramic glass ranges and ceramic glass cooktops, when this appliance is operated and maintained according to instructions attached to or furnished with the product, KitchenAid will pay for factory-specified parts and repair labor for the ceramic glass cooktop. KitchenAid warrants that the ceramic glass cooktop will not discolor, the cooktop pattern will not wear off, the rubber seal between the ceramic glass cooktop and porcelain edge will not crack, and the ceramic glass cooktop will not crack due to thermal shock.</p> <p>On gas ranges and gas cooktops, KitchenAid will pay for factory-specified parts and repair labor for any gas burner to correct defects in materials or workmanship. Service must be provided by a KitchenAid-designated service company.</p>
<p>KITCHENAID WILL NOT PAY FOR:</p> <p>A. Service calls to:</p> <ol style="list-style-type: none"> 1. Correct the installation of the range. 2. Instruct you how to use the range. 3. Replace house fuses or correct house wiring. <p>B. Repairs when range is used in other than normal, single family household use.</p> <p>C. Damage resulting from accident, alteration, misuse, abuse, fire, flood, acts of God, improper installation, or installation not in accordance with local electrical codes.</p> <p>D. Any labor costs during the limited warranties.</p> <p>E. Replacement parts or repair labor costs for units operated outside the United States and Canada.</p> <p>F. Pickup and delivery. Your range is designed to be repaired in the home.</p> <p>G. Repairs to ceramic glass cooktop if it has not been cared for as recommended in the Use and Care Guide.</p> <p>H. Repairs to parts or systems resulting from unauthorized modifications made to the appliance.</p> <p>I. In Canada, travel or transportation expenses to customers who reside in remote areas.</p>	

KITCHENAID OR KITCHENAID CANADA DO NOT ASSUME ANY RESPONSIBILITY FOR INCIDENTAL OR CONSEQUENTIAL DAMAGES. Some states or provinces do not allow the exclusion or limitation of incidental or consequential damages, so this exclusion or limitation may not apply to you. This warranty gives you special legal rights, and you may also have other rights which vary from state-to-state or province-to-province.

Outside the United States and Canada, a different warranty may apply. For details, please contact your authorized KitchenAid dealer.

If you need service first see the "Troubleshooting" section of the Use and Care Guide. After checking "Troubleshooting," additional help can be found by checking the "Assistance or Service" section, or by calling our Customer Interaction Center telephone numbers, listed below, from anywhere in the U.S.A. or Canada.

KitchenAid: **1-800-422-1230**
 Canadian Residents call: **1-800-807-6777**

— NOTES —

INSTALLATION INFORMATION

GAS SUPPLY REQUIREMENTS

! WARNING



Explosion Hazard

Use a new AGA or CSA approved gas supply line.

Install a shutoff valve.

Securely tighten all gas connections.

If connected to L.P. gas, have a qualified person make sure gas pressure does not exceed 14" water column.

Examples of a qualified person include licensed heating personnel, authorized gas company personnel, and authorized service personnel.

Failure to do so can result in death, explosion, or fire.

Observe all governing codes and ordinances.

IMPORTANT: Range must be connected to a regulated gas supply.

1. This installation must conform with local codes and ordinances. In the absence of local codes, installations must conform with American National Standard, National Fuel Gas Code ANSI Z223.1—latest edition* or CANI-B149—latest edition** installation codes.

Copies of the standards listed may be obtained from:

* American Gas Association
1515 Wilson Boulevard
Arlington, Virginia 22209

** CSA International
8501 East Pleasant Valley Road
Cleveland, Ohio 44131-5575

2. Input ratings shown on the model/serial rating plate are for elevations up to 2,000 feet (609.6 m). For elevations above 2,000 feet (609.6 m), ratings are reduced at a rate of 4% for each 1,000 feet (304.8 m) above sea level. (Not applicable for Canada.)
3. This range is equipped for use with Natural gas. It is design-certified by AGA/CSA for Natural and L.P. gas with appropriate conversion. Conversion to L.P. gas can be made using the kit included in the literature package. The model/serial rating plate, located on the oven frame behind the storage drawer panel, has information on the type of gas that can be used. If this information does not agree with the type of gas available, check with your KitchenAid dealer.
4. Provide a gas supply line of 3/4" (1.9 cm) rigid pipe to the range location. A smaller size pipe on long runs may result in insufficient gas supply. Pipe-joint compounds appropriate for use with L.P. gas must be used. With L.P. gas, piping or tubing size can be 1/2" (1.3 cm) minimum. L.P. gas suppliers usually determine the size and materials used on the system.
5. If local codes permit, a new AGA/CSA design-certified, 4-5 foot (122 -152.4 cm) long, 1/2" (1.3 cm) or 3/4" (1.9 cm) I.D., flexible metal appliance connector is recommended for connecting this range to the gas supply line. Do Not kink or damage the flexible tubing when moving the range. A 1/2" (1.3 cm) male pipe thread is needed for connection to pressure regulator female pipe threads.

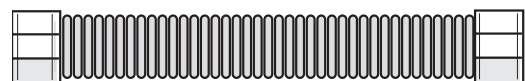

Flexible Gas Supply Line

- The supply line shall be equipped with an approved shutoff valve. This valve should be located in the same room, but external to the range, and should be in a location that allows ease of opening and closing. Do Not block access to shutoff valve.

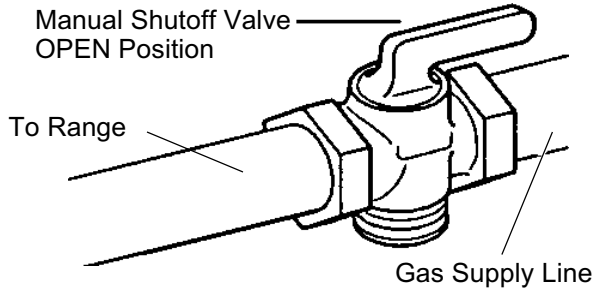

- If rigid pipe is used as a gas supply line, a combination of pipe fittings must be used to obtain an in-line connection to the range. All strains must be removed from the supply and fuel lines so the range will be level and in line.

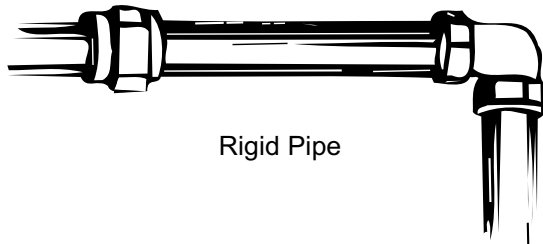

- The regulator setting must be checked at a minimum of 1 inch water column above the manifold pressure. The inlet pressure to the regulator should be as follows for operation:

Natural gas:

- Manifold pressure — 5 inches
- Maximum pressure — 14 inches

L.P. gas:

- Manifold pressure—10 inches
- Maximum pressure—14 inches

- Line pressure testing:**

Testing above 1/2 psi (gauge)

The range and its individual shutoff valve must be disconnected from the gas supply piping system during any pressure testing of that system at test pressures greater than 1/2 psig (3.5 kPa).

Testing at 1/2 psi (gauge) or lower

The range must be isolated from the gas supply piping system by closing its individual manual shutoff valve during any pressure testing of the gas supply piping system at test pressures equal to or less than 1/2 psig (3.5 kPa).

ELECTRICAL REQUIREMENTS

⚠ WARNING



Electrical Shock Hazard

Plug into a grounded 3-prong outlet.

Do not remove ground prong.

Do not use an adapter.

Failure to follow these instructions can result in death, fire, or electrical shock.

If codes permit and a separate ground wire is used, it is recommended that a qualified electrician determine that the ground path is adequate.

Do Not ground to a gas pipe.

Check with a qualified electrician if you are not sure range is grounded.

Do Not have a fuse in the neutral or ground circuit.

A 120-volt, 60-Hz, AC-only, 15-ampere, fused electrical circuit is required. A time-delay fuse or circuit breaker is recommended. It is recommended that a separate circuit serving only this range be provided.

Electronic ignition systems operate within wide voltage limits, but proper grounding and polarity are necessary. In addition to checking that the outlet provides 120-volt power and is correctly grounded, the outlet must be checked by a qualified electrician to see if it is wired with correct polarity.

The wiring diagram is included in the literature package. The wiring diagram can also be found on the back of the range.

Note: The metal chassis of the range **MUST** be grounded in order for the control panel to work. If the metal chassis of the range is not grounded, **NO** keypads will operate. Check with a qualified electrician if you are in doubt as to whether the metal chassis of range is grounded.

Recommended ground method

For personal safety, this range is equipped with a power supply cord having a 3-prong ground plug. To minimize possible shock hazard, the cord must be plugged into a mating 3-prong, ground-type outlet, grounded in accordance with the National Electrical Code, ANSI/NFPA 70—latest edition* or CSA Standard C22.1, Canadian Electrical Code, Part 1,—latest edition** and all local codes and ordinances. If a mating outlet is not available, it is the personal responsibility and obligation of the customer to have a properly grounded, 3-prong outlet installed by a qualified electrician.

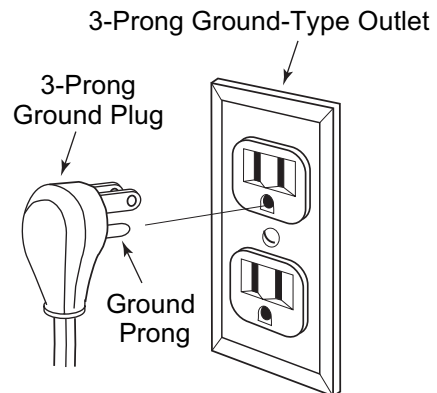

Copies of the standards listed may be obtained from:

* National Fire Protection Association
Batterymarch Park
Quincy, Massachusetts, 02269

** CSA International
8501 East Pleasant Valley Road
Cleveland, Ohio 44131-5575

L.P. GAS CONVERSION

⚠️ WARNING



Electrical Shock Hazard

Disconnect power before servicing.

Replace all parts and panels before operating.

Failure to do so can result in death or electrical shock.



Fire Hazard

Shut off gas supply line valve.

Make all conversions before turning gas supply valve back on.

Failure to follow these instructions can result in explosion, fire, or other injury.

NOTE: Gas conversion from Natural to L.P. gas must be done by a qualified installer. Examples of a qualified installer includes licensed heating personnel, authorized gas company personnel, and authorized service personnel.

L.P. gas must not be used unless the L.P. conversion has been made using the kit that is included with this range. See the "Gas Supply Requirements" starting on page 2-1.

1. Check to make sure that the main gas supply line to the range has been shut off, (see below), and that the power supply cord is disconnected from the AC outlet.

Gas Valve Handle To "Shutoff" Position

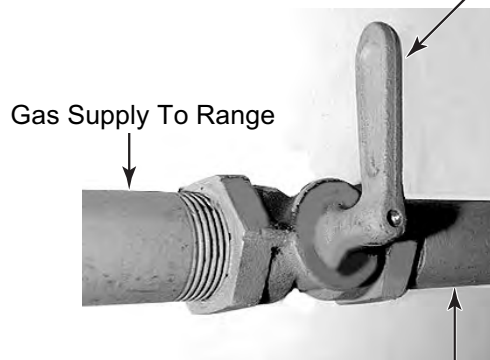

Gas Supply Line

2. **To convert the surface burners for use with L.P. gas:**

a) Remove the grates and burner caps.

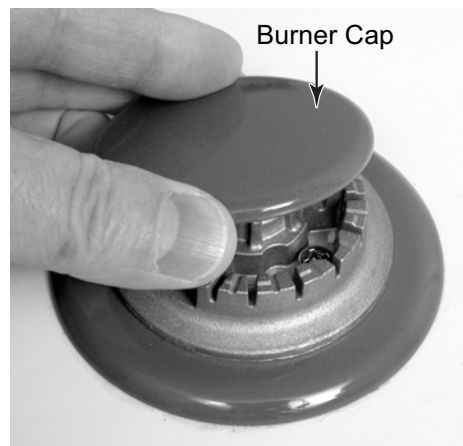
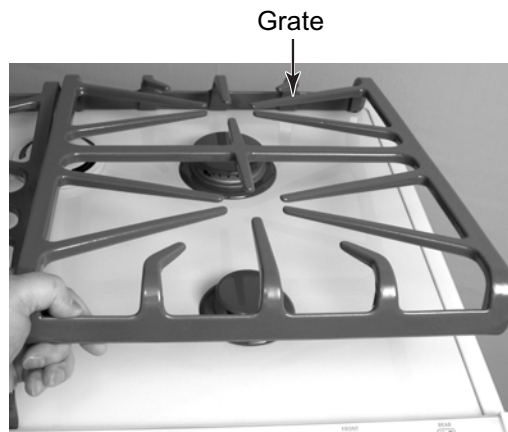

b) Remove the two screws from each of the burner heads and lift the heads off the cooktop.

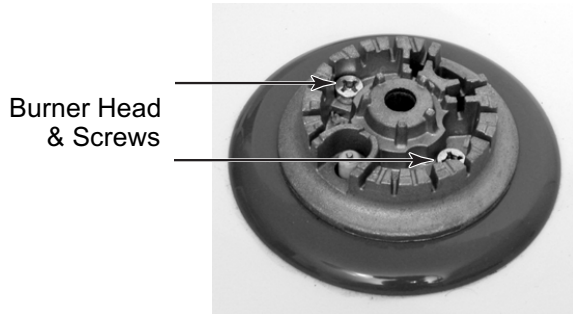

c) If there is a decorative cover installed around the burner, remove the screws, and remove the cover.

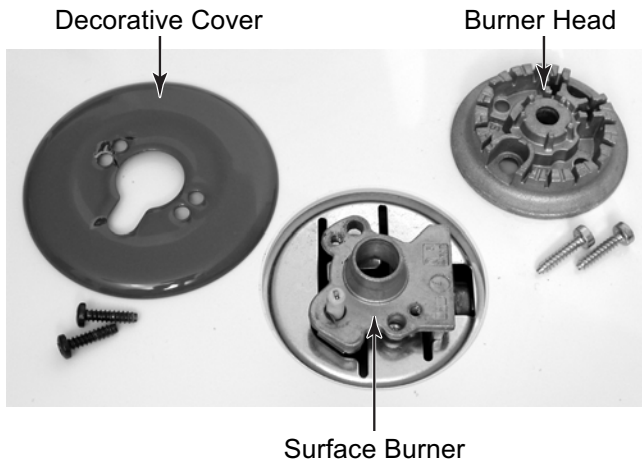
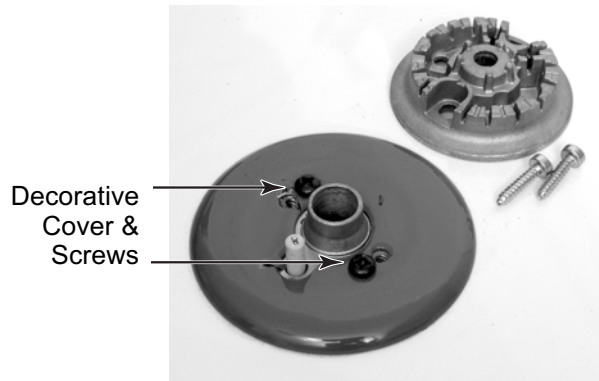

d) Use an 8 mm socket and carefully remove the orifice spud from each of the four burners.

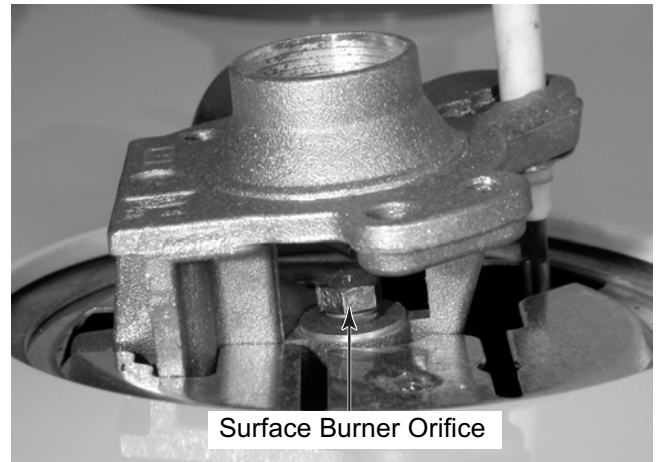

e) Remove the L.P. orifices from the small plastic bag (located inside the literature pack).

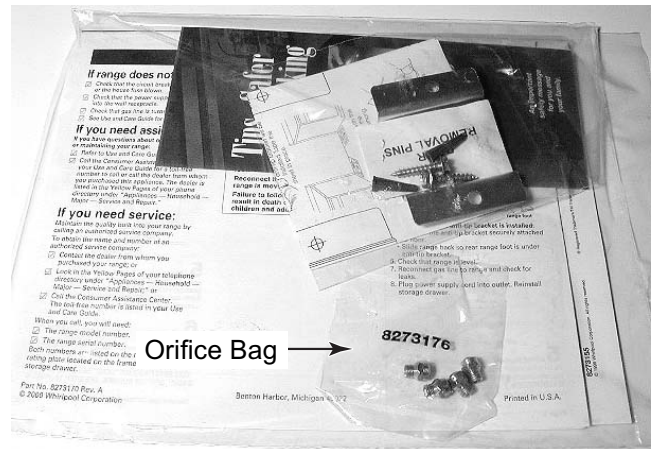

f) Install the four L.P. gas orifices in the burners, (do not overtighten them), as shown in the following chart.

L.P. GAS			
Surface Burner	Propane Rate (B.T.U. /Hr)	Orifice Number	Color Marking
Left Rear	8,000	L80	Black
Left Front	11,000	L99	Green
Right Front	8,000	L80	Black
Right Rear	5,000	L65	Blue

g) Place the natural gas orifices in the orifice bag for possible later use.

3. **To convert the broil burner for use with L.P. gas:**

- a) Pull the range out of its mounting location so that you can access the rear of the unit.
- b) Remove the three screws from the rear panel and remove the panel.

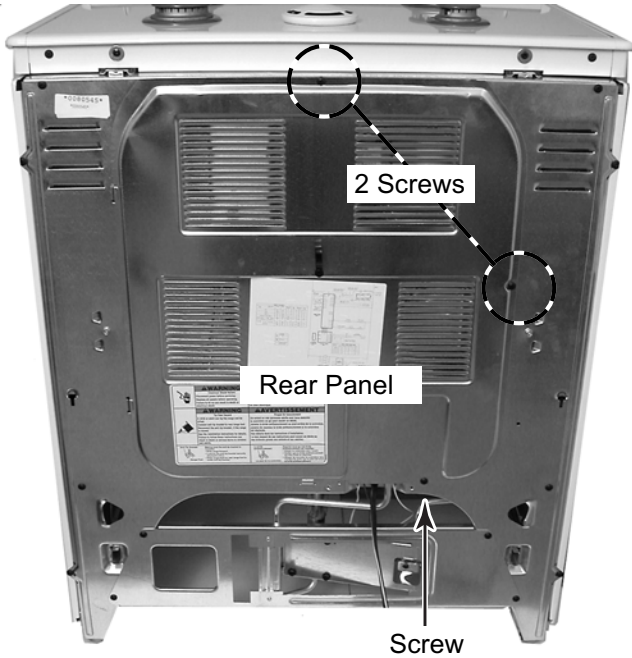

- c) Remove the three screws from the broil tube cover and remove the cover.

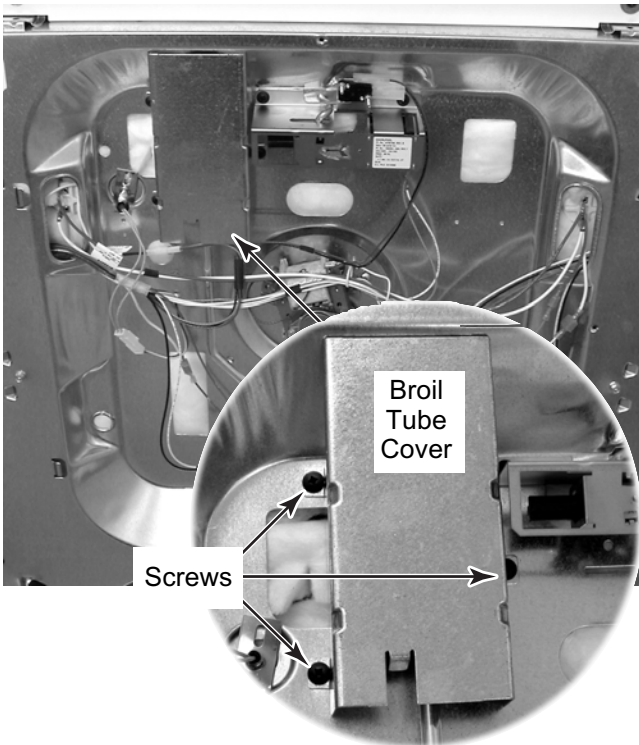

- d) Remove the orifice spud #54 from the broil burner gas line connector, and replace it with L.P. orifice spud #65.

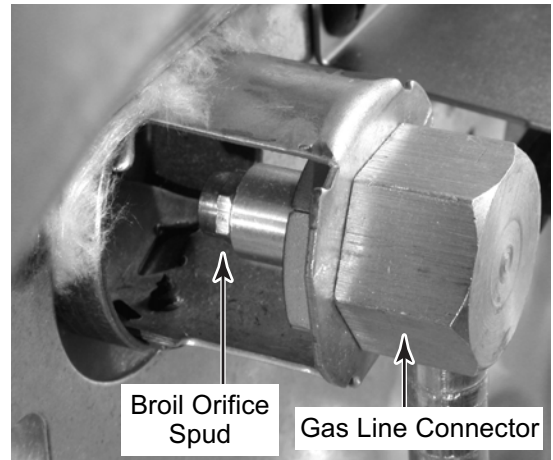

4. **To convert the bake burner for use with L.P. gas:**

- a) Remove the storage drawer.
- b) Use a 1/2" open-end wrench and turn the bake burner orifice hood down snug onto the pin (approximately 2-1/2 turns). **DO NOT OVERTIGHTEN THE ORIFICE.** The burner flame cannot be properly adjusted if this conversion is not made.

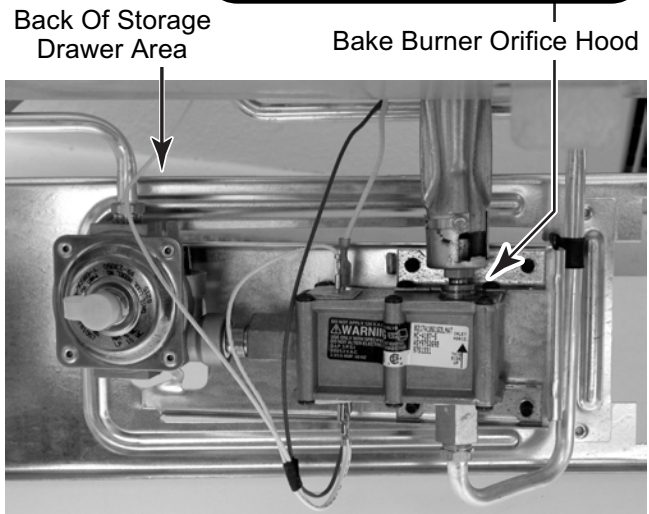
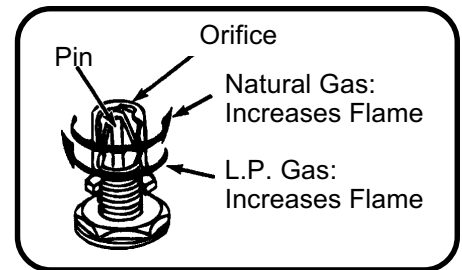

5. To convert the gas distribution valve for use with L.P. gas:

a) Pull the plastic cap off the gas distribution valve.

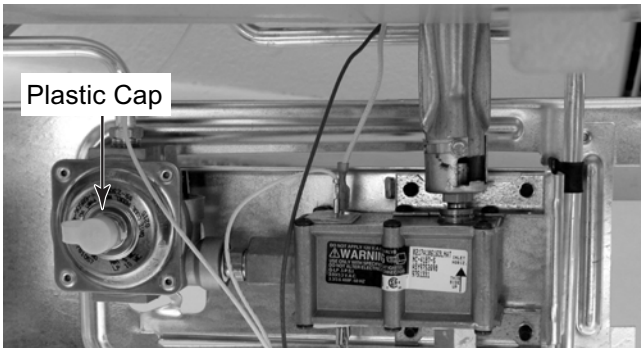

b) Unscrew the conversion cap from the gas distribution valve and remove it and the plastic cap. Note the difference between the L.P. and Natural gas ends of the cap.



Conversion Cap Set For Use With (N) Natural Gas

L.P. Gas Natural Gas

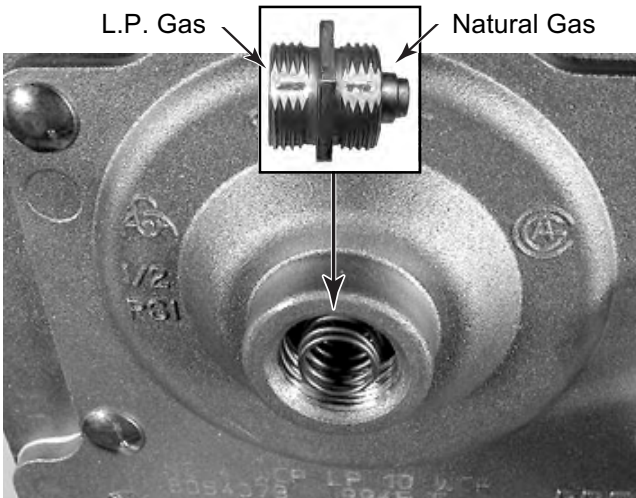

c) Install the loop on the plastic cap over the natural gas side of the conversion cap.

d) Install the plastic cap and the conversion cap on the gas distribution valve with the L.P. side facing up (you will see "LP" stamped inside the cap, as shown below).



Plastic Cap

Conversion Cap Set For Use With L.P. Gas

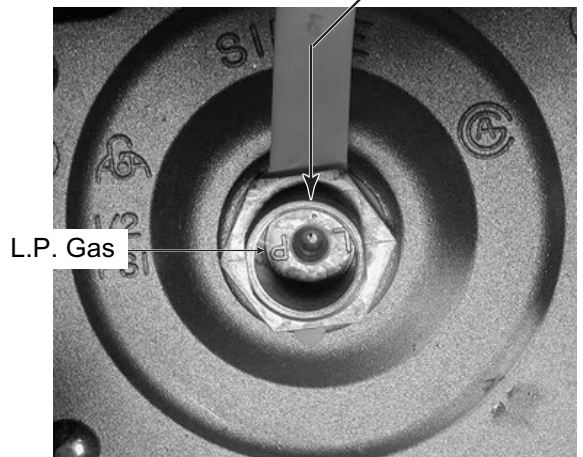

L.P. Gas

6. Reinstall the storage drawer.
7. Turn the gas supply valve handle on.

Gas Valve Handle To "On" Position

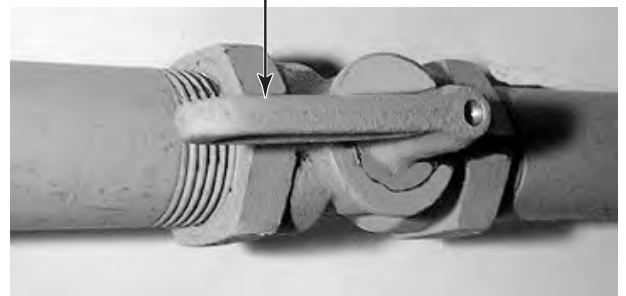

ADJUSTING FOR THE PROPER FLAME

SURFACE BURNERS

1. Turn on one of the surface burners and set the flame to its lowest (LOW) setting. The flame should be steady and the inner cone should be dark blue in color. The size should be approximately 1/4" (0.64 cm) high.
2. If the low flame needs to be adjusted:
 - a) Remove the control knob.
 - b) Look inside the gas valve stem and note the small screw. Insert a small screwdriver into the gas valve stem and fit it in the screw slot.

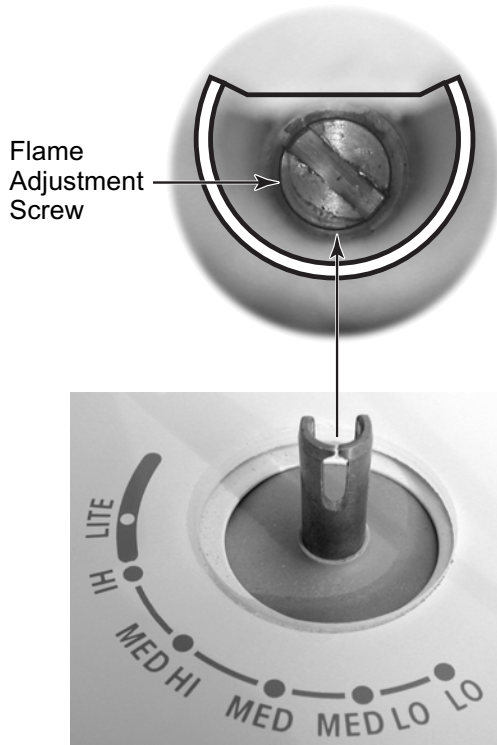

- c) Hold the gas valve stem with a pair of pliers, and turn the screw in either direction until the flame size is approximately 1/4" high.
- d) Replace the control knob.
- e) Turn the control knob from HI to LO and check to make sure that it remains adjusted properly.
- f) Check the other three burners, and adjust them, if necessary.

BAKE BURNER

1. Remove the oven racks and oven bottom.
2. Light the bake burner and check the flame. It should be approximately 1/2" (1.3 cm) high.
3. If the burner flame needs to be adjusted:
 - a) Loosen the locking screw on the burner air shutter.

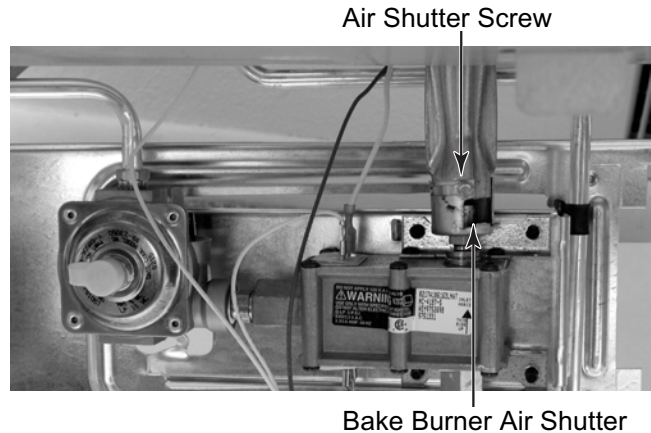

- b) Adjust the air shutter until the flame is the proper height. The inner cone should be bluish-green, and the outer mantle should be dark blue. There should be no blowing or lifting of the flame away from the burner ports. NOTE: Natural gas flame does not have a yellow tip.
- c) Retighten the air shutter screw.

INSTALLING THE ANTI-TIP BRACKET

!WARNING

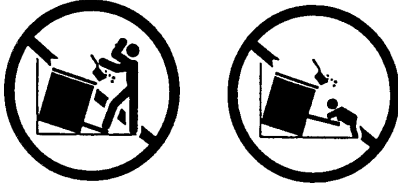

Tip-Over Hazard

A child or adult can tip the range and be killed.

Connect anti-tip bracket to rear range foot.

Reconnect the anti-tip bracket, if the range is moved.

Failure to follow these instructions can result in death or serious burns to children and adults.

PARTS SUPPLIED

Plastic Anchors



Screws



Anti-Tip Bracket



Template

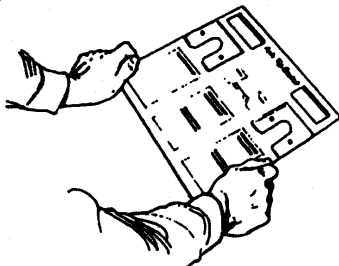

NOTE: The anti-tip bracket can be installed to hold either the right or left rear leg of the range.

1. Determine which leg you wish to anchor to the floor.
2. Place the anti-tip bracket template on the floor in the range opening so that the top edge is against the wall, molding, or cabinet, and the bracket template is in the location where the anti-tip bracket will be installed.
3. Tape the template to the floor.

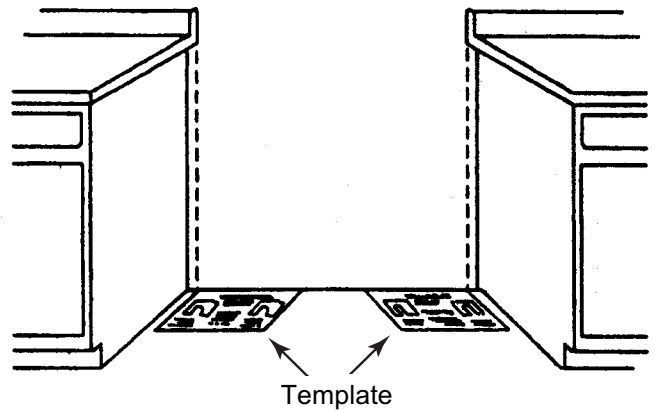

NOTE: For mounting to a wood floor, proceed to step 4. For concrete or ceramic floors, proceed to step 5.

4. **To mount the anti-tip bracket to a wood floor:**

- a) Use the bracket template to mark the hole locations to be drilled.
- b) Use a 1/8" drill bit and drill the two holes.

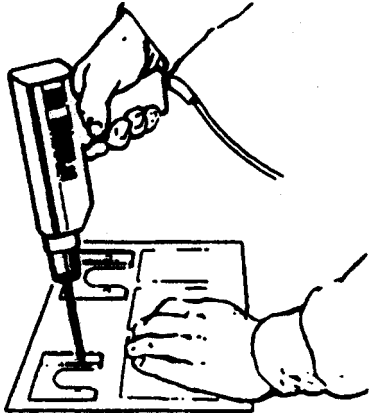

- c) Remove the template from the floor.
- d) Line up the two mounting holes in the anti-tip bracket with the two holes you just drilled in the floor.
- e) Use the two screws that were supplied and fasten the anti-tip bracket to the floor.

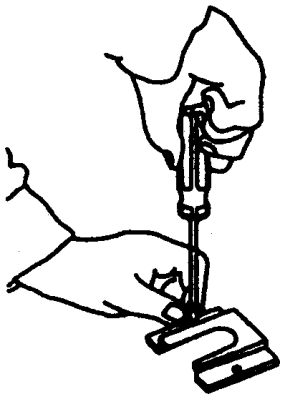

5. **To mount the anti-tip bracket to a concrete or ceramic floor:**

- a) Use the bracket template to mark the hole locations to be drilled.
- b) Use a 3/16" drill bit and drill the two holes.
- c) Remove the template from the floor.
- d) Tap the two plastic anchors into the mounting holes with a hammer.
- e) Line up the two mounting holes in the anti-tip bracket with the two holes you just drilled in the floor.
- f) Use the two screws that were supplied and fasten the anti-tip bracket to the floor.

- 6. Move the range close to the cabinet opening and plug the power supply cord into a grounded outlet.
- 7. Remove the cardboard shipping piece from under the range.
- 8. Move the range into position and make sure that the rear leveling leg slides into the anti-tip bracket, as shown.



THEORY OF OPERATION

ELECTRONIC IGNITION SYSTEM

SEALED BURNER

When a main burner control knob **1** is turned to the "lite" position, the gas valve **2** opens, and gas flows through the gas distribution valve **3** into the manifold **4** through the open valve. As gas passes through the valve and its orifice, it is directed into the venturi **5**, where it mixes with primary air to create the proper mixture necessary for combustion.

At the same time, line voltage is applied through the ignition switch **6**, to the spark module **7**, which produces high-voltage, low amperage pulses to all of the spark ignitors **8**. The pulses cause a spark **9** to occur between the spark ignitor electrode, and the grounded burner cap **10**. The gas and air mixture at the burner is ignited by the spark, and a flame is produced at each of the top burner ports.

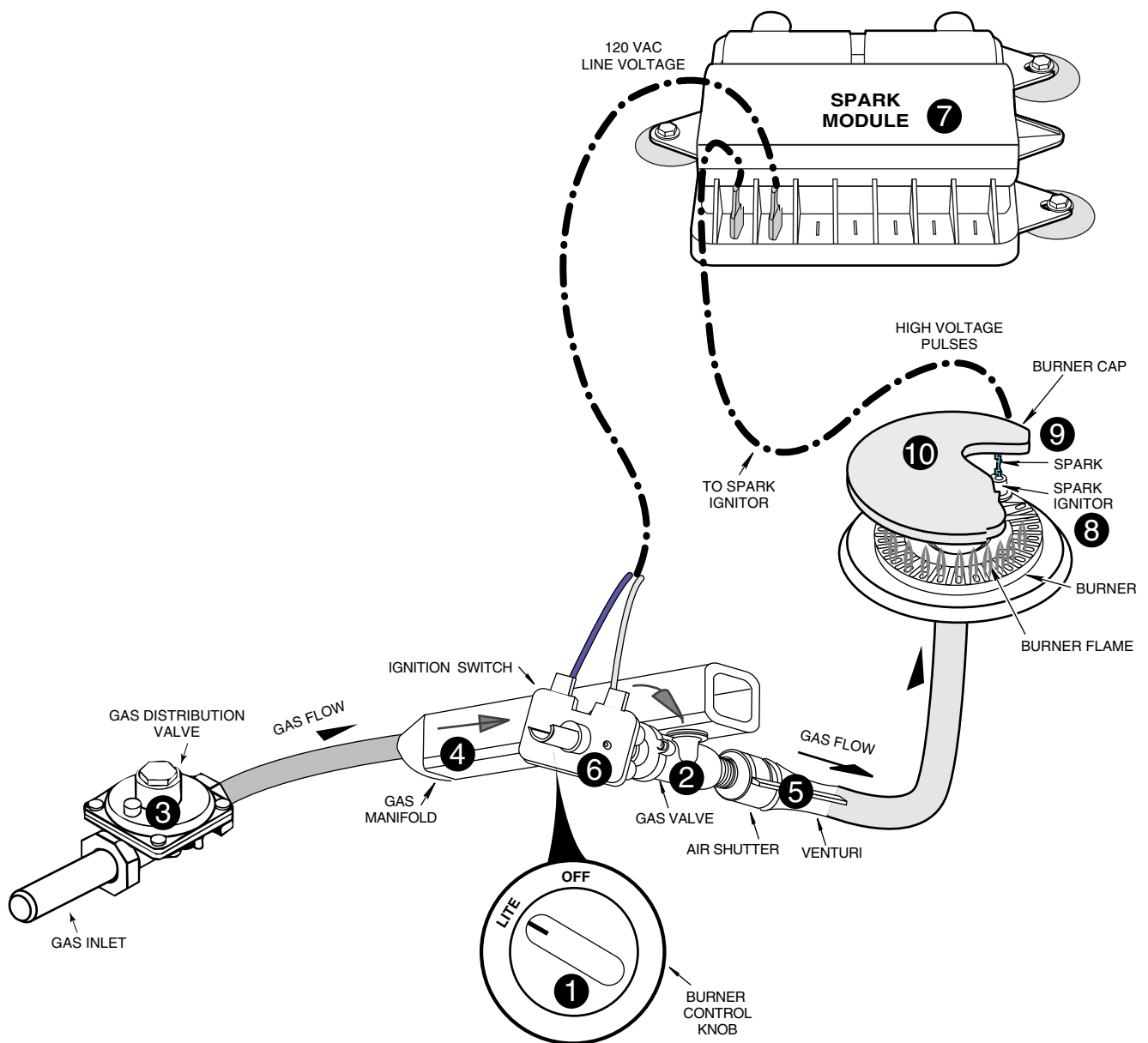

AIR FLOW — REAR PANEL

The gas range needs sufficient air to properly cool the oven. In addition, proper air flow through the gas range also keeps the front control panel from becoming too hot while the elements are operating, causing operational problems.

To help provide the proper air flow along the back of the range, the rear panel of the range has a spacer on each side toward the bottom.

When the range is installed, these spacers should just come in contact with the surface of the wall. If they are accidentally bent in, proper spacing will be lost, and the oven will not heat properly. Also, the front control panel may become overly warm, and cause the bimetal switches to trip, shutting down the operation. If any of these problems occur, it is most likely because of air flow restrictions.

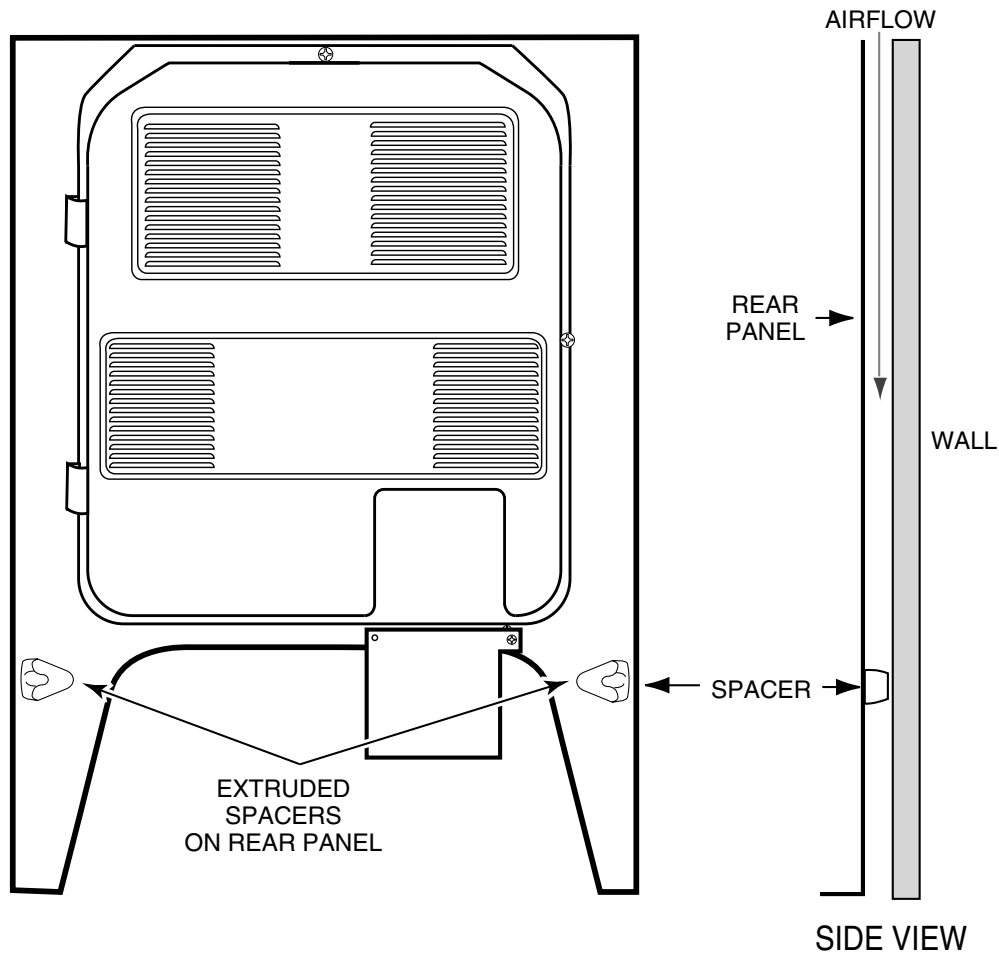

COOLING FAN AIR FLOW

The cooling fan is in series with the cooling fan bimetal switch, which is located under the right side of the control panel. When the temperature of the chassis reaches 40°C (104°F), the bimetal switch closes, and turns on the cooling fan.

The cooling fan draws air from inside the base of the cabinet. It forces the air up the air channel, which is located under the left side panel,

to the opening at the end of the control panel. Air then flows across the chassis below the control panel, and cools it. Air enters through the series of holes in front of the range top, flows beneath it, and exits to the outside through slots in the rear panel. When the control panel chassis temperature drops below 40°C (104°F), the bimetal switch opens, and turns the cooling fan off.

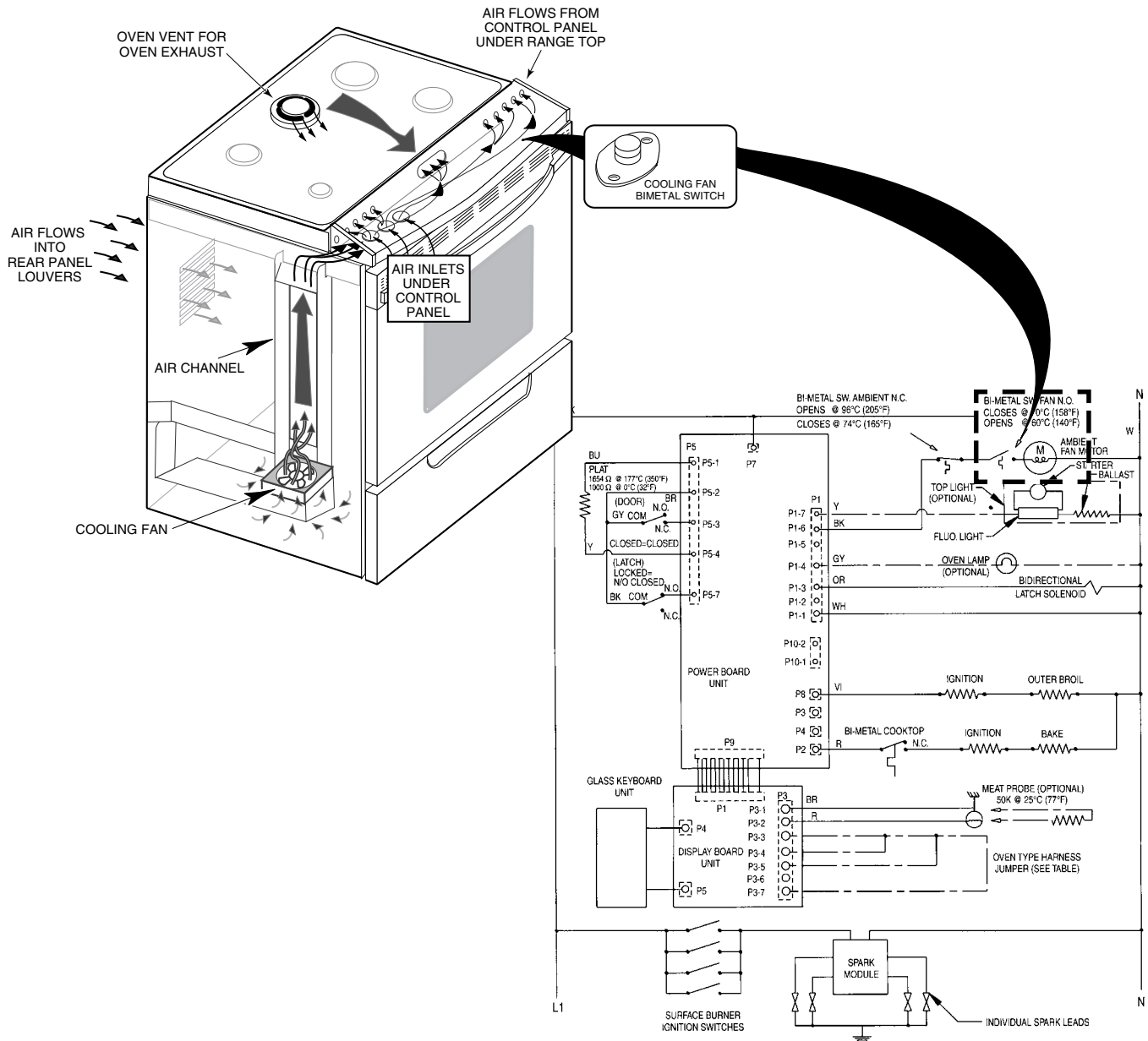

THE BIMETAL SWITCHES

There are two bimetal switches on the gas range. The switches operate as follows:

- **Ambient Bimetal Switch (N.C.)** (Inset #1) —This switch is located under the left side of the control console. It opens the L1 circuit to the electronic control board if the console temperature reaches 96°C/205°F.

- **Cooling Fan Bimetal Switch (N.O.)** (Inset #2) —This switch is located under the right side of the control console. It turns the cooling fan on if the console temperature reaches 70°C/158°F.

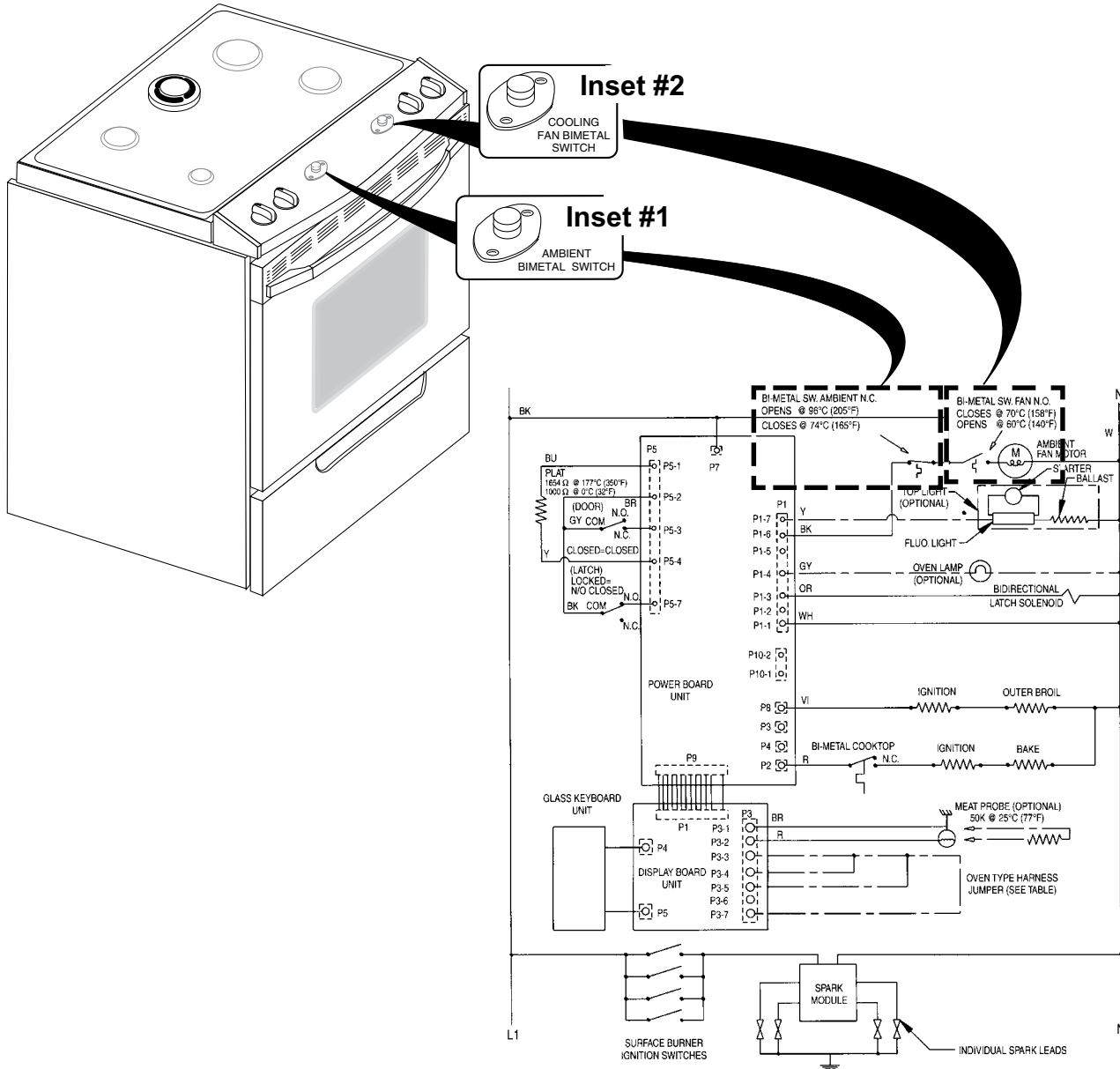

THE DOOR LOCK SOLENOID & DOOR LATCH SWITCH

The door lock solenoid operates on a 120-volt pulse from the electronic control board. When the door is in the unlocked position, the plunger is extended. When the door latch switch is open, the control senses that the door is unlocked. When the door latch switch closes, the control senses that the door is locked. The door latch switch, mounted on the solenoid bracket, is in the N.O. (normally-open) position.

During the self-clean cycle, the control board sends a 120-volt pulse to the solenoid windings, which pulls the plunger in, and moves the latch actuator rod to lock the oven door. The movement of the rod also actuates the door latch switch and closes it. When the self-clean cycle is over, the control board sends a 120-volt pulse to the solenoid, the plunger is pushed out, the latch actuator rod releases the door, and the door latch switch opens.

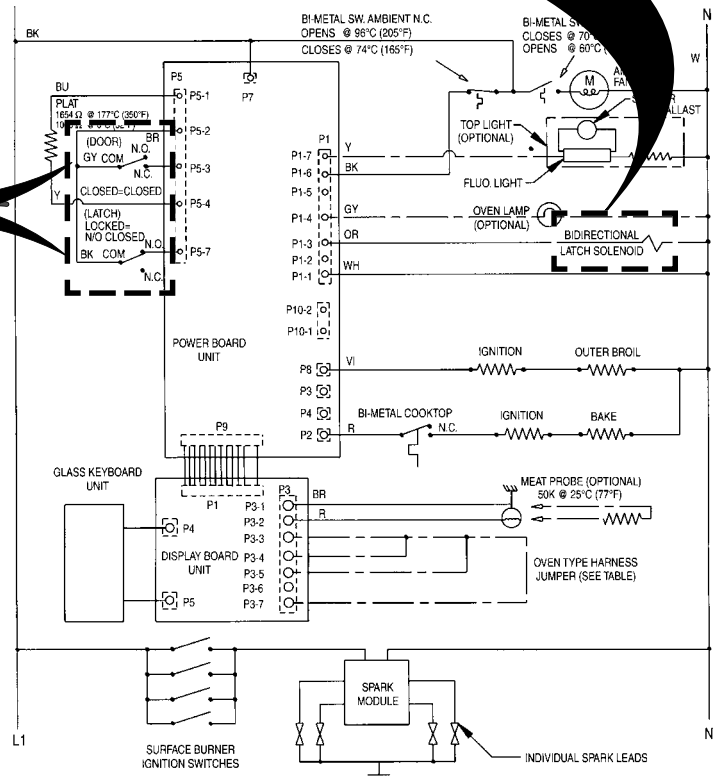
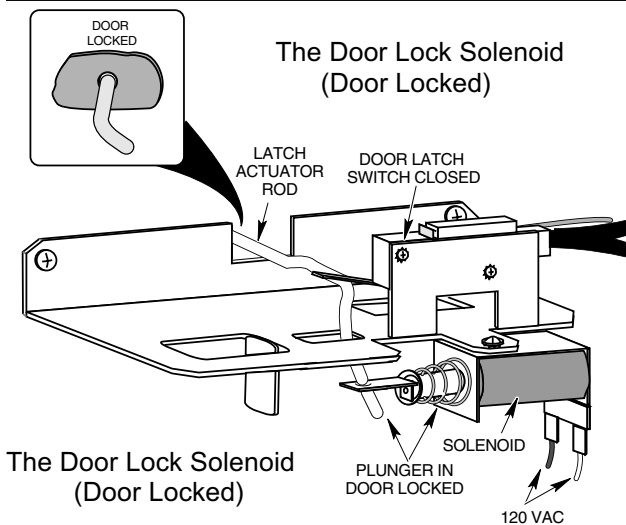
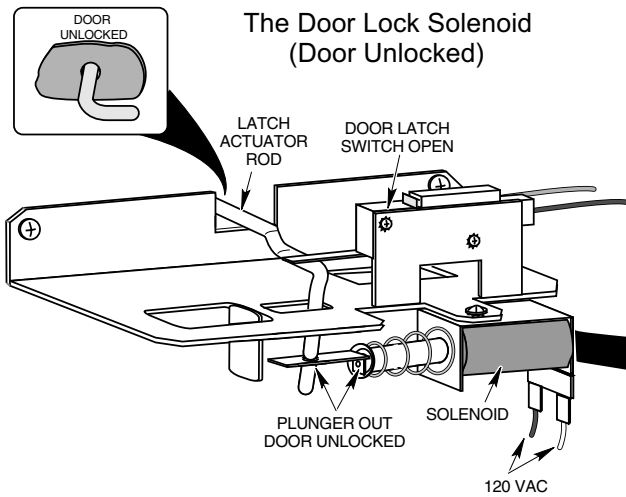

HOW THE SELF-CLEAN CYCLE WORKS

The Self-Clean cycle uses high heat to burn away soil and grease from inside the oven. During this cycle, the oven will get much hotter than it does under normal baking and broiling conditions (see the following chart).

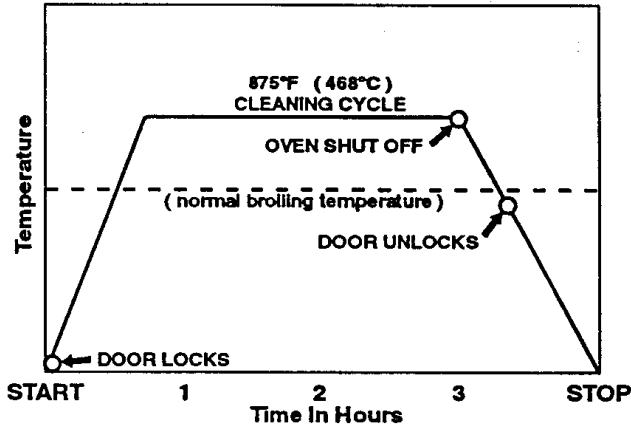

The oven is preset for a 3-1/2 hour Self-Clean cycle. However, you can adjust this cycle time to between 2-1/2 and 4-1/2 hours. The chart shows a normal 3-1/2 hour Self-Clean cycle. Note that although the heating turns off after 3 hours, the door will remain locked for an additional 1/2 hour so the oven can cool sufficiently.

During the Self-Clean cycle, the broil burner is on for the first 30 minutes. The rest of the Self-Clean cycle is completed using the bake burner only. If the door latch switch is not activated during the clean operation, the cycle is terminated, and the display will show "close door."

FIRST 30 MINUTES OF CLEAN

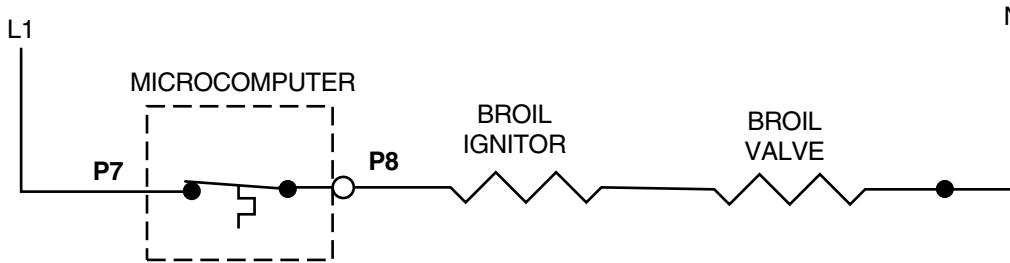

AFTER 30 MINUTES OF CLEAN

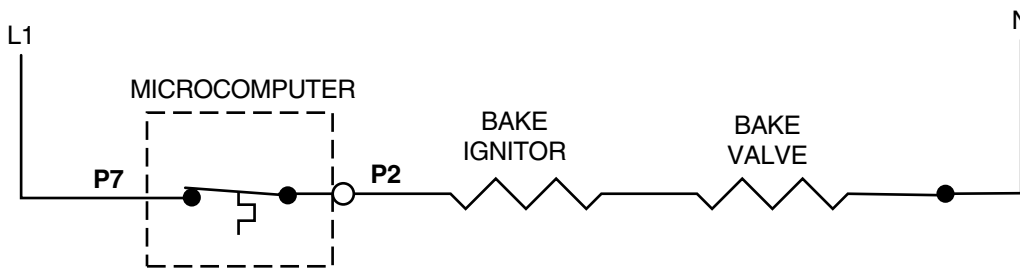

COMPONENT ACCESS

This section instructs you on how to service each component inside the gas range. The gas range components and their locations are shown below.

COMPONENT LOCATIONS

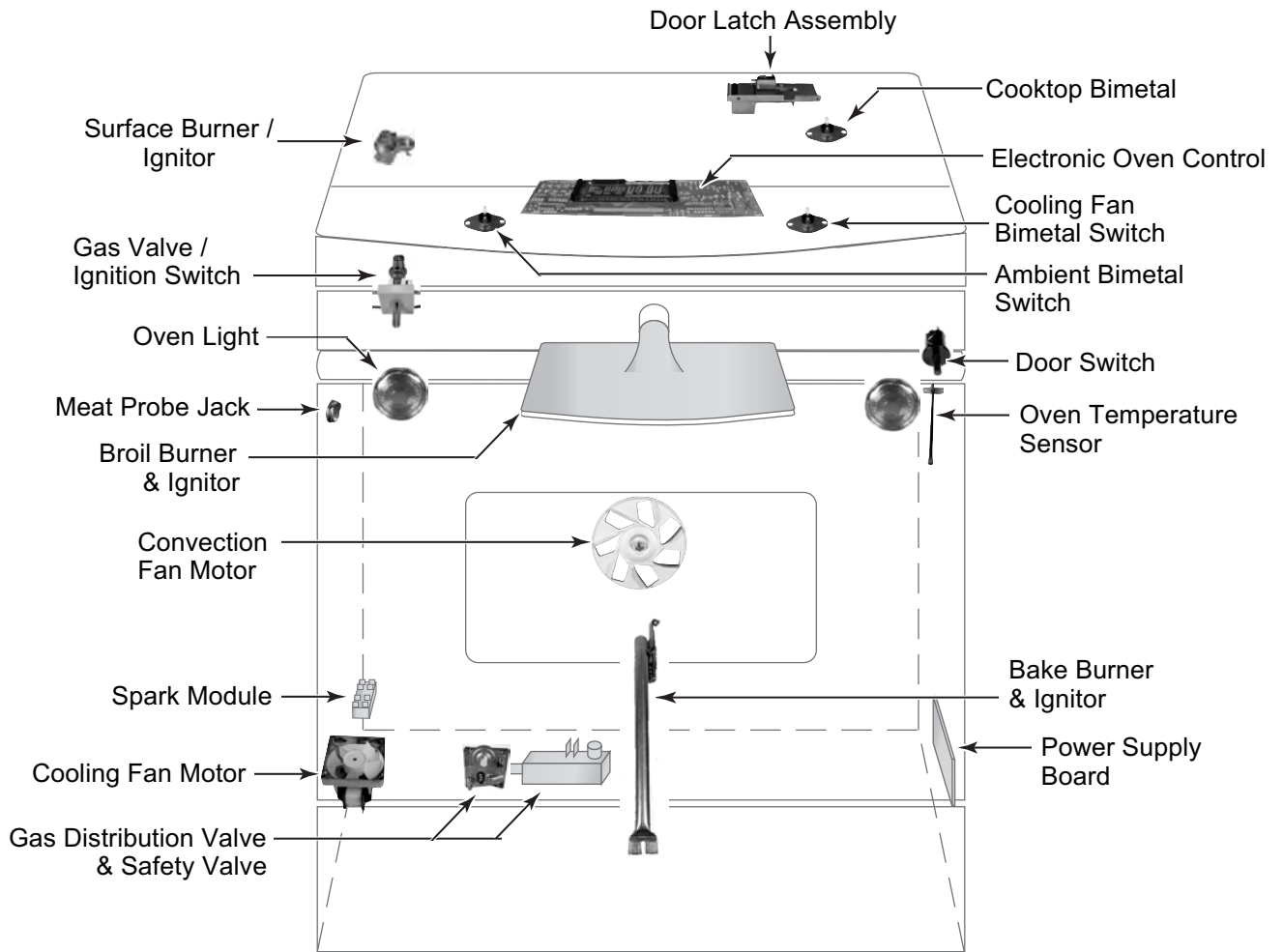

REMOVING THE CONTROL PANEL, IGNITION SWITCHES, A GAS VALVE, AND A BIMETAL SWITCH

! WARNING	
	<p>Electrical Shock Hazard Disconnect power before servicing. Replace all parts and panels before operating. Failure to do so can result in death or electrical shock.</p>
	<p>Fire Hazard Shut off gas supply line valve before servicing. Check all gas line connections and replace all parts and panels before operating. Failure to do so can result in explosion, fire or other injury.</p>

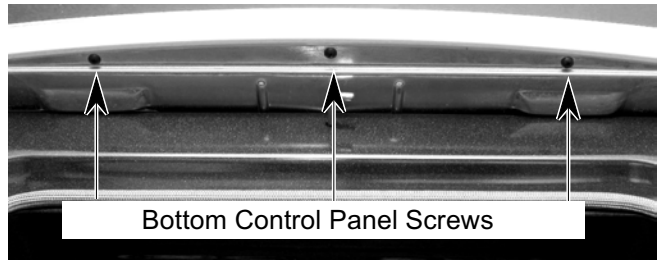

c) Pull the knobs off the gas valves.



d) Lift the front of the control panel, pull it forward, and slide the front edge of the cooktop glass out of the slot in the front of the panel.

e) Rotate the control panel up and over so the bottom side faces up.

1. Turn off gas supply and disconnect power to the range.
2. Pull the range forward far enough to access the end cap screws.
3. Remove the grates from the range.
4. **To remove the control panel:**
 - a) Remove the screw from each end cap.

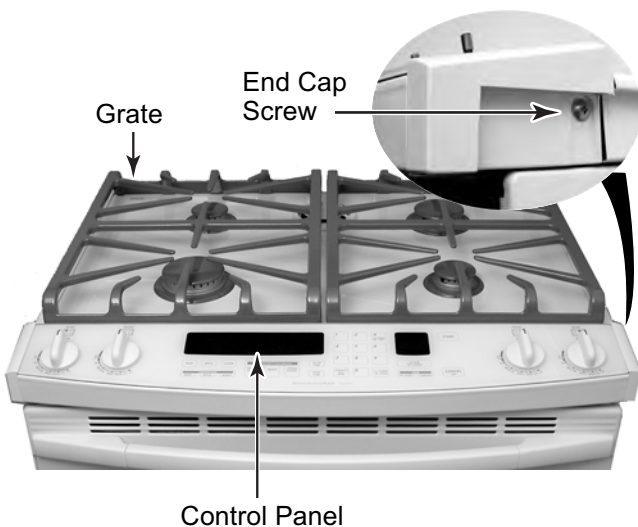

b) Open the oven door and remove the three screws from the bottom of the control panel (see the photo at the top of the right column).

Left Gas Valves & Ignition Switches

Right Gas Valves & Ignition Switches

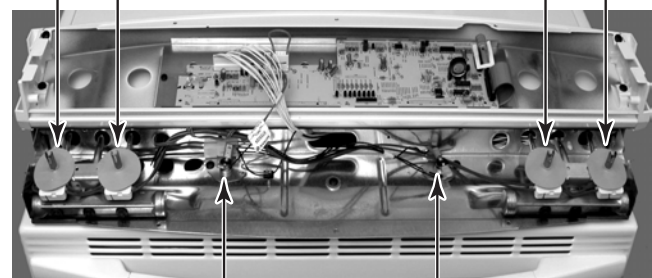

Ambient (N.C.)
Bimetal Switch
Opens @ 96°C (205°F)
Resets @ 74°C (165°F)

Cooling Fan (N.O.)
Bimetal Switch
Resets @ 70°C (158°F)
Closes @ 60°C (140°F)

5. To remove the ignition switches:

NOTE: The ignition switches must be replaced as an assembly. They cannot be replaced individually.

- a) Pull the rubber guard off each of the valve stems.

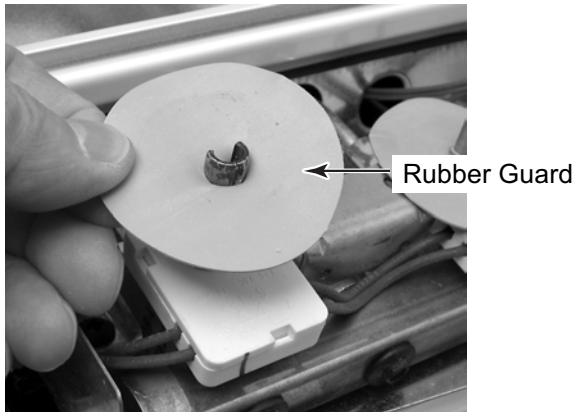

- b) Pull up on the ignition switches and unsnap them from the gas valves, then pull the switches off the valve stems and remove them.



- c) Disconnect the ignition switch wire connector from the main harness and remove the ignition switches.



6. To remove a gas valve:

- a) Pull the rubber guard off the valve stem (see step 5a).
- b) Pull up on the ignitor switch and unsnap it from the gas valve, then pull the switch off the valve stem and remove it (see step 5b).
- c) Unscrew the 1/2" gas line connector from the gas valve.
- d) Remove the 1/4" hex-head gas valve mounting screw and its rubber seal from the front of the gas manifold.

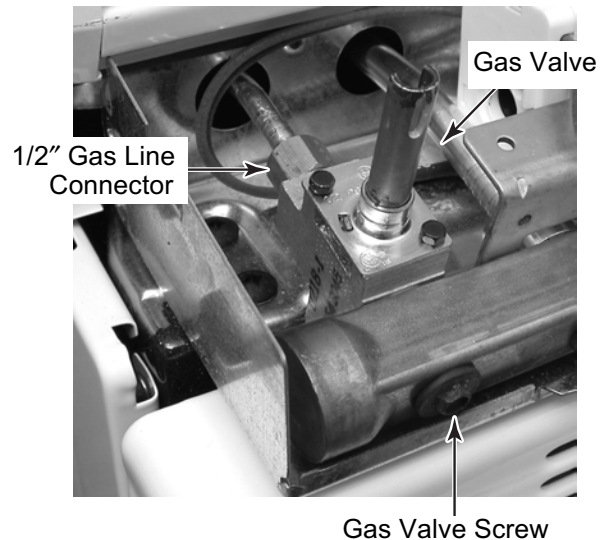

- e) Pull the front of the gas valve out of the manifold and remove the valve.

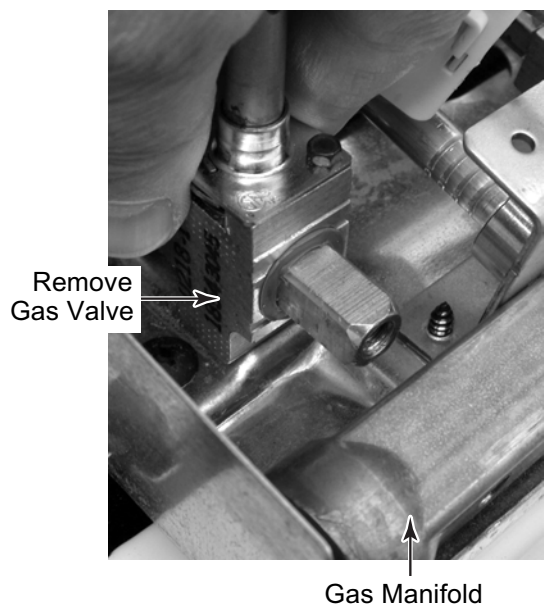

Continued on the next page.

7. To remove a bimetal switch:

- a) Remove the wires from the terminals.
- b) Remove the mounting screw.

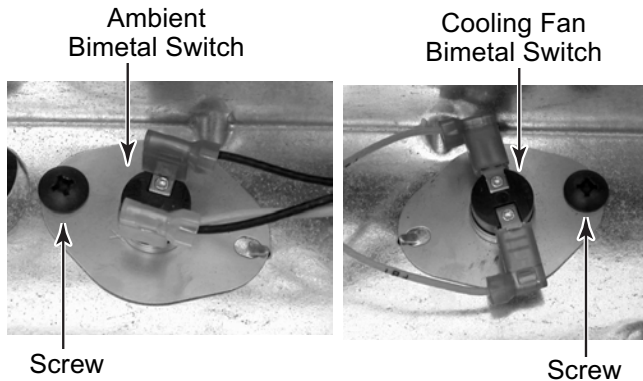

REASSEMBLY NOTES:

- Before reinstalling the gas valve, make sure that the rubber seals on the mounting screw, and on the valve, are not cracked or damaged. If they are, replace them.
- Perform a leak check on the gas valve after reinstalling it. Use a soap bubble method to perform the check.

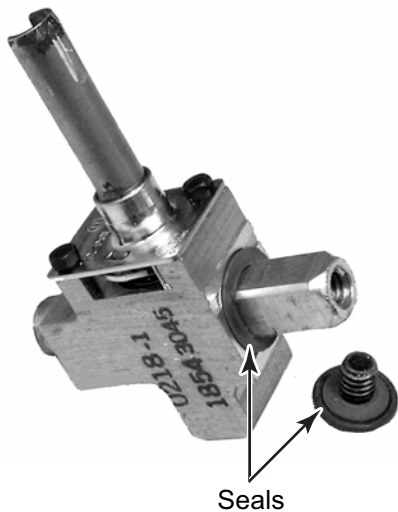

- When reinstalling the control panel, insert the groove in the front of the panel over the front edge of the cooktop glass, and lower it onto the front of the range. Be careful not to pinch any of the wires between the front edge of the control panel and the chassis.

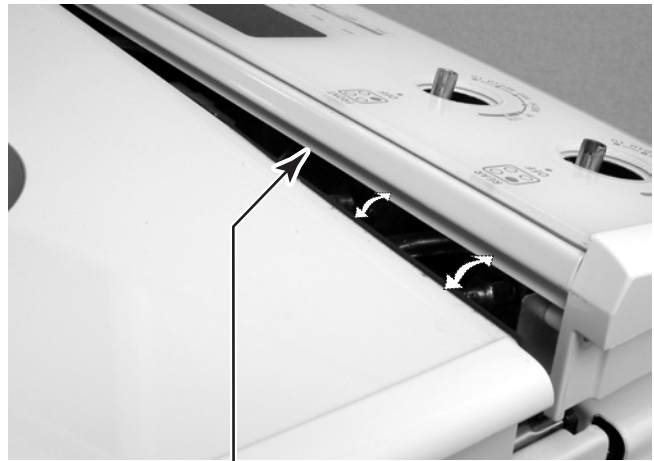

REMOVING THE DOOR LATCH ASSEMBLY

⚠️ WARNING



Electrical Shock Hazard
 Disconnect power before servicing.
 Replace all parts and panels before operating.
 Failure to do so can result in death or electrical shock.



Fire Hazard
 Shut off gas supply line valve before servicing.
 Check all gas line connections and replace all parts and panels before operating.
 Failure to do so can result in explosion, fire or other injury.

1. Turn off gas supply and disconnect power to the range.
2. Pull the range out of its mounting location so that you can access the rear of the unit.
3. **To remove the door latch assembly:**
 - a) Remove the top and side screws from the rear panel and loosen the bottom screw, then pull the tabs out of their slots, and remove the panel.

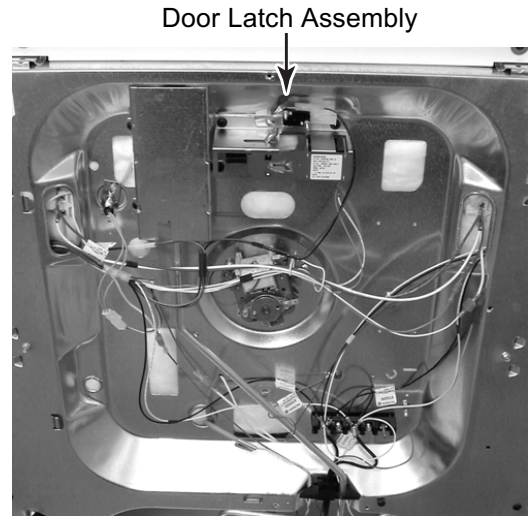
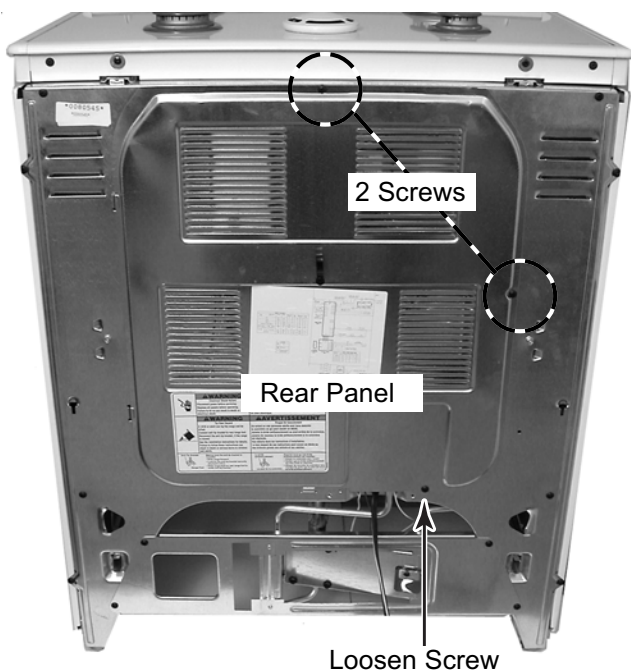

- b) Disconnect the 3-wire connector from the door latch switch terminals.
- c) Disconnect the wires from the door latch solenoid terminals.
- d) Remove the two screws from the door latch assembly and remove it from the unit.

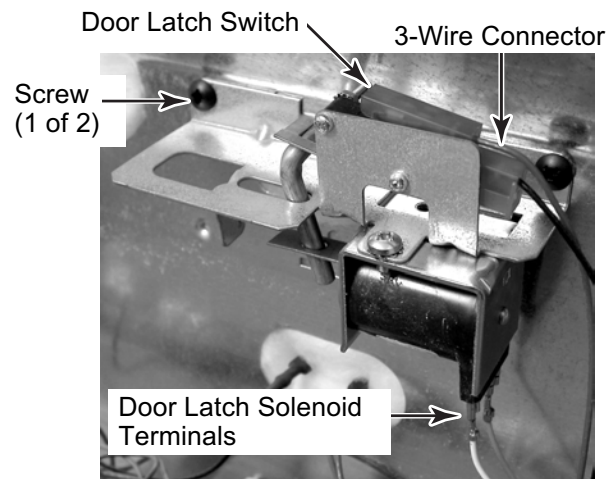

REASSEMBLY NOTE: When you reinstall the door latch assembly, make sure that the door latch switch actuator is over the latching rod, as shown.

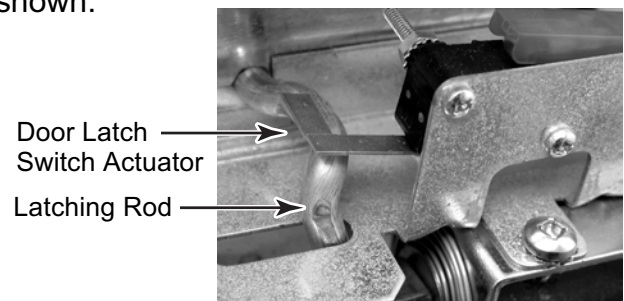

REMOVING THE ELECTRONIC OVEN CONTROL BOARD AND THE TOUCH / CONTROL PANEL ASSEMBLY

⚠️ WARNING



Electrical Shock Hazard
 Disconnect power before servicing.
 Replace all parts and panels before operating.
 Failure to do so can result in death or electrical shock.



Fire Hazard
 Shut off gas supply line valve before servicing.
 Check all gas line connections and replace all parts and panels before operating.
 Failure to do so can result in explosion, fire or other injury.

1. Turn off gas supply and disconnect power to the range.
2. Remove the control panel from its subchassis, (see page 4-2 for the procedure), and rotate it forward onto the cooktop glass.

Electronic Oven Control

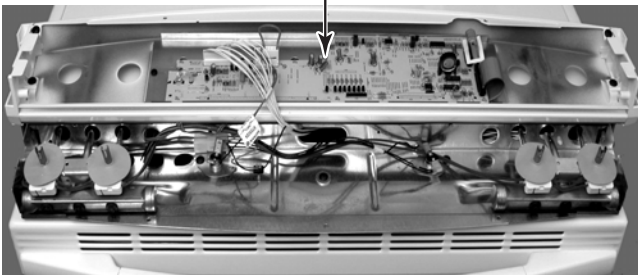

3. To remove the electronic oven control board (see the photo at the top of the next column):
 - a) Disconnect the wire connectors at P1, P11, and P3.
 - b) Remove the paper support from the ribbon cable at connector P5.

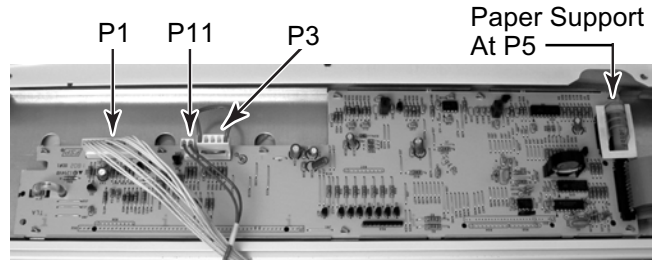

- c) Squeeze the end tabs on the ribbon cable locking ring and pull the locking rings and ribbon cables out of their connectors at P4 and P5.

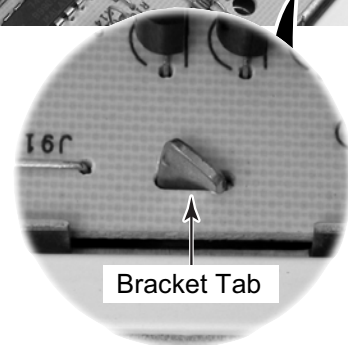
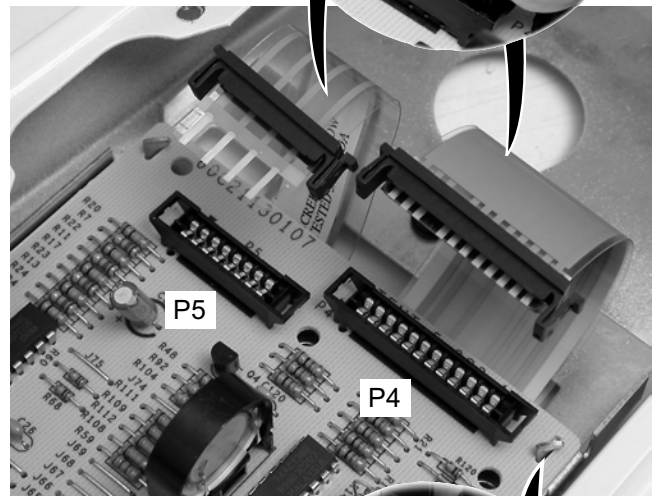
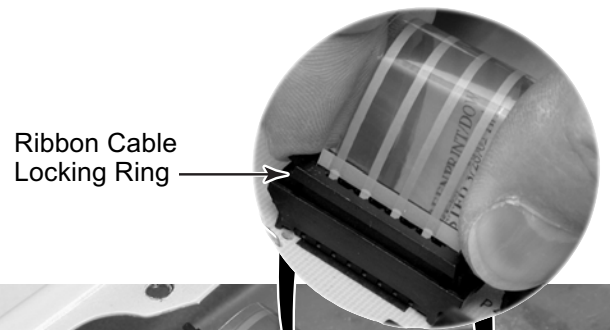

- d) Straighten the nine bracket tabs so that they fit through the board slots, and remove the electronic oven control board from the bracket.

4. **To remove the touch/control panel assembly:**

- a) Remove the ribbon cables at P4 and P5 (see step 3c on page 4-6).
- b) Remove the locking rings from the notched ends of the two ribbon cables, and install them on the ends of the new touch / control panel assembly ribbon cables.

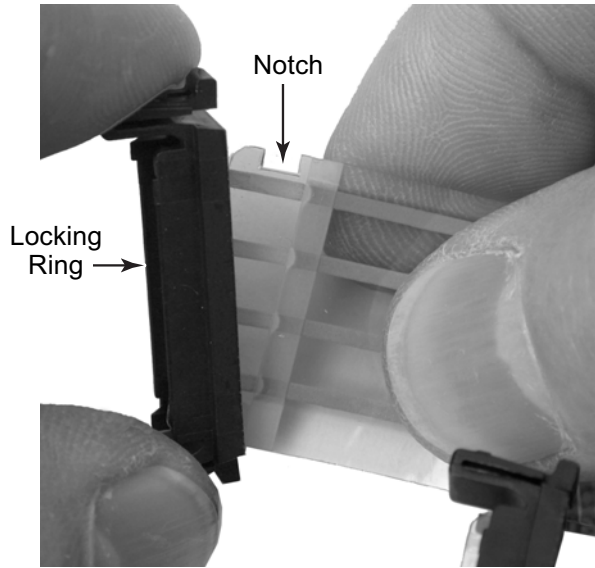

- c) Remove the two screws from the electronic oven control board bracket and remove the board and bracket from the control panel assembly.

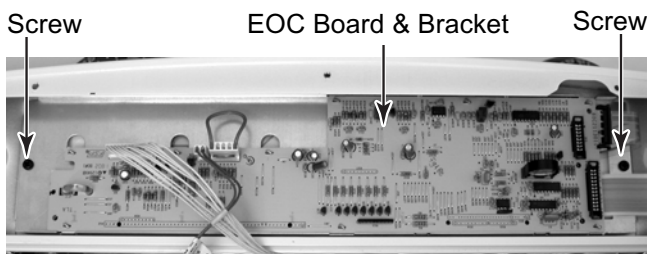

- d) Remove the two screws from each of the two end caps and remove the caps.

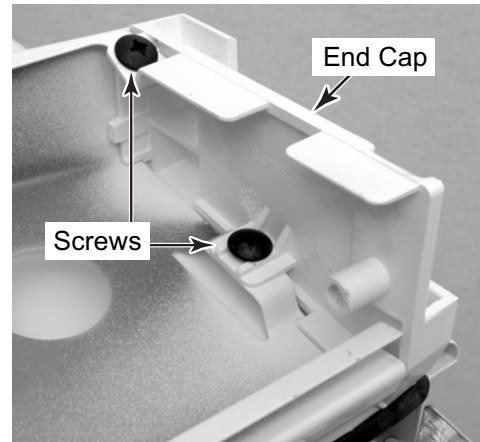

NOTE: The touch/control panel and glass are replaced as an assembly.

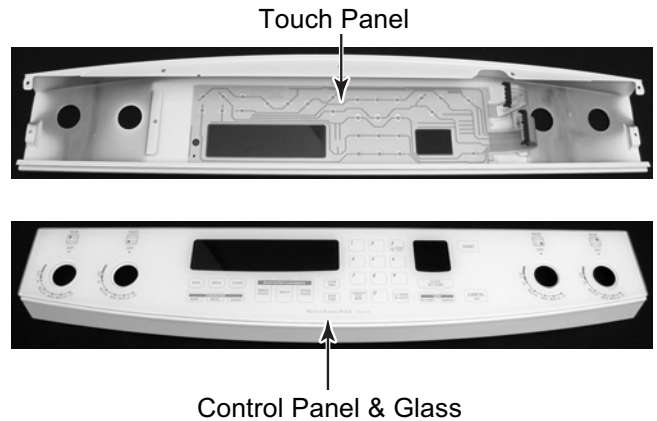

REMOVING THE COOKTOP BIMETAL & A SURFACE BURNER / IGNITOR

! WARNING



Electrical Shock Hazard
 Disconnect power before servicing.
 Replace all parts and panels before operating.
 Failure to do so can result in death or electrical shock.



Fire Hazard
 Shut off gas supply line valve before servicing.
 Check all gas line connections and replace all parts and panels before operating.
 Failure to do so can result in explosion, fire or other injury.

1. Turn off gas supply and disconnect power to the range.
2. Remove the grates and burner caps.

Surface Burner Grate



Burner Cap

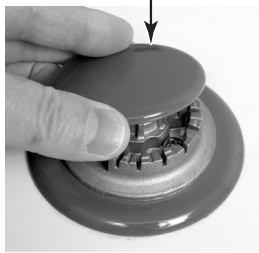

3. Remove the two screws from each of the burner heads and lift the heads off the cooktop.

Burner Head & 2 Screws

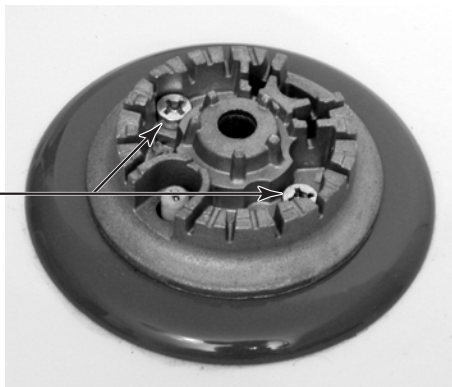

4. Remove the screws from the decorative cover and remove the cover.

Decorative Cover & Screws

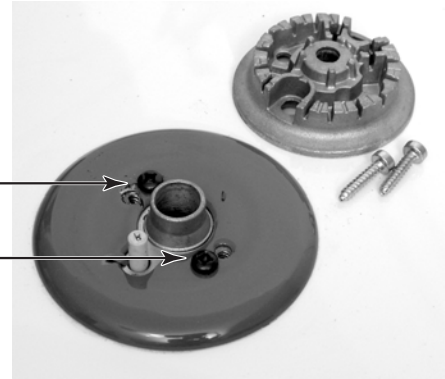

5. Remove the control panel from its subchassis, (see page 4-2 for the procedure), and rotate it forward onto the cooktop glass.
6. Remove the five screws and the flat washer from the control panel subchassis.

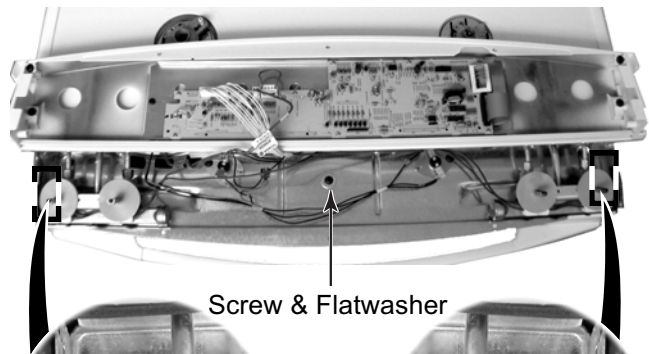

Screw & Flatwasher

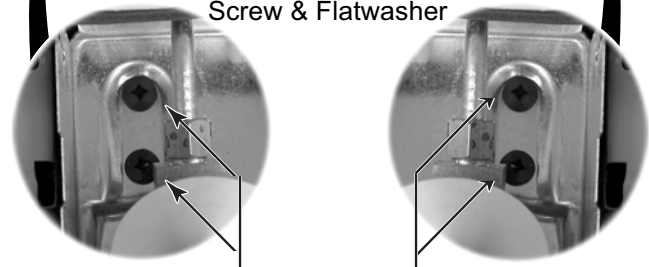

Left & Right Subchassis Screws

7. Move the control panel back into place over the chassis, then lift the front of the cooktop assembly, and prop it up with a piece of board so that you can access the components. **CAUTION:** Be careful that the cooktop does not accidentally fall.

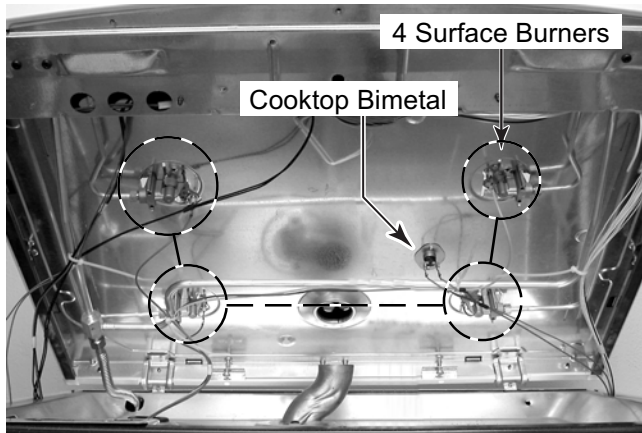

8. **To remove the cooktop bimetal:**

- a) Disconnect the two wires from the bi-metal terminals.
- b) Bend the two tabs down and remove the bimetal from the bottom of the cooktop.

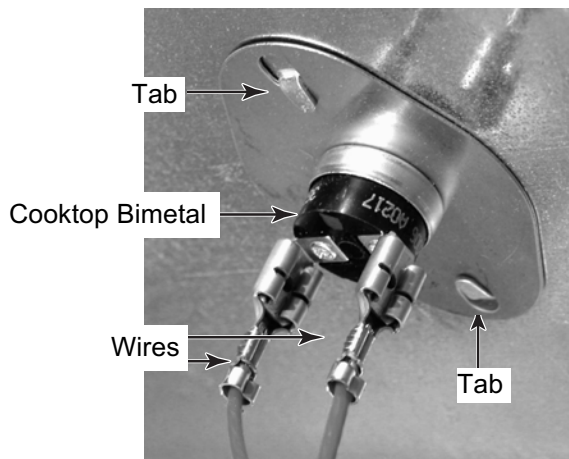

9. **To remove an ignitor:**

- a) Disconnect the ignitor wire from the terminal.
- b) Remove the screw from the ignitor.

10. **To remove a surface burner:**

- a) Remove the screw from the ignitor and remove the ignitor from the surface burner.
- b) Remove the gas line nut from the surface burner.
- c) Lift the surface burner out the top of the cooktop.

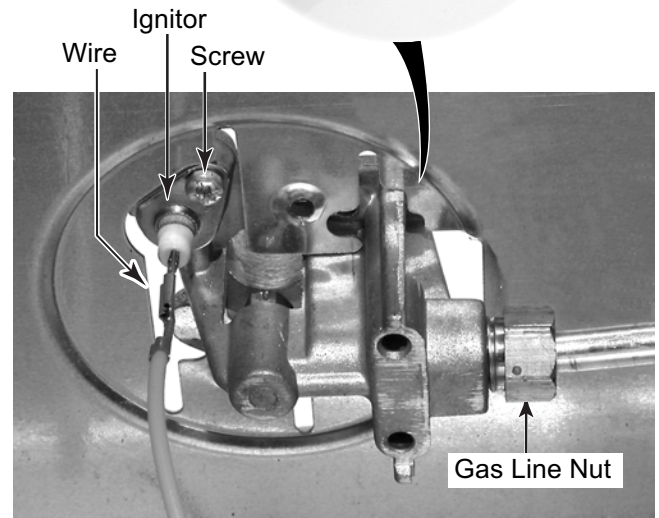
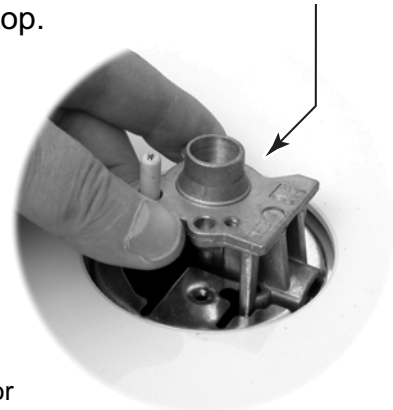

REMOVING THE COOKTOP GLASS & VENT

!WARNING



Electrical Shock Hazard
 Disconnect power before servicing.
 Replace all parts and panels before operating.
 Failure to do so can result in death or electrical shock.



Fire Hazard
 Shut off gas supply line valve before servicing.
 Check all gas line connections and replace all parts and panels before operating.
 Failure to do so can result in explosion, fire or other injury.

1. Turn off gas supply and disconnect power to the range.
2. Pull the range out of its mounting location so that you can access the side trim.
3. Remove the control panel from its subchassis, (see page 4-2 for the procedure), and set it on the front of the unit.
4. Lift the vent cover off the cooktop.
5. Remove the two screws from the left and right side trim. Do not remove the trim at this time.

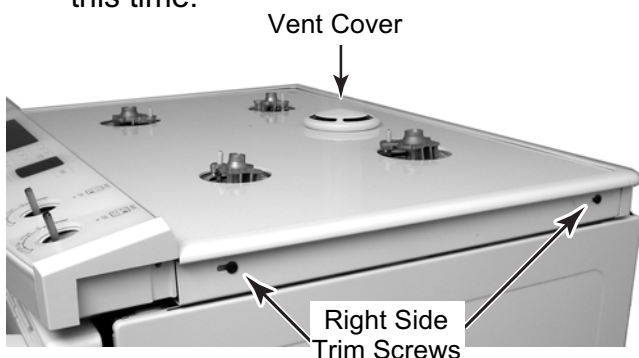

6. Raise the cooktop and prop it up (see pages 4-8 and 4-9 for the procedure).

7. Remove the rubber spacer strips from the edges of the left and right side trim.
8. Loosen the tension bracket screws and remove the brackets from behind the left and right side trim.

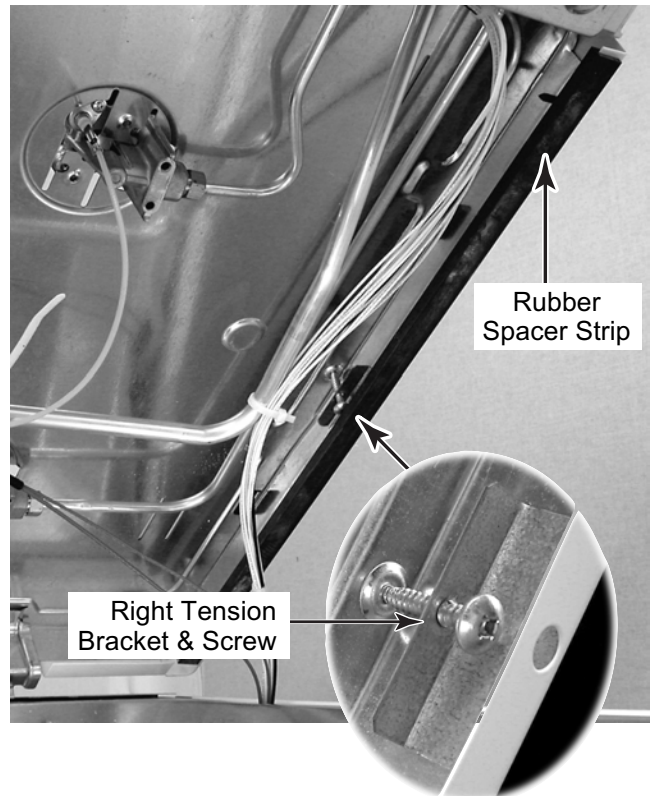

9. Pull the front of the side trim off the cooktop glass, and slide the trim forward off the rear trim.



10. Lower the cooktop and position the control panel forward, away from the edge of the glass.
11. **To remove the cooktop glass**, lift the front edge, pull it forward, and remove the rear edge from under the rear trim.

IMPORTANT: When you reinstall the cooktop glass, keep the side edges of the glass inside the four alignment tabs (two on each side). If the glass is over the tabs, it could break when you lower it.

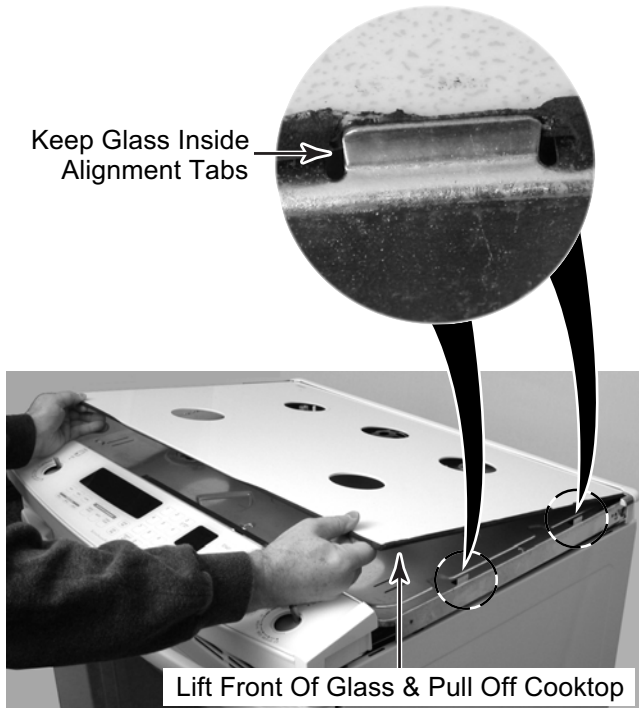

12. **To remove the vent**, lift it off the vent opening. **NOTE:** Check the condition of the rubber drip seals. If they are cracked or torn, replace them before reinstalling the glass.

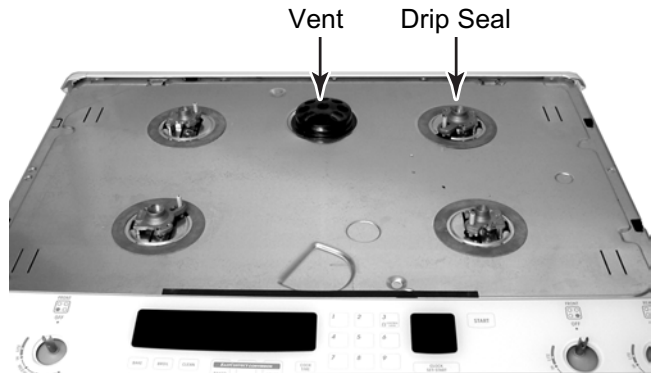

REMOVING THE CONVECTION FAN MOTOR

!WARNING



Electrical Shock Hazard

Disconnect power before servicing.
Replace all parts and panels before operating.
Failure to do so can result in death or electrical shock.



Fire Hazard

Shut off gas supply line valve before servicing.
Check all gas line connections and replace all parts and panels before operating.
Failure to do so can result in explosion, fire or other injury.

1. Turn off gas supply and disconnect power to the range.
2. Pull the range out of its mounting location so that you can access the rear of the unit.
3. Open the oven door and remove the racks from inside the oven.

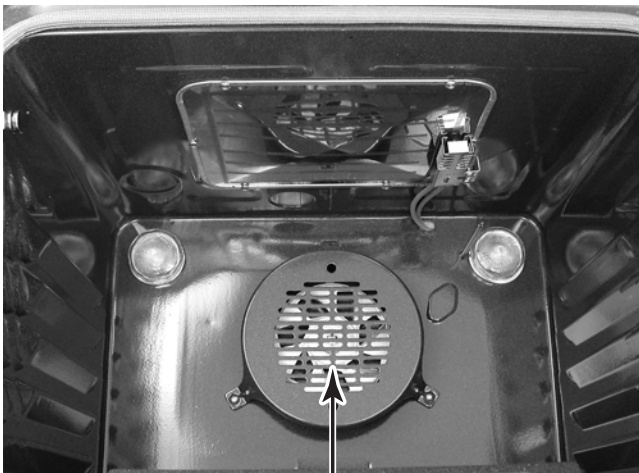

Convection Fan Motor

4. Remove the two screws from the convection fan motor cover, then unhook the tab from the liner slot, and remove the cover.

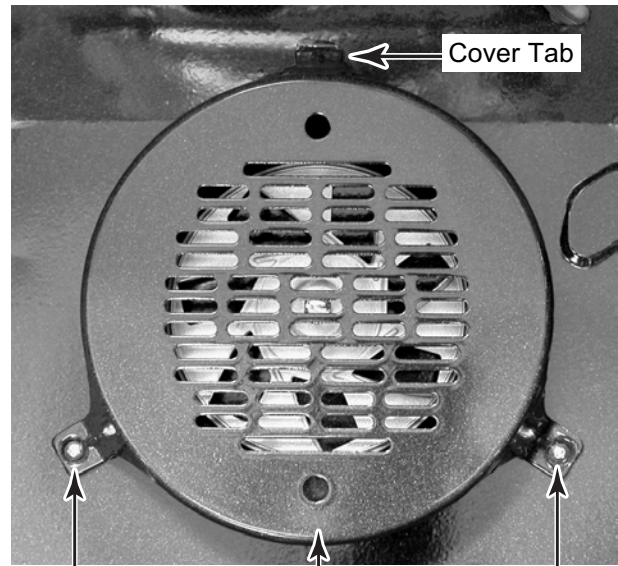

Screw & Lockwasher

Convection Fan Motor Cover

Screw & Lockwasher

5. Use a 13 mm socket and remove the cap nut (clockwise) from the convection fan, then pull the fan off the convection fan motor shaft.

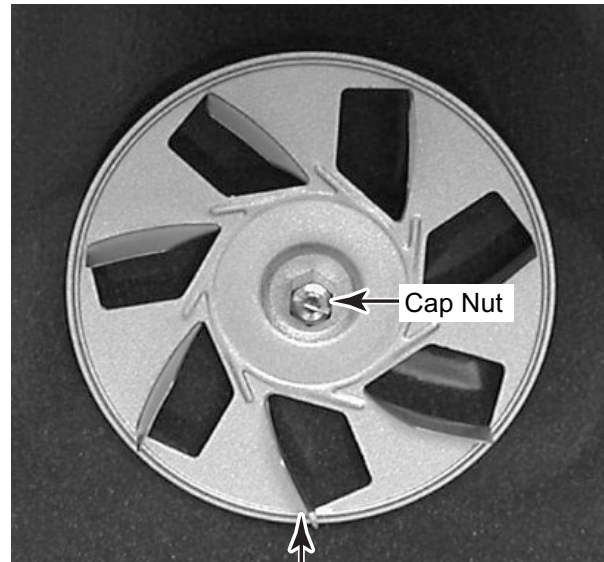

Convection Fan

6. Remove the rear panel (see page 4-5 for the procedure).

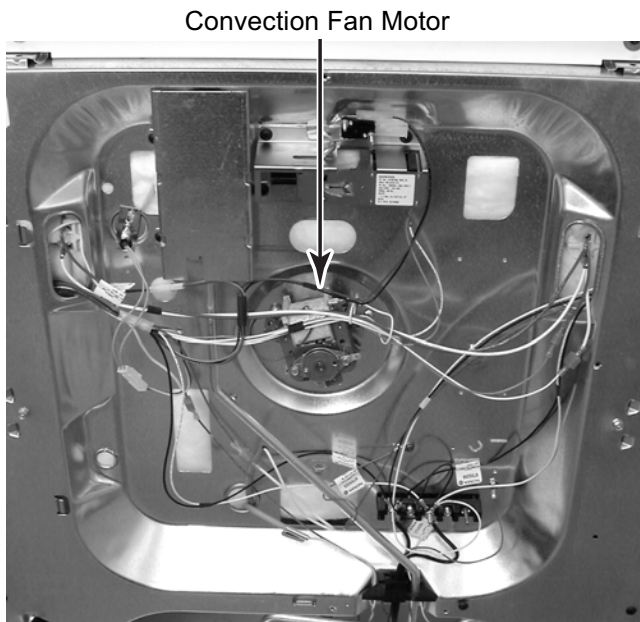

7. Disconnect the wires from the convection fan motor terminals.
8. Remove the three screws from the convection fan motor and remove it from the rear of the unit..

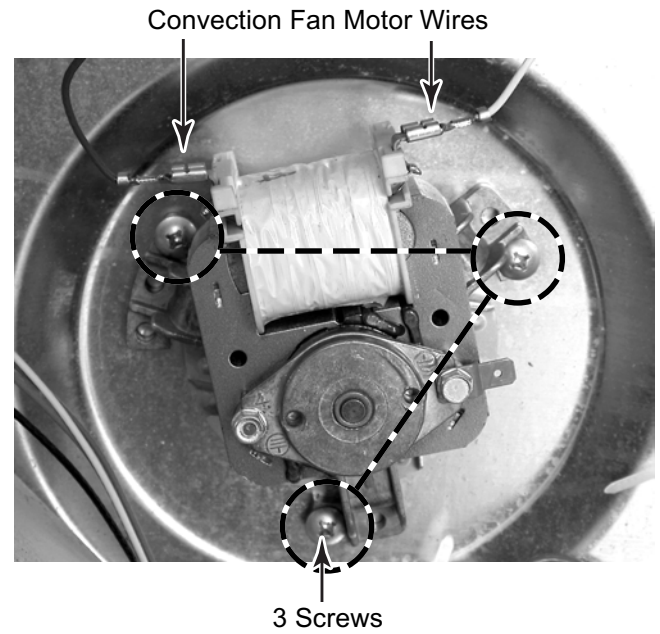

REMOVING AN OVEN LIGHT SOCKET ASSEMBLY

! WARNING



Electrical Shock Hazard
 Disconnect power before servicing.
 Replace all parts and panels before operating.
 Failure to do so can result in death or electrical shock.



Fire Hazard
 Shut off gas supply line valve before servicing.
 Check all gas line connections and replace all parts and panels before operating.
 Failure to do so can result in explosion, fire or other injury.

1. Turn off gas supply and disconnect power to the range.
2. Open the oven door and remove the racks from inside the oven.
3. Unscrew the lens and bulb from the oven light socket assembly and remove them.

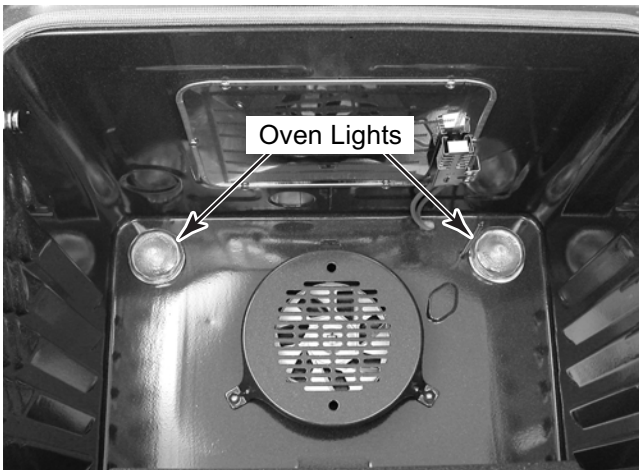

Oven Light Lens

Oven Light Bulb

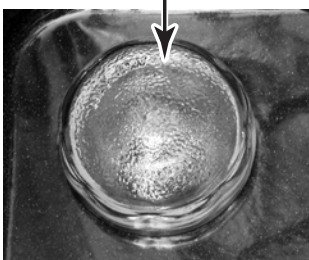

CAUTION: Be careful not to scratch or chip the oven liner paint when you remove the oven light socket in the next step.

4. Use a screwdriver and bend the clips on the oven light socket away from the edges of the liner hole, and pull the socket out of the liner. **NOTE:** If it is too difficult to remove the socket from the front of the oven, you will have to push the socket out from the back of the unit.

Socket Clip



5. Disconnect the wires from the socket terminals.

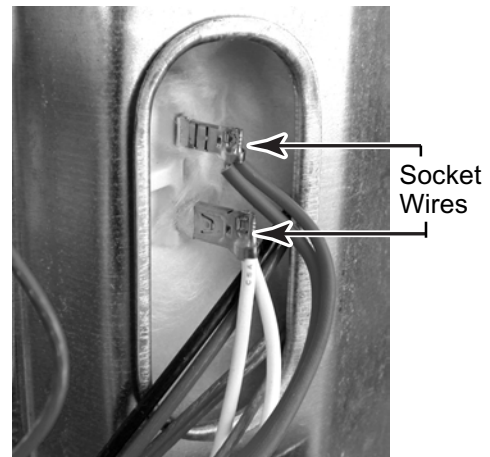

(Viewed From Rear Panel)

REMOVING THE MEAT PROBE JACK

⚠️ WARNING



Electrical Shock Hazard
Disconnect power before servicing.
Replace all parts and panels before operating.
Failure to do so can result in death or electrical shock.



Fire Hazard
Shut off gas supply line valve before servicing.
Check all gas line connections and replace all parts and panels before operating.
Failure to do so can result in explosion, fire or other injury.

1. Turn off gas supply and disconnect power to the range.
2. Pull the range out of its mounting location so that you can access the left side of the unit.
3. Open the oven door and remove the racks from inside the oven.
4. Remove the left side panel (see page 4-22 for the procedure).

Meat Probe Jack

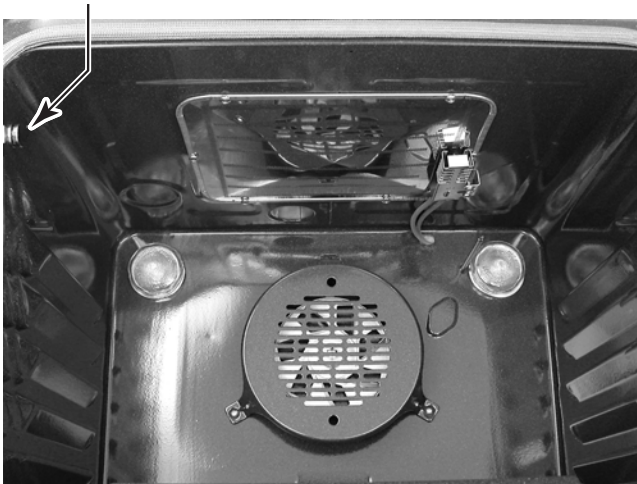

5. Lift the spring-loaded cap on the meat probe jack.

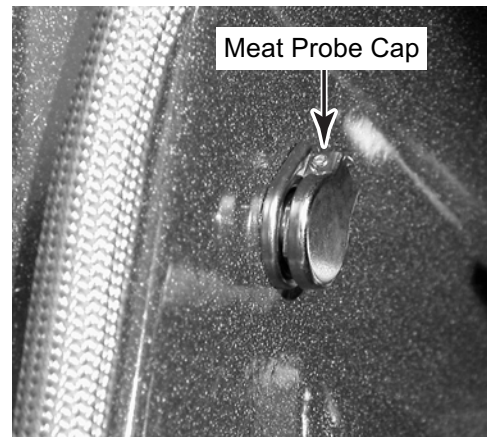

6. Use a 16mm socket and remove the meat probe jack nut and felt washer from the oven liner.

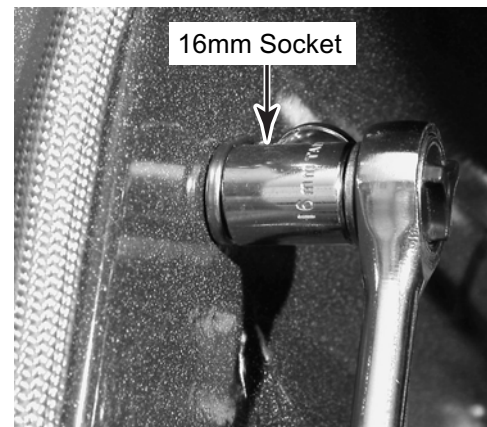

7. Remove the metal sleeve and disconnect the wires from the meat probe jack terminals, then remove the jack from the unit.

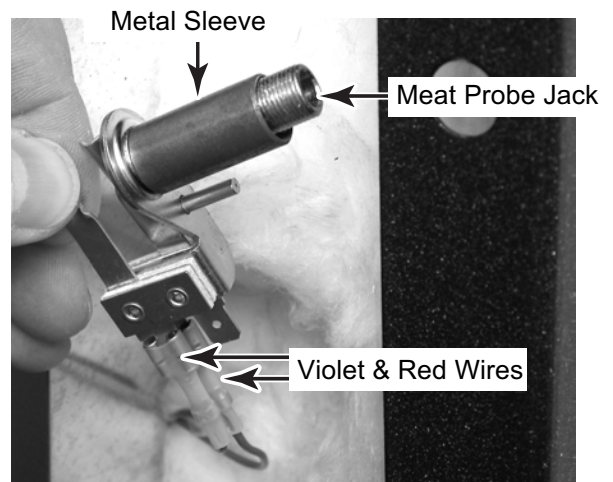

REMOVING THE BROIL BURNER & IGNITOR

!WARNING



Electrical Shock Hazard
Disconnect power before servicing.
Replace all parts and panels before operating.
Failure to do so can result in death or electrical shock.



Fire Hazard
Shut off gas supply line valve before servicing.
Check all gas line connections and replace all parts and panels before operating.
Failure to do so can result in explosion, fire or other injury.

1. Turn off gas supply and disconnect power to the range.
2. Pull the range out of its mounting location so that you can access the rear of the unit.
3. Remove the rear panel (see page 4-5 for the procedure).
4. Open the oven door and remove the racks from inside the oven.

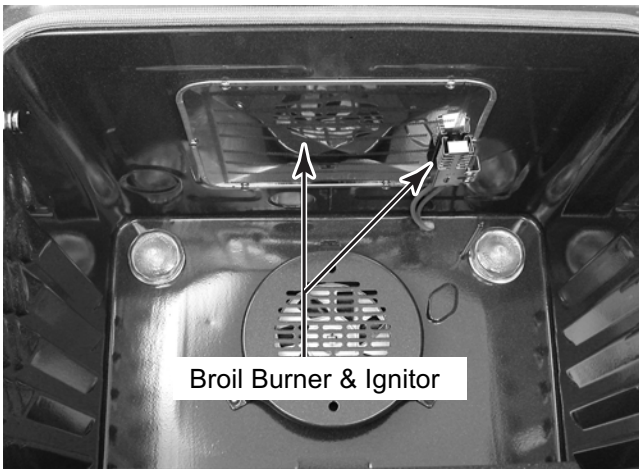

5. **To remove the broil burner ignitor:**
 - a) From inside the oven, remove the two screws from the broil burner ignitor, and slide the ignitor out of the burner bracket (see the inset photo at the top of the next column).

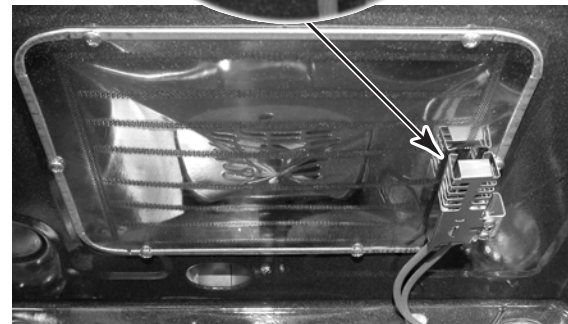
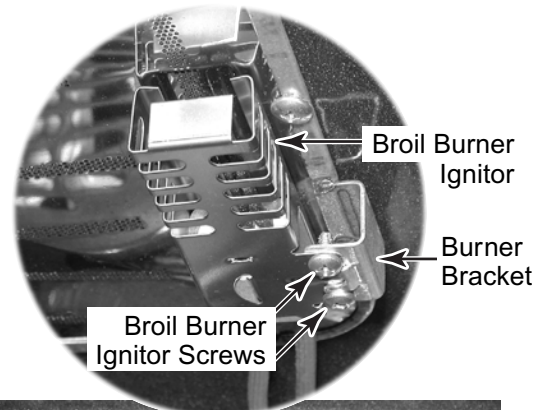

- b) Remove the right side panel (see page 4-22 for the procedure).
- c) Remove the screw from the shield and remove the shield from the unit.

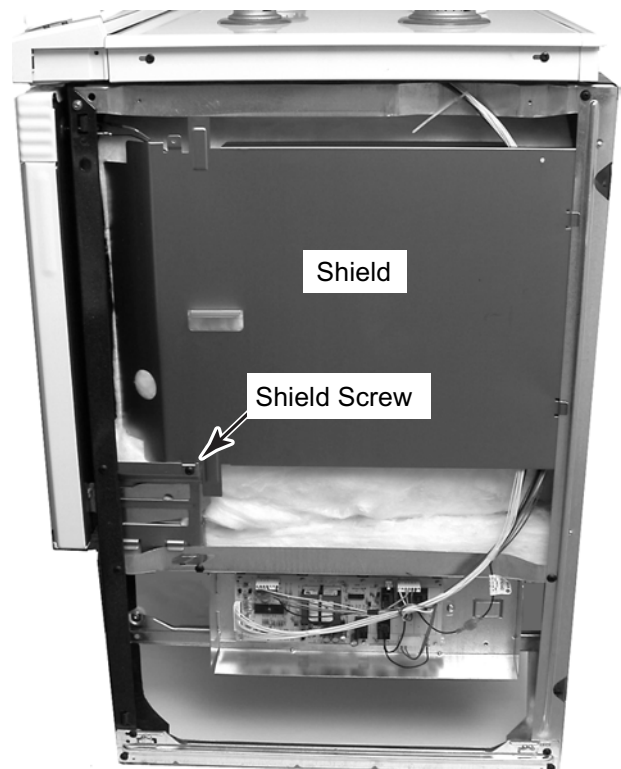

- d) Disconnect the two broil burner ignitor wire connectors, (one on the right side, and the other at the right rear of the unit), from the violet wiring harness connectors.
- e) Pull the ignitor wires out of the unit and remove the broil burner ignitor.

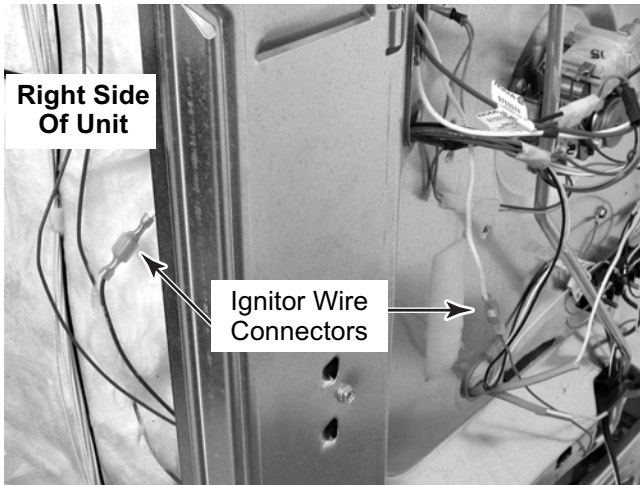

- b) Use a 15/16" open end wrench and loosen the hex nut from the gas connector, then unscrew the nut with your fingers, and remove it from the broil burner bracket.

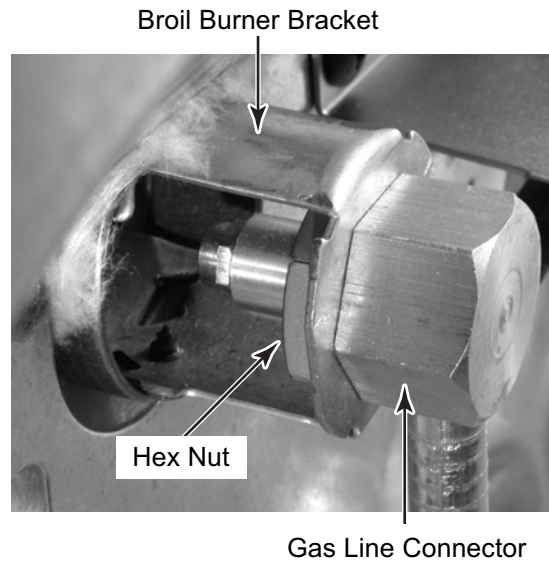

6. To remove the broil burner:

- a) From the rear of the unit, remove the three screws from the broil tube cover and remove the cover.

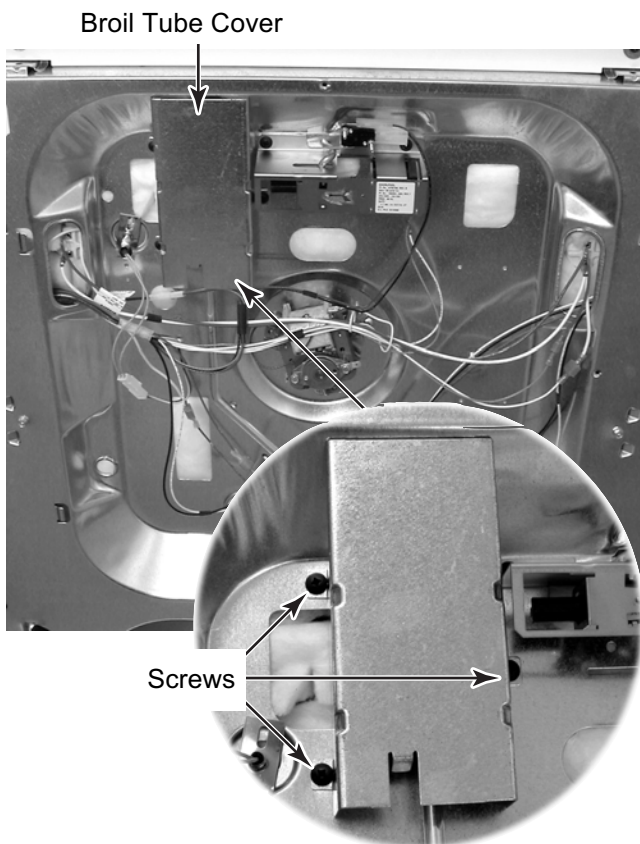

- c) From inside the oven, remove the burner ignitor from the broil burner bracket (see page 4-16 for the procedure).
- d) Remove the six screws and lockwashers from the broil burner.
- e) Pull the broil burner forward so that the air shutter and bracket are free of the oven cavity, and remove it.

Screw & Lockwasher (1 or 6)

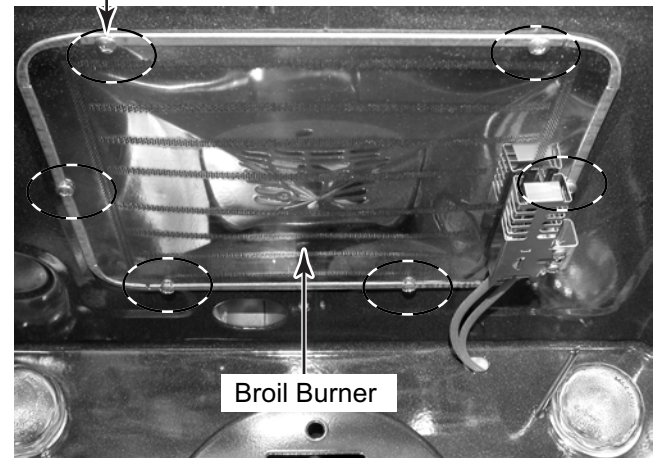

REMOVING THE BAKE BURNER & IGNITOR

! WARNING



Electrical Shock Hazard

Disconnect power before servicing.
 Replace all parts and panels before operating.
 Failure to do so can result in death or electrical shock.



Fire Hazard

Shut off gas supply line valve before servicing.
 Check all gas line connections and replace all parts and panels before operating.
 Failure to do so can result in explosion, fire or other injury.

1. Turn off gas supply and disconnect power to the range.
2. Remove the storage drawer from the unit.
3. Open the oven door and remove the racks from inside the oven.
4. Remove the four screws from the bake burner cover and lift the cover off the flame spreader.



5. Remove the four screws from the flame spreader and remove the spreader.

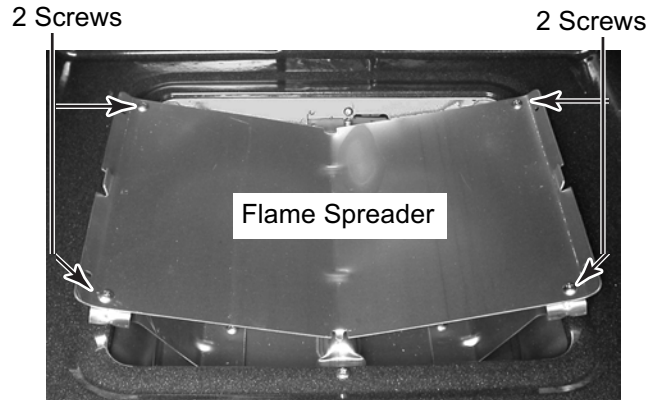

6. To remove the bake burner:
 - a) Remove the two screws from the bake burner ignitor bracket, and remove the bracket and ignitor from the burner.

Bake Burner Ignitor Bracket Screws

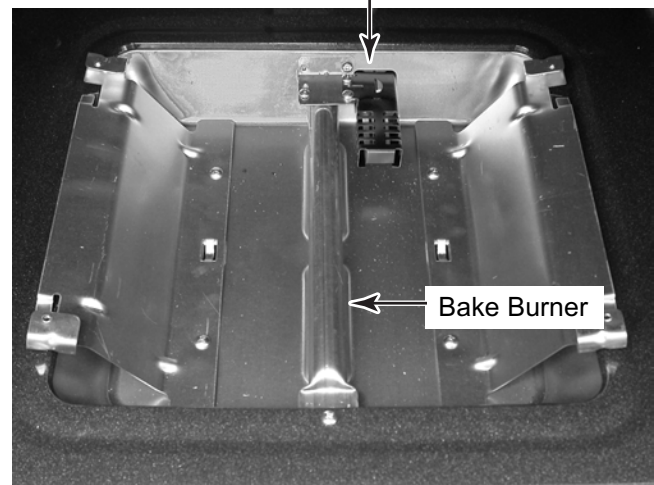
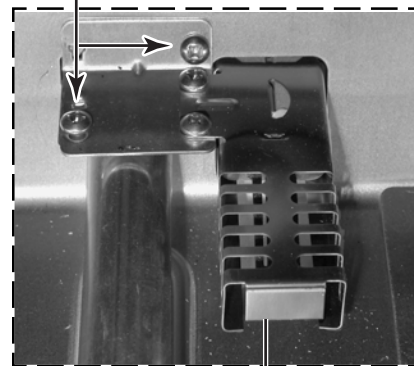

- b) Remove the mounting screw from the gas distribution valve, and the four screws from the gas safety valve (see page 4-21 for the procedure).
- c) Lift the bake burner and pull forward on the gas distribution valve, and the gas safety valve until the orifice is free of the bake burner air shutter.

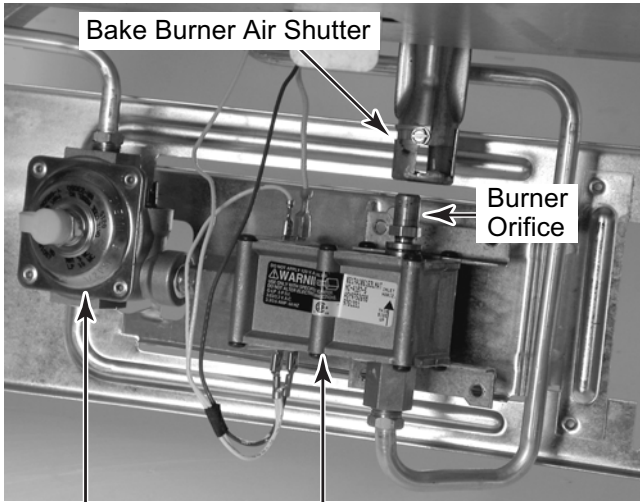

Gas Distribution Valve Safety Valve

- d) Remove the bake burner from the front slot in the liner and remove the burner from the unit.

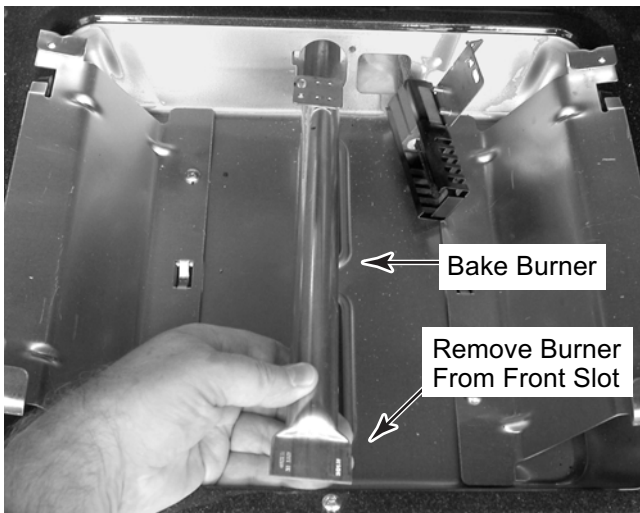

7. **To remove the bake burner ignitor:**

- a) Remove the two screws from the bake burner ignitor and slide it off the burner bracket.
- b) Pull the range out of its mounting location so that you can access the rear of the unit.
- c) Remove the rear panel (see page 4-5 for the procedure).

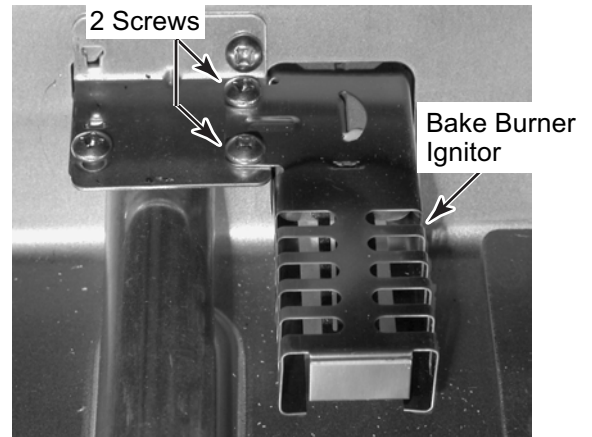

- d) From the rear of the unit, disconnect the bake burner ignitor wires from the red wire harness connector and the gas safety valve.
- e) Pull the ignitor wires through the oven liner and remove the bake burner ignitor.

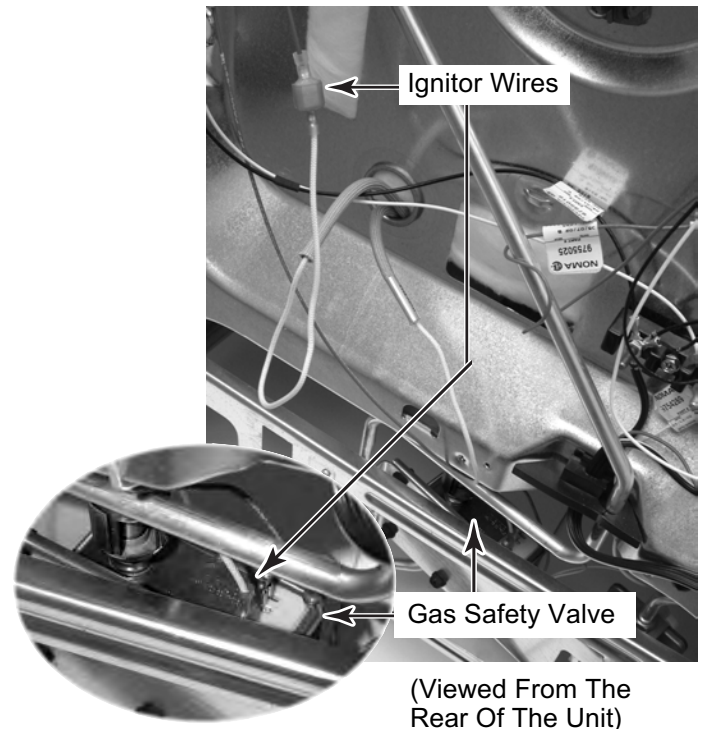

REMOVING THE OVEN TEMPERATURE SENSOR

!WARNING



Electrical Shock Hazard
Disconnect power before servicing.
Replace all parts and panels before operating.
Failure to do so can result in death or electrical shock.



Fire Hazard
Shut off gas supply line valve before servicing.
Check all gas line connections and replace all parts and panels before operating.
Failure to do so can result in explosion, fire or other injury.

1. Turn off gas supply and disconnect power to the range.
2. Pull the range out of its mounting location so that you can access the rear of the unit.

Oven Temperature Sensor

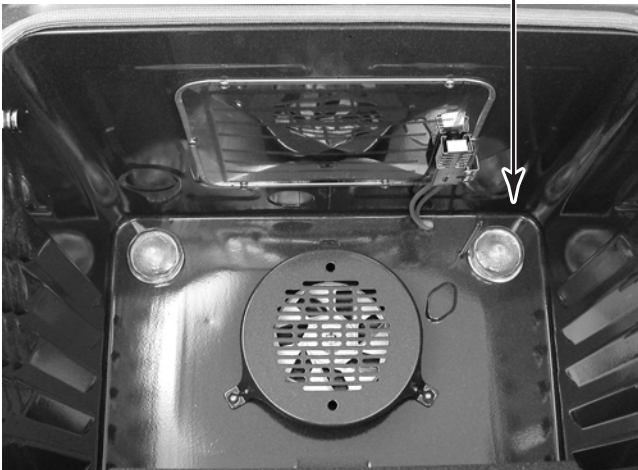

3. Remove the rear panel (see page 4-5 for the procedure).

Oven Temperature Sensor

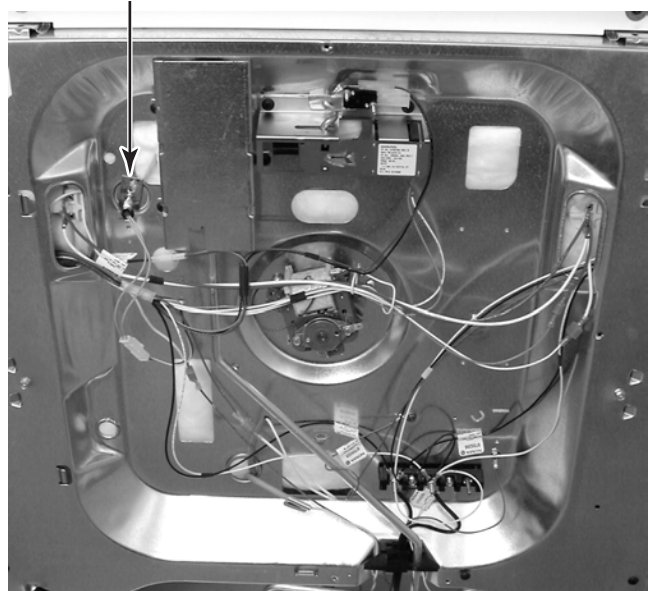

4. Disconnect the oven temperature sensor connector from the wiring harness.
5. Remove the screw from the temperature sensor bracket and remove the sensor.

Oven Temperature Sensor

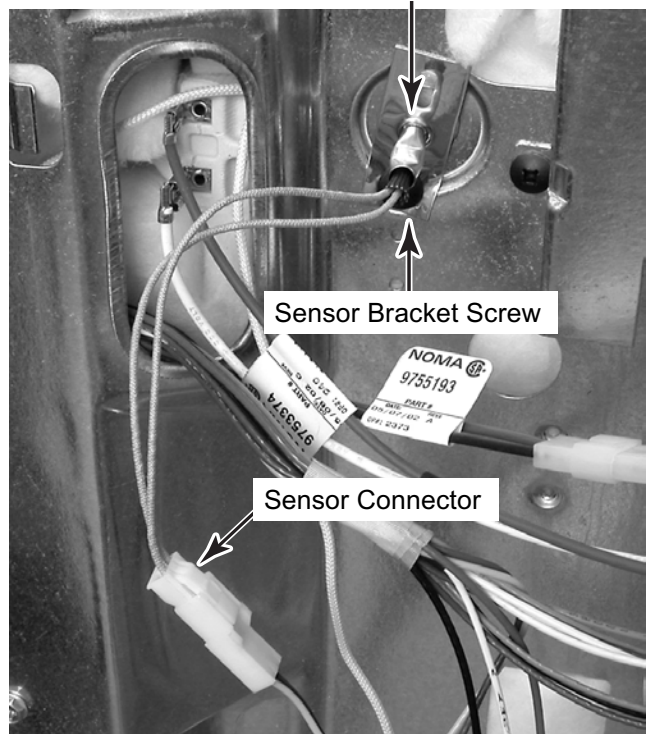

REMOVING THE GAS DISTRIBUTION AND SAFETY VALVES

!WARNING	
	<p>Electrical Shock Hazard Disconnect power before servicing. Replace all parts and panels before operating. Failure to do so can result in death or electrical shock.</p>
	<p>Fire Hazard Shut off gas supply line valve before servicing. Check all gas line connections and replace all parts and panels before operating. Failure to do so can result in explosion, fire or other injury.</p>

1. Turn off gas supply and disconnect power to the range.
2. Remove the storage drawer.

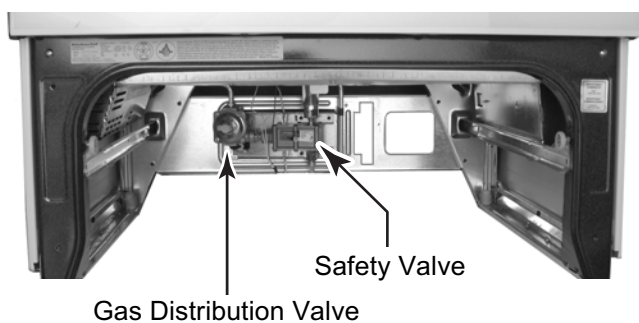

3. From inside the storage drawer area, disconnect the bake and broil wires from the safety valve.
4. Disconnect the gas lines from the gas distribution and safety valves.

Gas Distribution Valve Line Bake Safety Valve Wires

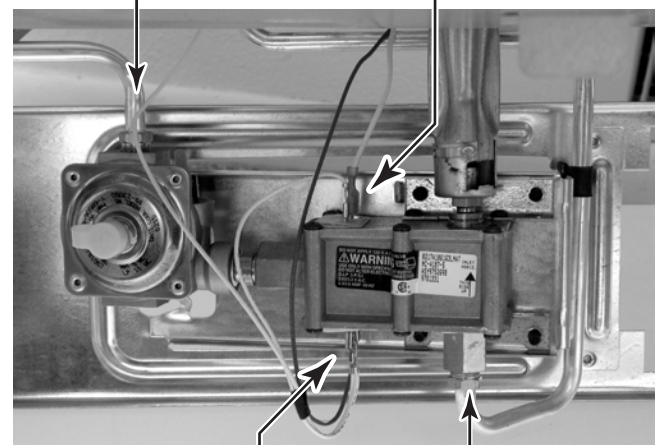

Broil Safety Valve Wires Safety Valve Gas Line

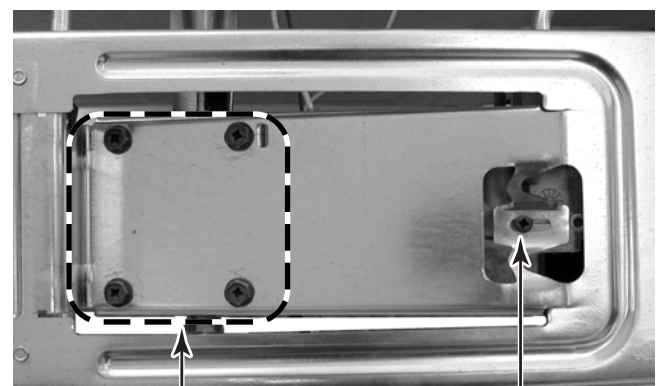

5. Remove the mounting screws from the gas distribution and safety valves. **NOTE:** The gas distribution and safety valves are replaced as an assembly. They are not intended to be replaced separately.



Safety Valve Screws Gas Distribution Valve Screw

(Viewed From The Rear Of The Unit)

REMOVING A SIDE PANEL

!WARNING	
	<p style="text-align: center;">Electrical Shock Hazard</p> <p>Disconnect power before servicing.</p> <p>Replace all parts and panels before operating.</p> <p>Failure to do so can result in death or electrical shock.</p>
	<p style="text-align: center;">Fire Hazard</p> <p>Shut off gas supply line valve before servicing.</p> <p>Check all gas line connections and replace all parts and panels before operating.</p> <p>Failure to do so can result in explosion, fire or other injury.</p>

1. Turn off gas supply and disconnect power to the range.
2. Pull the range out of its mounting location so that you can access the rear of the unit.
3. Pull the storage drawer out as far as it will go.
4. Remove the two rear screws from the side panel.

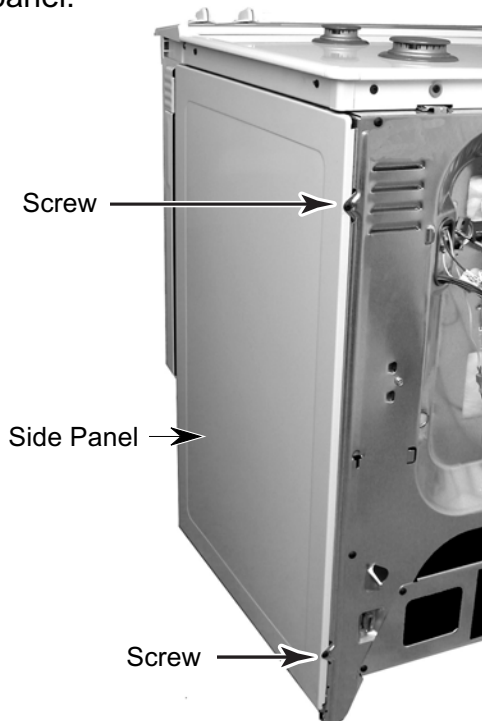

5. From the rear of the unit, reach inside and remove the screw from the bottom of the side panel.

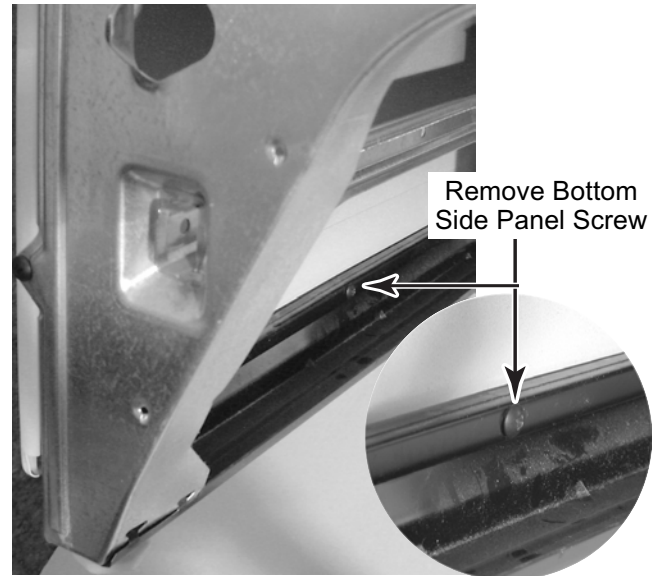

6. Slide the side panel forward and unhook the front edge, then tilt the top of the side panel out, and lift the panel from the unit.

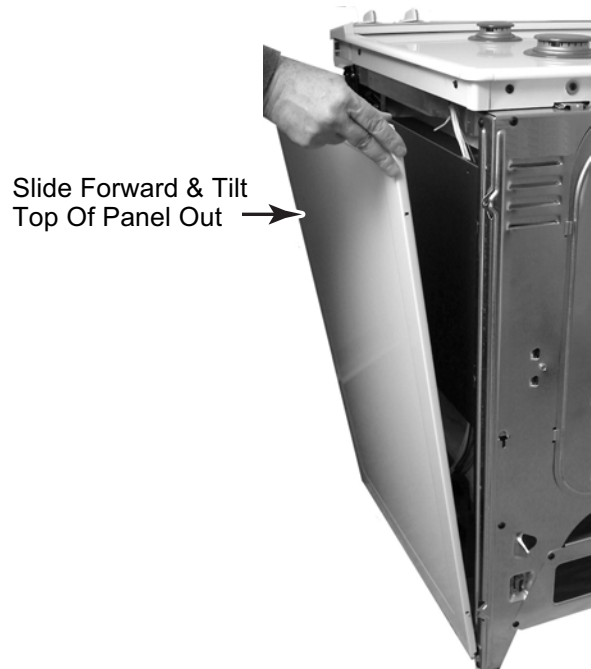

NOTE: When reinstalling the side panel, set the bottom edge on the rail, hook the front edge at the top and bottom, and install the two rear screws; then install the bottom screw from inside the rear of the unit.

REMOVING THE DOOR SWITCH & POWER SUPPLY BOARD

!WARNING	
	<p>Electrical Shock Hazard</p> <p>Disconnect power before servicing.</p> <p>Replace all parts and panels before operating.</p> <p>Failure to do so can result in death or electrical shock.</p>
	<p>Fire Hazard</p> <p>Shut off gas supply line valve before servicing.</p> <p>Check all gas line connections and replace all parts and panels before operating.</p> <p>Failure to do so can result in explosion, fire or other injury.</p>

1. Turn off gas supply and disconnect power to the range.
2. Remove the right side panel (see page 4-22 for the procedure).



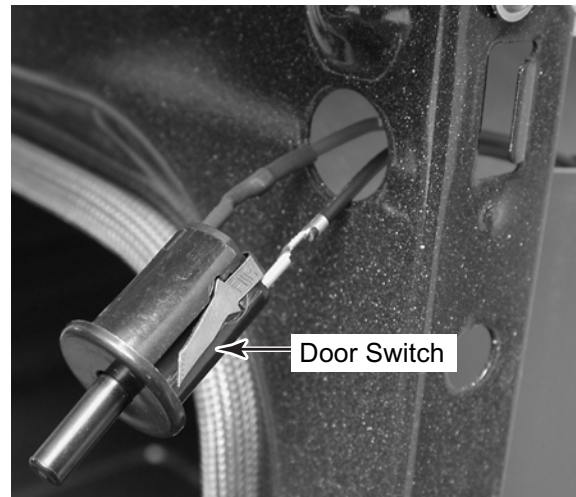

3. To remove the door switch:
 - a) Press in on the locking arms and push the door switch out of the unit.
 - b) Disconnect the wires from the terminals.

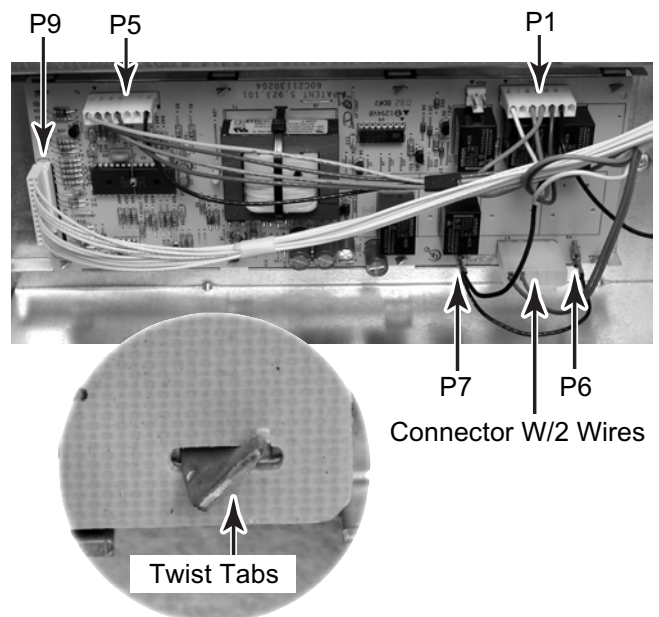

4. To remove the power supply board:
 - a) Disconnect the connectors from P9, P5, P1, P6, P7, and the connector with two wires for terminals P2 and P8.
 - b) Twist and straighten the tabs on the power supply bracket until they align with the board slots, and remove the board from the bracket.



REMOVING THE SPARK MODULE AND THE COOLING FAN MOTOR

!WARNING	
	<p style="text-align: center;">Electrical Shock Hazard</p> <p>Disconnect power before servicing. Replace all parts and panels before operating. Failure to do so can result in death or electrical shock.</p>
	<p style="text-align: center;">Fire Hazard</p> <p>Shut off gas supply line valve before servicing. Check all gas line connections and replace all parts and panels before operating. Failure to do so can result in explosion, fire or other injury.</p>

1. Turn off gas supply and disconnect power to the range.
2. Open the oven door and remove the racks from inside the oven.
3. Pull the range out of its mounting location so that you can access the rear of the unit.
4. Remove the left side panel (see page 4-22 for the procedure).

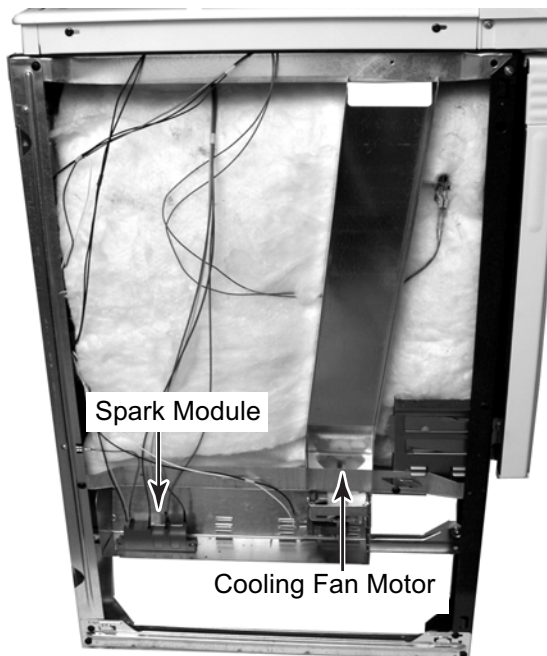

5. To remove the spark module:
 - a) Disconnect the wire connectors from the module terminals.
 - b) Remove the mounting screw, slide the module out from under the tab, and remove it from the housing.

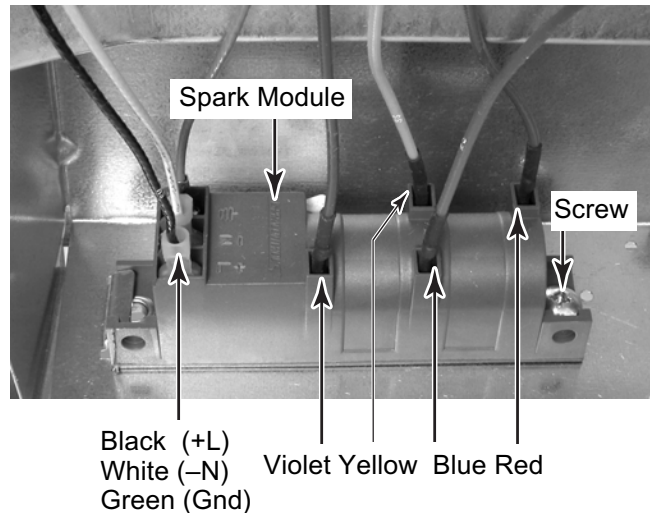

6. To remove the cooling fan motor:
 - a) Disconnect the wire connectors from the cooling fan motor terminals.

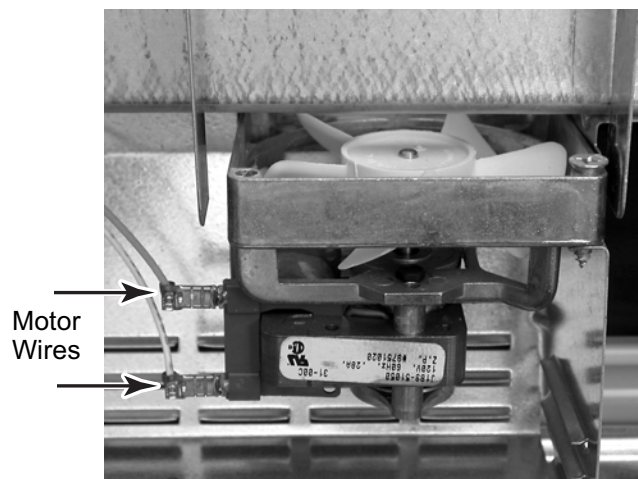

- b) Remove the storage drawer from the front of the unit.
- c) From the storage drawer area, remove the front housing screw and loosen the other two screws.
- d) Slide two of the three motor housing brackets out from under the two screws, and the other bracket out of the slot in the chassis, and remove the housing.

Remove This Screw Loosen These Screws

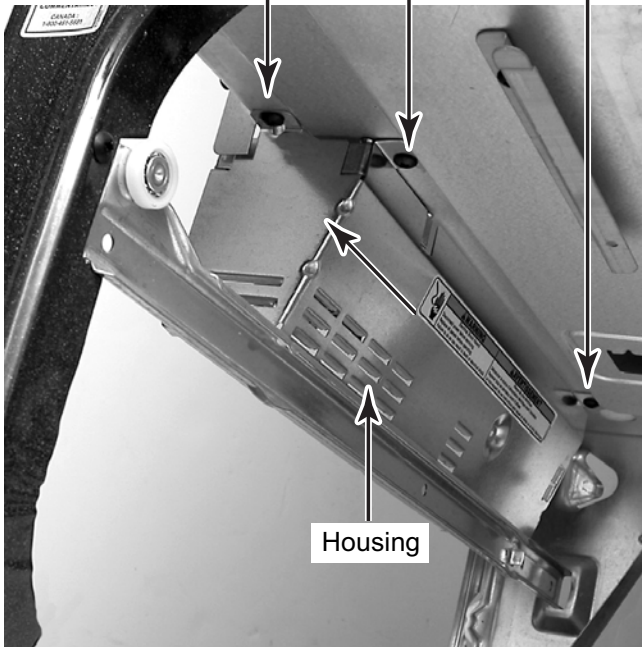

- e) Remove the three cooling fan motor mounting screws and remove the motor from the housing.

Cooling Fan Motor Screws

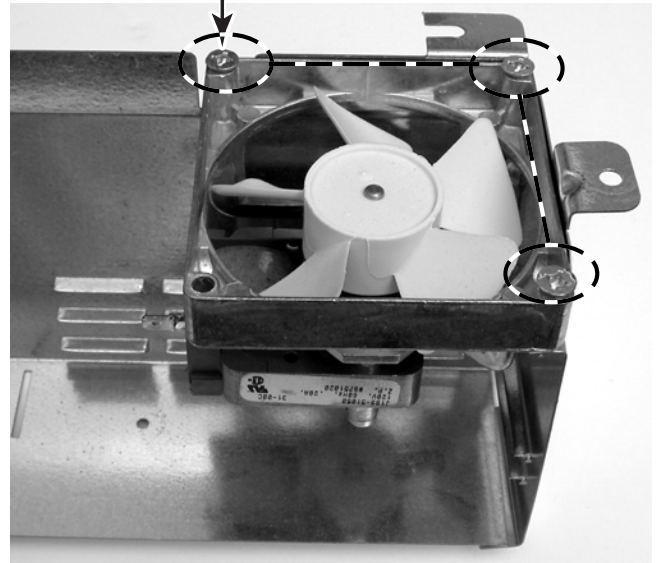

REMOVING THE DECORATIVE GLASS, THE OVEN DOOR HANDLE, THE HINGES, AND THE OVEN DOOR GLASS

1. Remove the oven door from the range (see page 4-28 for the procedure).
2. Place the oven door on a padded work surface with the decorative glass and handle facing up and the bottom edge facing the front.
3. **To remove the decorative glass:**
 - a) Remove the four decorative glass retainer screws, and remove the retainer and two side trims.
 - b) Lift the decorative glass off the door.



4. **To remove the door handle:**
 - a) Lift the air vent and handle off the door.

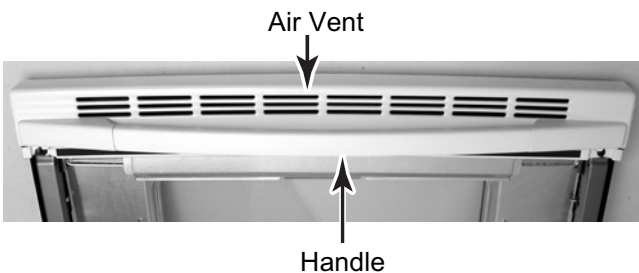

- b) Remove the four handle screws (two on each side) from the air vent and remove the handle.



5. **To remove a hinge:**
 - a) Remove the two bottom screws from the hinge you are servicing. NOTE: If you are removing both hinges, remove the steam deflector. Note how the deflector is mounted between the two hinges.
 - b) Remove the bracket and retainer screw from the top of the hinge.

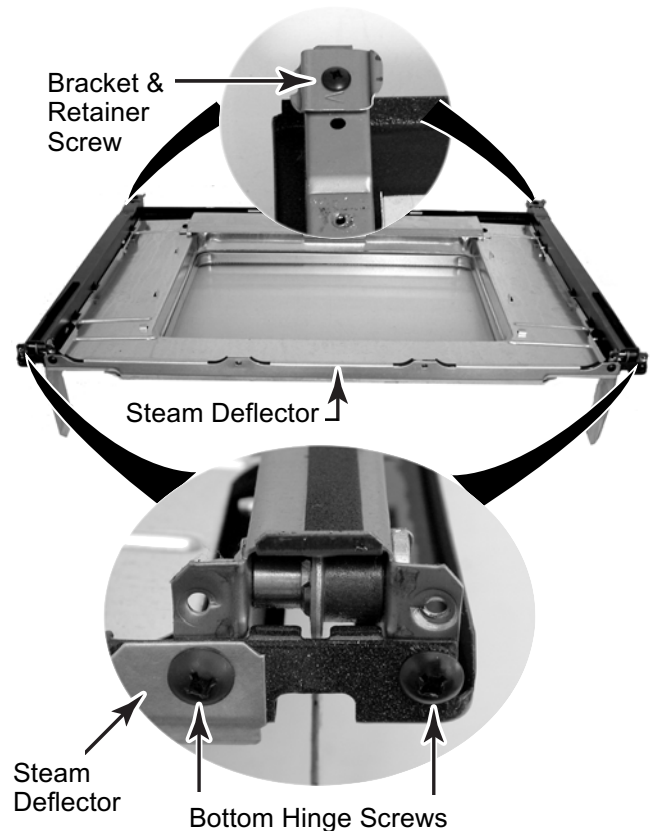

- c) Remove the bracket, retainer, and hinge from the door.

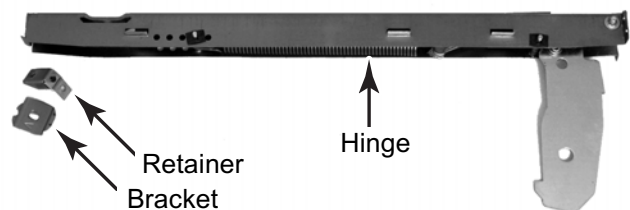

6. To remove the inner and outer oven door glass:

a) Lift the insulation retaining plate off the door.

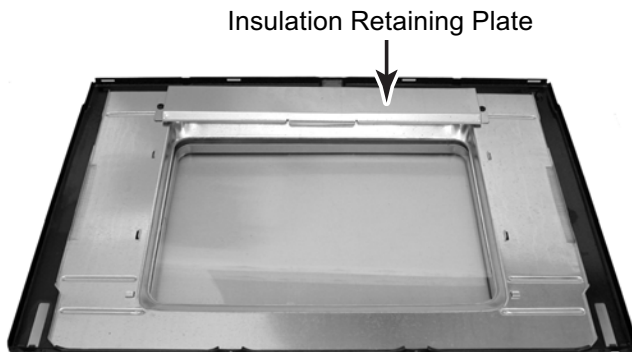

b) Remove the insulation and outer oven glass from the door.

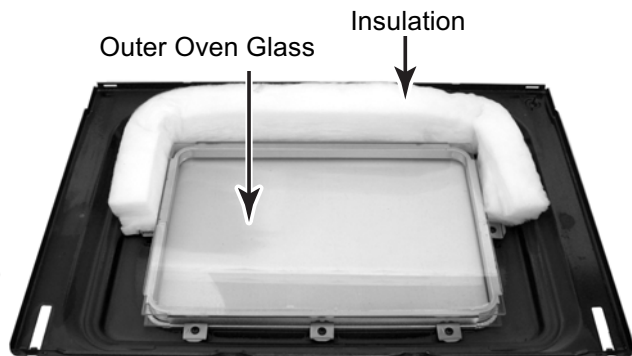

c) Remove the screws from the seven oven glass spacer retaining brackets and remove the brackets. NOTE: When you reinstall the brackets, make sure that you position the arrows on the brackets towards the glass spacer.

d) Lift the glass spacer and the inner oven glass off the door.

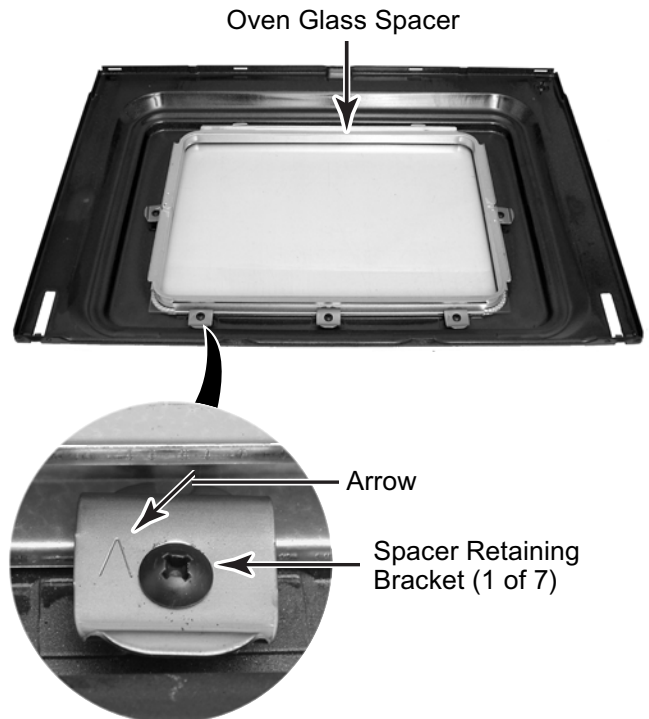

e) If you are replacing the rope insulation, remove it from around the oven glass opening in the door.

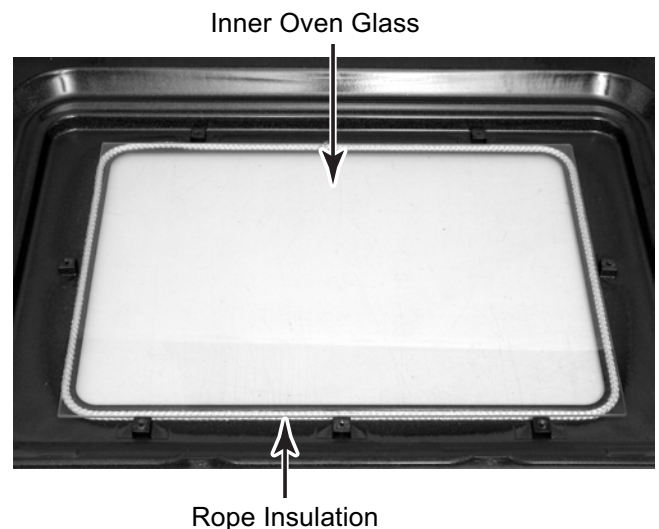

REMOVING THE OVEN DOOR

1. To remove the oven door, open the door to its first stop.
2. Grasp the sides of the door, lift it slightly, and pull the door forward until the hinge hangers are **partially** out of the slots in the chassis. Do not completely remove the hinge hangers from the slots, since there will be spring tension on them.





3. Reposition the angle of the door to its vertical position to remove the spring tension on the hinge hangers, then pull the hangers the rest of the way out of the chassis slots.



To reinstall the oven door:

1. Grasp the sides of the door and insert the hinge hangers into the hinge slots. Lift the door slightly and push in at the bottom until the hangers are fully installed in the unit. NOTE: If the hinge hangers are not seated properly, the door will not close tightly and may be off-center. To seat the hinge hangers, keep the door vertical, then lift it slightly, and push in on the bottom until the hangers are fully seated.
2. Open and close the oven door to make sure that it operates and seals properly.

REMOVING THE OVEN DOOR GASKET

!WARNING	
	Electrical Shock Hazard Disconnect power before servicing. Replace all parts and panels before operating. Failure to do so can result in death or electrical shock.
	Fire Hazard Shut off gas supply line valve before servicing. Check all gas line connections and replace all parts and panels before operating. Failure to do so can result in explosion, fire or other injury.

1. Turn off gas supply and disconnect power to the range.
2. Pull the range out of its mounting location so that you can access the rear of the unit.
3. Loosen the two oven liner screws so that the inside of the hex-head skirt is approximately 1/2" from the chassis.



4. Pull the oven liner forward to loosen the oven door gasket from the front of the unit.
5. Starting at one end, pull the gasket out of the liner hole, and remove it from around the liner and the second hole.



Pull Door Gasket Out Of Hole And Remove From Liner

REASSEMBLY NOTE: After the door gasket is installed, make sure that it is even along the surface of the door when the door is closed.

— NOTES —

COMPONENT TESTING

Before testing any of the components, perform the following checks:

- The most common cause for control failure is corrosion on connectors. Therefore, disconnecting and reconnecting wires will be necessary throughout test procedures.
- All tests/checks should be made with a VOM or DVM having a sensitivity of 20,000 ohms-per-volt DC, or greater.
- Check all connections before replacing components, looking for broken or loose wires, failed terminals, or wires not pressed into connectors far enough.
- Resistance checks must be made with power cord unplugged from outlet, and with wiring harness or connectors disconnected.

	⚠ WARNING
	Electrical Shock Hazard Disconnect power before servicing. Replace all parts and panels before operating. Failure to do so can result in death or electrical shock.

BIMETAL SWITCHES

Refer to pages 4-2 and 4-8 for the procedure for servicing the bimetal switches.

1. Turn off gas supply and disconnect power to the range.
2. Disconnect one of the wires from the bimetal switch under test.
3. Set the ohmmeter to the R x 1 scale.
4. **For the ambient bimetal switch (N.C.),** touch the ohmmeter test leads to the terminals. The meter should indicate continuity (0 Ω).
5. **For the cooling fan bimetal switch (N.O.),** touch the ohmmeter test leads to the terminals. The meter should indicate an open circuit (infinite).
6. **For the cooktop bimetal switch (N.C.),** touch the ohmmeter test leads to the terminals. The meter should indicate continuity (0 Ω).

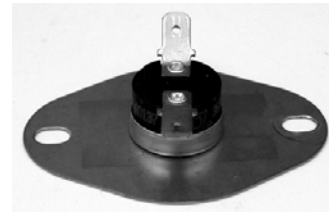

Ambient Bimetal Switch (N.C.)
Opens @ 96°C (205°F)
Resets @ 74°C (165°F)

Cooling Fan Bimetal Switch (N.O.)
Resets @ 70°C (158°F)
Closes @ 60°C (140°F)



⚠ WARNING

Electrical Shock Hazard

Disconnect power before servicing.

Replace all parts and panels before operating.

Failure to do so can result in death or electrical shock.

IGNITION SWITCHES

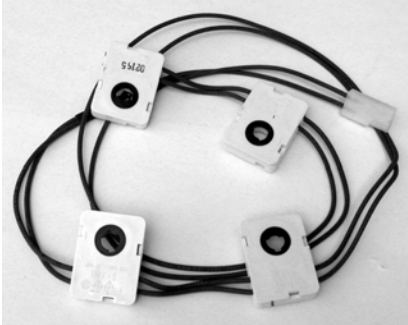

NOTE: The ignition switches are connected to each other in a parallel circuit so that if one switch fails, the others will still operate. To check each of the ignition switches for proper operation, perform the following steps.

Refer to page 4-2 for the procedure for servicing the ignition switches.

1. Turn off gas supply and disconnect power to the range.
2. Remove the control panel and access the ignition switch connector (see page 4-2 for the procedure).
3. Reinstall the knobs on the valve stems.

4. Disconnect the ignition switch connector from the wire harness.
5. Set the ohmmeter to the R x 1 scale.
6. Connect the ohmmeter test leads to the pins of the spark module connector.
7. Press and turn one of the gas valve knobs to the LITE position. At that point, the switch should close, and the meter should indicate continuity.
8. Continue to turn the knob away from the LITE position. The switch should open, and the meter should indicate an open (infinite ∞) circuit.
9. Repeat steps 7 and 8 for the other ignition switches. If the readings are not as stated, replace the entire ignition switch assembly (they are supplied as an assembly and cannot be changed individually).



⚠ WARNING

Electrical Shock Hazard

Disconnect power before servicing.

Replace all parts and panels before operating.

Failure to do so can result in death or electrical shock.

DOOR SWITCH (N.O.)



Refer to page 4-23 for the procedure for servicing the door switch.

1. Turn off gas supply and disconnect power to the range.
2. Disconnect one of the wires from the door switch.
3. Set the ohmmeter to the R x 1 scale.
4. Touch the ohmmeter test leads to the door switch terminals. The meter should indicate an open circuit (infinite).
5. Press the actuator button and the meter should indicate continuity (0 Ω).

DOOR LATCH ASSEMBLY (N.O.)



Door Latch Solenoid



Door Latch Switch

Refer to page 4-5 for the procedure for servicing the door latch assembly.

1. Turn off gas supply and disconnect power to the range.
2. Disconnect one of the wires from the door latch assembly component under test.
3. Set the ohmmeter to the R x 1 scale.
4. **To test the solenoid**, touch the ohmmeter test leads to the terminals. The meter should indicate less than 1 Ω .
5. **To test the door latch switch:**
 - a) Touch the ohmmeter test leads to the COM and N.O. terminals. The meter should indicate an open circuit (infinite).
 - b) With the ohmmeter leads connected as stated in the previous step, press the switch actuator. The meter should indicate continuity (0 Ω).



⚠️ WARNING

Electrical Shock Hazard

Disconnect power before servicing.

Replace all parts and panels before operating.

Failure to do so can result in death or electrical shock.

CONVECTION FAN MOTOR

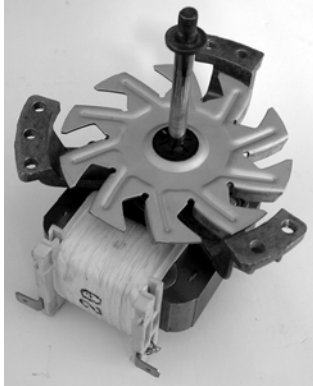

Refer to page 4-12 for the procedure for servicing the convection fan motor.

1. Turn off gas supply and disconnect power to the range.
2. Disconnect one of the wires from the convection fan motor.
3. Set the ohmmeter to the R x 1 scale.
4. Touch the ohmmeter test leads to the convection fan motor terminals. The meter should indicate between 9 and 13 Ω .

SAFETY VALVE

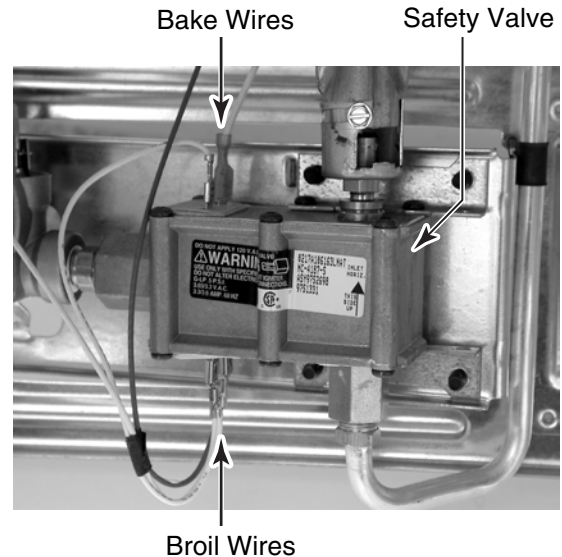

Refer to page 4-21 for the procedure for servicing the safety valve. NOTE: The gas distribution valve and the safety valve are serviced as an assembly, and not individually.

1. Turn off gas supply and disconnect power to the range.
2. Disconnect one of the wires from the bake or broil safety valve terminals.
3. Set the ohmmeter to the R x 1 scale.
4. Touch the ohmmeter test leads to the bake or broil safety valve terminals. The meter should indicate between 1 and 2 Ω .



⚠️ WARNING

Electrical Shock Hazard

Disconnect power before servicing.
Replace all parts and panels before operating.
Failure to do so can result in death or electrical shock.

GAS DISTRIBUTION VALVE

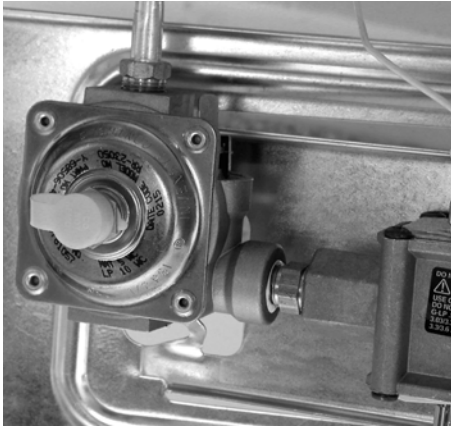

Refer to page 4-21 for the procedure for servicing the gas distribution valve. **NOTE:** The gas distribution valve and the safety valve are serviced as an assembly, and not individually.

The gas distribution valve must be checked at a minimum of 1-inch water column above the set pressure. If the readings are not within the range shown, the valve is defective and should be replaced. The inlet pressure to the valve should be as follows for operation:

Natural Gas—Set the pressure @ 5-inches, maximum pressure = 14-inches.

L.P. Gas—Set the pressure @ 11-inches, maximum pressure = 14-inches.

Line Pressure Test above 1/2 lb psi (gauge):

The range and its individual shutoff valve must be disconnected from the gas supply piping system during any pressure testing at test pressures greater than 1/2 psig (3.5 kPa).

Line Pressure Test @ 1/2 lb psi (gauge):

The range and its individual shutoff valve must be disconnected from the gas supply piping system during any pressure testing at test pressures equal to or less than 1/2 psig (3.5 kPa).

OVEN TEMPERATURE SENSOR



Refer to page 4-20 for the procedure for servicing the oven temperature sensor.

1. Turn off gas supply and disconnect power to the range.
2. Disconnect the oven temperature sensor connector.
3. Set the ohmmeter to the R x 1K scale.
4. Touch the ohmmeter test leads to the oven temperature sensor connector pins. The meter should indicate as follows:

1654 Ω at 177°C (350°F)

1000 Ω at 0°C (32°F)



⚠ WARNING

Electrical Shock Hazard

Disconnect power before servicing.

Replace all parts and panels before operating.

Failure to do so can result in death or electrical shock.

COOLING FAN MOTOR

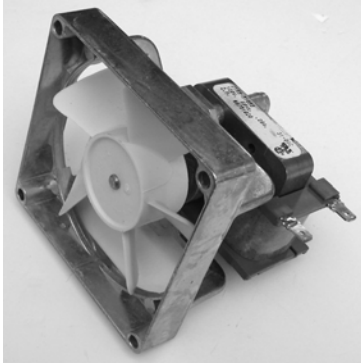

Refer to page 4-24 for the procedure for servicing the cooling fan motor.

1. Turn off gas supply and disconnect power to the range.
2. Disconnect one of the wires from the cooling fan motor.
3. Set the ohmmeter to the R x 1 scale.
4. Touch the ohmmeter test leads to the cooling fan motor terminals. The meter should indicate between 55 and 75 Ω .

BROIL & BAKE IGNITORS

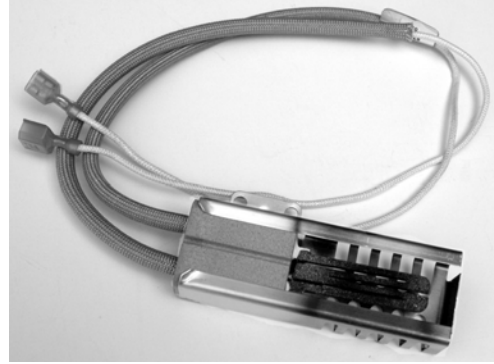

Refer to pages 4-16 and 4-18 for the procedures for servicing the broil and bake ignitors.

1. Turn off gas supply and disconnect power to the range.
2. Disconnect one of the broil or bake ignitor wires from the wire harness.
3. Set the ohmmeter to the R x 1 scale.
4. Touch the ohmmeter test leads to the ignitor terminals. The meter should indicate between 85 and 95 Ω .



⚠ WARNING

Electrical Shock Hazard

Disconnect power before servicing.

Replace all parts and panels before operating.

Failure to do so can result in death or electrical shock.

GAS VALVE



Refer to page 4-2 for the procedure for servicing the gas valves.

To test a gas valve, use a low-pressure manometer, and measure the inlet and outlet pressure across the valve. There should be no pressure drop. If there is a pressure drop, the valve should be replaced.

— NOTES —

DIAGNOSIS & TROUBLESHOOTING

DIAGNOSIS

FAILURE/ERROR DISPLAY CODES

- All diagnoses of this range must begin with a normal check of the line voltage, blown fuses, and failed components.
- All units that have failed during the first few days of use should be checked for loose connections, or miswiring.
- All checks should be made with a meter having a sensitivity of 20,000 ohms-per-volt, or greater.

FAULT NAME	FAULT NAME IN SOFTWARE	FAULT DESCRIPTION	FIELD SERVICE ACTION
F0 E0	No fault found.	No fault found.	No action required.
F1 E2	Power board communication.	Lost communication with power board.	Check communication between power board and display board.
F1 E3	Configuration mis-match.	Configuration jumper change; freestand, electric switches or P3 pins 3 to 7 changed since power up.	See Page 6-2. See Jumper Table on Page 7-1.
F1 E4	Oven sensor calibration.	Oven sensor not calibrated.	Run calibration routine.
F1 E5	Meat probe calibration.	Meat probe not calibrated.	Run calibration routine.
F1 E6	Display board.	Display board EPROM access.	Replace display board.
F1 E7	Power board E2.	Power board EPROM access.	Replace power board.
F1 E8	Power board supply lift.	Improper keypad feeding.	Replace power board.
F1 E9	Keyboard gain.	Unstable keyboard gain.	Replace display board.
F1 EA	Stack warning.	Exceeded stack warning level.	1. Reset power. 2. If problem persists, replace power board.
F2 E0	Keypad disconnect.	User is cleaning too long or keypad is disconnected.	1. Check keypad connections. 2. If problem persists, clean switch surface.
F2 E1	Cancel key.	Cancel key invalid.	Needs surface cleaning.
F2 E3	Keypad spill.	Key held down too long or keyboard short or spill on switch surface.	Needs surface cleaning.
F3 E0	Open oven sensor.	Oven sensor open.	Replace oven sensor.
F3 E3	Shorted oven sensor.	Shorted oven sensor.	Replace oven sensor.
F3 E4	Oven temperature too high.	Oven temperature too high (runaway).	Replace oven sensor, or control.
F4 E0	Shorted meat probe.	Meat probe shorted (less than 1500 ohms).	Replace meat probe.
F5 E1	Self clean latch.	Self clean latch not locking.	Check latch system.
F5 E5	Clean temperature.	Self clean temperature not achieved after 30 minutes.	Check door hinge and door seal gasket.
F5 E7	Clean unlatch.	Door unlocked but will not unlatch.	Check door switch, latch switch, and rod mechanism.
F7 E0	Latch switch.	Invalid latch switch reading.	Check latch switch.
F7 E1	Door switch.	Invalid door switch reading.	Check door switch.
PF		Power Failure (Not a Failure Mode)	Push CANCEL. (Do not replace control.)

FAULT ERROR CODE CHARTS

FAULT ERROR: F1 E3				
NOTE: Make sure harness to P1 connector is correctly installed per wiring diagram before performing the following steps:				
STEP 1	Power off and wait 5 seconds.			
STEP 2	Power on and wait 5 seconds.			
STEP 3	Press the following keys:			
	<table border="1"> <thead> <tr> <th>CONVECTION</th> <th>NON-CONVECTION</th> </tr> </thead> <tbody> <tr> <td> CONV. BROIL CLEAN BAKED GOODS 1 9 0 TIMER SET </td> <td> CLEAN STOP TIME 0 OVEN LIGHT 1 </td> </tr> </tbody> </table>	CONVECTION	NON-CONVECTION	CONV. BROIL CLEAN BAKED GOODS 1 9 0 TIMER SET
CONVECTION	NON-CONVECTION			
CONV. BROIL CLEAN BAKED GOODS 1 9 0 TIMER SET	CLEAN STOP TIME 0 OVEN LIGHT 1			
STEP 4	Press START.			
STEP 5	Make sure Timer ID is the same as the oven.			
STEP 6	Press CANCEL to exit.			

FAULT CODE	FIELD SERVICE MEANING
F1	Control
F2	Keypad Assembly
F3	Temp. Sensor
F4	Meat Probe
F5	Input Switches during clean (door or latch)
F7	Input Switches all modes except clean (door or latch)

TROUBLESHOOTING CHART

PROBLEM	POSSIBLE CAUSE	SOLUTION
Oven will not operate.	Electronic oven control is not set properly. A delay start has been programmed.	Reset the oven control (see the Use & Care Guide for instructions describing the function you are operating). Wait for the start time to be reached.
Burner fails to light.	Range is not plugged in. A household fuse or circuit breaker has opened. Burner ports are clogged.	Plug power cord into a live AC outlet. Replace fuse or reset the breaker. Clean burner ports with straight pin.
Burner flames are uneven.	Burner ports are clogged.	Clean burner ports with straight pin.
Burner flames lift off ports, are yellow, or are noisy when turned off.	The air-to-gas mixture is incorrect.	Adjust air shutters for bake or broil burners. Top burner ports are clogged. Clean or replace burner.
Burner makes “popping” noise when on.	Burner is wet.	Allow burner to dry.
Burners spark.	It is normal for all four burners to spark briefly when: <ul style="list-style-type: none"> • A draft is blowing on the burners. • A very large pot on burner causes flame to be unstable. • The burner is turned on but has not ignited. Continuous sparking may be caused when: <ul style="list-style-type: none"> • A switch contact is wet. • There is a faulty spark module. • The wall outlet wiring is not correct. 	Allow switch to dry. Replace the spark module. Rewire wall outlet.

PROBLEM	POSSIBLE CAUSE	SOLUTION
Control knob will not turn.	Press in on the knob before turning.	If knob is still hard to turn, replace the gas valve.
The self-clean cycle will not operate.	A delay start time has been programmed. The cooling fan is not running.	Wait for the start time to be reached. Check the cooling fan wiring. Test the control panel shutdown switch. Replace the motor.
"PF" shows on the display.	There has been a power failure.	Reset the clock.
A failure code (E3, F1, etc.) is showing on the display.	Press the CANCEL/OFF keypad.	If the code does not disappear, refer to page 6-1, and identify the cause of the error message to help you correct the problem.
The keypads do not operate.	The Control Lock has been set.	Press and hold the Control Lock keypad for 5-seconds to unlock the keypads. The range is not properly grounded.

END OF SERVICE TEST SEQUENCE

After each service is completed, the following test should be performed to ensure proper function on all feature modes.

1. Connect power to the range.

2. Set the Power to On and wait until “Control Lock” clears in the display, and “PF” appears (this will take approximately 10 seconds). Within 1 minute from when “PF” appears in the display, perform the following steps in the sequence shown.

For Convection Units:

1. Press CONVECTION BROIL.
2. Press CLEAN.
3. Press BAKED GOODS.
4. Press STOP TIME.
5. Press 1.
6. Press 9.
7. Press TIMER SET-START.
The clock display will indicate “6AS” and one of the following:
 - “hb-FS” (for hidden bake freestanding units).
 - “Eb-FS” (for exposed bake freestanding units).
 - “hb-SI” (for hidden bake slide-in units).
 - “Eb-SI” (for exposed bake slide-in units).
8. Keep pressing START until the control scrolls through all of the features. This will confirm the proper function for each feature.

For Non-Convection Units:

1. Press CLEAN.
2. Press STOP TIME.
3. Press 0.
4. Press OVEN LIGHT.
5. Press 1.
6. Press START.
7. Keep pressing START until the control scrolls through all of the features. This will confirm the proper function for each feature.

OVEN TEMPERATURE CALIBRATION

1. Press and hold the BAKE keypad for five (5) seconds. The current offset, if any, will be shown in the 3-digit display. CAL is shown in the 4-digit display (3 digits on right).
2. Pressing the TEMP keypad ▲ up arrow adjusts the temperature in 10°F increments in the following sequence: 0°, 10°, 20°, 30°, -30°, -20°, -10°, 0°, and so on.
3. Press the START/ENTER keypad to activate the desired temperature adjustment. If the START/ENTER keypad is not pressed within 5 minutes, the adjustment is ignored.

NOTE: The BAKE temperature adjustment cannot result in operating temperatures higher than 525°F, or lower than 170°F, as measured at

oven cavity center. Once the BAKE temperature has been adjusted, BROIL temperatures are automatically offset to the same degree.

The CLEAN temperature is also offset automatically when the BAKE temperature is adjusted. If the BAKE temperature has been raised, the CLEAN temperature is offset by +5°F. If the BAKE temperature has been lowered, the CLEAN temperature is offset to -5°F.

WIRING DIAGRAM & STRIP CIRCUITS

WIRING DIAGRAM

HARNESS JUMPER	OVEN CONFIGURATION		
	FREE STANDING	HIDDEN BAKE	COLOR
NO JUMPER	YES	YES	NO
P3-3 TO P3-4	YES	NO	WHITE
P3-3 TO P3-5	NO	YES	BLACK
P3-3 TO P3-7	NO	NO	RED

OVEN RELAY MODES	BAKE	BROIL	OVEN LIGHT	DOOR LOCK SWITCH	TOP LIGHT
	OFF	○	○	X	○
BAKE	●	○	X	○	X
BROIL	○	●	X	○	X
CLEAN FIRST 30 MIN.	○	○	○	●	X
CLEAN AFTER	●	○	○	○	X

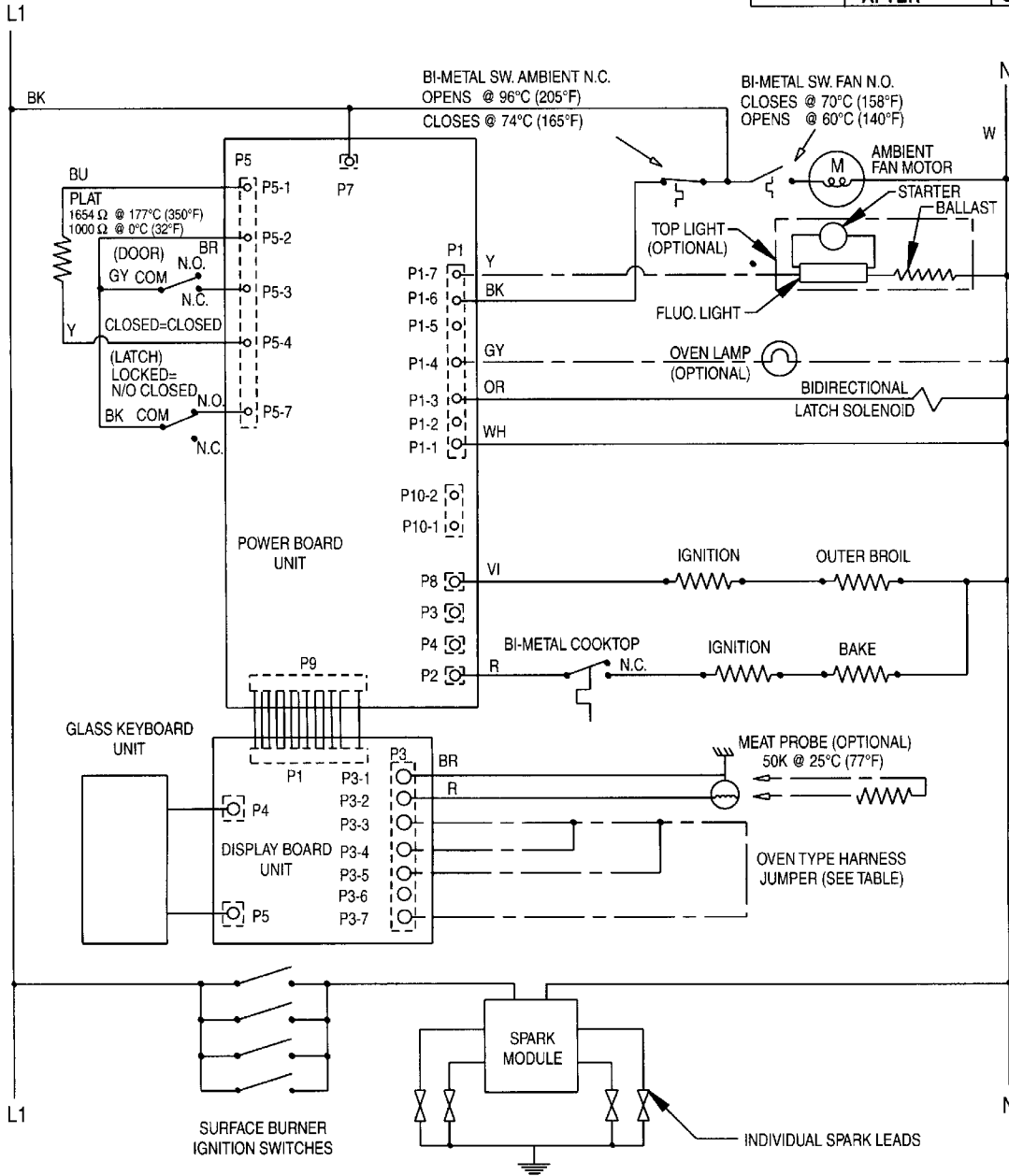

LEGEND

- = OFF
- = ON (CYCLE)
- X = CAN BE OFF OR ON (USER SETTING)

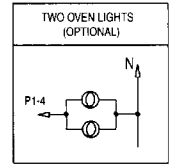

STRIP CIRCUITS

CLEAN (FIRST 30 MINUTES)

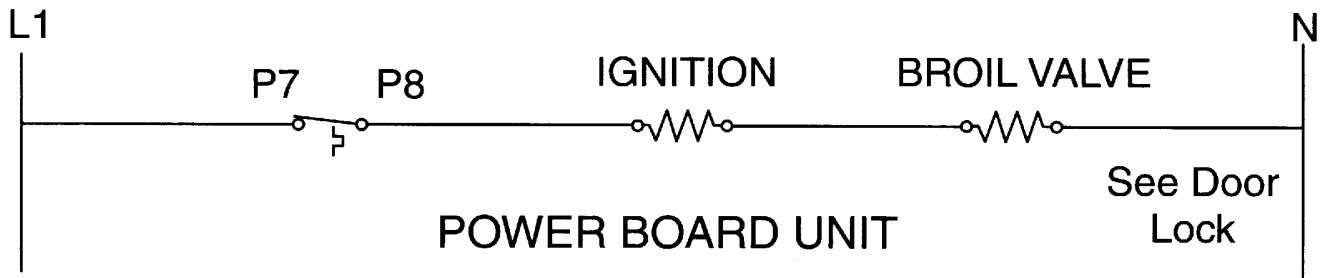

CLEAN (REST OF CYCLE)

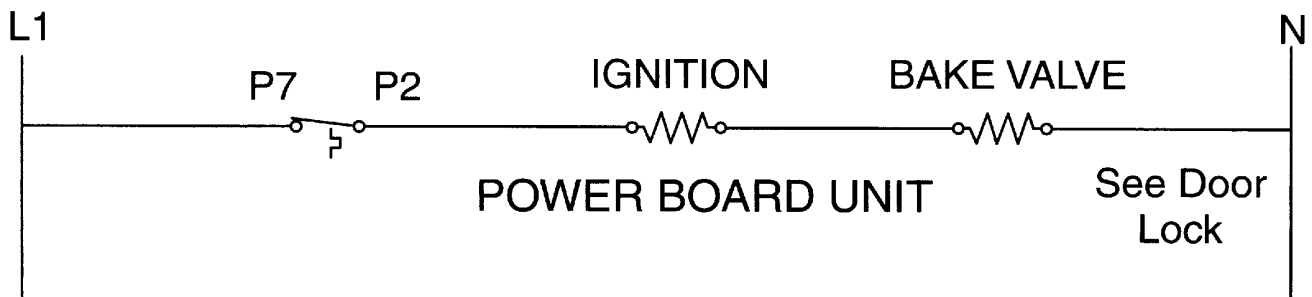

CONVECTION ROAST, CONVECTION BAKE, RAISING BREAD (DEHYDRATE)

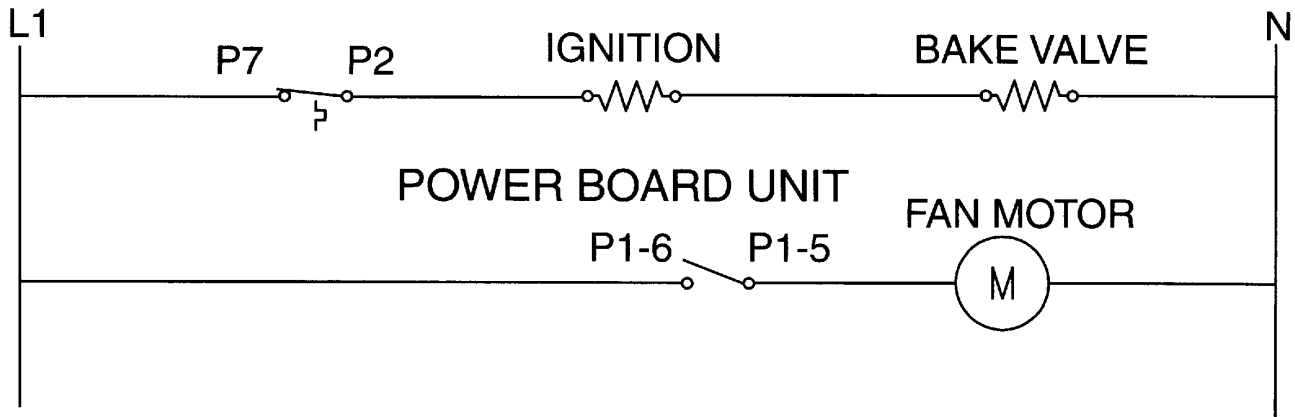

CONVECTION BROIL

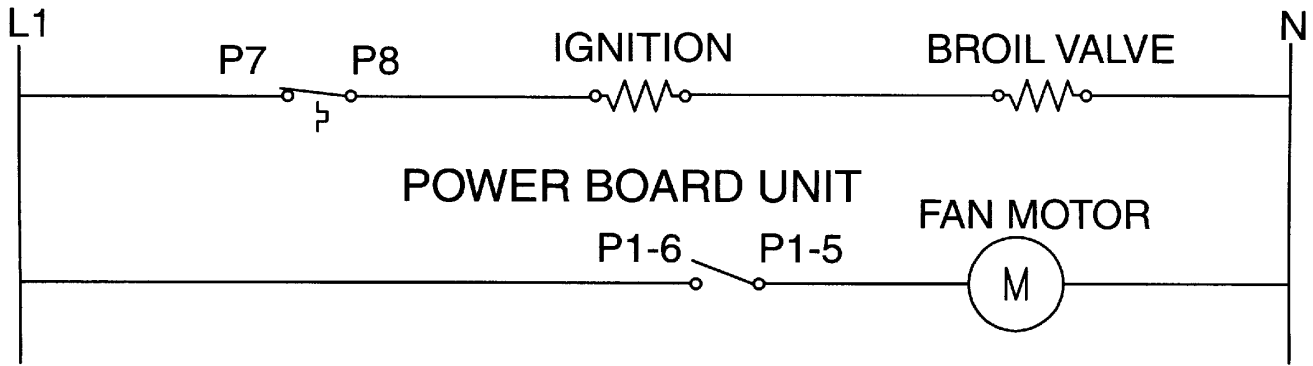

DOOR LOCK

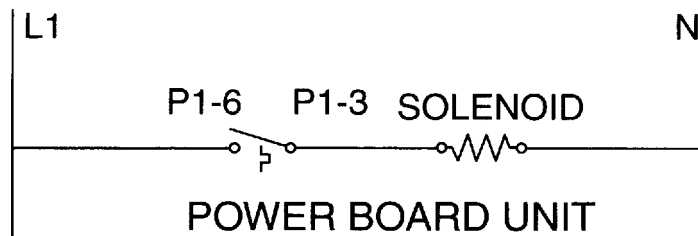

OVEN LIGHT

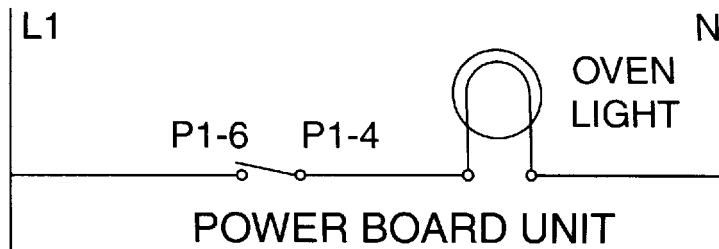

BAKE

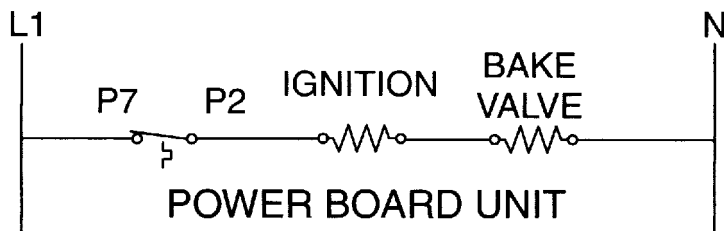

BROIL

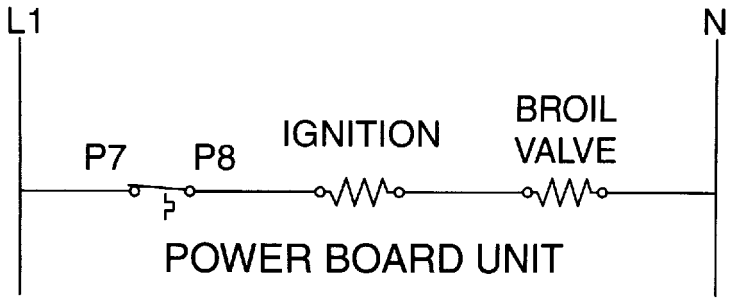

PRODUCT SPECIFICATIONS AND WARRANTY INFORMATION SOURCES

IN THE UNITED STATES:

FOR PRODUCT SPECIFICATIONS AND WARRANTY INFORMATION CALL:

FOR WHIRLPOOL PRODUCTS: 1-800-253-1301

FOR KITCHENAID PRODUCTS: 1-800-422-1230

FOR ROPER PRODUCTS: 1-800-447-6737

FOR TECHNICAL ASSISTANCE WHILE AT THE CUSTOMER'S HOME CALL:

THE TECHNICAL ASSISTANCE LINE: 1-800-253-2870

**HAVE YOUR STORE NUMBER READY TO IDENTIFY YOU AS AN
AUTHORIZED SERVICER**

FOR LITERATURE ORDERS:

PHONE: 1-800-851-4605

IN CANADA:

FOR PRODUCT SPECIFICATIONS AND WARRANTY INFORMATION CALL:

1-800-461-5681

FOR TECHNICAL ASSISTANCE WHILE AT THE CUSTOMER'S HOME CALL:

THE TECHNICAL ASSISTANCE LINE: 1-800-488-4791

**HAVE YOUR STORE NUMBER READY TO IDENTIFY YOU AS AN
AUTHORIZED SERVICER**

KitchenAid®
FOR THE WAY IT'S MADE.®

