

KitchenAid

TECHNICAL EDUCATION

FRENCH DOOR BOTTOM-MOUNT REFRIGERATOR



Models KBFA20ER & KBFA25ER

FORWARD

This KitchenAid Job Aid, “French Door Bottom-Mount Refrigerator” (Part No. 4317387), provides the technician with information on the installation, operation, and service of the French Door Bottom-Mount Refrigerator. For specific information on the model being serviced, refer to the “Use and Care Guide,” or “Tech Sheet” provided with the French Door Bottom-Mount Refrigerator.

The Wiring Diagrams used in this Job Aid are wtypical and should be used for training purposes only. Always use the Wiring Diagram supplied with the product when servicing the unit.

GOALS AND OBJECTIVES

The goal of this Job Aid is to provide information that will enable the service technician to properly diagnose malfunctions and repair the French Door Bottom-Mount Refrigerator.

The objectives of this Job Aid are to:

- Understand and follow proper safety precautions.
- Successfully troubleshoot and diagnose malfunctions.
- Successfully perform necessary repairs.
- Successfully return the refrigerator to its proper operational status.

WHIRLPOOL CORPORATION assumes no responsibility for any repairs made on our products by anyone other than Authorized Service Technicians.

TABLE OF CONTENTS

Page

GENERAL	1-1
Safety First	1-1
KitchenAid Model & Serial Number Designations	1-2
Model & Serial Number Label & Tech Sheet Locations	1-3
Specifications	1-4
KitchenAid Refrigerator Warranty	1-5
INSTALLATION INFORMATION	2-1
Installation Instructions	2-1
PRODUCT OPERATION	3-1
Theory Of Operation	3-1
Product Operation	3-4
COMPONENT ACCESS	4-1
Component Locations	4-1
Removing The Refrigerator Thermistor, User Interface Board, Door Switch, & Light Socket	4-2
Removing The Motorized Air Door	4-4
Removing The Water Dispenser Switch Assembly	4-5
Removing The Water Reservoir	4-6
Removing The Water Filter Connector	4-7
Removing The Flipper Mullion	4-9
Removing The Freezer Door Switch & Light Socket	4-10
Removing The Freezer Thermistor	4-12
Removing The Ice Maker And Water Fill Tube	4-13
Removing The Evaporator Fan Motor, Defrost Bimetal, Defrost Heater, & Evaporator	4-14
Removing The Dual Water Valve	4-17
Removing The Main Electronic Control Board	4-19
Removing The Condenser Fan Motor	4-20
Removing The Compressor	4-21
Removing The Power Supply Cord	4-22
Removing The Front and Rear Rollers	4-23
Removing The Condensate Drain Pan & Condenser	4-25
COMPONENT TESTING	5-1
Refrigerator & Freezer Door Switches	5-1
Water Dispenser Switch	5-2
Flipper Mullion	5-2
Defrost Heater	5-3
Dual Water Valve	5-3
Compressor	5-4
DIAGNOSTICS & TROUBLESHOOTING	6-1
Diagnostic Tests	6-1
Troubleshooting	6-6
WIRING DIAGRAMS	7-1

— NOTES —

GENERAL SAFETY FIRST

Your safety and the safety of others is very important.

We have provided many important safety messages in this Job Aid and on the appliance. Always read and obey all safety messages.



This is the safety alert symbol.

This symbol alerts you to hazards that can kill or hurt you and others.

All safety messages will follow the safety alert symbol and either the word “DANGER” or “WARNING.” These words mean:

! WARNING

You can be killed or seriously injured if you don't immediately follow instructions.

! DANGER

You can be killed or seriously injured if you don't follow instructions.

All safety messages will tell you what the potential hazard is, tell you how to reduce the chance of injury, and tell you what can happen if the instructions are not followed.

KITCHENAID MODEL & SERIAL NUMBER DESIGNATIONS

MODEL NUMBER

MODEL NUMBER	K	BF	A	25	E	R	WH	00
PRODUCT GROUP K = KITCHENAID								
PRODUCT IDENTIFICATION BF = BTM FREEZER, FRENCH DOOR								
MERCHANDISING SCHEME/SERIES A = ARCHITECT								
CAPACITY 20 = 20 CU. FT. 25 = 25 CU. FT.								
MODEL FEATURES E = INTERIOR WATER DISPENSER								
YEAR OF INTRODUCTION R = 2005								
COLOR CODE BL = BLACK WH = WHITE SS = STAINLESS STEEL								
ENGINEERING CHANGE DIGITS (00, 01, 02, ETC.)								

SERIAL NUMBER

SERIAL NUMBER	EC	S	21	1	2	3	4	5
MANUFACTURING RESPONSIBILITY EC = EVANSVILLE, IN								
YEAR OF PRODUCTION S = 2005								
WEEK OF PRODUCTION 21ST WEEK								
PRODUCT SEQUENCE NUMBER								

MODEL & SERIAL NUMBER LABEL & TECH SHEET LOCATIONS

The Model & Serial Number label location is shown below.

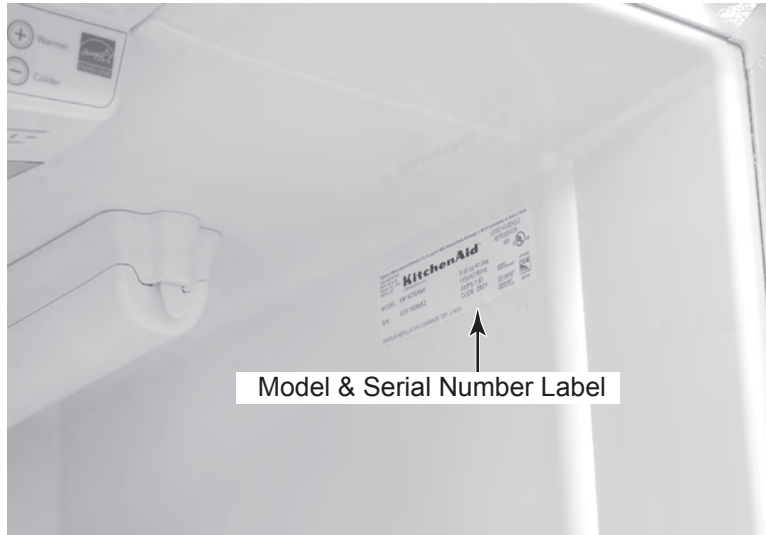

The Tech Sheet location is shown below.



SPECIFICATIONS

Component	Specifications all parts 115VAC/60HZ unless noted	
Compressor run capacitor	Volt.....	220 VAC
	Capacitance	15 μ fd \pm 10%
Compressor	BTUH	905 BTUH
	Watt	60 Hz / 153 watts
	Current Lock rotor	19.0 amps \pm 15%
	Current Full load	1.26 amps \pm 15%
	Resistance Run windings.....	3.33 ohms \pm 15%
	Resistance Start windings.....	4.28 ohms \pm 15%
Electric damper control	Maximum closing time	36 seconds
	Temperature Rating	20°F- 110°F
	RPM	1
Thermistor	Temperature	Resistance
	77°F.....	10,000 ohms \pm 1.8%
	36°F	29,500 ohms \pm 1.0%
	0°F.....	86,300 ohms \pm 1.8%
Condenser motor	Rotation (facing end opposite shaft)	Clockwise
	RPM	1120 RPM
	Watt.....	3.4 watts \pm 15%@115VAC
	Current	0.085 amps \pm 15%@115VAC
Evaporator fan motor	Rotation (facing end opposite shaft)	Clockwise
	RPM.....	2940 RPM
	Watt.....	4.6 \pm 15% watts@115 VAC
	Note: Fan blade must be fully seated on shaft to achieve proper airflow.	
Overload/Relay	Ult. trip amps @ 158°F (70°C)	2.67 amps \pm 15%
	Close temperature	142°F \pm 9°
	Open temperature	284°F \pm 9°
	Short time trip (seconds).....	10 seconds \pm 5
	Short time trip (amps @77°F (25°C) ..	11 amps \pm 2amps
Thermostat (Defrost)	Volt	120/240 VAC
	Watt	495 watts
	Current	5.8/2.9 amps
	Resistance across terminals:	
	Above 42°F \pm 5°	Open
	Below 12°F \pm 7°	Closed
Evaporator heater	Volt.....	115 VAC
	Wattage	470 \pm 5% watts @ 115VAC
	Resistance	29 \pm 5% ohms
Control board	Volt.....	120VAC, 60 HZ
	See Control board troubleshooting section	
Water Valve	Watts.....	Brown side 35w, Yellow side 20w
Light switch / Interlock	Type.....	SPDT NO/NC
	Volt.....	125/250 VAC
	Current.....	8/4 amps

KITCHENAID® REFRIGERATOR WARRANTY

TWO-YEAR FULL WARRANTY

For two years from the date of purchase, when this refrigerator (excluding the water filter cartridges) is operated and maintained according to instructions attached to or furnished with the product, KitchenAid will pay for factory specified replacement parts and repair labor costs to correct defects in materials or workmanship. Service must be provided by a KitchenAid designated service company.

Water filter cartridge: 30 day limited warranty on water filter. For 30 days from the date of purchase, when this filter is operated and maintained according to instructions attached to or furnished with the product, KitchenAid will pay for replacement parts to correct defects in materials and workmanship.

THIRD THROUGH SIXTH YEAR FULL WARRANTY ON SEALED REFRIGERATION SYSTEM PARTS AS LISTED

In the third through sixth years from the date of purchase, when this refrigerator is operated and maintained according to instructions attached to or furnished with the product, KitchenAid will pay for factory specified replacement parts and repair labor costs to correct defects in materials or workmanship in the sealed refrigeration system. These parts are: compressor, evaporator, condenser, dryer, and connecting tubing. Service must be performed by a KitchenAid designated service company.

SEVENTH THROUGH TWELFTH YEAR LIMITED WARRANTY ON SEALED REFRIGERATION SYSTEM

In the seventh through twelfth years from date of purchase, when this refrigerator is operated and maintained according to instructions attached to or furnished with the product, KitchenAid will pay for factory specified replacement parts to correct defects in materials or workmanship in the sealed refrigeration system. These parts are: compressor, evaporator, condenser, dryer, and connecting tubing.

LIFETIME LIMITED WARRANTY ON DOOR BINS

For the life of the product, when this refrigerator is operated and maintained according to instructions attached to or furnished with the product, KitchenAid will replace all Door Bins due to defective materials or workmanship.

KitchenAid will not pay for:

1. Service calls to correct the installation of your refrigerator, to instruct you how to use your refrigerator, to replace house fuses or correct house wiring or plumbing, to replace light bulbs, or to replace water filters other than as noted above.
2. Repairs when your refrigerator is used in other than normal, single-family household use.
3. Pickup and delivery. Your refrigerator is designed to be repaired in the home.
4. Damage resulting from accident, alteration, misuse, abuse, fire, flood, improper installation, acts of God, or use of products not approved by KitchenAid, or KitchenAid Canada.
5. Any food or medicine loss due to product failure.
6. Repairs to parts or systems resulting from unauthorized modifications made to the appliance.
7. Removal and replacement of trim or decorative panels that interfere with servicing the product.
8. Labor or parts installed by any non-designated service company during the full warranty period, unless approved by KitchenAid before service is performed.
9. In Canada, travel or transportation expenses for customers who reside in remote areas.
10. Any labor costs during the limited warranty periods.

KITCHENAID AND KITCHENAID CANADA SHALL NOT BE LIABLE FOR INCIDENTAL OR CONSEQUENTIAL DAMAGES.

Some states or provinces do not allow the exclusion or limitation of incidental or consequential damages, so this exclusion or limitation may not apply to you. This warranty gives you specific legal rights, and you may also have other rights which vary from state-to-state, or province-to-province.

Outside the 50 United States and Canada, a different warranty may apply. Contact your authorized KitchenAid dealer to determine if another warranty applies.

If you need service, first see the "Troubleshooting" section of the Use and Care Guide. After checking "Troubleshooting," additional help can be found by checking the "Assistance or Service" section, or by calling the KitchenAid Customer Interaction Center, **1-800-422-1230** (toll-free), from anywhere in the U.S.A. In Canada, contact your designated KitchenAid Canada service company, or call **1-800-807-6777**.

— NOTES —

INSTALLATION INFORMATION

INSTALLATION INSTRUCTIONS

LOCATION REQUIREMENTS

! WARNING

Excessive Weight Hazard

Use two or more people to move and install refrigerator.

Failure to do so can result in back or other injury.

! WARNING



Explosion Hazard

Keep flammable materials and vapors, such as gasoline, away from refrigerator.

Failure to do so can result in death, explosion, or fire.

- The refrigerator is designed for indoor, household use only.
- To ensure proper ventilation for the refrigerator, allow for a 1/2" (1.25 cm) space at the top and behind the refrigerator.
- If the refrigerator has an ice maker, allow extra space at the back for the water line connections.
- When installing the refrigerator next to a fixed wall, leave 2-1/8" (5.4 cm) minimum on each side (depending on the model) to allow for the door to swing open.

NOTE: It is recommended that you do not install the refrigerator near an oven, radiator, or other heat source. Do not install the refrigerator in a location where the temperature will fall below 55°F (13°C).

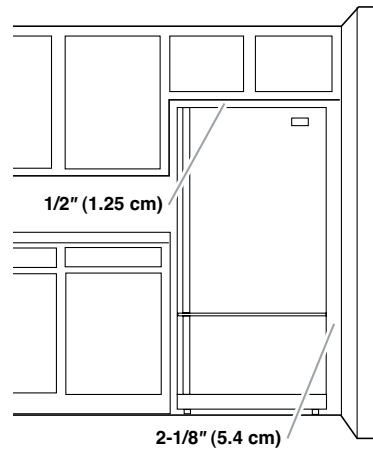

ELECTRICAL REQUIREMENTS

! WARNING



Electrical Shock Hazard

Plug into a grounded 3 prong outlet.

Do not remove ground prong.

Do not use an adapter.

Do not use an extension cord.

Failure to follow these instructions can result in death, fire, or electrical shock.

Before you move your refrigerator into its final location, it is important to make sure you have the proper electrical connection.

Recommended Grounding Method

A 115 Volt, 60 Hz., AC only 15- or 20-amp fused, grounded electrical supply is required. It is recommended that a separate circuit serving only your refrigerator be provided. Use an outlet that cannot be turned off by a switch. Do not use an extension cord.

NOTE: Before performing any type of installation, cleaning, or removing a light bulb, turn the control (Thermostat, Refrigerator or Freezer Control depending on the model) OFF and then disconnect the refrigerator from the electrical source. When you are finished, reconnect the refrigerator to the electrical source and reset the control (Thermostat, Refrigerator or Freezer Control depending on the model) to the desired setting.

WATER SUPPLY REQUIREMENTS

Read all directions before you begin.

IMPORTANT:

- If you turn the refrigerator on before the water line is connected, turn the ice maker OFF.
- All installations must meet local plumbing code requirements.
- Use copper tubing and check for leaks. Install copper tubing only in areas where the household temperatures will remain above freezing.

TOOLS NEEDED: Gather the required tools and parts before starting installation. Read and follow the instructions provided with any tools listed below:

- Flat-blade screwdriver
- 7/16" & 1/2" open-end wrenches, or two adjustable wrenches
- 1/4" nut driver
- Hand drill or electric drill (properly grounded)
- 1/4" drill bit

NOTE: Your refrigerator dealer has a kit available with a 1/4" (6.35 mm) saddle-type shut-off valve, a union, and copper tubing. Before purchasing, make sure a saddle-type valve complies with local plumbing codes. Do not use a piercing-type or 3/16" (4.76 mm) saddle valve which reduces water flow and clogs more easily.

Water Pressure

A cold water supply with water pressure of between 35 and 100 psi (241- 689 kPa) is required to operate the water dispenser and ice maker. If you have questions about your water pressure, call a licensed, qualified plumber.

Reverse Osmosis Water Supply

IMPORTANT: The pressure of the water supply coming out of a reverse osmosis system going to the water inlet valve of the refrigerator needs to be between 35 and 100 psi (241-689 kPa).

If a reverse osmosis water filtration system is connected to a cold water supply, the water pressure to the reverse osmosis system needs to be a minimum of 40 to 60 psi (276 - 414 kPa).

If the water pressure to the reverse osmosis system is less than 40 to 60 psi (276 - 414 kPa):

- Check to see whether the sediment filter in the reverse osmosis system is blocked. Replace the filter if necessary.
- Allow the storage tank on the reverse osmosis system to refill after heavy usage.
- If the refrigerator has a water filter, it may further reduce the water pressure when used in conjunction with a reverse osmosis system. Remove the water filter.

If you have questions about the water pressure, call a licensed, qualified plumber.

REFRIGERATOR DOORS

Remove and Replace Handles

1. Using a 3/32" Allen wrench, loosen the two set screws located on the side of each handle (see graphics 1 and 2 on page 2-4).
2. Pull the handle straight out from the door. Make sure you keep the screws for reattaching the handles.
3. To replace the handles, reverse the directions.

Remove Doors and Hinges

⚠ WARNING

Electrical Shock Hazard Disconnect power before removing doors. Failure to do so can result in death or electrical shock.

IMPORTANT: Remove food and any adjustable door or utility bins from the doors.

TOOLS NEEDED:

- 5/16", 3/8", and 1/4" hex-head socket wrench
- #2 Phillips screwdriver
- Flat-blade screwdriver

1. Unplug refrigerator or disconnect power.
2. Keep the refrigerator doors closed until you are ready to lift them from the cabinet.

NOTE: Provide additional support for the refrigerator door while the hinges are being removed. Do not depend on the door gasket magnets to hold the door in place while you are working.

3. Starting with the right-hand side door, remove the parts for the top hinge, as shown in Top Hinge graphic on page 2-4. Lift the refrigerator door from the bottom hinge pin.
4. Remove the shim from the bottom hinge pin and keep it for later use (see Bottom Hinge graphic on page 2-4).
5. Before removing the left-hand side door, disconnect the wire harness located on top of the top hinge by wedging a flat-blade screwdriver or your fingernail between the two sections (see Wire Harness graphic on page 2-4).

NOTE: The green, ground wire remains attached to the hinge.

6. Remove the parts for the top hinge, as shown in Top Hinge graphic, and lift the left-hand side door from the bottom hinge pin.
7. Remove the shim from the bottom hinge pin and keep it for later use (see Bottom Hinge graphic).

Replace Doors and Hinges

1. Assemble the parts for the top hinge, as shown in Top Hinge graphic. Do not tighten the screws completely.

2. Replace the parts for the bottom hinge as shown in Bottom Hinge graphic. Tighten screws. Replace the refrigerator door.

NOTE: Provide additional support for the refrigerator door while the hinges are being moved. Do not depend on the door gasket magnets to hold the door in place while you are working.

3. Align the door so that the bottom of the refrigerator door aligns evenly with the top of the freezer drawer, and then tighten all of the screws.
4. Reconnect the wire harness on top of the left-hand side refrigerator door.
5. Replace the top hinge covers.

DOOR REMOVAL AND REPLACEMENT

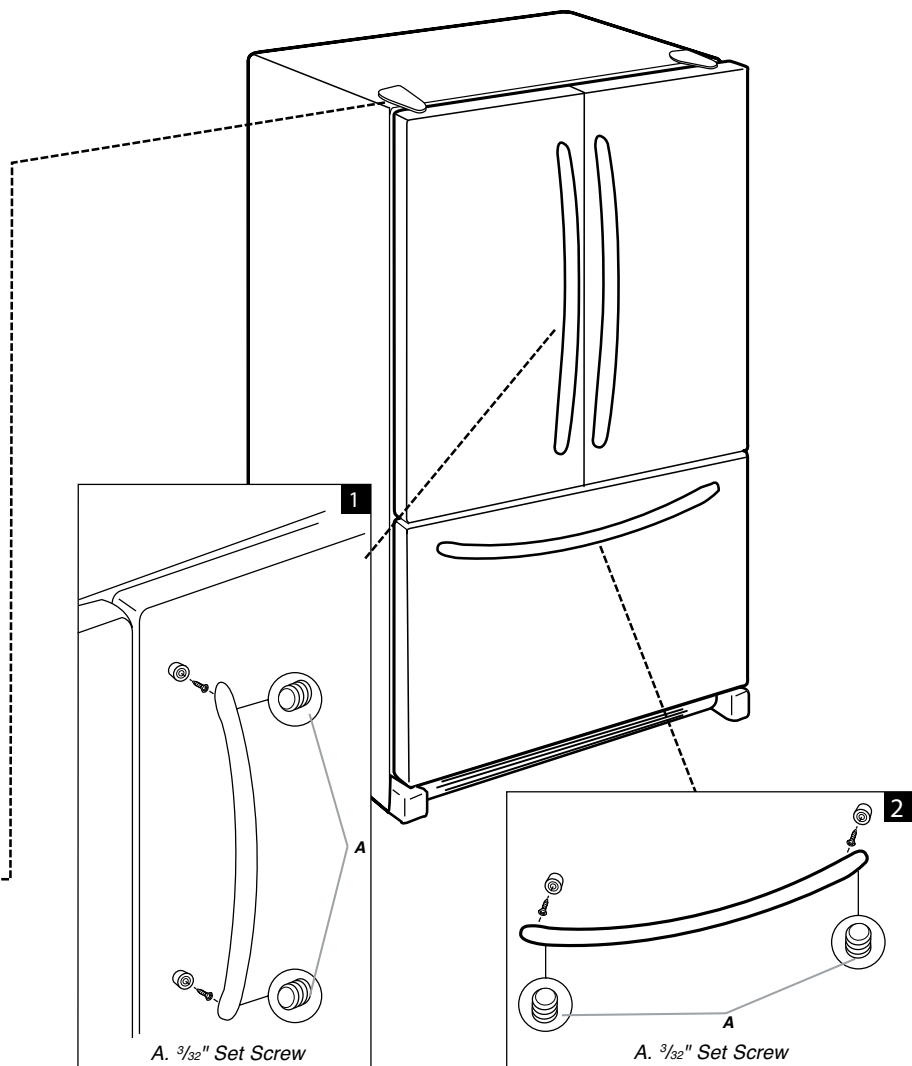
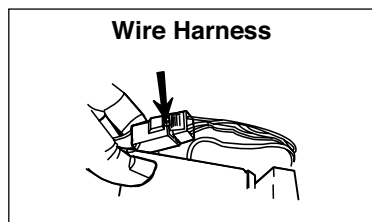
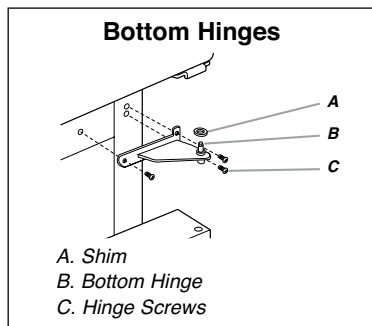
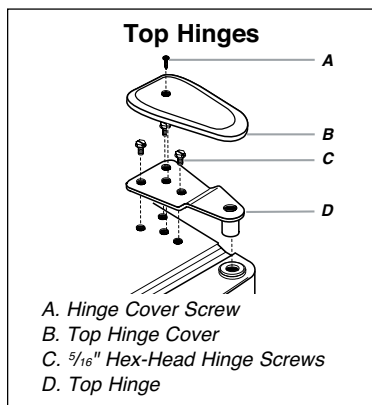

ADJUSTING THE DOORS

Depending on the model, the refrigerator may have two (Style 1) or four (Style 2) adjustable rollers located at the base of the refrigerator. If the refrigerator seems unsteady, or you want the door to close easier, adjust the refrigerator's tilt using the instructions below.

⚠ WARNING

Excessive Weight Hazard

Use two or more people to move and install refrigerator.

Failure to do so can result in back or other injury.

1. Move the refrigerator into its final location.
2. Remove the base grille. Grasp the grille firmly and pull it toward you.
3. Remove the bracket covers. Insert the eraser end of a pencil in the cover notch. Apply slight downward pressure to the notched side of the cover while swinging it off.

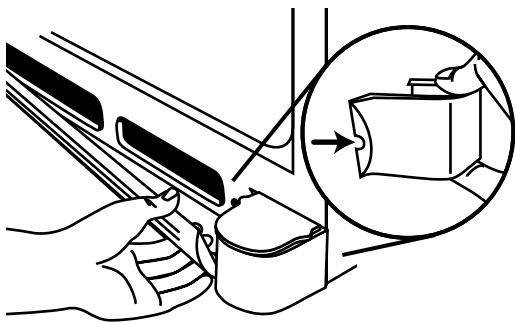

4. Using a screwdriver or 3/8" hex driver, turn the roller adjustment screw(s) on each side to raise or lower that side of the refrigerator.

NOTE: Have someone push against the top of the refrigerator to take some weight off the adjustment screws and rollers so the screws are easier to turn.

- To raise, turn the roller adjustment screw to the right.
- To lower, turn the roller adjustment screw to the left.

NOTE: It may take several turns of the roller adjustment screw to adjust the tilt of the refrigerator

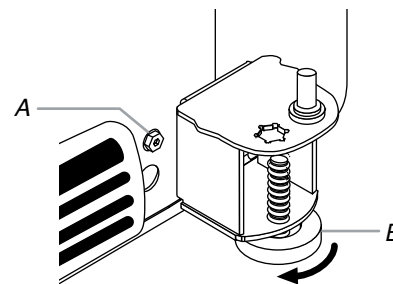

- A. Roller adjustment screw
- B. Stabilizing foot

Style 1 - Front leveling

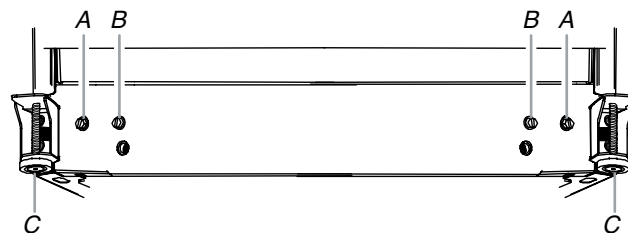

- A. Front adjustment screw
- B. Rear adjustment screw
- C. Stabilizing foot

Style 2 - Front and rear leveling

5. Open the door again to make sure that it closes as easily as you like. If not, tilt the refrigerator slightly more to the rear by turning both front adjustment screws to the right. It may take several more turns, and you should turn both adjustment screws the same amount.
6. Lower the stabilizing foot by turning it clockwise until it is firmly against floor.
7. Turn the front adjustment screws counterclockwise to allow the full weight of the refrigerator to rest on the stabilizing feet.
8. Replace the bracket covers. Place each bracket cover into the outer edge, swing the cover toward the cabinet and snap it into place.
9. Replace the base grille.

— NOTES —

PRODUCT OPERATION

THEORY OF OPERATION

TEMPERATURE MANAGEMENT

The KitchenAid French Door Bottom-Mount Refrigerator uses a thermistor in each cooling compartment to maintain proper temperatures. An electronic control, mounted in the unit compartment, monitors the thermistors in each compartment. As the freezer temperature warms, the control energizes the compressor and evaporator fan motors to cool the compartment.

When the refrigerator temperature rises and warms the refrigerator thermistor, the control energizes the mechanical air damper motor to move it to the open position. At the same time, the evaporator fan motor begins to run to bring cool air up from the freezer. As noted above, the compressor will run as needed based on the temperature in the freezer compartment, but the evaporator fan motor can run without the compressor when the refrigerator is calling for cooling.

REFRIGERATOR DAMPER OPERATION

When the refrigerator compartment warms and cooling is required, power is applied to the YL/RD wire on the damper switch. The damper motor runs until the damper switch changes to the normally open (N.O.) position, and the motor stops with the damper door fully open. Power remains on the YL/RD wire as long as cooling is required.

When the proper temperature is reached in the refrigerator compartment, the electronic control switches power to the BU/RD wire. The motor runs until the damper switch closes into the normally closed (N.C.) position, and the motor stops with the damper door fully closed.

Power will always be applied to either the BU/RD (temperature satisfied and the damper door is closed), or the YL/RD (calling for cooling and the damper door is open). The maximum opening or closing time is 36 seconds.

CABINET AIR FLOW

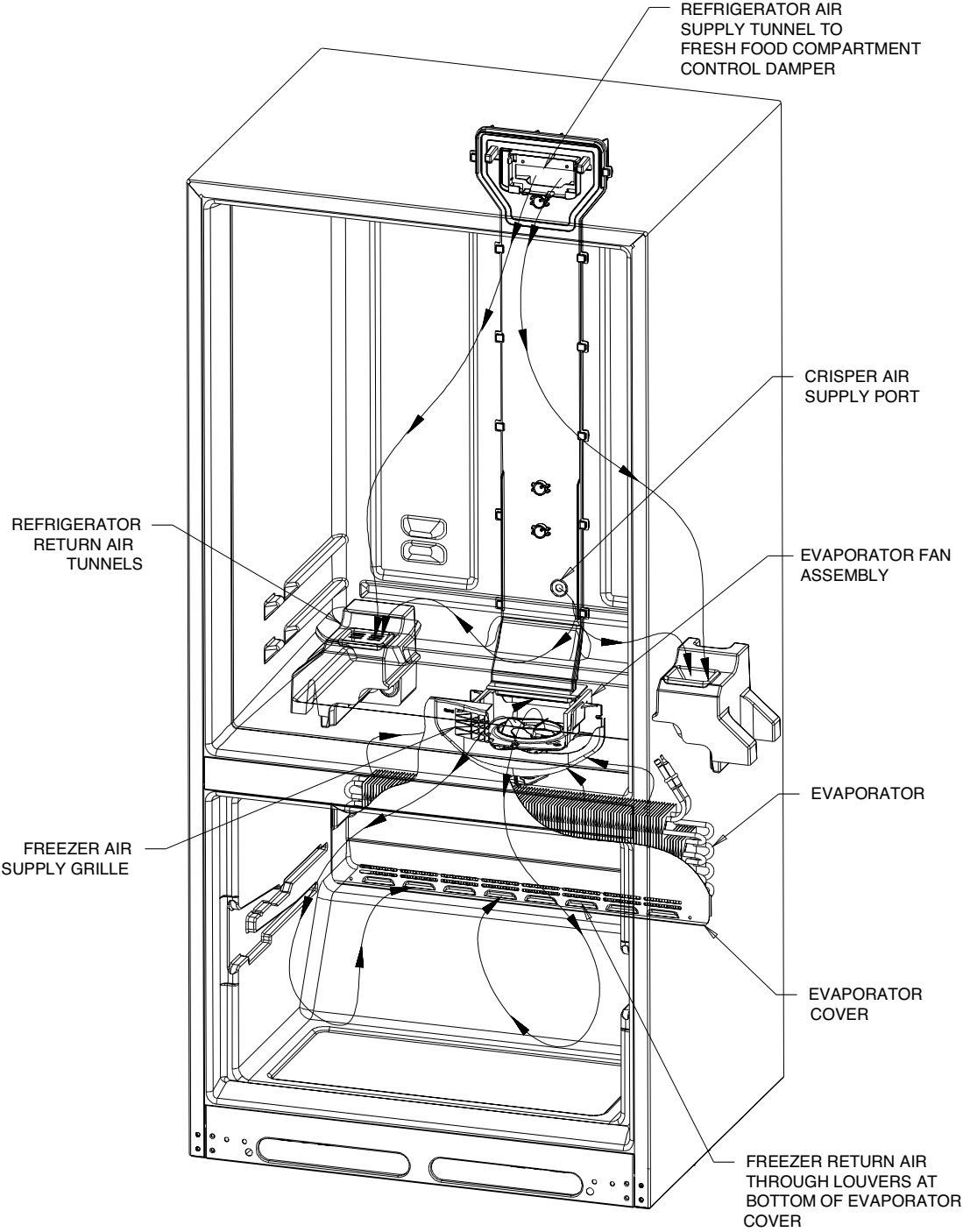

WATER DISPENSING FLOW

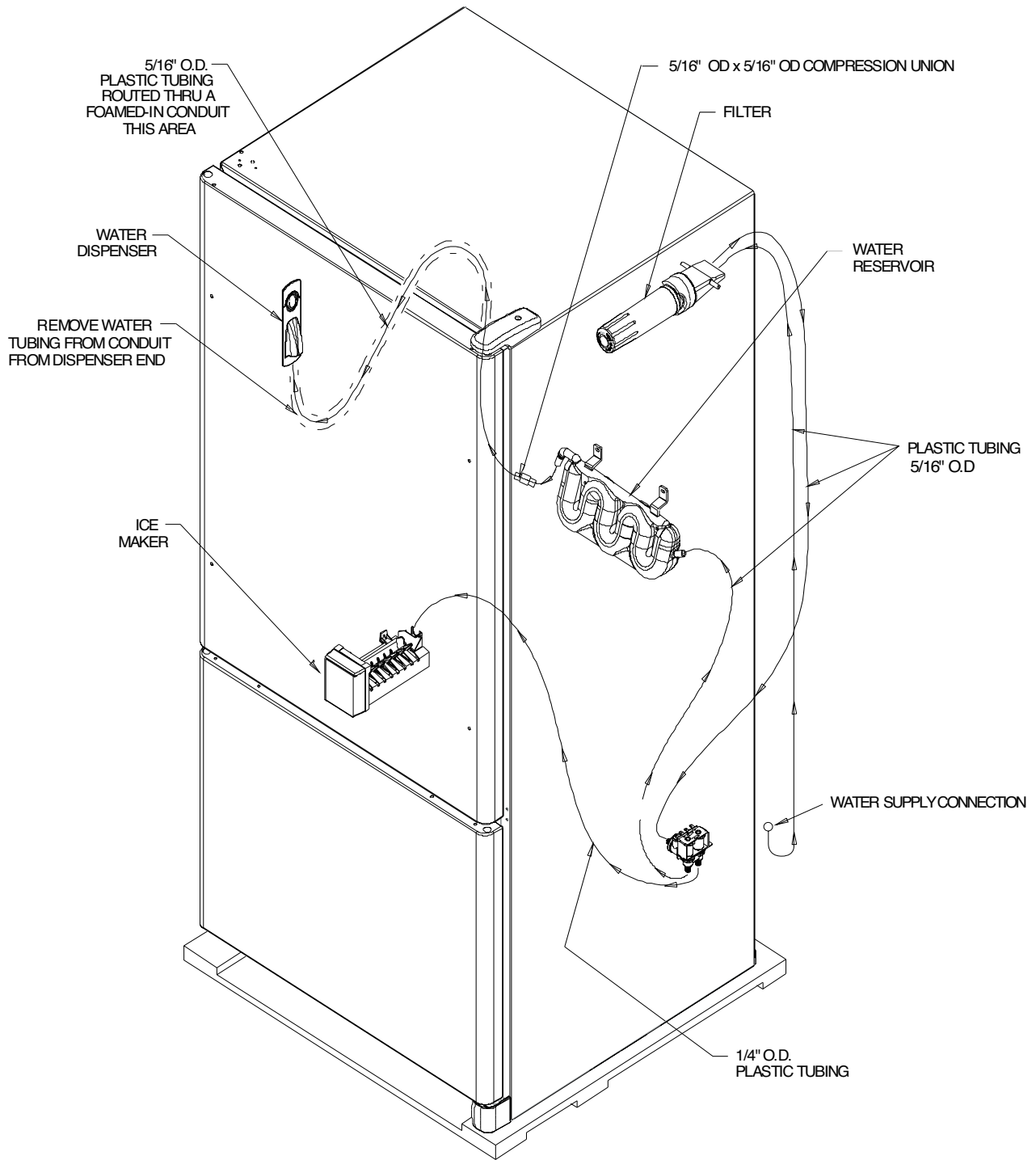

PRODUCT OPERATION

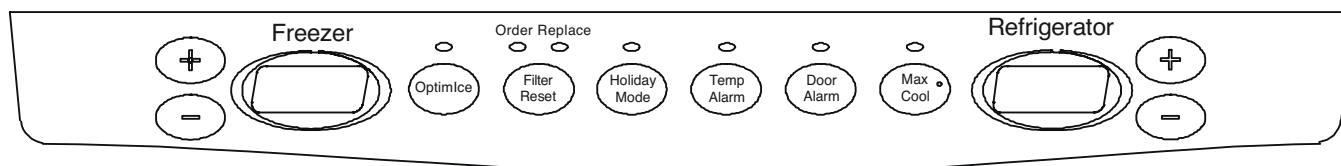

USER INTERFACE

USER INTERFACE FEATURES

MAX COOL

The max cool feature assists with periods of high refrigerator use, full grocery loads, or temporarily warm room temperatures.

- Press the Max Cool touchpad to set the freezer and refrigerator to the lowest temperature settings. Press the Max Cool touchpad again to return to the normal refrigerator setpoint.

NOTE: The Max Cool feature will automatically shut off in approximately 12 hours.

OPTIMICE® FEATURE

The OptimIce® feature assists with temporary periods of heavy ice use by increasing ice production.

- Press the OptimIce® feature touchpad to set the freezer to the lowest temperature setting. Press the OptimIce® feature touchpad again to return to the normal freezer setpoint.

NOTE: The OptimIce® feature will automatically shut off in approximately 24 hours.

HOLIDAY MODE

In Holiday Mode, the freezer will not automatically defrost as often to conserve energy.

- Press the Holiday Mode touchpad until the indicator light is lit to turn on this feature. Press the Holiday Mode touchpad again, or open the refrigerator door to turn off this feature.

NOTE: The refrigerator door may be opened within 1 hour of setting Holiday Mode without turning off the feature.

TEMP ALARM

The Temperature Alarm combines power outage and warm alarm features.

POWER OUTAGE

During a power outage, if the temperatures in the refrigerator and freezer compartments exceed normal operating temperatures, the highest temperature reached will be displayed.

- Press the Temp Alarm touchpad until the indicator light is lit, to turn on this feature. Press and hold Temp Alarm for 3 seconds until the indicator light goes off to turn off this feature.

WARM ALARM

An alarm will sound repeatedly if the freezer or refrigerator compartment temperatures exceed normal operating temperatures for an hour or more.

The temperature displays will alternately show the current temperatures and the highest temperatures the compartments reached when the power was out.

- Press the Temp Alarm touchpad once to stop the audible alarm and alternating temperature displays. The Temp Alarm light will continue to flash until the refrigerator temperature stabilizes.

DOOR ALARM

The Door Alarm feature sounds a chime every few seconds when the refrigerator door has been left open for 5 continuous minutes. The chime will sound until the door is closed or Door Alarm is turned off.

- Press the Door Alarm touchpad to turn this feature on or off. The indicator light will be lit when the Door Alarm feature is on.

USER PREFERENCES

The user interface allows you to set user preferences, if desired.

TEMPERATURE DISPLAY (F OR C)

This preference allows you to change the temperature display.

F - Temperature in degrees Fahrenheit

C - Temperature in degrees Celsius

ALARM (AL)

This preference allows you to turn off the sound of all alarms.

ON - You will hear the alarm sound.

OFF - You will not hear the alarm sound.

SABBATH MODE (SAB)

IMPORTANT: This preference does not disable interior lights.

ON - All control panel lights will be disabled.

OFF - All control panel lights will be enabled.

NOTE: Press any touchpad on the user interface to restore the user interface lights.

TO ACCESS THE USER PREFERENCES MENU:

1. Press and hold the Door Alarm touchpad for 3 seconds. The preference name will appear in the freezer display, and the preference status (F or C) or (ON or OFF) will appear in the refrigerator display.
2. Use the freezer (+) or (-) touchpads to scroll through the preference names. When the desired preference name is displayed, press the refrigerator (+) or (-) touchpads to change the preference status.
3. Set the preferences by pressing and holding the Door Alarm touchpad for 3 seconds, or by closing the refrigerator compartment door.

ICE PRODUCTION RATE

- **Normal Ice Production:** The ice maker should produce a complete batch of ice every 3 hours. If ice is not being made fast enough, adjust the freezer control to a lower (colder) number in steps. Wait 24 hours. If necessary, gradually adjust the freezer control to the lowest setting. Wait 24 hours between each adjustment.
- **OptimIce Production (Some Models):** The ice maker should produce approximately 16 to 20 batches of ice in a 24-hour period. If your refrigerator has the OptimIce production feature, press the OptimIce touchpad.

REMEMBER

- Allow 24 hours to produce the first batch of ice. Discard the first three batches of ice produced.
- The quality of your ice will be only as good as the quality of the water supplied to your ice maker. Avoid connecting the ice maker to a softened water supply. Water softener chemicals (such as salt) can damage parts of the ice maker and lead to poor quality ice. If a softened water supply cannot be avoided, make sure the water softener is operating properly and is well maintained.
- Do not store anything on top of the ice maker, or in the ice storage bin.

— NOTES —

COMPONENT ACCESS

This section instructs you on how to service each component inside the French Door Bottom-Mount Refrigerator. The components and their locations are shown below.

COMPONENT LOCATIONS

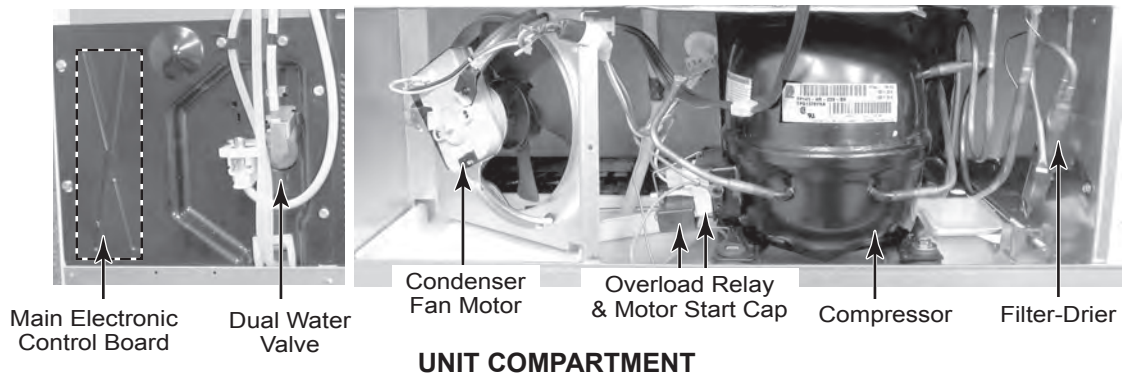
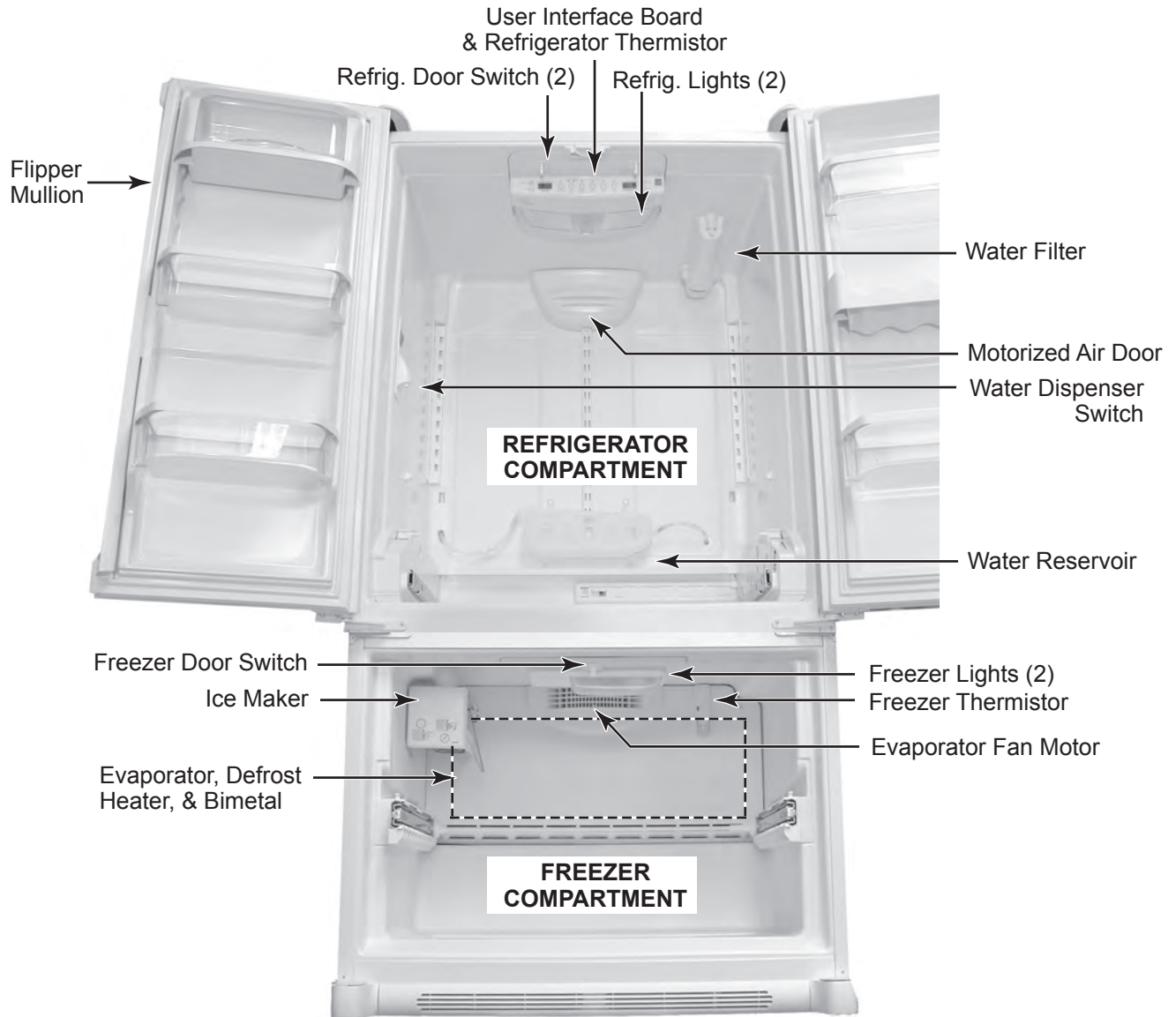

UNIT COMPARTMENT

REMOVING THE REFRIGERATOR THERMISTOR, USER INTERFACE BOARD, DOOR SWITCH, & LIGHT SOCKET

⚠ WARNING



Electrical Shock Hazard

Disconnect power before servicing.
Replace all parts and panels before operating.

Failure to do so can result in death or electrical shock.

1. Unplug refrigerator or disconnect power.
2. Open the refrigerator compartment doors and remove any items that are below the user interface.
3. Hook a thumb in the indent of the light shield, pull back on the shield, and remove it from the user interface housing.

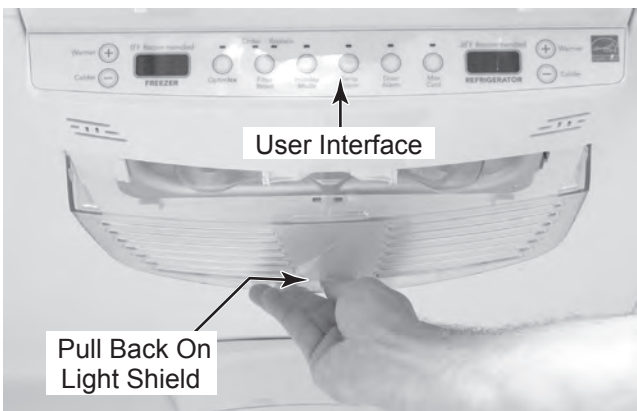

4. Place the tip of a flat-bladed screwdriver into each of the slots in the bottom of the user interface, (see the photos at the top right), and twist the screwdriver to release the locking tabs from the interface. Lower the interface assembly.

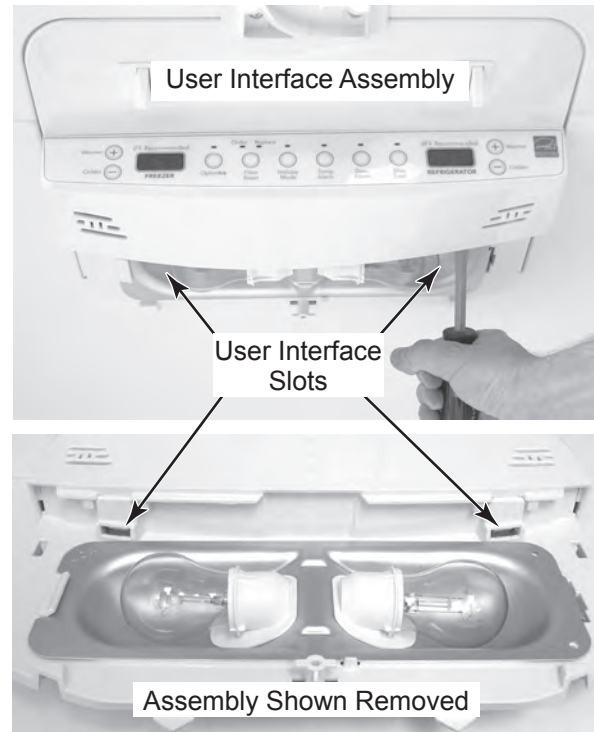

5. **To remove the refrigerator thermistor:**
 - a) Pull the thermistor out of the user interface housing clips.
 - b) Cut the wires coming from the thermistor near the body.
 - c) Splice the ends of the wires from the replacement thermistor, to the ends of the wires you cut from the old thermistor in the previous step. **NOTE:** Trim the wire lengths, as necessary, so that they fit neatly into place when the user interface is reinstalled.

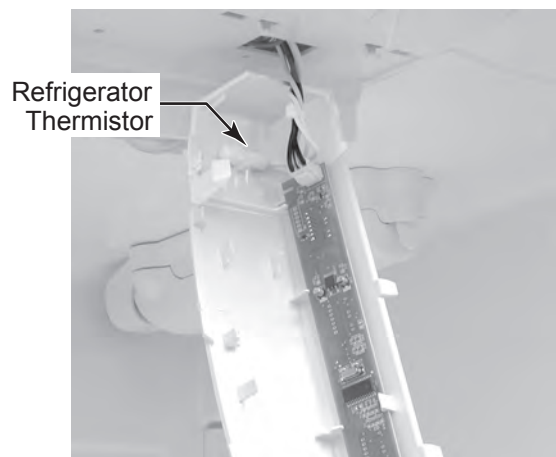

6. **To remove the user interface board:**

- a) Disconnect the 3-wire board connector at J1.
- b) Press and release the locking arm, and disconnect the ribbon cable at board connector J2.
- c) Press and release the locking tab from the user interface board, and remove the board from the housing.

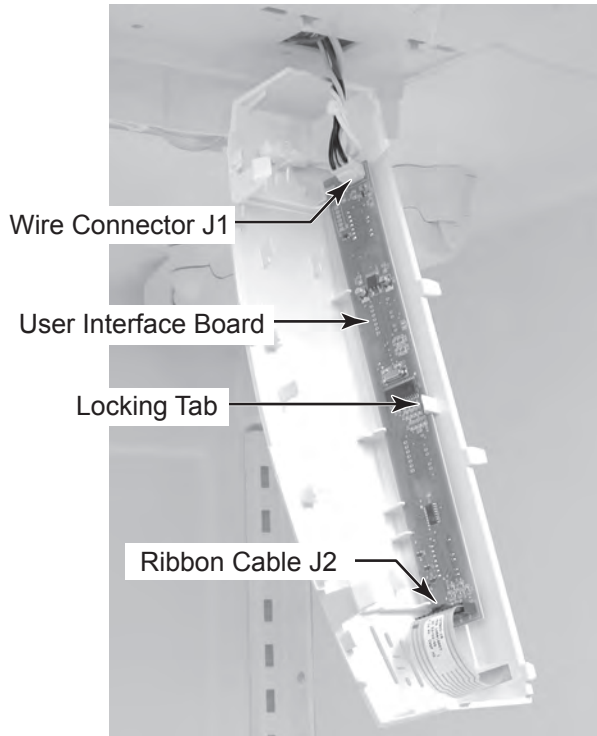

7. **To remove the refrigerator door switch:**

- a) Slide the end of a putty knife under the flange of the door switch, press it firmly against the locking tab of the switch, and pry the switch out of the liner.

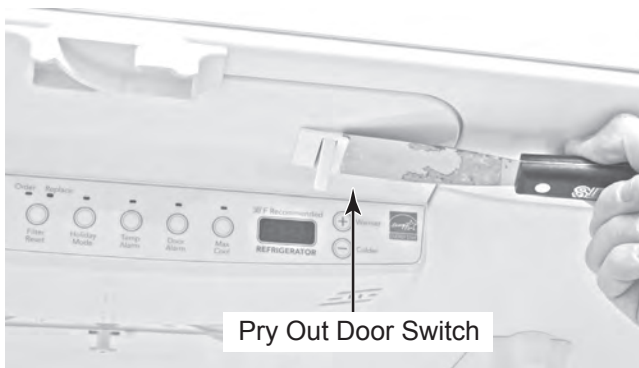

- b) Disconnect the wires from the refrigerator door switch terminals and remove the switch.

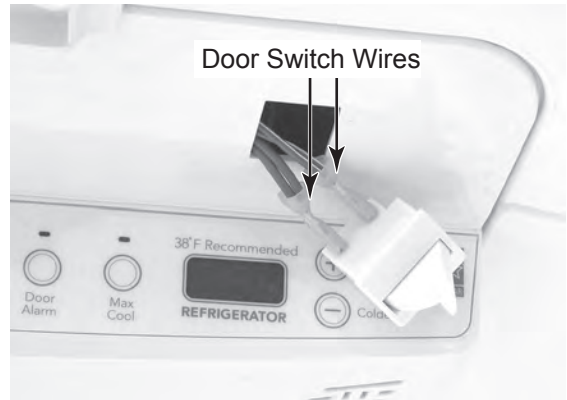

8. **To remove a refrigerator light socket:**

- a) Place the tip of a flat-bladed screwdriver into the right slot of the light reflector to release the locking tab, and lower the reflector assembly.



- b) Disconnect the wires from the light socket terminals.
- c) Unsnap the refrigerator light socket tab from the reflector and remove the socket.

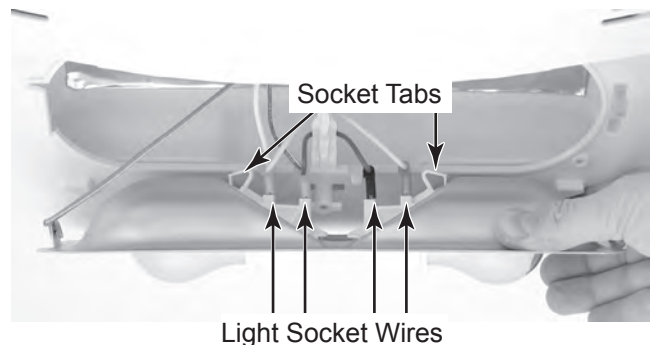

REMOVING THE MOTORIZED AIR DOOR

⚠ WARNING



Electrical Shock Hazard

Disconnect power before servicing.

Replace all parts and panels before operating.

Failure to do so can result in death or electrical shock.

1. Unplug refrigerator or disconnect power.
2. Open the refrigerator compartment doors and remove any items that are below the user interface.

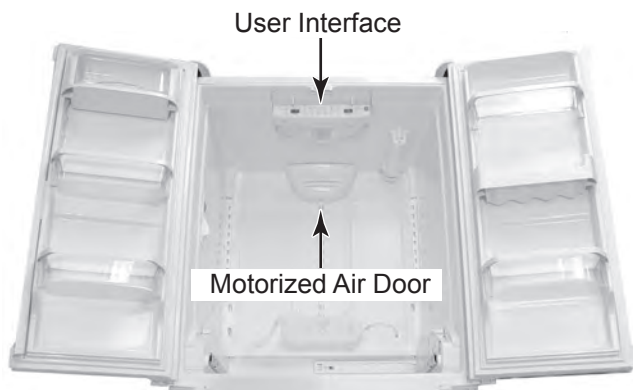

3. Place the tip of a flat-bladed screwdriver into the slot of the motorized air door cover, pry out to release the locking tabs, and remove the cover.



4. Remove the two screws from the motorized air door housing, and remove the housing from the liner.



5. Push out on the two tabs to release the motorized air door, and remove the air door from the liner.

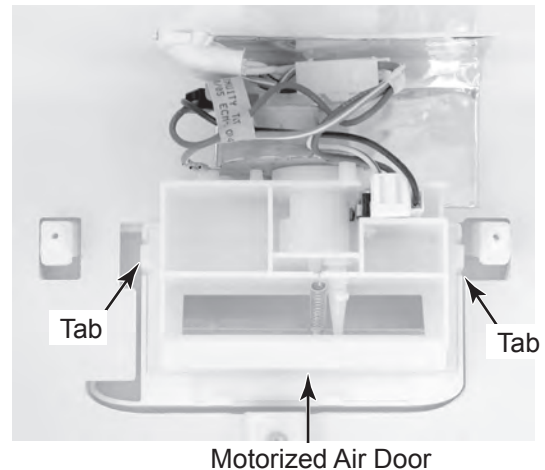

6. Disconnect the motorized air door connector from the wiring harness.
7. Remove the foam gasket from the liner.



REMOVING THE WATER DISPENSER SWITCH ASSEMBLY

⚠ WARNING



Electrical Shock Hazard

Disconnect power before servicing.

Replace all parts and panels before operating.

Failure to do so can result in death or electrical shock.

1. Unplug refrigerator or disconnect power.
2. Turn off the water supply to the refrigerator.
3. Open the refrigerator compartment doors and remove any items from around the water dispenser switch.

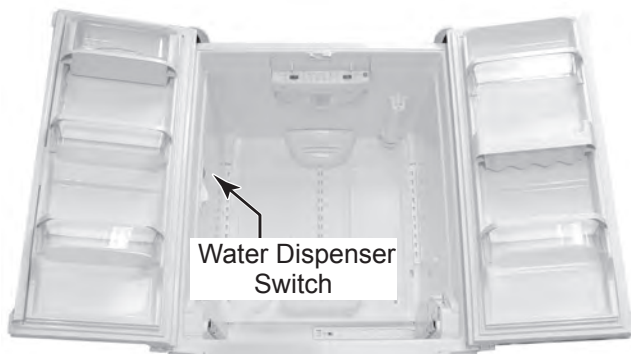

4. Slide the water dispenser screw cover up and remove it.
5. Remove the hex-head screw from the water dispenser.

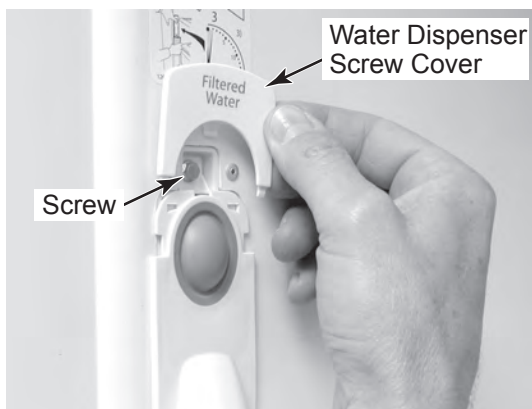

6. Pull the top of the water dispenser out and remove the water dispenser from the liner.
7. Disconnect the two wires from the dispenser switch terminals.
8. Push and release the locking tabs on the water dispenser switch, and pull the switch off the housing pins.

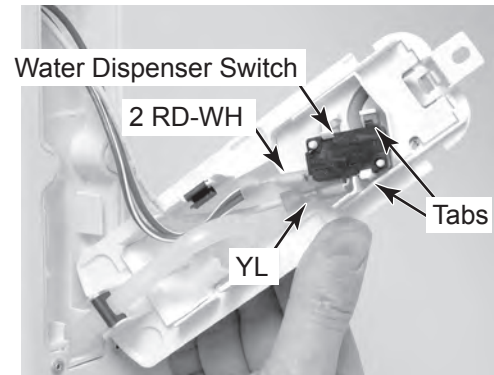

9. Disconnect the end of the water dispenser tube at the quick-disconnect coming from the water reservoir.

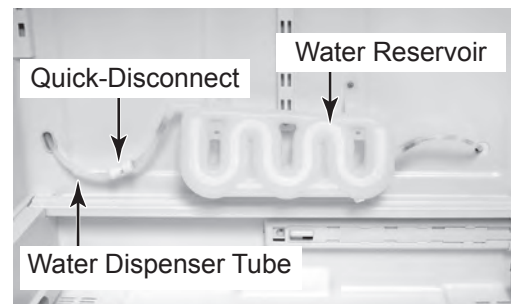

10. Remove the retaining clip and water tubing from the water dispenser housing and pull the end of the tube off the housing.
11. Pull the water dispenser tubing out of the channel in the refrigerator liner.

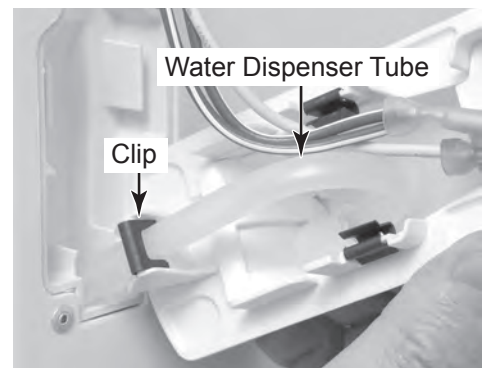

REMOVING THE WATER RESERVOIR

⚠️ WARNING



Electrical Shock Hazard

Disconnect power before servicing.

Replace all parts and panels before operating.

Failure to do so can result in death or electrical shock.

1. Unplug refrigerator or disconnect power.
2. Turn off the water supply to the refrigerator.
3. Open the refrigerator compartment doors and remove the items inside to access the water reservoir.

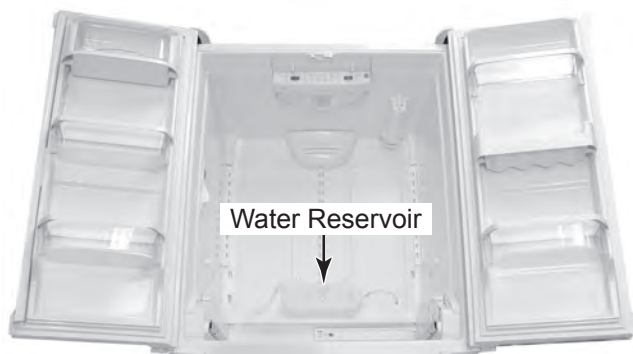

4. Remove the water dispenser tube from the quick-disconnect on the left side of the water reservoir, and drain any water from the tube into a container.

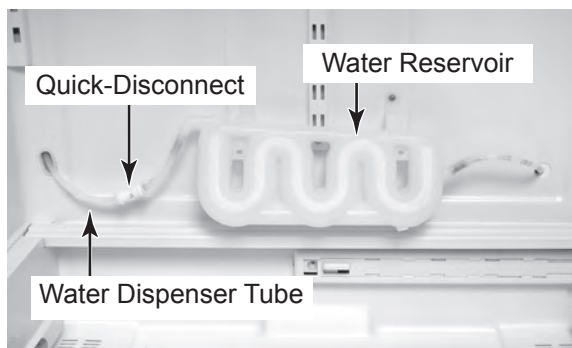

5. Pull the refrigerator away from the wall.
6. Remove the hex-head screw from the dual water valve tube clamp and remove the clamp from the tube.
7. Pull the end of the water tube from the quick-disconnect on the dual water valve.

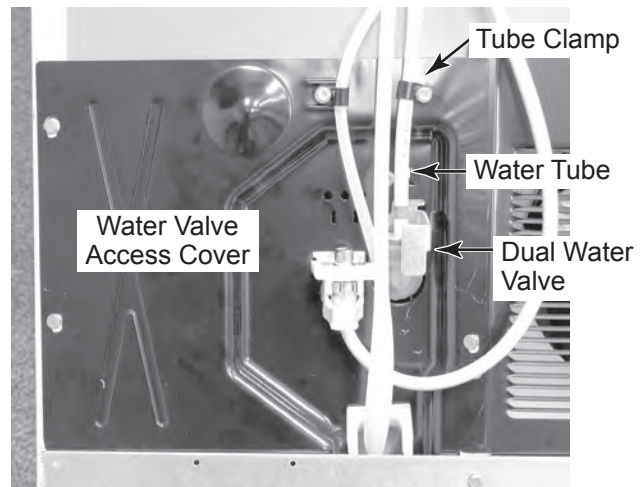

8. Remove the two hex-head screws from the water reservoir. **NOTE:** Be careful not to spill any of the water in the reservoir when removing it.

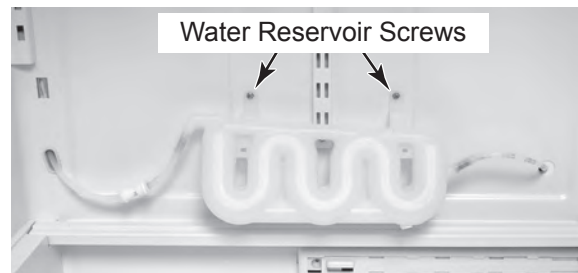

9. Pull the water reservoir tubing out of the channel in the refrigerator liner and remove the reservoir.



REMOVING THE WATER FILTER CONNECTOR

⚠ WARNING



Electrical Shock Hazard

Disconnect power before servicing.

Replace all parts and panels before operating.

Failure to do so can result in death or electrical shock.

1. Unplug refrigerator or disconnect power.
2. Turn off the water supply to the refrigerator.
3. Open the refrigerator compartment doors and remove the items inside to access the water filter.



4. Pull the refrigerator away from the wall.
5. Disconnect the water line from the fitting.

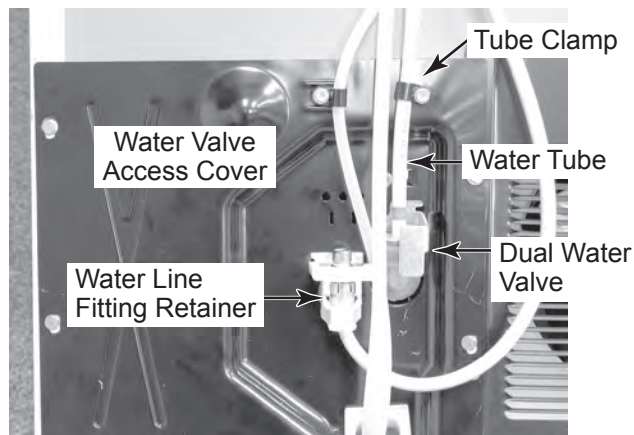

6. Squeeze the sides of the water line fitting retainer and slide the retainer off its bracket, then slide the fitting off the retainer.

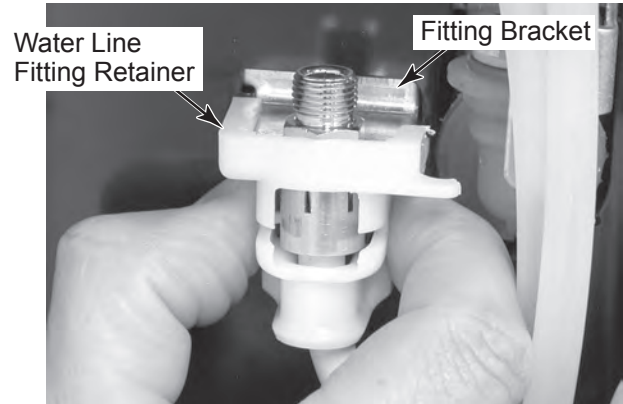

7. Remove the hex-head screw from the dual water valve tube clamp, and remove the clamp from the tube (see the lower left photo).
8. Pull the end of the water tube from the quick-disconnect on the dual water valve (lower left photo).
9. Pull the two lengths of water tubing out of the guides (see the photo below) on the rear of the refrigerator.
10. Carefully pull the foam block from the water tubing cutout.

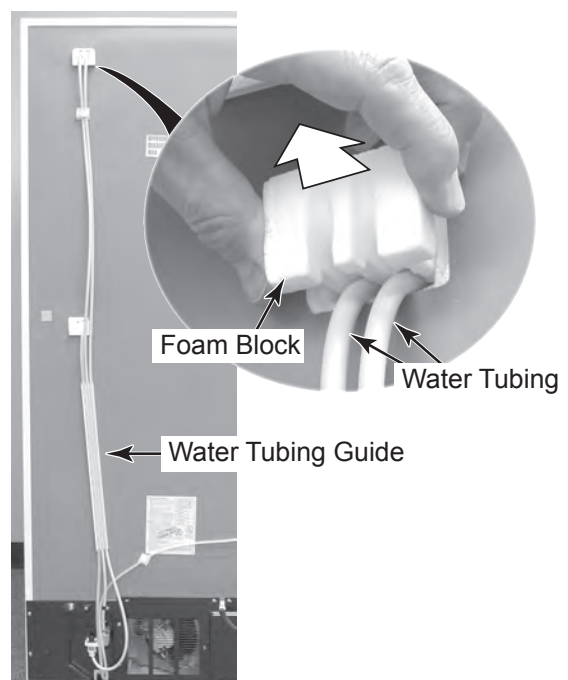

11. From inside the refrigerator compartment, turn the water filter 1/4-turn counterclockwise, and remove it from the connector.



13. Unsnap the left filter connector pin from the housing clip and remove the connector.

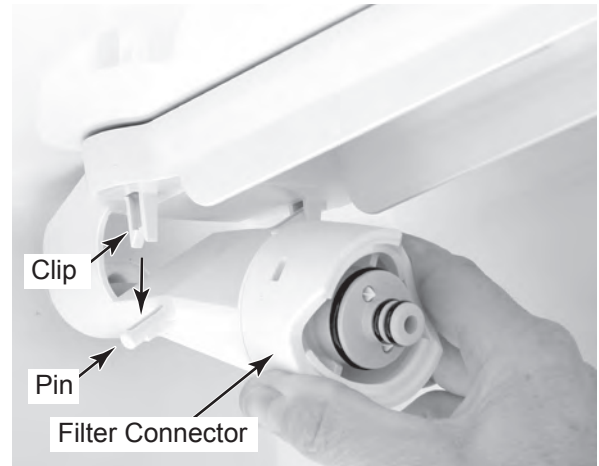

12. Unhook the cover from the filter housing and remove the cover.

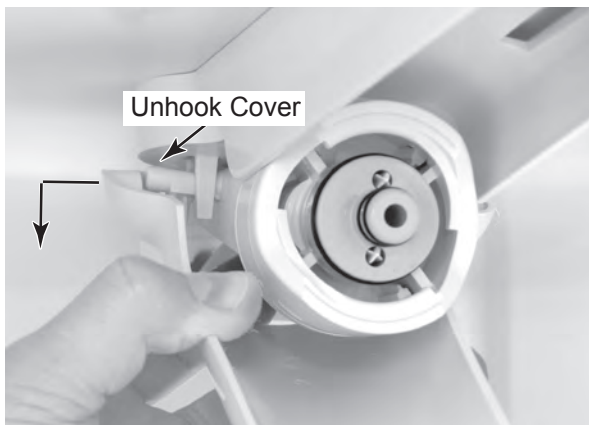

14. Pull the water tubing through the liner opening and remove the water filter connector.

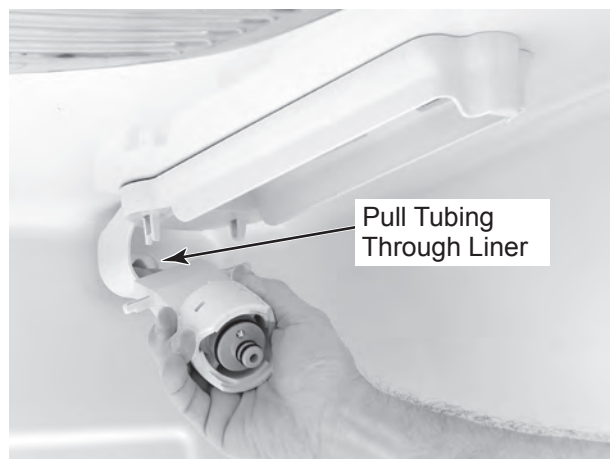

REMOVING THE FLIPPER MULLION

⚠ WARNING



Electrical Shock Hazard

Disconnect power before servicing.

Replace all parts and panels before operating.

Failure to do so can result in death or electrical shock.

1. Unplug refrigerator or disconnect power.
2. Open the refrigerator compartment doors.



3. Rotate the flipper mullion to its out position (see the top right photo).
4. Remove the hex-head screw from the mullion bracket.

Rotate Flipper Mullion Out →

Mullion Screw →

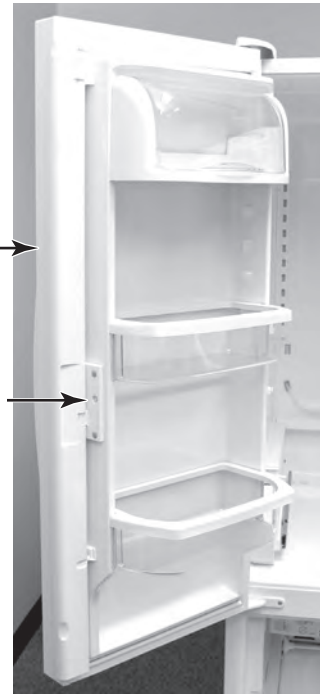

5. Lift the flipper mullion to unhook it from the door.
6. Disconnect the 3-wire flipper mullion connector from the harness.

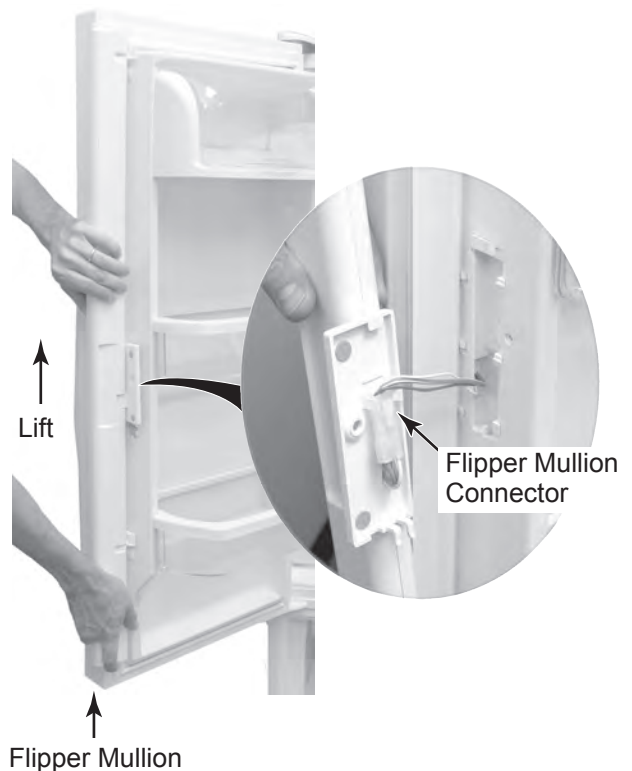

REMOVING THE FREEZER DOOR SWITCH & LIGHT SOCKET

⚠️ WARNING



Electrical Shock Hazard

Disconnect power before servicing.

Replace all parts and panels before operating.

Failure to do so can result in death or electrical shock.

1. Unplug refrigerator or disconnect power.
2. Open the freezer compartment.

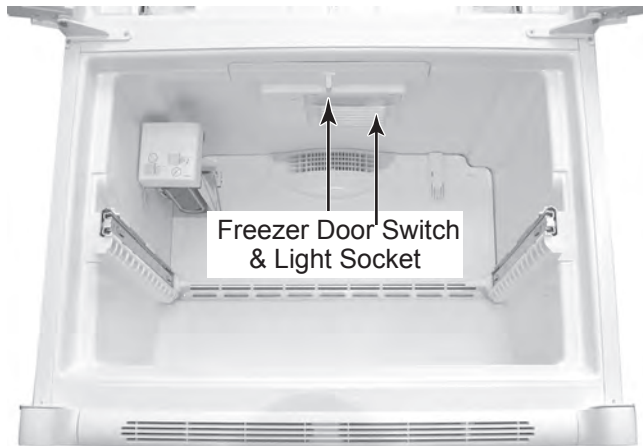

Freezer Door Switch & Light Socket

3. To remove the freezer door switch:

- a) Slide the end of a putty knife under the left flange of the freezer door switch, press it firmly against the locking tab of the switch, and pry the switch out of the liner.

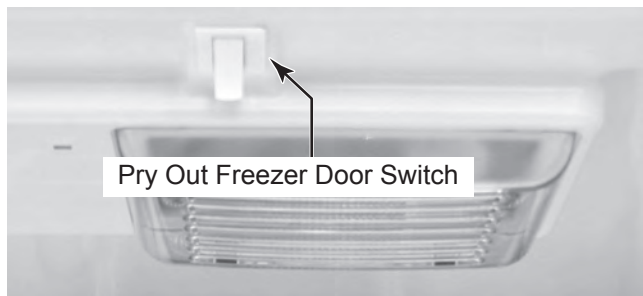

Pry Out Freezer Door Switch

- b) Disconnect the wires from the freezer door switch terminals and remove the switch.

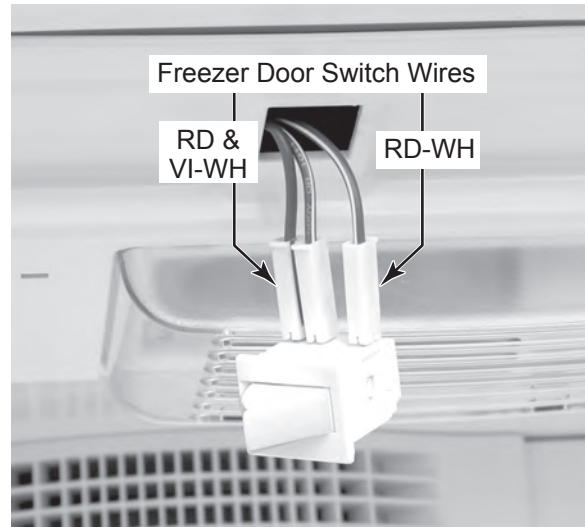

Freezer Door Switch Wires

RD & VI-WH

RD-WH

4. To remove the freezer light socket:

- a) Pull the back of the freezer light cover forward to release the two tabs, then pull down, and remove the cover.



Freezer Light Cover

- b) Remove the freezer bulb from the light socket.
- c) Remove the hex-head screw from the reflector and lower the reflector.

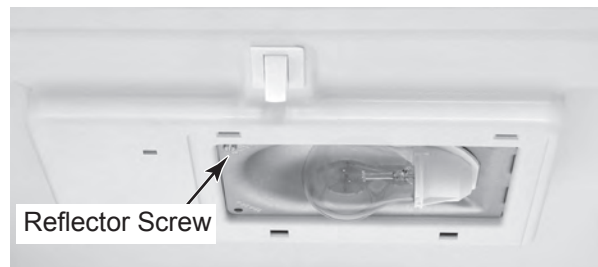

Reflector Screw

- d) Disconnect the two wires from the freezer light socket terminals.
- e) Press the locking tab to release the light socket, and remove the socket from the reflector. **NOTE:** If you are removing the reflector from the freezer, unclip the green ground wire.

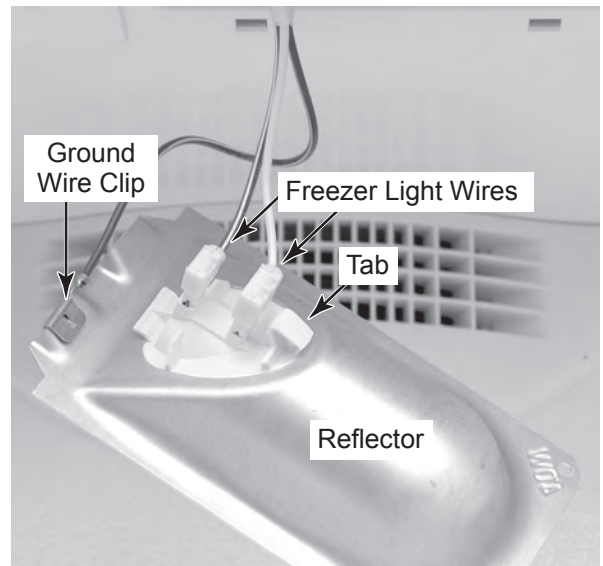

REMOVING THE FREEZER THERMISTOR

⚠ WARNING



Electrical Shock Hazard

Disconnect power before servicing.

Replace all parts and panels before operating.

Failure to do so can result in death or electrical shock.

1. Unplug refrigerator or disconnect power.
2. Open the freezer compartment and remove the items inside to access the thermistor.

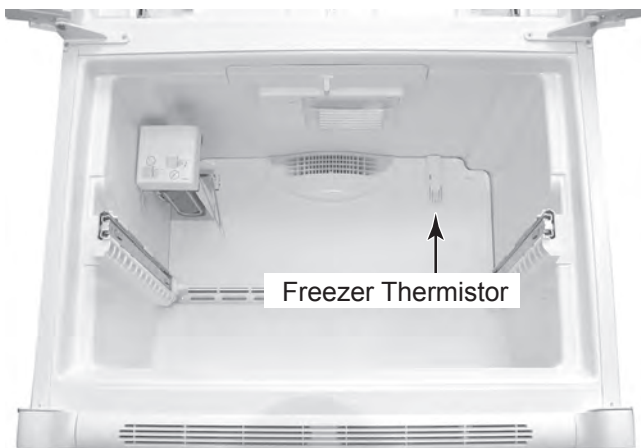

3. Place the tip of a flat-bladed screwdriver in the slot of the freezer thermistor cover, then move the screwdriver handle to the left to release the locking tab, and pull out on the left side of the cover to release it from the evaporator cover.

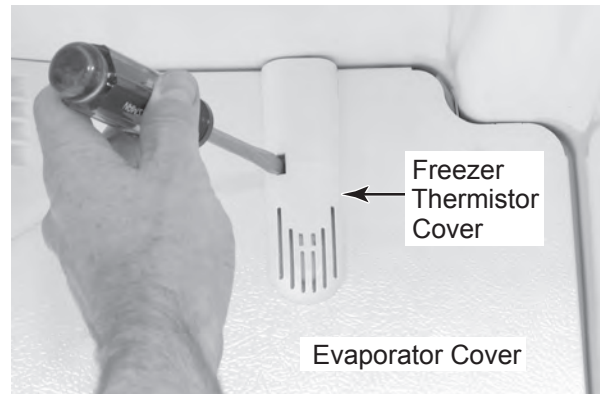

4. Unclip the freezer thermistor from the clips in the cover, and remove the thermistor.
5. Cut the freezer thermistor wires near the body.
6. Splice the ends of the wires from the replacement thermistor, to the ends of the wires you cut from the old thermistor in the previous step. **NOTE:** Trim the wire lengths, as necessary, so that they fit neatly into place when the thermistor cover is reinstalled.

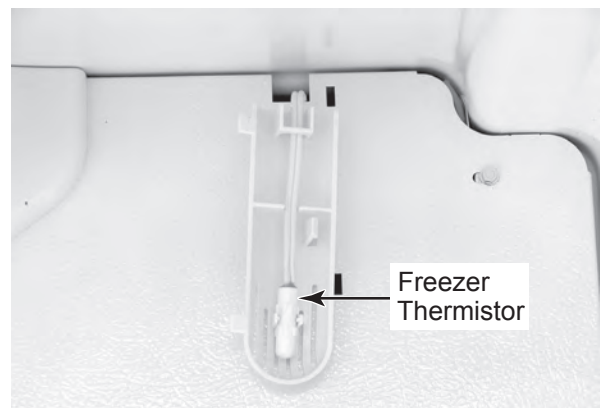

REMOVING THE ICE MAKER AND WATER FILL TUBE

⚠️ WARNING



Electrical Shock Hazard

Disconnect power before servicing.

Replace all parts and panels before operating.

Failure to do so can result in death or electrical shock.

1. Unplug refrigerator or disconnect power.
2. Open the freezer compartment and remove the items inside to access the ice maker.



3. **To remove the ice maker:**
 - a) Remove the three hex-head mounting screws from the freezer liner, (see the top right photo), and remove the ice maker.
 - b) Unlatch and disconnect the 4-wire power connector.

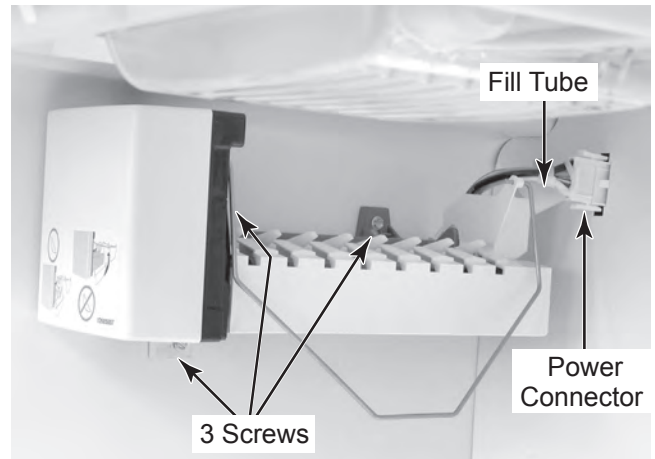

4. **To remove the water fill tube:**
 - a) Remove the ice maker (see step 3).
 - b) Turn off the water to the refrigerator.
 - c) Pull the refrigerator away from the wall.
 - d) Remove the two hex-head screws from the water fill tube cover on the rear panel.
 - e) Pull the water fill tube out of the freezer liner.
 - f) Release the tube from the clamp and pull the water tube off the fill tube.

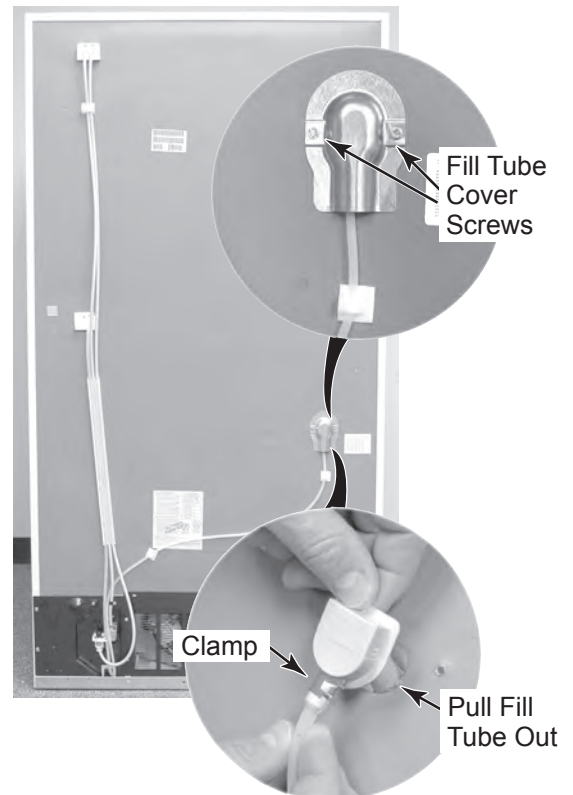

REMOVING THE EVAPORATOR FAN MOTOR, DEFROST BIMETAL, DEFROST HEATER, & EVAPORATOR

⚠ WARNING



Electrical Shock Hazard

Disconnect power before servicing.
Replace all parts and panels before operating.

Failure to do so can result in death or electrical shock.

1. Unplug refrigerator or disconnect power.
2. Open the freezer compartment and remove all of the items inside the compartment.

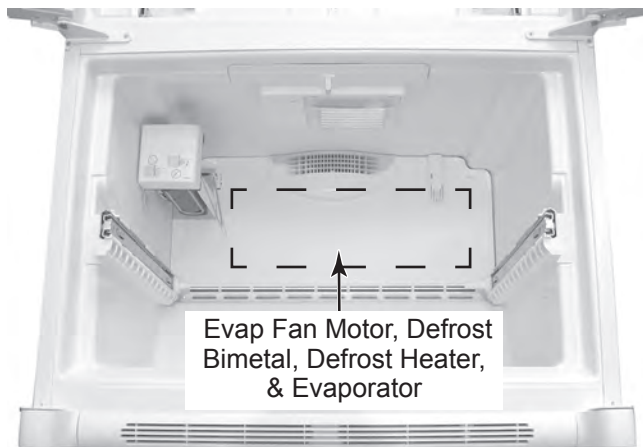

3. Remove the freezer thermistor (see page 4-12 for the procedure).
4. Remove the freezer basket and left and right freezer basket glides. Press the release lever to remove the glides.

5. Press the release arm on the left freezer basket glide, and pull the glide out of its support.



6. Remove the three hex-head screws from the left glide support and remove the support.

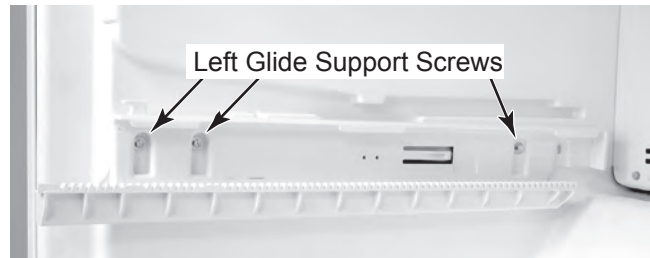

7. Press a screwdriver blade against the left, right, and then center air diffuser release tabs, and pull the diffuser off the evaporator cover.

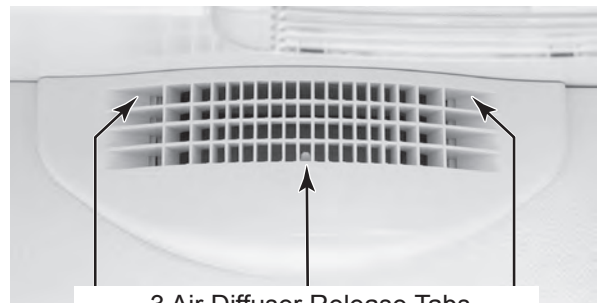

8. Press the locking tabs to release the ice maker power connector, and push the connector inside the evaporator cover opening.

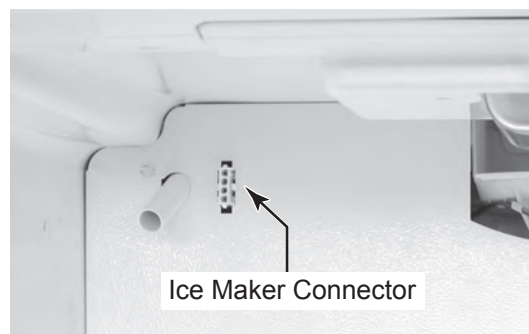

9. Remove the four hex-head screws from the evaporator cover and remove the cover from the freezer.

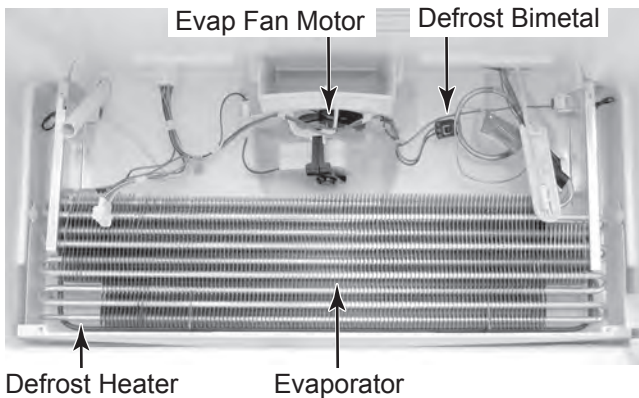
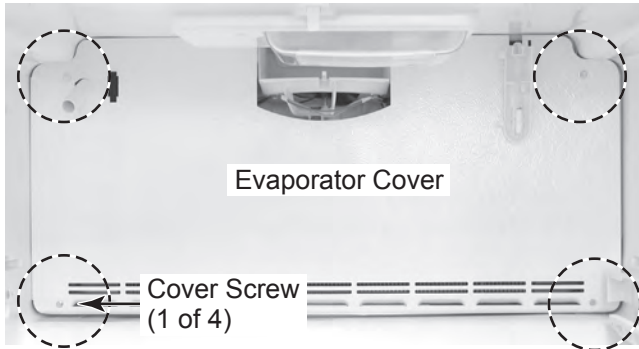

10. **To remove the evaporator fan motor:**

- a) Disconnect the main wire harness connector from the fan motor connector.
- b) Release the locking tabs on the fan motor connector, and remove the fan motor from the housing.
- c) Pull the fan blade off the motor shaft.

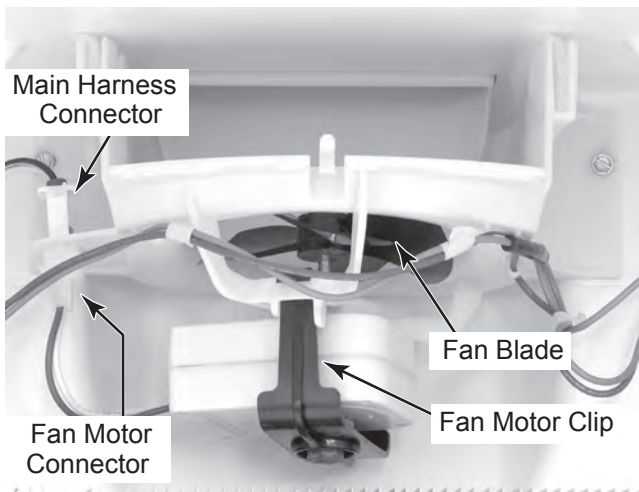

- d) Unclip the fan motor from the housing and remove the clip, (see the lower left photo), then pull the bottom of the fan motor out, and remove the motor.

11. **To remove the defrost bimetal:**

- a) Pull the bimetal and unclip it from the tubing.

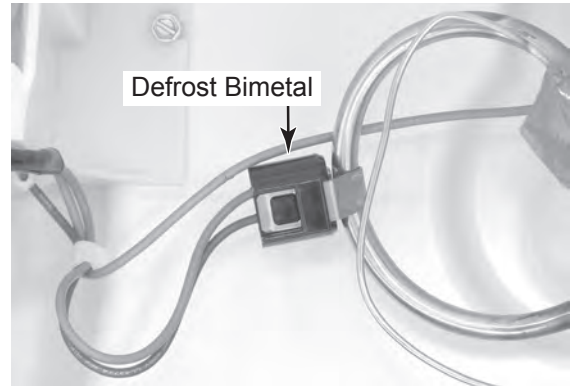

- b) Cut the wires on the old bimetal near the body.
- c) Splice the ends of the wires from the replacement bimetal, to the ends of the wires you cut from the old bimetal in the previous step. **NOTE:** Trim the wire lengths, as necessary, so that they fit neatly into place when the new bimetal is installed on the evaporator.

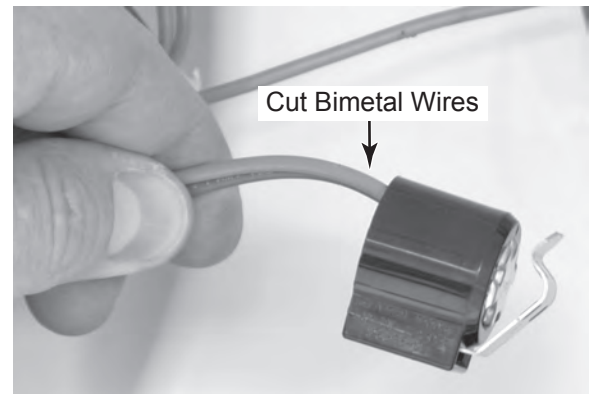

Continued on the next page.

12. To remove the defrost heater & evaporator:

- a) Disconnect the left and right main harness wire connectors from the heater connectors.
- b) Unsnap the heater wire connectors from the left and right air dams.

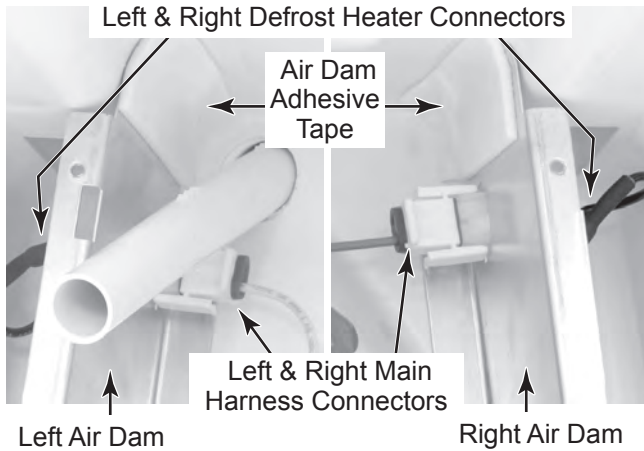

- c) Remove the hex-head screws from the left and right air dams.



Left Air Dam Screw Right Air Dam Screw

- d) Grasp the evaporator tubing at the right corner, and forcefully jerk the tubing forward to disengage the tubing from the plastic standoff (see inset).
- e) Repeat the previous step, and disengage the left side of the evaporator tubing from its plastic standoff.

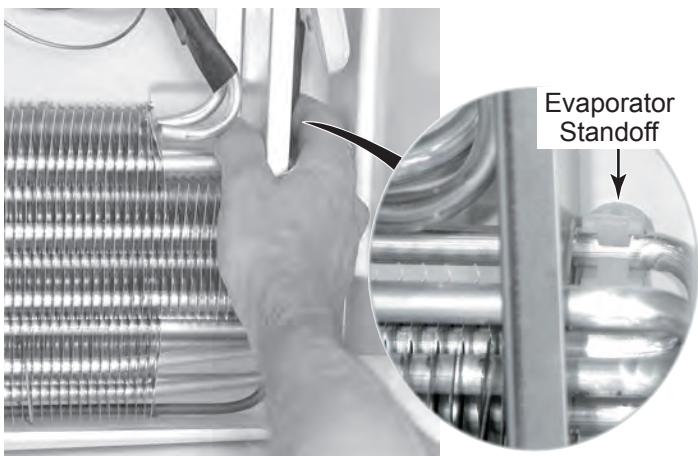

- f) Pull the bottom of the evaporator out and rotate it up several inches. **IMPORTANT:** When you rotate the evaporator, allow the copper tubing to bend, and not the evaporator tubing shown below.

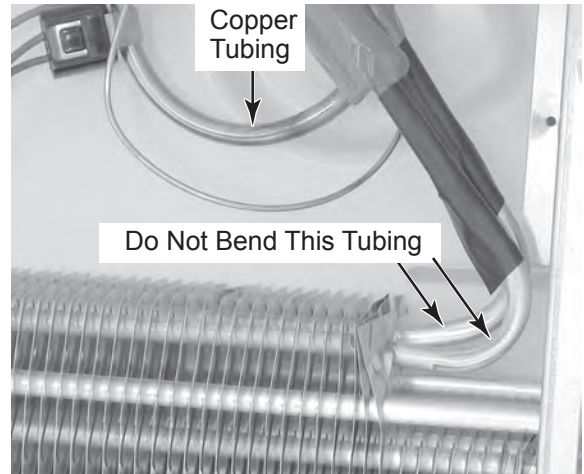

- g) Carefully pull the adhesive foam tape, on the left and right air dams, (see the top left photo), off the freezer liner.
- h) Continue to rotate the bottom of the evaporator up until it is high enough to access the bottom of the defrost heater, and prop it up.
- i) Remove the two heater clips from the bottom of the evaporator.
- j) Pull the defrost heater off the evaporator and remove it.

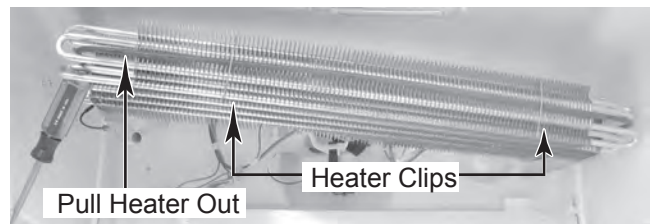

REASSEMBLY NOTE: Make sure that when you reinstall the evaporator, the air dam tape is pressed tightly against the freezer liner. If it is not properly installed, there will be air leaks that can cause operational problems.

REMOVING THE DUAL WATER VALVE

⚠ WARNING



Electrical Shock Hazard

Disconnect power before servicing.

Replace all parts and panels before operating.

Failure to do so can result in death or electrical shock.

1. Unplug refrigerator or disconnect power.
2. Turn off the water supply to the refrigerator.
3. Pull the refrigerator away from the wall so that you can access the rear of the unit.
4. Disconnect the water line from its fitting.
5. Remove the four hex-head screws from the water valve access cover, but do not remove the cover at this time.

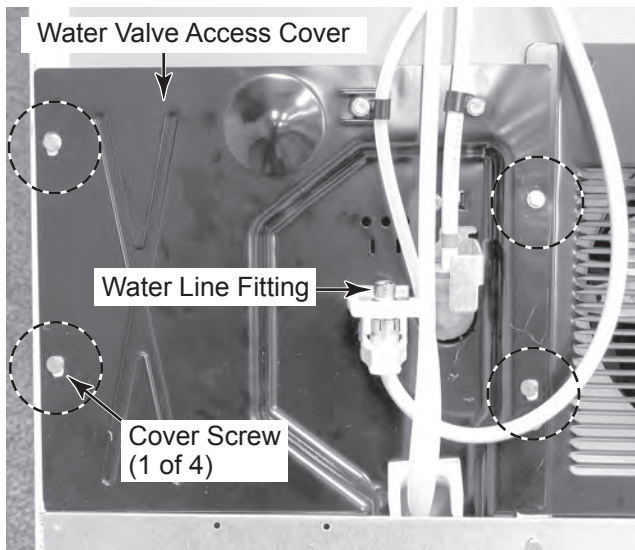

6. Squeeze the sides of the water line fitting retainer and slide the retainer off its bracket.

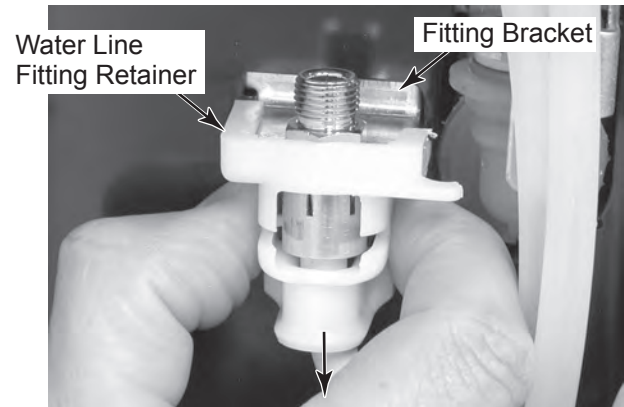

7. Slide the water line fitting off the retainer.

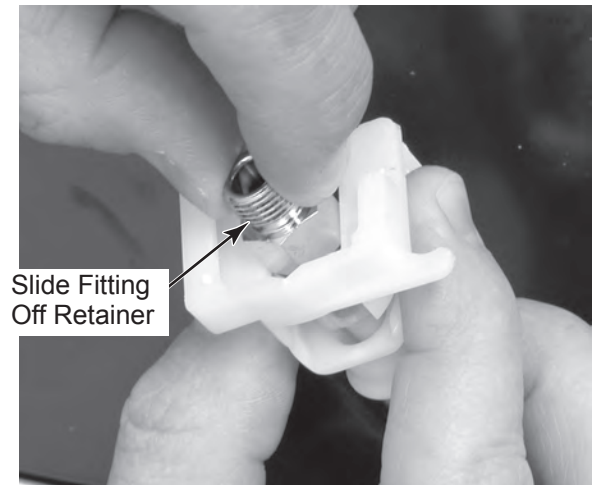

Continued on the next page.

8. Remove the hex-head screw from the tube clamp on the water tube, and remove the clamp from the tube.
9. Pull the end of the water tube from the quick-disconnect on the dual water valve.
10. Remove the hex-head screw from the dual water valve bracket.

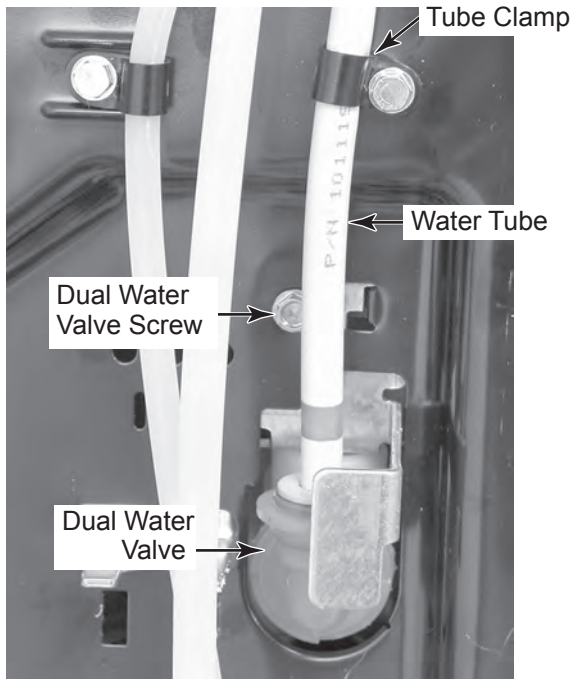

11. Pull the water valve access cover out from the rear of the unit and position it so you can access the dual water valve.
12. Remove the dual water valve from the access cover.
13. Disconnect the yellow and brown wire connectors from the dual water valve terminals. **NOTE:** The connectors and valve terminals are polarized so they cannot be interchanged.
14. Pull the water tubing out of the dual water valve quick-disconnects and remove the valve.

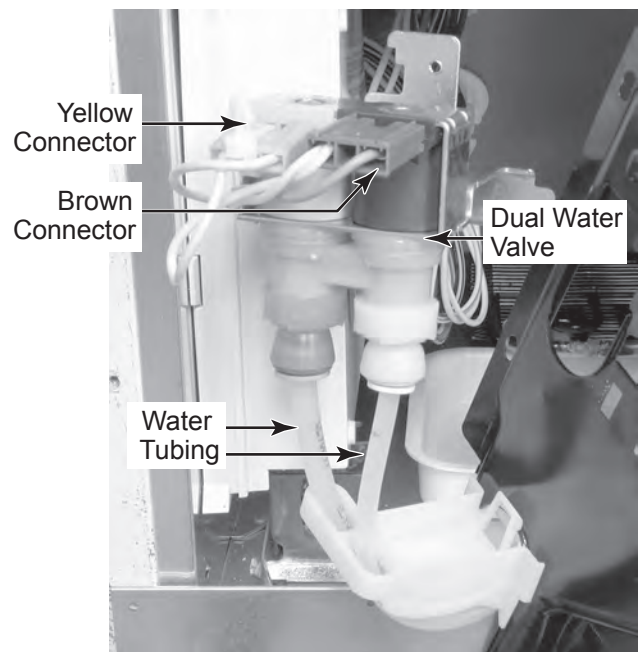

REMOVING THE MAIN ELECTRONIC CONTROL BOARD

⚠ WARNING



Electrical Shock Hazard

Disconnect power before servicing.

Replace all parts and panels before operating.

Failure to do so can result in death or electrical shock.

1. Unplug refrigerator or disconnect power.
2. Turn off the water supply to the refrigerator.
3. Pull the refrigerator away from the wall so that you can access the rear of the unit.
4. Disconnect the water line from its fitting.
5. Remove the four hex-head screws from the water valve access cover, remove the cover, and position it out of the way.

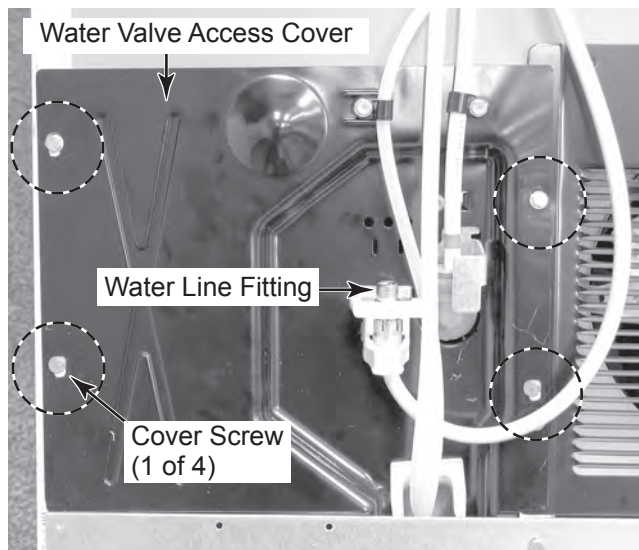

6. Push down on the release arm and slide the main electronic control board housing out of the unit (see the top right photo).

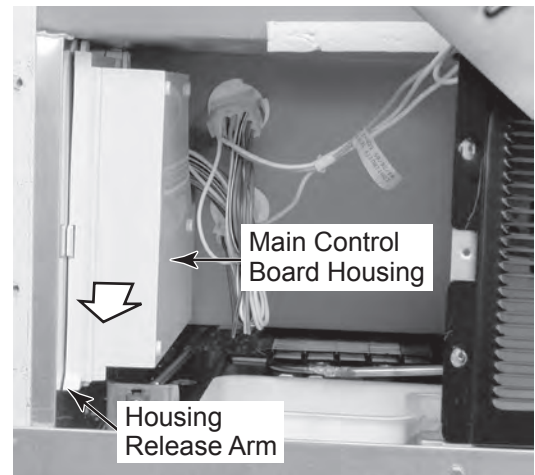

7. Turn the housing over so you can access the board wire connectors.
8. Remove the three wire connectors from the board at J2, J3, and J4.
9. Remove the two mounting screws for the main electronic control board.

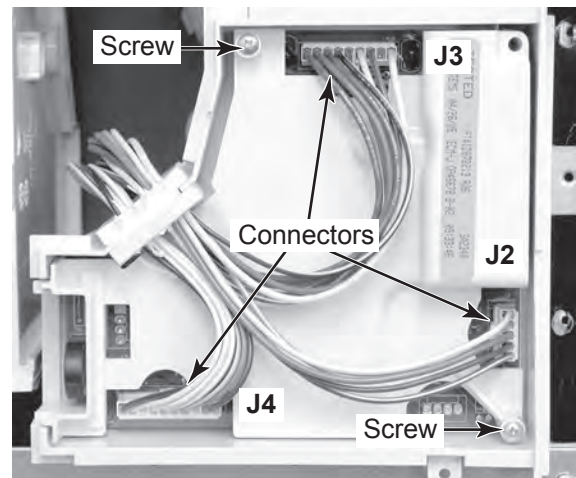

10. Turn the housing over and remove the main electronic control board.

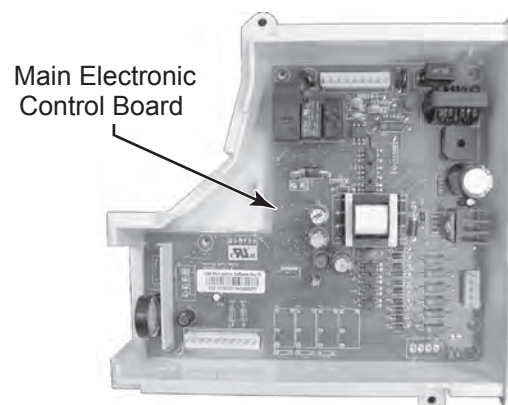

REMOVING THE CONDENSER FAN MOTOR

⚠ WARNING



Electrical Shock Hazard

Disconnect power before servicing.

Replace all parts and panels before operating.

Failure to do so can result in death or electrical shock.

1. Unplug refrigerator or disconnect power.
2. Pull the refrigerator away from the wall so that you can access the rear of the unit.
3. Remove the six hex-head screws from the unit compartment cover. Remove the cover and slide the power supply cord strain relief out of the slot in the cover.

Power Supply Cord

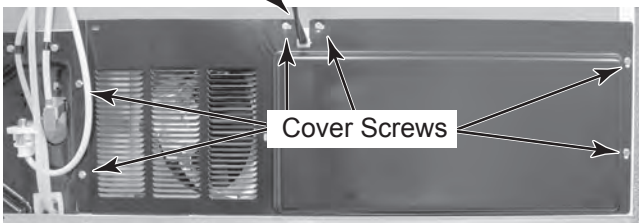

Condenser Fan Motor

4. Disconnect the power connector from the condenser fan motor.
5. Remove the three hex-head screws from the condenser fan motor and remove the motor.

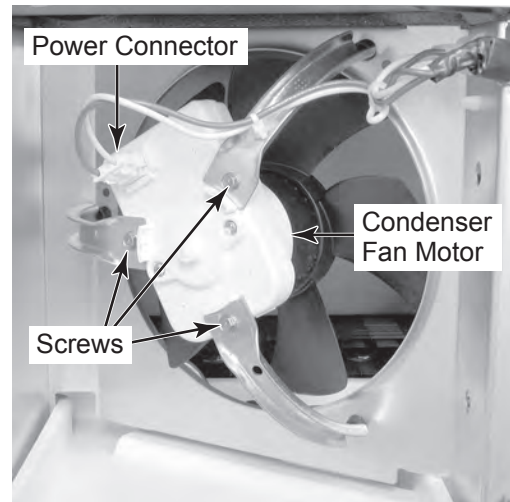

6. Pull the fan blade off the condenser fan motor shaft.



REMOVING THE COMPRESSOR

⚠ WARNING



Electrical Shock Hazard

Disconnect power before servicing.

Replace all parts and panels before operating.

Failure to do so can result in death or electrical shock.

1. Unplug refrigerator or disconnect power.
2. Pull the refrigerator away from the wall so that you can access the rear of the unit.
3. Remove the six hex-head screws from the unit compartment cover. Remove the cover and slide the power supply cord strain relief out of the slot in the cover.

Power Supply Cord

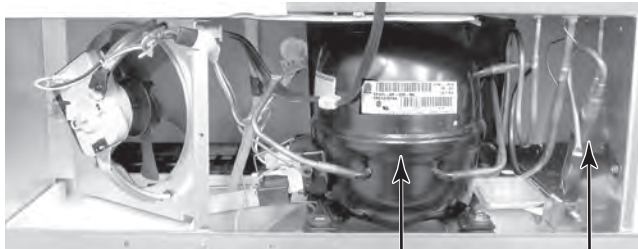
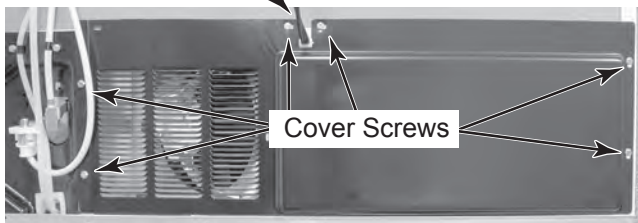

Compressor Filter-Drier

4. Unclip the retaining wire from the overload relay and the motor start capacitor, (see the inset in the top right photo), then pull the relay and capacitor off the compressor pins.
5. Remove the hex-head screw from the green ground wire.

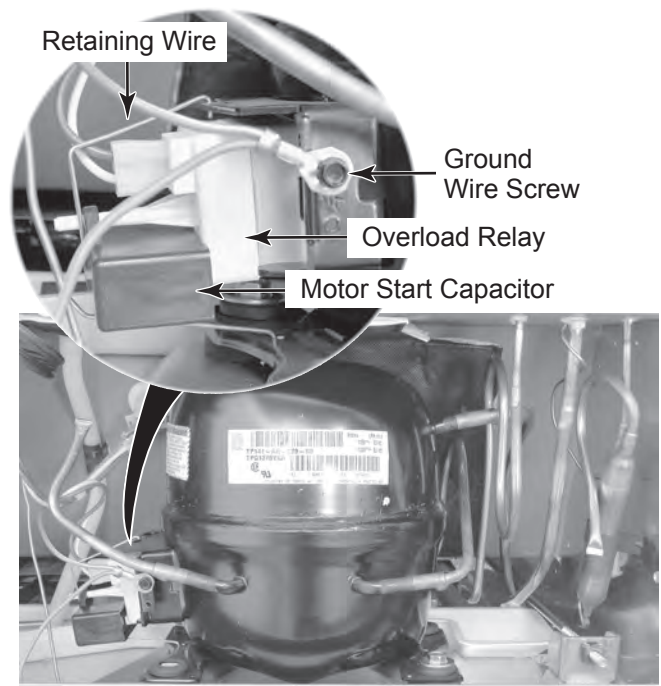

6. Access the sealed system and discharge the refrigerant into an approved recovery system.
7. Unbraid the suction and discharge lines from the compressor.
8. Cut the filter-drier (do not use a torch) from the system.
9. Remove the two 5/16" mounting bolts from the rubber grommets of the compressor.
10. Lift the old compressor off the refrigerator and install the new one.

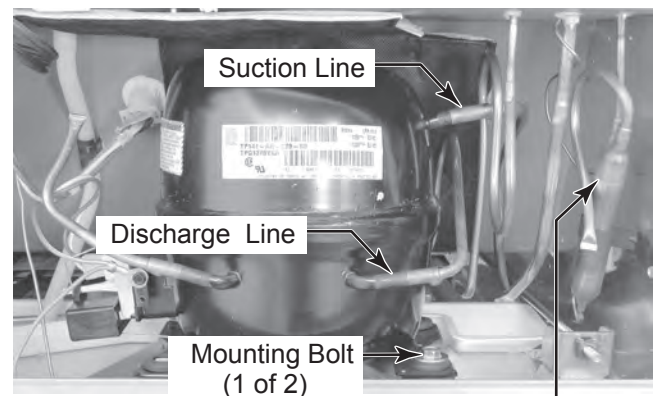

Filter-Drier

REMOVING THE POWER SUPPLY CORD

⚠ WARNING



Electrical Shock Hazard

Disconnect power before servicing.

Replace all parts and panels before operating.

Failure to do so can result in death or electrical shock.

1. Unplug refrigerator or disconnect power.
2. Pull the refrigerator away from the wall so that you can access the rear of the unit.
3. Remove the six hex-head screws from the unit compartment cover. Remove the cover and slide the power supply cord strain relief out of the slot in the cover.

Power Supply Cord

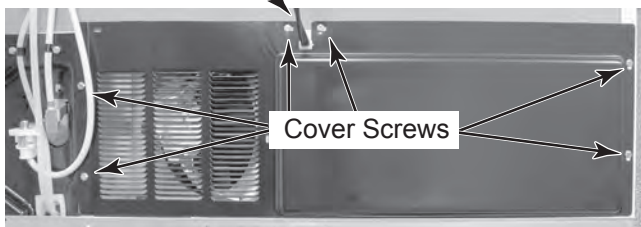

4. Release the locking arms, and disconnect the power supply cord connector from the main harness.
5. Remove the hex-head screw from the green ground wire and remove the power supply cord.

Power Supply Cord Connector

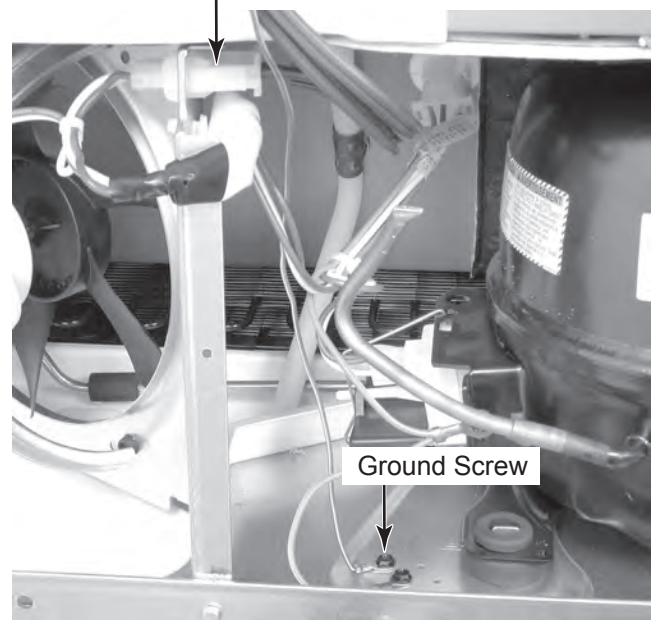

REMOVING THE FRONT AND REAR ROLLERS

⚠ WARNING



Electrical Shock Hazard

Disconnect power before servicing.

Replace all parts and panels before operating.

Failure to do so can result in death or electrical shock.

1. Unplug refrigerator or disconnect power.
2. Pull the refrigerator away from the wall.
3. Unsnap and remove the air grille from the refrigerator.
4. Pull the front roller cover off the roller you are removing.



5. To remove a front roller:

- a) Tilt the refrigerator back approximately 3" and prop the front up.
- b) Turn the silver (outer) leveling screw to the left (counterclockwise) and remove the threaded end from the front roller.



Front Roller Leveling Screw

- c) Rotate the front roller so that the bracket tab aligns with the chassis slot, and remove the roller.

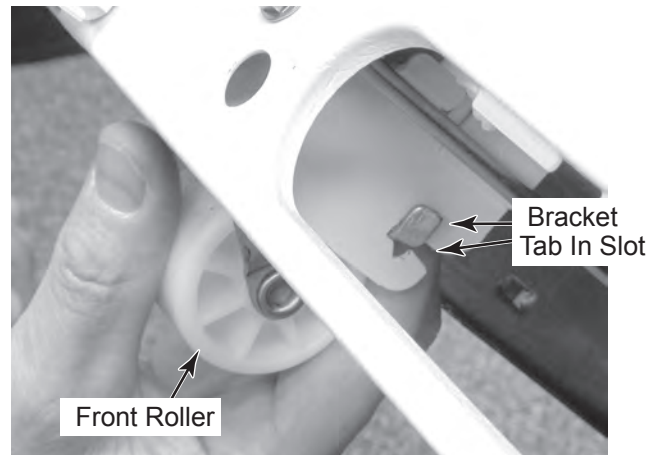

6. To remove a rear roller:

- a) Tape the refrigerator doors closed.
- b) Tilt the refrigerator forward approximately 4" and prop the back up.

Continued on the next page.

- c) Turn the gold (inner) leveling screw to the left (counterclockwise), and remove the threaded rod from the rear roller you are removing.



Rear Roller Leveling Screw

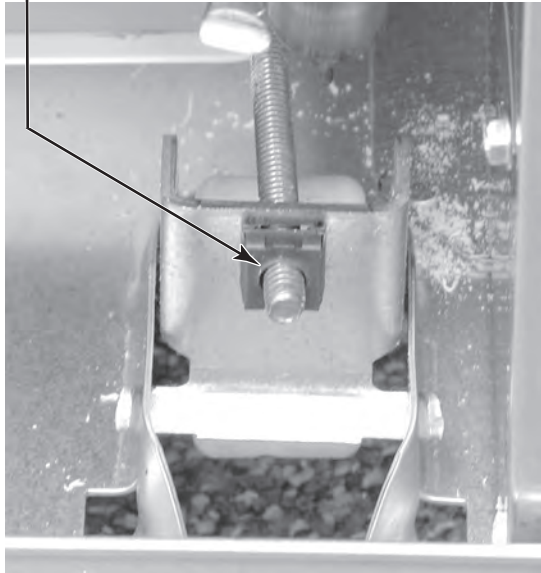

- d) Rotate the rear roller so that the bracket tab aligns with the chassis slot, and remove the roller.

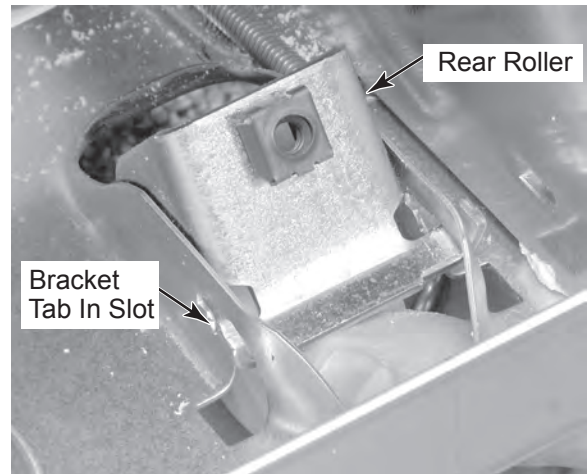

REMOVING THE CONDENSATE DRAIN PAN & CONDENSER

⚠ WARNING



Electrical Shock Hazard
Disconnect power before servicing.
Replace all parts and panels before operating.
Failure to do so can result in death or electrical shock.

1. Unplug refrigerator or disconnect power.
2. Pull the refrigerator away from the wall so that you can access the rear of the unit.
3. Tape the refrigerator doors closed.
4. Tilt the refrigerator forward approximately 6" and prop the back up.
5. Remove the six hex-head screws from the unit compartment cover, then remove the cover, and slide the power supply cord strain relief out of the cover slot.
6. Remove the rear torx screws from the base pan and the front torx screws from the bottom of the cabinet.
7. Carefully lower the base pan. Be careful not to kink the compressor or condenser tubing.
8. **To remove the condensate drain pan:**
 - a) Remove the hex-head screws that mount the condenser fan motor housing to the base pan.
 - b) Lift the condenser fan motor housing up so that it clears the condensate drain pan.
 - c) Remove the condensate drain pan from the unit.
9. **To remove the condenser:**
 - a) Remove the condensate drain pan from the unit (see step 8).
 - b) Unbrazed the tubing to the PC loop and the heat exchanger.
 - c) Disconnect all of the unit compartment wiring at the Molex connector (see the lower left photo).
 - d) Unbrazed the discharge and condenser.
 - e) Unsnap the condenser from the base pan.

Power Supply Cord

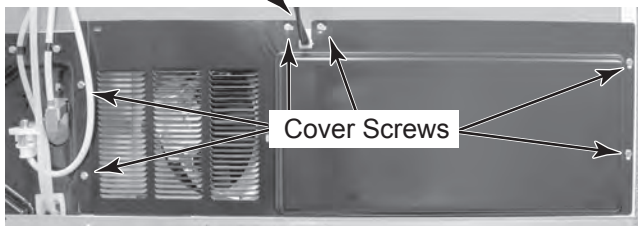

Unit Compartment

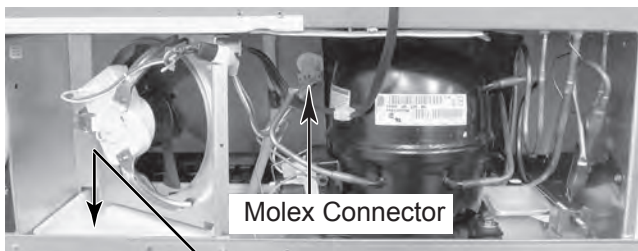

Condensate Drain Pan

Condenser Fan Motor

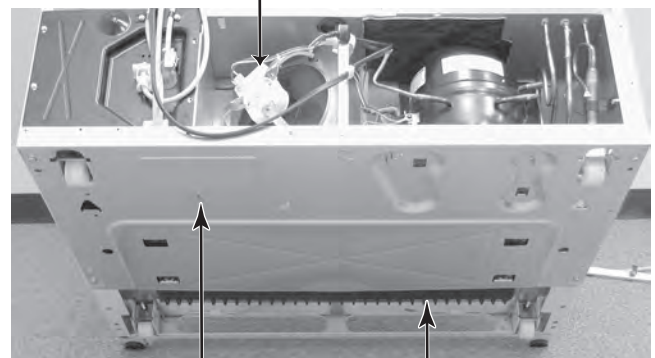

Base Pan

Condenser

— NOTES —

COMPONENT TESTING

Before testing any of the components, perform the following checks:

- The most common cause for control failure is corrosion on connectors. Therefore, disconnecting and reconnecting wires will be necessary throughout test procedures.
- All tests/checks should be made with a VOM or DVM having a sensitivity of 20,000 ohms-per-volt DC, or greater.
- Check all connections before replacing components, looking for broken or loose wires, failed terminals, or wires not pressed into connectors far enough.
- Resistance checks must be made with power cord unplugged from outlet, and with wiring harness or connectors disconnected.



⚠ WARNING

Electrical Shock Hazard

Disconnect power before servicing.

Replace all parts and panels before operating.

Failure to do so can result in death or electrical shock.

REFRIGERATOR & FREEZER DOOR SWITCHES

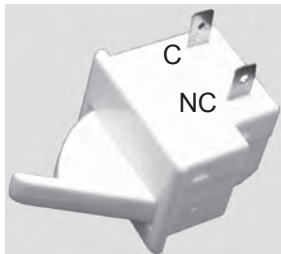

Refrigerator Door Switch

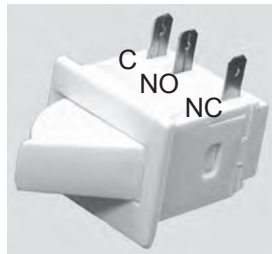

Freezer Door Switch

Refer to pages 4-2 or 4-10 for the procedures for accessing the refrigerator and freezer door switches.

1. Unplug refrigerator or disconnect power.
2. Disconnect the wires from the door switch terminals.
3. Set the ohmmeter to the R x 1 scale.
4. **Refrigerator Door Switch:** Touch the ohmmeter test leads to the C and NC door switch terminals. The meter should indicate a closed circuit (0 Ω). Press the actuator arm and the meter should indicate an open circuit (infinite).
5. **Freezer Door Switch:** Touch the ohmmeter test leads to the indicated terminals. The meter should indicate as follows:
 - a) C and NC = closed circuit (0 Ω).
 - b) C and NO = open circuit (infinite)
 - c) Press the actuator arm and the meter indications in steps 5a and 5b should change states.



⚠ WARNING

Electrical Shock Hazard

Disconnect power before servicing.

Replace all parts and panels before operating.

Failure to do so can result in death or electrical shock.

WATER DISPENSER SWITCH

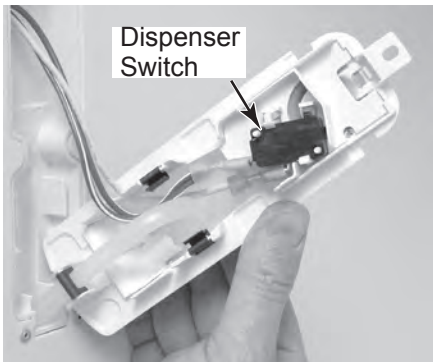

Refer to page 4-5 for the procedure for accessing the water dispenser switch.

1. Unplug refrigerator or disconnect power.
2. Disconnect the wires from the switch terminals.
3. Set the ohmmeter to the R x 1 scale.
4. Touch the ohmmeter test leads to the dispenser switch terminals. The meter should indicate an open circuit (infinite).
5. Press the actuator button on the switch, and the meter should indicate a closed circuit (0 Ω).

FLIPPER MULLION



Refer to page 4-9 for the procedure for accessing the flipper mullion.

1. Unplug refrigerator or disconnect power.
2. Disconnect the mullion connector from the wiring harness.
3. Set the ohmmeter to the R x 1K scale.
4. Touch the ohmmeter test leads to the mullion connector pins. The meter should indicate between 1350 and 1500 Ω .



⚠️ WARNING

Electrical Shock Hazard

Disconnect power before servicing.

Replace all parts and panels before operating.

Failure to do so can result in death or electrical shock.

DEFROST HEATER

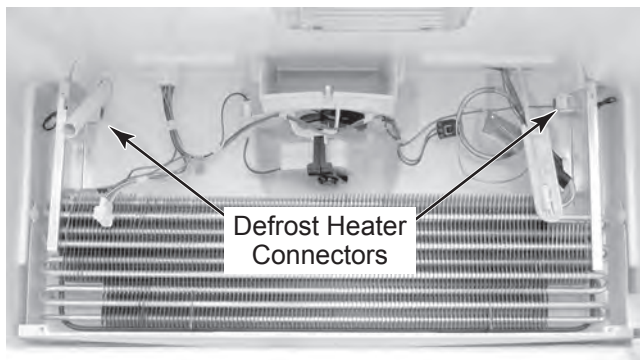

Refer to page 4-14 for the procedure for accessing the defrost heater.

1. Unplug refrigerator or disconnect power.
2. Disconnect the defrost heater wire connectors from the main harness.
3. Set the ohmmeter to the R x 1 scale.
4. Touch the ohmmeter test leads to the heater connector terminals. The meter should indicate between 20 and 40 Ω .

DUAL WATER VALVE

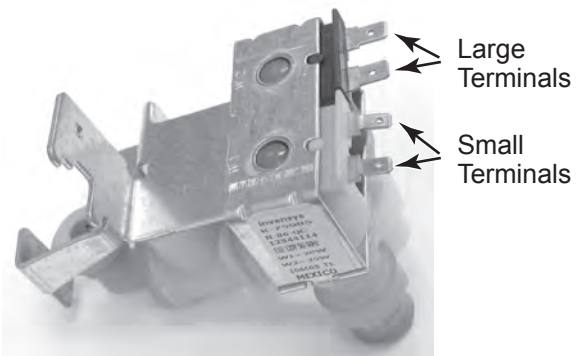

Refer to page 4-17 for the procedure for accessing the dual water valve.

1. Unplug refrigerator or disconnect power.
2. Disconnect the wire connectors from the dual water valve terminals.
3. Set the ohmmeter to the R x 1 scale.
4. Touch the ohmmeter test leads to the indicated water valve solenoid terminals. The meter should indicate as follows:
 - a) Small terminals (yellow connector) = 200 to 300 Ω .
 - b) Large terminals (brown connector) = 150 to 250 Ω .



⚠ WARNING

Electrical Shock Hazard

Disconnect power before servicing.

Replace all parts and panels before operating.

Failure to do so can result in death or electrical shock.

COMPRESSOR

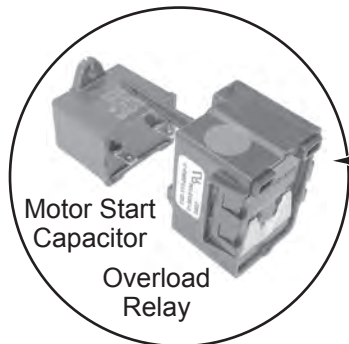

Refer to page 4-21 for the procedure for accessing the compressor.

1. Unplug refrigerator or disconnect power.
2. Remove the overload relay and motor start capacitor from the compressor terminals.
3. Set the ohmmeter to the R x 1 scale.
4. **To test the compressor**, touch the ohmmeter test leads to the indicated compressor pins. The meter should indicate as follows:
 - a) Run (R) to common (C) = 3.3 Ω .
 - b) Start (S) to common (C) = 4.3 Ω .
5. **To test the motor start capacitor**, set the ohmmeter to the 10K scale. Touch the ohmmeter test leads to the capacitor terminals. The meter should indicate several ohms, and then gradually return to infinity.

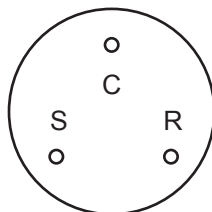

Compressor Pinouts

DIAGNOSTICS & TROUBLESHOOTING

DIAGNOSTIC TESTS

PROGRAMMING MODE: (FOR PROGRAMMING A NEW CONTROL)

NOTE: The Program Code is located on the Serial Plate on this unit after the word Code.

1. Open the Fresh Food door and press and hold the Door Alarm Keypad.
2. Press and hold Freezer Temperature Down Keypad .
3. Release the Door Alarm Keypad and wait 3 seconds.
4. The control will display PE to indicate the programming mode.

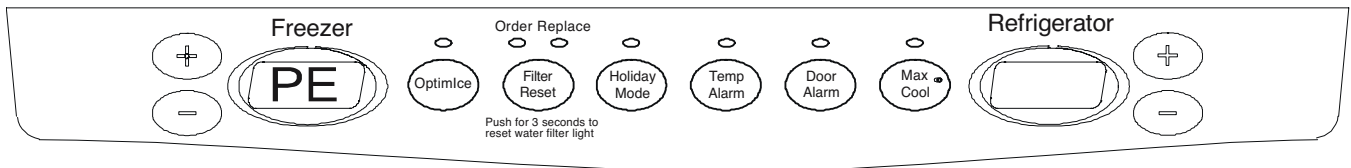

5. Entry is confirmed by pressing the Freezer Temperature Down Keypad once more.
6. The control will display the current Program Code. This value should be validated with the Program Code printed on the unit serial plate.

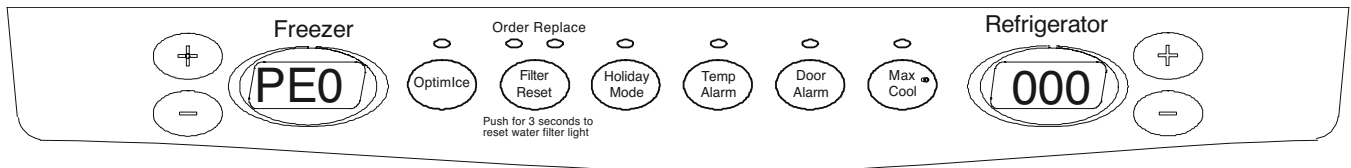

NOTE: If the Program Code is correct, the Programming Mode is exited by closing the Refrigerator door(s).

7. Press the Refrigerator Temperature Up Keypad or Refrigerator Down Keypad to change the digit value with each key press.
8. The decimal point indicates the selected digit. Press the Freezer Temperature Up Keypad to select the next digit.
9. Once the desired Program Code is entered, press and hold the Freezer Temperature Down Keypad until the Program Code begins flashing indicating it has been saved.

NOTE: If you attempt to enter an invalid Program Code the control will not save the new code, but will beep. (The unit will NOT run with a Program Code of 0000). Once the Program Code has been saved, the Programming Mode is exited by closing the Refrigerator door(s). If the new code is incorrect this process should be repeated after closing the Refrigerator door(s).

The Programming mode can be exited at any time by closing the Refrigerator Door(s) or will exit if unattended for four minutes.

DEFROST OPERATION

The Control Board adapts the compressor run time between defrosts to achieve optimum defrost intervals by monitoring the length of time the defrost heater is on. After initial power up, defrost interval is 4 hours compressor run time. Defrost occurs immediately after the 4 hours has elapsed.

FORCED DEFROST MODE

The forced defrost function is performed using the Freezer display and Refrigerator keypad. Enter the Forced Defrost Mode by performing the following sequence of events:

1. Open the Fresh Food door and press and hold the Door Alarm Keypad.
2. Press and hold Refrigerator Temperature Down Keypad.
3. Release the Door Alarm Keypad and wait 3 seconds. Fd appears in left display.

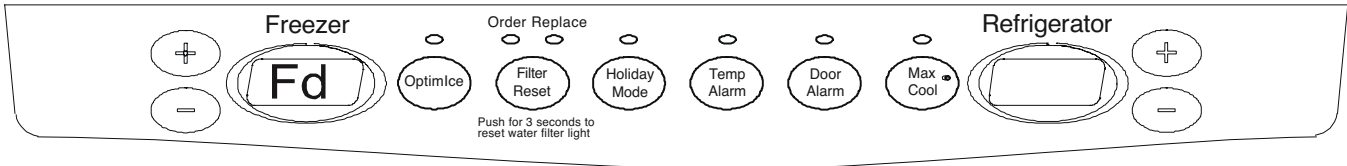

4. Press the Refrigerator Down Keypad again. SH appears in right display.
5. Press the Refrigerator Down Keypad again to force defrost. Fd and SH will flash in the display indicating that the unit is in defrost.

SERVICE TEST MODE

The service test functions are performed using the refrigerator display and keypad. Enter the Service Test Mode by performing the following sequence of events.

1. Open the Fresh Food door and press and hold the Door Alarm Keypad.
2. Press and hold Refrigerator Temperature Up Keypad.
3. Release the Door Alarm Keypad and wait 3 seconds.

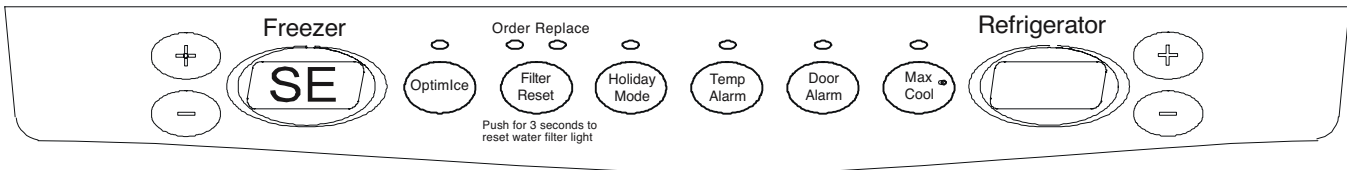

4. Press the Refrigerator Up Keypad again.
5. Display will show 001 in left display and numeric or dashes in right display.
6. Press Freezer Up Keypad and Freezer Down Keypad to toggle through Service Test numbers.
7. Exit the test mode by closing the refrigerator door, or leave the unit unattended for 4 minutes and it will exit the test mode automatically.

SERVICE TEST – 101 DEFROST HEATER & DEFROST CIRCUIT

- Press the Refrigerator Up Keypad and Refrigerator Down Keypad to energize or de-energize the Defrost circuit. The display will read OFF when de-energized, OP when energized with open defrost thermostat, and CL when energized with closed defrost thermostat.

SERVICE TEST – 102 COMPRESSOR / CONDENSER FAN

- Press the Refrigerator Up Keypad and Refrigerator Down Keypad to toggle Compressor/Condenser fan On and Off.

SERVICE TEST – 111 FRESH FOOD FAN (IF EQUIPPED)

- Press the Refrigerator Up Keypad and Refrigerator Down Keypad to toggle Fresh Food Fan On and Off.

NOTE: Display will show state OFF or DC voltage.

SERVICE TEST – 112 FREEZER FAN

- Press the Refrigerator Up Keypad and Refrigerator Down Keypad to toggle Freezer Fan On and Off.

NOTE: Display will show state OFF or DC voltage.

SERVICE TEST – 121 DAMPER OPERATION

- Press the Refrigerator Up Keypad and Refrigerator Down Keypad to toggle Damper (OP) open and (CL) closed.

NOTE: If damper is opening or closing it will not allow you to toggle damper and beep. Display will show state –CL, or –OP if damper is in the process of closing or opening.

SERVICE TEST – 131 (3) DOOR BOTTOM FREEZER MULLION HEATER (IF EQUIPPED)

- Press the Refrigerator Up Keypad and Refrigerator Down Keypad to toggle Mullion Heater Off and On.

SERVICE TEST – 141 FRESH FOOD THERMISTOR

- Will show Fresh Food Temperature or OP for open thermistor or SH for shorted thermistor.

SERVICE TEST – 142 FREEZER THERMISTOR

- Will show Freezer Temperature or OP for open thermistor or SH for shorted thermistor.

SERVICE TEST – 143 MACHINE COMPARTMENT THERMISTOR

- Will show Machine Compartment Temperature or OP for open thermistor or SH for shorted thermistor.

SERVICE TEST – 151 FRESH FOOD DOOR STATE

- Will show state of Fresh Food Door. OP (open) CL (closed).

NOTE: By pushing fresh food door switch you can toggle state from OP (open) to CL (closed).

SERVICE TEST – 152 FREEZER FOOD DOOR STATE

- Will show state of Freezer Door. OP (open) CL (closed).

NOTE: By pushing freezer door switch you can toggle state from OP (open) to CL (closed).

SERVICE TEST – 161 CUBE DISPENSER (IF EQUIPPED)

- Display shows the state of the Cube Dispenser (ON or OFF).

NOTE: By pushing Actuator pad you can control state of Cube Dispenser without opening Ice Chute door.

SERVICE TEST – 162 CRUSHER DISPENSER (IF EQUIPPED)

- Display shows the state of the Crusher Dispenser (ON or OFF).

NOTE: By pushing Actuator pad you can control state of Crusher Dispenser without opening Ice Chute door.

SERVICE TEST – 163 WATER DISPENSER (IF EQUIPPED)

- Display shows the state of the Water Dispenser (ON or OFF).

NOTE: By pushing Actuator pad or Bottle fill you can control state of Water Dispenser.

SERVICE TEST – 164 ICE CHUTE DISPENSER (IF EQUIPPED)

- Display shows the state of the Ice Chute Dispenser. OP (open) or CL (closed).

NOTE: By pushing Actuator pad you can control state of Ice Chute Dispenser.

SERVICE TEST – 165 DISPENSER LAMP (IF EQUIPPED)

- Display shows the state of the Dispenser Lamp (ON or OFF).

NOTE: By pushing Actuator pad or Bottle fill you can control state of Dispenser Lamp.

SERVICE TEST – 171 ACTUATOR PAD (IF EQUIPPED)

- Display shows the state of the Actuator Pad (ON or OFF).

SERVICE TEST – 172 SPORTS FILL (IF EQUIPPED)

- Display shows the state of the Sports Fill (ON or OFF).

SERVICE TEST – 173 AMBIENT LIGHT (IF EQUIPPED)

- Display shows light sensor measurement (Hi or Lo). Night light will turn on light sensor measures Lo. By changing the sensor's exposure to ambient light you can control the sensor measurement.

SERVICE TEST – 174 WATER ACTUATOR BOTTOM MOUNT INTERNAL DISPENSER (IF EQUIPPED)

- Display shows the state of the Water Valve (ON or OFF).

NOTE: By pushing Water Actuator you can control state of Water Valve On or Off.

SERVICE TEST – 175 DISPENSER LINE (IF EQUIPPED)

- Display shows the state of the Dispenser Line (ON or OFF).

NOTE: By pushing Actuator pad or Bottle fill you can change state of Dispenser Line.

SERVICE TEST – 181 KEYPAD OPERATION

- Display shows a numeric or letter display indicating the last key pressed.

NOTE: Refrigerator Up/Down keypads have no effect when pressed and Freezer Up/Down keypads remain operational.

SERVICE TEST – 182 LED INDICATOR OPERATION

- Press the Refrigerator Up Keypad to show operation of LED Indicators. All LED Indicators will flash. Press again and the LED will stop flashing.

SERVICE TEST – 191 ICE MAKER WATER VALVE

- Display shows the state of the Ice Maker Water Valve (ON or OFF).

SERVICE TEST – 201 MULLION HEATER OVERRIDE (IF EQUIPPED)

- Press the Refrigerator Up Keypad or Refrigerator Down Keypad to change Mullion Heater from cycling on with compressor (Off position) to 100% operation (On Position).

SERVICE TEST – 202 DEFAULT DEFROST OPERATION

- Press the Refrigerator Up Keypad or Refrigerator Down Keypad to change Defrost Operation from normal adaptive defrost (Off position) to minimum time between defrosts (On position).

SERVICE TEST – 203 SHOW TEMPERATURE SETPOINTS

- Press the Refrigerator Up Keypad or Refrigerator Down Keypad to change from showing actual temperature (Off position) showing temperature setpoints only (On position).

SERVICE TEST – 211 FRESH FOOD TEMPERATURE ADJUSTMENT

- Press the Refrigerator Up Keypad or Refrigerator Down Keypad to change calibration of Fresh Food Temperature plus or minus in 1°F increments up to ± 6°F.

NOTE: Temperature will read in Fahrenheit regardless of what current temperature scale is being used.

SERVICE TEST – 212 FREEZER TEMPERATURE ADJUSTMENT

- Press the Refrigerator Up Keypad or Refrigerator Down Keypad to change calibration of Freezer Temperature plus or minus in 1°F increments up to ± 6°F.

NOTE: Temperature will read in Fahrenheit regardless of what current temperature scale is being used.

SERVICE TEST – 221 RESET DEFAULT SETTINGS

- Press the Refrigerator Up Keypad and Refrigerator Down Keypad to force to dEF (default factory settings).
- Exit the test mode by closing both refrigerator doors.

TROUBLESHOOTING

Symptom	Possible Causes	Corrective Action
Unit does not run	No power to unit	Check for power at outlet. Check fuse box/circuit breaker for blown fuse or tripped breaker. Replace or reset.
	Faulty power cord	Check with test light at unit; if no circuit and current is indicated at outlet, replace or repair.
	Low voltage	Check input voltage for proper voltage. Take appropriate action to correct voltage supply problem.
	Faulty motor or freezer temperature control	Check all connections are tight and secure. Jumper across terminals of control. If unit runs, replace control.
	Faulty timer	Check with test light. Replace if necessary.
	Faulty relay	Check relay. Replace if necessary.
	Faulty compressor	Check compressor motor windings for opens/shorts. Perform compressor direct wiring test. Replace if necessary.
	Faulty overload	Check overload for continuity. NOTE: Ensure compressor/overload are below trip temperature before testing. Replace if necessary.
Refrigerator section too warm	Excessive door opening	Consumer education
	Overloading of shelves	Consumer education
	Warm or hot foods placed in cabinet	Consumer education
	Cold control set too warm	Set control to colder setting.
	Poor door seal	Level cabinet. Adjust hinges. Replace gasket.
	Refrigerator airflow	Check damper is opening by removing grille. With door open, damper should open. Replace if faulty. Turn control knob to colder position.
	Interior light remains on	Check switch. Replace if necessary.
	Faulty condenser fan or evaporator fan	Check fan and wiring. Replace if necessary.
	Faulty compressor	Replace compressor.

Symptom	Possible Causes	Corrective Action
Refrigerator section too cold	Refrigerator temperature control set too cold	Adjust refrigerator temperature control.
	Refrigerator airflow not properly adjusted	Check air flow.
Freezer and refrigerator sections too warm	Temperature controls set too warm	Reset temperature controls.
	Poor door seal	Level cabinet. Adjust hinges. Replace gasket.
	Dirty condenser or obstructed grille	Check condenser and grille. Clean.
	Faulty control	Test control. Replace if failed.
	Refrigerant shortage or restriction	Check for leak or restriction. Repair, evacuate and recharge system.
Freezer section too cold	Freezer temp control set too cold	Adjust freezer temperature control.
	Faulty control	Test control. Replace if failed.
	Cold control capillary not properly clamped to evaporator	Reposition clamp and tighten.
Unit runs continuously	Temperature control set too cold	Adjust temperature control.
	Dirty condenser or obstructed grille	Check condenser and grille. Clean.
	Poor door seal	Level cabinet. Adjust hinges. Replace gasket.
	Interior light remains on	Check switch. Replace if necessary.
	Faulty condenser fan or evaporator fan	Check fan and wiring. Replace if necessary.
	Faulty control	Test control. Replace if failed.
	Refrigerant shortage or restriction	Check for leak or restriction. Repair, evacuate and recharge system.
	Refrigerant overcharge	Check for overcharge. Evacuate and recharge system.
Unit runs continuously. Temperature normal.	Air in system	Check for low side leak. Repair, evacuate and recharge system.
Unit runs continuously. Temperature too cold.	Ice on evaporator	See "Frost or Ice on evaporator".
Unit runs continuously. Temperature too cold.	Faulty defrost thermostat	Check thermostat. Replace if necessary.
Noisy operation	Loose flooring or floor not firm	Repair floor or brace floor.
	Cabinet not level	Level cabinet.
	Tubing in contact with cabinet, other tubing, or other metal	Adjust tubing.
	Drip pan vibrating	Adjust drain pan.
	Fan hitting another part	Ensure fan properly aligned and all attaching hardware and brackets are tight and not worn. Tighten or replace.
	Worn fan motor bearings	Check motor for loss of lubricant or worn bearings. Replace if necessary.
	Compressor mounting grommets worn or missing. Mounting hardware loose or missing	Tighten hardware. Replace grommets if necessary.
	Free or loose parts causing or allowing noise during operation	Inspect unit for parts that may have worked free or loose or missing screws. Repair as required.

Symptom	Possible Causes	Corrective Action
Frost or ice on evaporator	Defrost thermostat faulty	Check defrost thermostat. Replace if failed.
	Evaporator fan faulty	Check fan motor. Replace if failed.
	Defrost heater remains open	Check defrost heater continuity. Replace if failed.
	Defrost control faulty	Check control and replace if failed.
	Open wire or connector	Check wiring and connections. Repair as necessary.
	Refrigerant shortage or restriction	Check for leak or restriction. Repair, evacuate and recharge system.
Unit starts and stops frequently (cycles on and off)	Loose wire or thermostat connections	Check wiring and connections. Repair as necessary.
	Supply voltage out of specification	Check input voltage. Correct any supply problems.
	Overload protector open	Check overload protector for continuity. If open, replace overload. NOTE: Ensure overload/compressor are below trip temperature before testing.
	Faulty compressor motor capacitor (some compressors do not require motor capacitor)	Check capacitor for open/short. Replace if necessary. NOTE: Discharge capacitor before testing.
	Faulty fan motor	Check fan motor. Replace if failed.
	Restricted air flow	Check condenser and grille for dirt. Clean.
	Refrigerant shortage or restriction	Check for leak or restriction. Repair, evacuate and recharge system.

WIRING DIAGRAMS

WIRING DIAGRAM 1

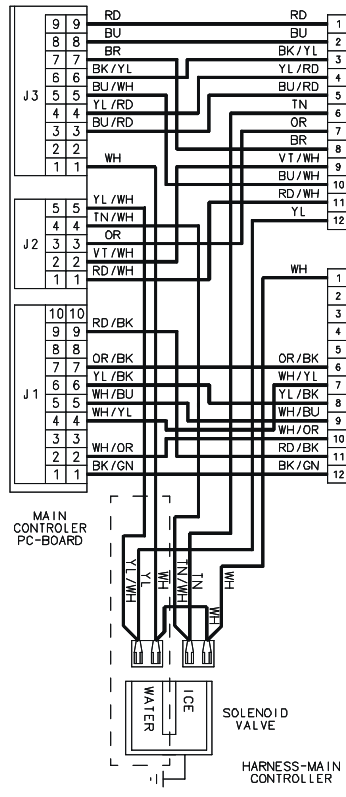
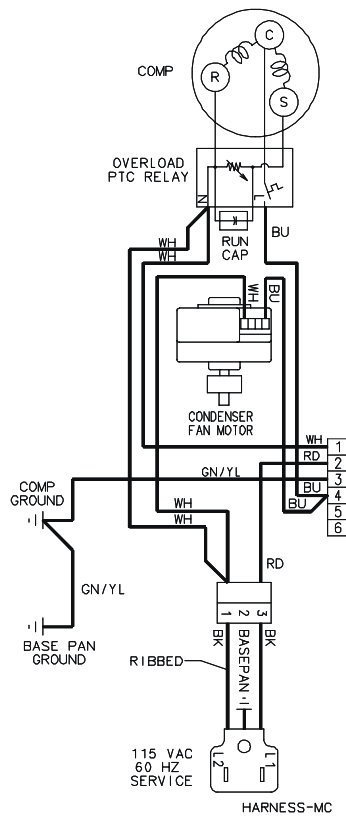

WIRING DIAGRAM 2

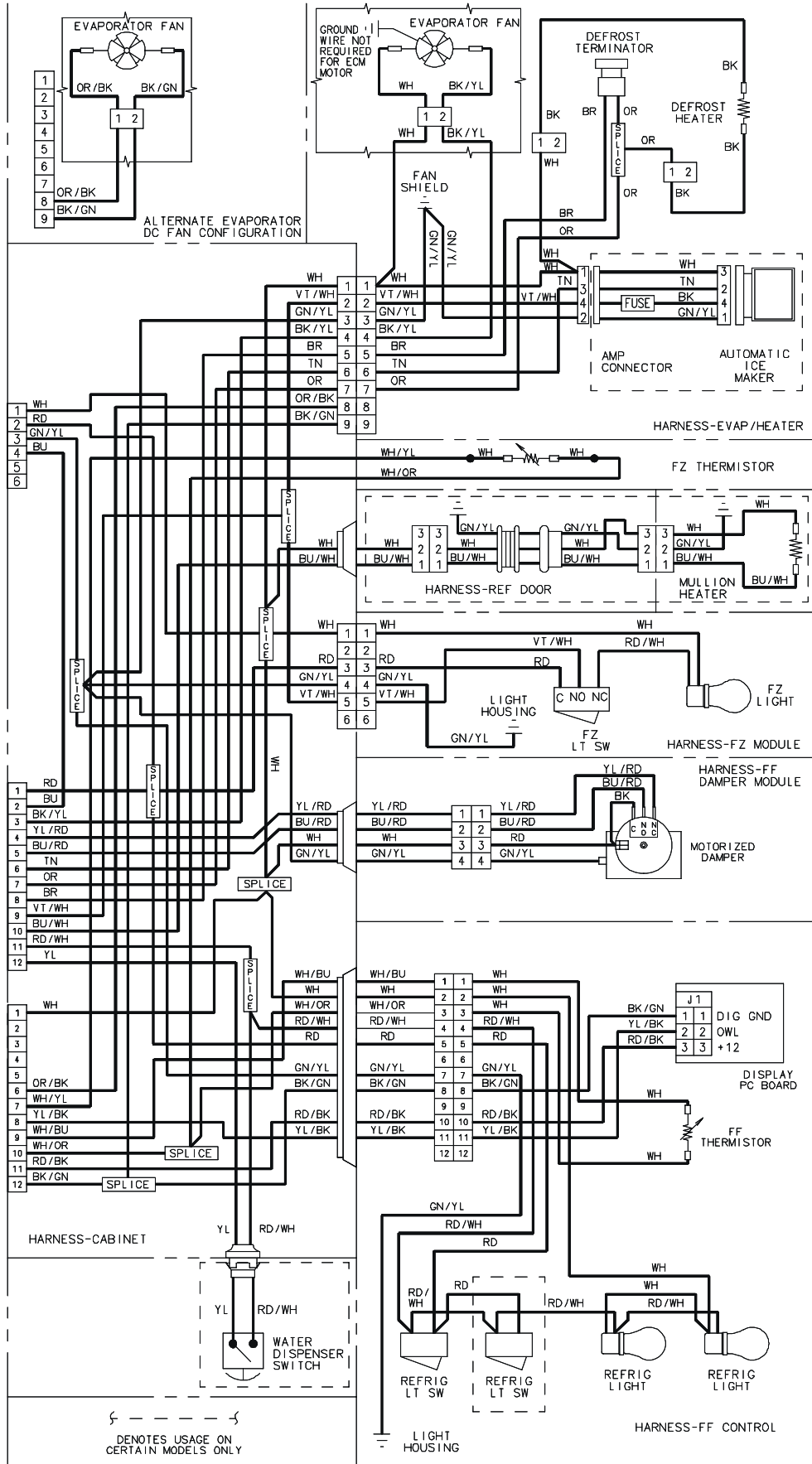

SCHEMATIC DIAGRAM

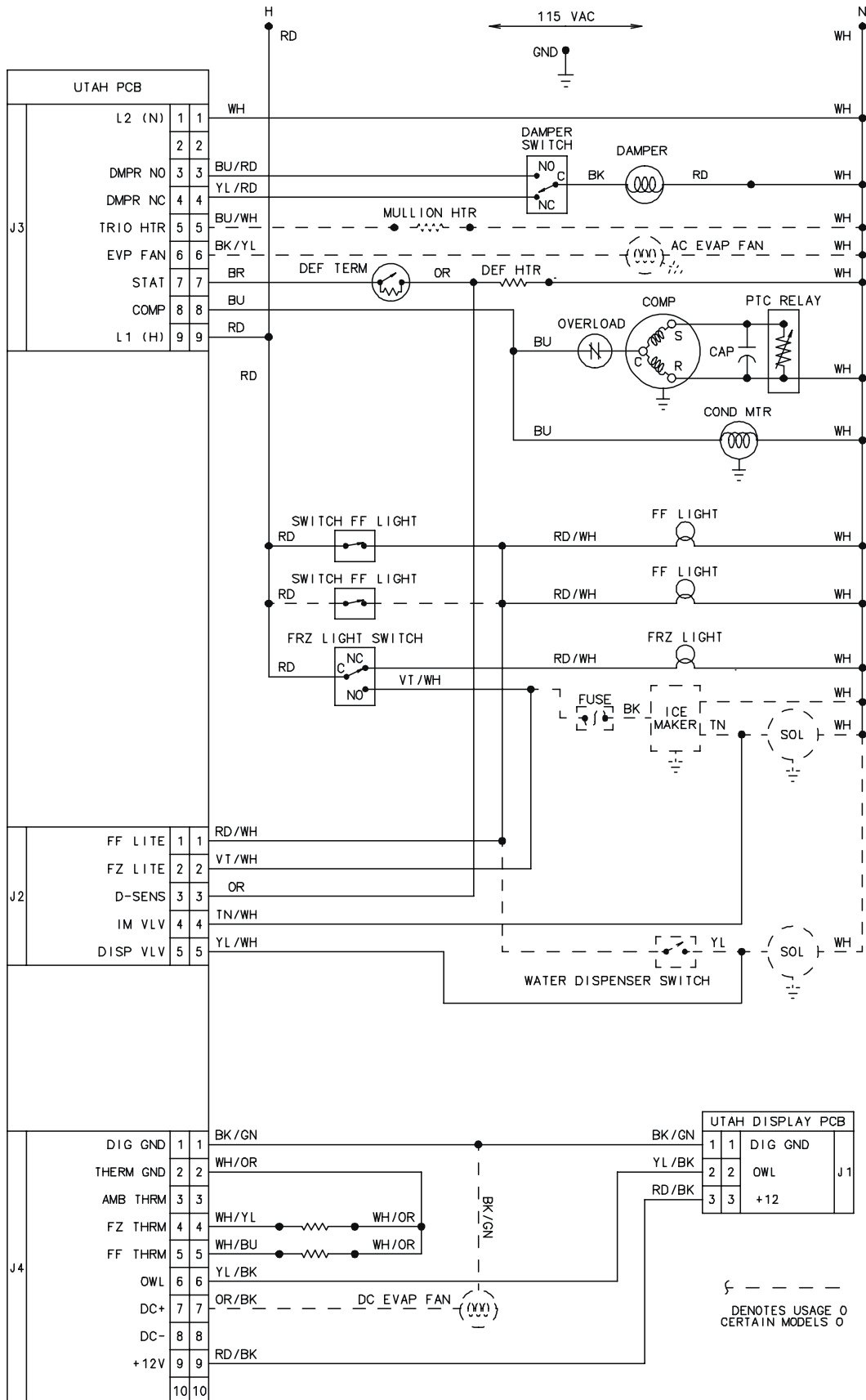

— NOTES —

— NOTES —

— NOTES —

PRODUCT SPECIFICATIONS AND WARRANTY INFORMATION SOURCES

IN THE UNITED STATES:

FOR PRODUCT SPECIFICATIONS AND WARRANTY INFORMATION CALL:

FOR WHIRLPOOL PRODUCTS: 1-800-253-1301

FOR KITCHENAID PRODUCTS: 1-800-422-1230

FOR ROPER PRODUCTS: 1-800-447-6737

FOR TECHNICAL ASSISTANCE WHILE AT THE CUSTOMER'S HOME CALL:

THE TECHNICAL ASSISTANCE LINE: 1-800-253-2870

**HAVE YOUR STORE NUMBER READY TO IDENTIFY YOU AS AN
AUTHORIZED SERVICER**

FOR LITERATURE ORDERS:

PHONE: 1-800-851-4605

FOR TECHNICAL INFORMATION AND SERVICE POINTERS:

www.servicematters.com

IN CANADA:

FOR PRODUCT SPECIFICATIONS AND WARRANTY INFORMATION CALL:

1-800-461-5681

FOR TECHNICAL ASSISTANCE WHILE AT THE CUSTOMER'S HOME CALL:

THE TECHNICAL ASSISTANCE LINE: 1-800-488-4791

**HAVE YOUR STORE NUMBER READY TO IDENTIFY YOU AS AN
AUTHORIZED SERVICER**

KitchenAid[®]
FOR THE WAY IT'S MADE.[®]