

TECHNICAL EDUCATION

**2008 DOUBLE DRAWER
UNDER COUNTER
REFRIGERATOR / FREEZER
PRODUCTS**



KDDC24RVS
KDDO24RVX
KDDC24CVS
KDDO24CVX
KDDC24FVS
KDDO24FVX

JUD248RCRS
JUD248RCCX
JUD248CCRS
JUD248CCCR
JUD248FCRS
JUD248FCCX

FORWARD

This Job Aid “2008 Double Drawer Under Counter Refrigerator / Freezer Products” (Part No. 4317434), provides the In-Home Service Professional with information on the installation, operation, and service of the 2008 Double Drawer Refrigerator / Freezer. For specific information on the model being serviced, refer to the “Use and Care Guide,” or “Tech Sheet” provided with the refrigerator / freezer.

The Wiring Diagrams used in this Job Aid are typical and should be used for training purposes only. Always use the Wiring Diagram supplied with the product when servicing the refrigerator / freezer.

GOALS AND OBJECTIVES

The goal of this Job Aid is to provide detailed information that will enable the In-Home Service Professional to properly diagnose malfunctions and repair the 2008 Double Drawer Refrigerator / Freezer.

The objectives of this Job Aid are to:

- Successfully troubleshoot and diagnose malfunctions.
- Successfully perform necessary repairs.
- Successfully return the refrigerator / freezer to its proper operational status.

WHIRLPOOL CORPORATION assumes no responsibility for any repairs made on our products by anyone other than In-Home Service Professionals.

TABLE OF CONTENTS

	Page(s)
GENERAL	1-1
Refrigerator / Freezer Safety.....	1-1
Design Specifications.....	1-2 , 1-3
Model And Serial Number Label Location.....	1-4
INSTALLATION INFORMATION	2-1
Electrical Supply Requirements	2-1
Location Requirements	2-2
Water Supply Requirments	2-3
Product Dimensions.....	2-4
THEORY OF OPERATION	3-1
Operating Systems.....	3-1 , 3-2
Refrigerator/Freezer Combo Cooling Operation	3-3
Refrigerator/Freezer Combo Defrost Operation.....	3-4
COMPONENT ACCESS	4-1
Drawer Removal	4-1
Drawer Installation	4-2
Removing The Drawer Front.....	4-3
Removing The User Interface Board.....	4-4
Installing The User Interface Board.....	4-5
Component Locations	4-6
Icemaker	4-7
Removing The Separator	4-8 , 4-9 , 4-10
Evaporator Components	4-11
Machine Compartment Components	4-12 , 4-13
Removing The Water Valve.....	4-14
Condenser And PC Board.....	4-15
DIAGNOSTICS AND TROUBLESHOOTING	5-1
Main PCB Connector Function.....	5-1 , 5-2 , 5-3
Display PCB Connector Function.....	5-3
Built-In Board Diagnostics.....	5-4
WIRING DIAGRAMS	6-1 , 6-2
Product Specifications and Warranty Information Sources.....	6-3

NOTES

GENERAL

REFRIGERATOR / FREEZER SAFETY

Your safety and the safety of others are very important.

We have provided many important safety messages in this manual and on the appliance. Always read and obey all safety messages.



This is the safety alert symbol.

This symbol alerts you to potential hazards that can kill or hurt you and others.

All safety messages will follow the safety alert symbol and either the word “DANGER” or “WARNING.” These words mean:

! WARNING

You can be killed or seriously injured if you don't immediately follow instructions.

! DANGER

You can be killed or seriously injured if you don't follow instructions.

All safety messages will tell you what the potential hazard is, tell you how to reduce the chance of injury, and tell you what can happen if the instructions are not followed.

DESIGN SPECIFICATIONS

24" Drawer Models

Double Refrigerator Drawers

Two refrigerator drawers provide additional storage options in the kitchen or other areas of the home.

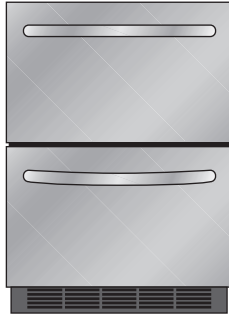

Euro Series
JUD248RCRS

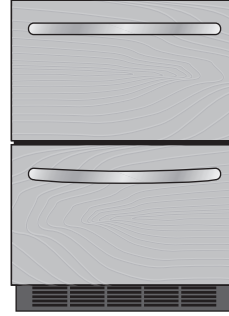

Overlay - Custom Panels and Handles Required
JUD248RCCX

Refrigerator/Freezer Drawers (with ice maker and water filter)

Upper refrigerator drawer and lower freezer drawer provide additional storage options in the kitchen or other areas of the home. Factory-installed ice maker in lower drawer ensures a constant supply of ice on hand at all times.



Euro Series
JUD248CCRS

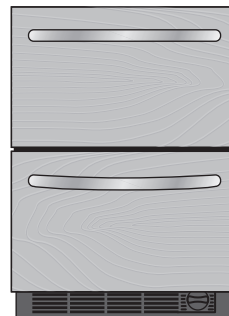

Overlay - Custom Panels and Handles Required
JUD248CCCX

Double Freezer Drawers (with ice maker and water filter)

Two freezer drawers provide additional storage options in the kitchen or other areas of the home. Factory-installed ice maker in lower drawer ensures a constant supply of ice on hand at all times.

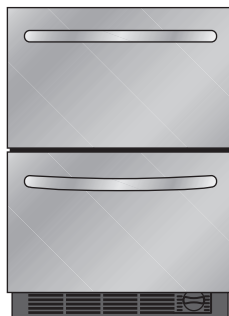

Euro Series
JUD248FCRS

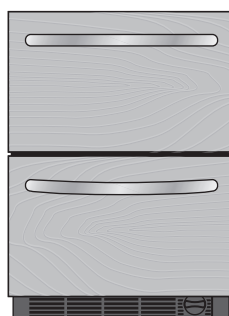

Overlay - Custom Panels and Handles Required
JUD248FCCX

DESIGN SPECIFICATIONS (continued)

24" Drawer Models

Double Refrigerator Drawers

Two refrigerator drawers provide additional storage options in the kitchen or other areas of the home.

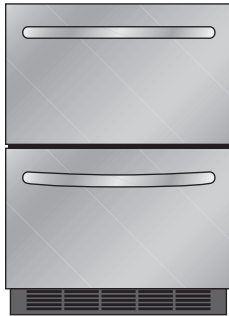

Architect[®] Series II
KDDC24RVS



Overlay - Custom Panels and Handles Required
KDDO24RVX

Refrigerator/Freezer Drawers (with ice maker and water filter)

Upper refrigerator drawer and lower freezer drawer provide additional storage options in the kitchen or other areas of the home. Factory-installed ice maker in lower drawer ensures a constant supply of ice on hand at all times.

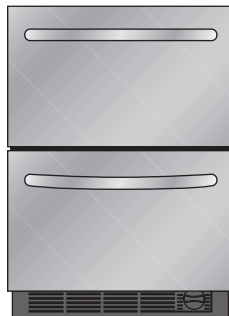

Architect[®] Series II
KDDC24CVS

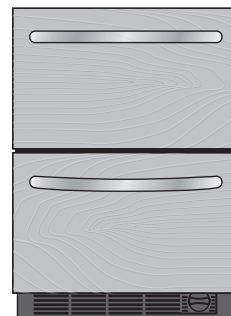

Overlay - Custom Panels and Handles Required
KDDO24CVX

Double Freezer Drawers (with ice maker and water filter)

Two freezer drawers provide additional storage options in the kitchen or other areas of the home. Factory-installed ice maker in lower drawer ensures a constant supply of ice on hand at all times.

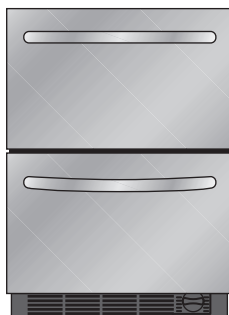

Architect[®] Series II
KDDC24FVS

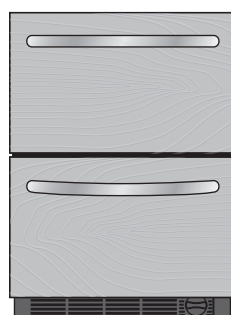

Overlay - Custom Panels and Handles Required
KDDO24FVX

MODEL AND SERIAL NUMBER LABEL LOCATION

The Model/Serial Number label location is shown below.

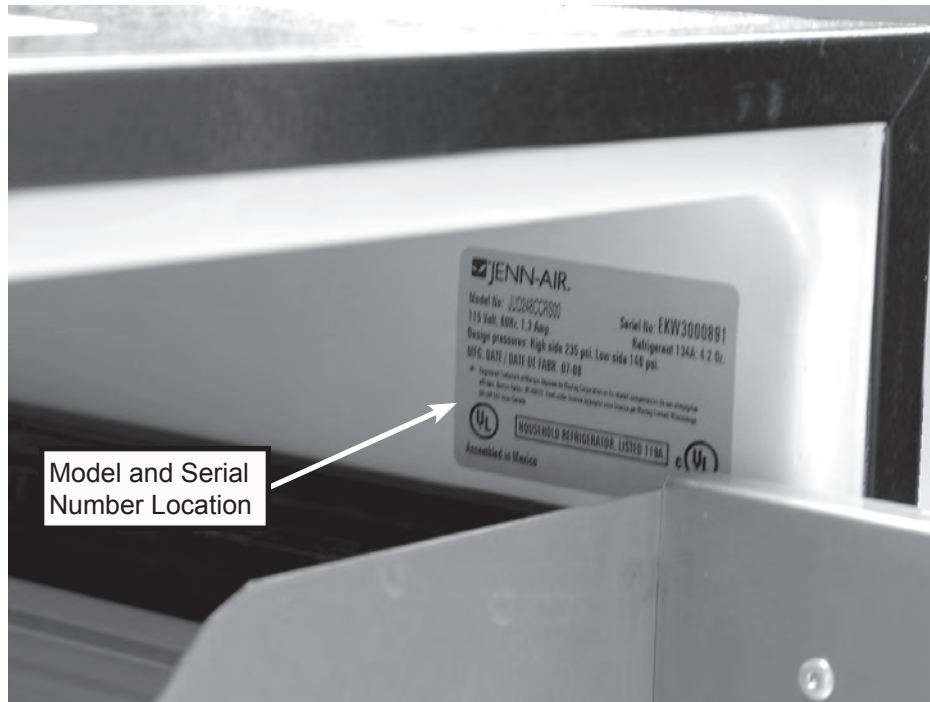

After pulling the upper drawer out, the Model/Serial Number label is on the inside upper right corner.

INSTALLATION INFORMATION

ELECTRICAL SUPPLY REQUIREMENTS

WARNING



Electrical Shock Hazard

**Plug into a grounded 3 prong outlet.
Do not remove ground prong.
Do not use an adapter.
Do not use an extension cord.
Failure to follow these instructions can
result in death, fire, or electrical shock.**

WARNING

Excessive Weight Hazard

**Use two or more people to move and
install refrigerator.
Failure to do so can result in back or
other injury.**

Recommended Grounding Method

This appliance must be grounded. This appliance is equipped with a power supply cord having a 3-prong grounding plug. The cord must be plugged into a mating, 3-prong, grounding-type wall receptacle, grounded in accordance with the National Electrical Code and local codes and ordinances. If a mating wall receptacle is not available, it is the personal responsibility of the customer to have a properly grounded, 3-prong wall receptacle installed by a qualified electrician.

Before you move the refrigerator into its final location, it is important to make sure you have the proper electrical connection:

- A 115 Volt, 60 Hz, AC only 15- or 20-amp electrical supply, properly grounded in accordance with the National Electrical Code and local codes and ordinances, is required.
- It is recommended that a separate circuit, serving only this appliance, be provided. Use a receptacle which cannot be turned off by a switch or pull chain.

LOCATION REQUIREMENTS

⚠ WARNING



Keep flammable materials and vapors, such as gasoline, away from refrigerator drawer(s). Failure to do so can result in death, explosion, or fire.

NOTES:

- For the refrigerator drawers to be flush with the front of the base cabinets remove any baseboards or moldings from the rear of the opening. See “Product Dimensions” and later in this section “Opening Dimensions (both styles).”
- It is recommended that you do not install the refrigerator drawers near an oven, radiator, or other heat source.
- Do not install in a location where the temperature will fall below 55°F (13°C).

OPENING DIMENSIONS (BOTH STYLES)

- Height dimensions are shown with the leveling legs extended to the minimum height of 1/4" (6.35 mm) below the refrigerator drawers.

NOTE: When leveling legs are fully extended to 1" (25 mm) below the refrigerator drawers, add 3/4" (19.05 mm) to the height dimensions.
See “Product Dimensions.”

- If the floor of the opening is not level with the kitchen floor,
- shim the opening to make it level with the kitchen floor.

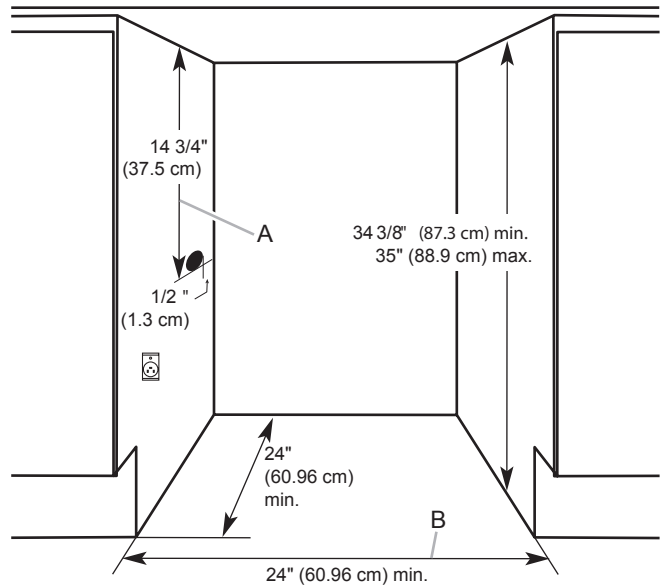

Critical Dimensions:

- A. 14 3/4" (37.5 cm) utility opening
- B. 24" (60.96 cm) minimum opening width

WATER SUPPLY REQUIREMENTS

Gather the required tools and parts before starting installation.
Read and follow the instructions provided with any tools listed here.

TOOLS NEEDED:

- Flat-blade screwdriver
- 7/16" open-end wrench
- 1/2" open-end wrench or two adjustable wrenches
- 1/4" nut driver and drill bit
- Cordless drill and drill bit

NOTE: Your refrigerator dealer has a kit available with a 1/4" (6.35 mm) saddle-type shutoff valve, a union, and copper tubing. Before purchasing, make sure a saddle-type valve complies with your local plumbing codes. Do not use a piercing-type or 3/8" (4.76 mm) saddle valve which reduces water flow and clogs more easily.

IMPORTANT:

- If you turn the refrigerator on before the water line is connected, turn the ice maker OFF.
- All installations must meet local plumbing code requirements.
- Use copper tubing and check to make sure there are no leaks. Install copper tubing only in areas where the household temperatures will remain above freezing.

WATER PRESSURE

A cold water supply with water pressure of between 30 and 120 psi (207 and 827 kPa) is required to operate ice maker. If you have questions about your water pressure, call a licensed, qualified plumber.

Reverse Osmosis Water Supply

IMPORTANT:

The pressure of the water supply coming out of a reverse osmosis system going to the water inlet valve of the refrigerator needs to be between 30 and 120 psi (207 and 827 kPa).

If a reverse osmosis water filtration system is connected to your cold water supply, the water pressure to the reverse osmosis system needs to be a minimum of 40 to 60 psi (276 to 414 kPa). If the water pressure to the reverse osmosis system is less than 40 to 60 psi (276 to 414 kPa):

- Check to be sure the sediment filter in the reverse osmosis system is not blocked. Replace filter if necessary.
- Allow the storage tank on the reverse osmosis system to refill after heavy usage.

If you have questions about your water pressure, call a licensed, qualified plumber.

PRODUCT DIMENSIONS

STYLES 1 AND 2: ARCHITECT® SERIES AND OVERLAY

- Height dimensions are shown with the leveling legs extended to 1/4" (6.35 mm) below the refrigerator drawers.
- When leveling legs are fully extended to 1" (25 mm) below the refrigerator drawers, add 3/4" (19.05 mm) to the height dimensions.
- The power cord is 60" (152.4 cm) long

Style 1: Architect® Series

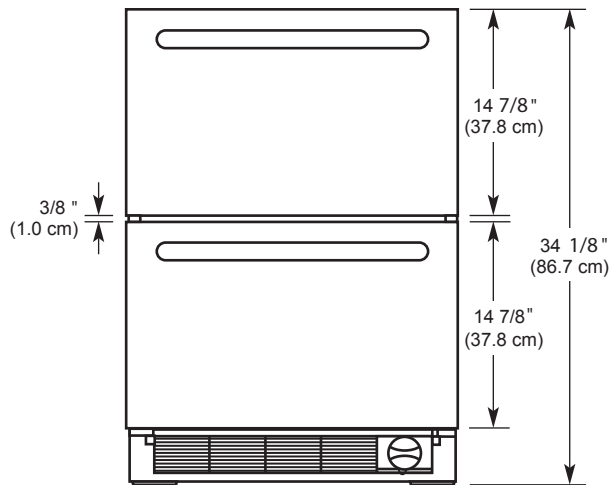

Style 2: Overlay

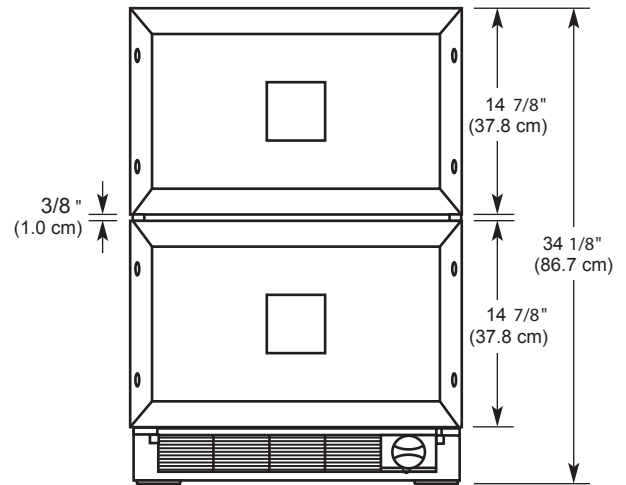

THEORY OF OPERATION

OPERATING SYSTEMS

1) General Cooling Operation of the RR (All Refrigerator) and FF (All Freezer)

There is an upper chamber and lower chamber with each chamber having a dedicated drawer. Even though two chambers are not physically separated, there is one dedicated thermistor for each chamber (total of two per unit) that is located in front of the fan cover. Each chamber has a dedicated DC evaporator motor (a total of two) that is mounted in front of the fan cover.

A thermistor is used to measure the temperature of each chamber at real sampling time. This measured temperature is used to control the operation of the compressor, DC condenser fan motor and DC evaporator fan motors as well as to display the chamber temperature. The displayed temperature, however; is not the real time temperature; it is a computed weighted average temperature to minimize the possible confusion of average end users.

As the usual start up, the main PCB turns on the condenser fan and after 10 seconds the compressor will start. The compressor will continue to run until the temperatures of both thermistors reach the set temperature -4°F (the number 4 is subject to design change). While the compressor is on, the main PCB turns only one of two evaporator fans on. The evaporator fan in the upper chamber acts as a primary source of air movement of the both chambers. When the upper thermistor reaches the set temperature of -4°F , the upper evaporator fan motor stops, and logic reads the lower thermistor temperature. If it is higher than the set temperature of -4°F , the main PCB will turn on the lower evaporator fan and continue to run the compressor.

Normally, this switching between upper and lower evaporator fans repeats several times before both temperatures reach below the set temperature of -4°F . Once the temperatures of both thermistors reach below the set temperature of -4°F , the main PCB shuts off the compressor and both evaporator fans. Main PCB will turn off the condenser fan 2 minutes later.

The condenser fan and the compressor will be turned on again when one of the thermistor temperatures reaches the set temperature 4°F . In this event the process listed at the beginning of this section will repeat before shutting off the compressor again.

2) General Cooling Operation of the RF (Combination Unit)

The upper chamber and lower chamber are physically divided by the center mullion with each chamber having a dedicated drawer. As the two chambers are physically and thermally separated, there is one dedicated thermistor for each chamber (total of two) located in front of fan cover. Each chamber has a dedicated DC evaporator motor (a total of two). These DC evaporator fan motors are also mounted in front of the fan cover.

The thermistor is used to measure the temperature of each chamber at real sampling time. This measured temperature is used to control the operation of compressor, DC condenser fan motor and DC evaporator fan motors as well as to display two chamber temperatures. The displayed temperature, however; is not the real time temperature; it is a computed weighted average temperature to minimize the possible confusion of average end users.

Continued on next page

OPERATING SYSTEMS (continued)

As the usual start up, the main PCB turns on the condenser fan and after 10 seconds the compressor will start. The compressor will continue to run until the temperatures of both thermistors reach the set temperature for each chamber of -4°F (the number 4 is subject to design change). While the compressor is on, the main PCB turns only one of the two evaporator fans on. The evaporator fan in the lower chamber is turned on primarily, as the lower chamber is a freezer (about 0°F) and the upper chamber is a refrigerator (4°F). When the lower thermistor temperature reaches to the freezer set temperature of -4°F , the lower evaporator fan motor stops, and logic reads the upper thermistor temperature. If it is higher than the refrigerator set temperature of -4°F the main PCB will turn on the upper evaporator fan and continue to run the compressor. Normally, this switching between upper and lower evaporator fans repeats several times before both temperatures reach below the set temperature of -4°F . Once the temperatures of both thermistors reach below the set temperature of -4°F , the main PCB shuts off the compressor and both evaporator fans. Main PCB will turn off the condenser fan 2 minutes later.

When the temperature of the thermistor of upper chamber (refrigerator) reaches the refrigerator set temperature of 4°F , but the freezer thermistor temperature remains below the freezer set temperature 4°F , the main PCB will turn on the upper evaporator fan without turning the condenser fan or the compressor. Basically, cooling logic is using the cold air of the freezer section to cool the refrigerator section during this period. If the thermistor temperature of the upper chamber (refrigerator) reaches the refrigerator set temperature -4°F while the thermistor temperature of the lower chamber (freezer) is still lower than the freezer set temperature 4°F (and this seems to happen regular basis), the main PCB will simply turns off the upper evaporator fan without ever turning the compressor on.

If the thermistor temperature of the lower chamber (freezer) reaches to the freezer set temperature of 4°F , the main PCB will turn on the condenser fan, then the compressor and the lower evaporator fan (10 seconds later) regardless to the temperature of the thermistor in the upper chamber. While the compressor is on, the above switching between two evaporator fans takes place again.

In a rare case (for example, at the beginning of ice making or the ambient temperature is very high) when the compressor is on and the temperature of the lower thermistor is kept above the freezer set temperature -4°F for extended period due to higher than normal demand in the freezer section, the main logic monitors the temperature of the upper chamber every 10 minutes or so to make sure the refrigerator temperature is within the range. If not, shut off the lower evaporator fan and turn on the upper evaporator fan until the temperature of the upper thermistor drops to the refrigerator set temperature -4°F . Once the upper thermistor temperature reaches that, the lower evaporator fan will be switched on.

3) General Defrost Operation (All Models)

The main PCB has a timer to monitor the accumulated compressor operation time. When this time reaches certain hours (for example 10 hours), the main PCB will shut off the compressor the evaporator fans, reset the timer, and stop sampling the temperature. In 30 seconds, the defrost heater will turn on and the condenser fan will be turned off 2 minutes after the shut off of the compressor. The heater will be cut off when the defrost-sensing thermistor that is mounted near the top center of the evaporator pipe has reached the preset temperature (for example 8°F). (If the defrost-sensing thermistor logic fails, then the fuse will melt as any redundantly protected refrigeration system.) Five minutes after termination of the heater, the main PCB starts to sample the temperature and the same cooling function above 1) or 2) resumes.

REFRIGERATOR/FREEZER COMBO COOLING OPERATION

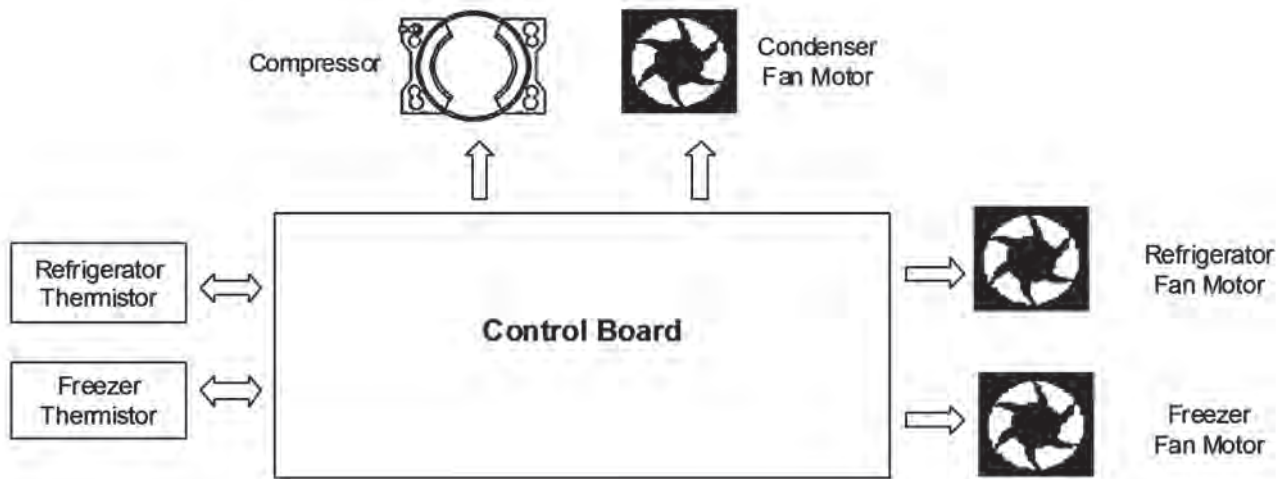

1. Power On: Compressor, condenser fan and the freezer evaporator fan turns on. The refrigerator evaporator fan remains off. The controller continues to monitor the freezer temperature sensor (bottom thermistor) until the bottom sensor temperature (BT) reaches the freezer set temperature (FST).

2. When the TT reaches $FST - 2.78^{\circ}\text{C}$, the controller stops the freezer evaporator fan and measures the refrigerator temperature - TT (top thermistor) against the refrigerator set temperature (RST). If the $TT > RST$, then the compressor and the condenser fan remain on while the top evaporator fan turns on.

3. The controller continues to monitor the TT until the $TT < RST$, then the refrigerator evaporator fan motor stops. The controller checks the BT again, if the $BT > FST$, the freezer evaporator fan turns on while the compressor and condenser fan remain on.

Repeat step 3 until both TT and BT are below the set temperatures minus differentials (i.e. $TT < RST$ and $BT < FST$). If both TT and BT are below set temperatures minus differentials, then all the motors and

compressor stop. Once the compressor is off, the controller continues to monitor the TT and BT.

The compressor fan, condenser and the related evaporator fans turns on when the TT is higher than the RST or the BT is higher than the FST.

If the $TT > RST$, but the $BT < FST$, then the controller turns on top evaporator fan only. The compressor, condenser fan and bottom evaporator fan remain off.

The controller continues to monitor the TT and BT. If the $BT > FST$, then the compressor and condenser fan turn on, while the top evaporator fan continues to run. If the $BT < FST$ and the $TT > RST$, then the freezer evaporator fan turns on (the compressor and condenser fan remain off as long as $BT < FST$).

REFRIGERATOR/FREEZER COMBO DEFROST CYCLE

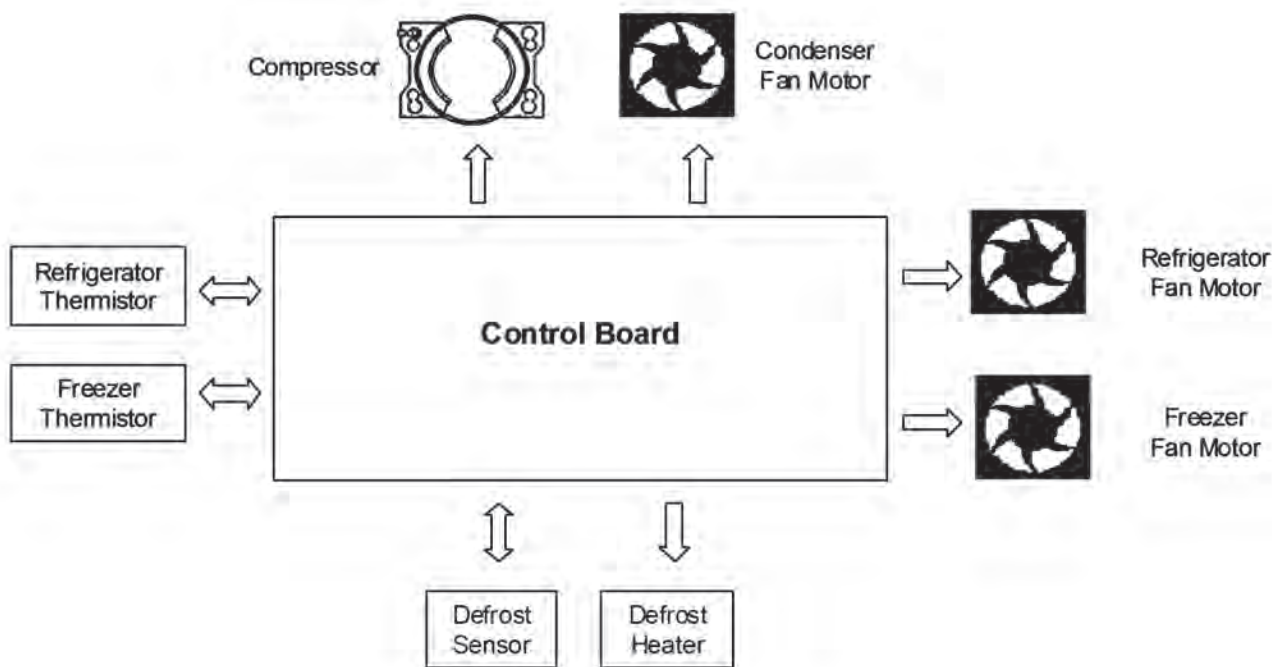

The defrost cycle starts after ten hours of compressor run time.

The condenser fan runs for two minutes after the compressor stops and the heat starts.

The evaporator fans stop immediately.

The heater is energized until the defrost sensor (top center of the evaporator) reaches 8F. (There is no set defrost time.)

A defrost thermal fuse, located in the right end of the evaporator return cuts out if an overheat condition occurs.

There is a 5-minute drip time after the defrost heat is terminated by the defrost sensor.

The condenser fan starts when the heat stops and runs throughout 5-minute drip time.

At the end of the 5-minute drip time, the compressor starts.

One minute after the compressor starts, the evaporator fans start.

Count down to the next 10 hours of compressor run time begins, and so forth.

COMPONENT ACCESS

DRAWER REMOVAL

⚠ WARNING

Electrical Shock Hazard Disconnect power before servicing. Replace all parts and panels before operating. Failure to do so can result in death or electrical shock.



Figure 1

To remove the top drawer:

1. Open the drawer.
2. Locate the wiring harness on the left side of the drawer, see figure 1.
3. Pull the harness out of the front cover to expose the connector.
4. Free the harness from the plastic retainer and disconnect the harness, see figures 2 and 3.

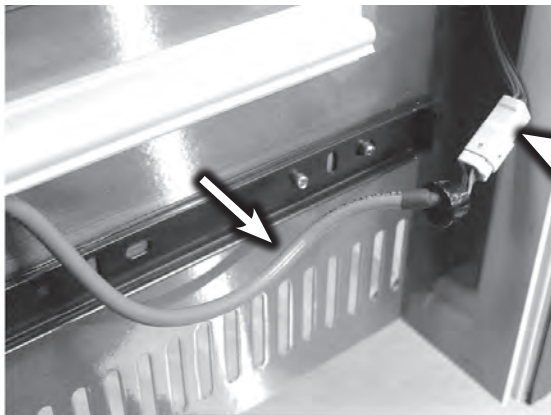

Figure 2



Figure 3



Figure 4



Figure 5

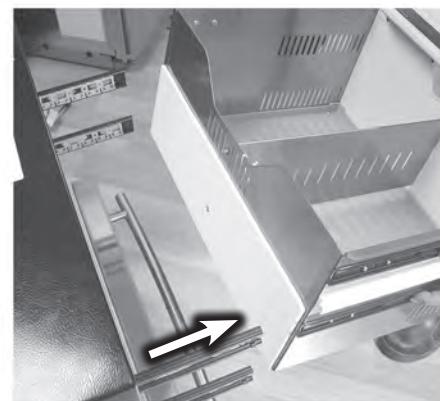

Figure 6

5. Depress the spring releases located in the left and right hand slides, see figures 4 and 5.
6. Slide drawer out and set on work surface, see figure 6.
7. Repeat the process to remove the lower drawer.

Note: The lower drawer does not have a wiring harness that must be disconnected.

DRAWER INSTALLATION

WARNING



Electrical Shock Hazard

**Disconnect power before servicing.
Replace all parts and panels before
operating.**

**Failure to do so can result in death or
electrical shock.**



Figure 1

1. Open the lower drawer.
2. Place a piece of cardboard or a blanket on the drawer to shelter it, see figure 1.



Figure 5

5. Rest the upper drawer on the lower drawer.
6. Align the lower slides to the lower rails.
7. Start the slide onto the rail, see figure 5.

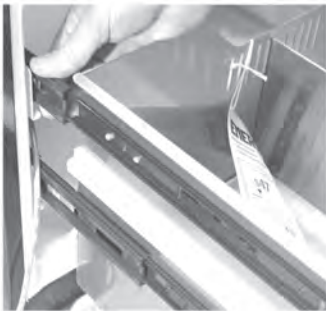

Figure 2

3. Start the upper rail into the slide.
4. Repeat the process on the opposite side, see figure 2.

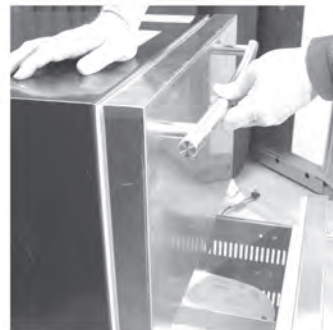

Figure 6

8. Check drawer or Proper fit and seal, see figure 6.



Figure 3



Figure 4

9. Connect the wiring harness.
10. Install the connector into the drawer front.
11. Attach the harness into the plastic retainer along the side of the drawer, see figures 3 and 4.

REMOVING DRAWER FRONT, GASKET AND DRAWER HANDLE



Figure 1

1. Remove two screws on both sides of the drawer securing the drawer cover and drawer.
2. Separate the drawer cover from the drawer, see figure 1.

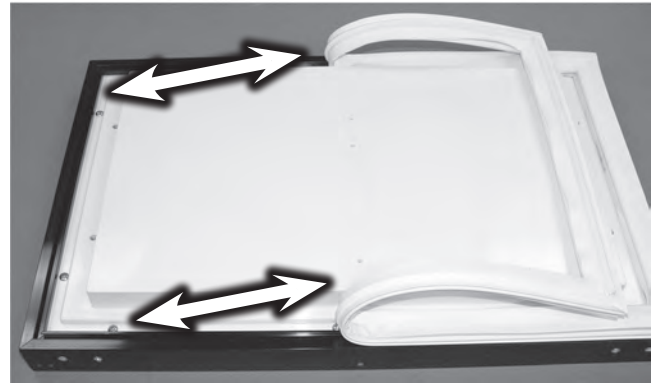

Figure 2

Gasket Removal:

The gasket pulls out of a channel in the drawer front, see figure 2.

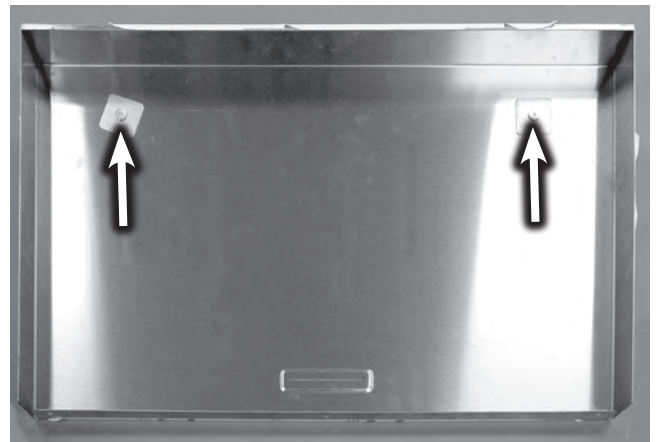

Figure 3

Handle Removal:

1. Remove the inner panel.
2. Remove the two screws securing the handle to the drawer front, see figure 3.

REMOVING THE USER INTERFACE BOARD

⚠ WARNING



Electrical Shock Hazard

Disconnect power before servicing.

Replace all parts and panels before operating.

Failure to do so can result in death or electrical shock.

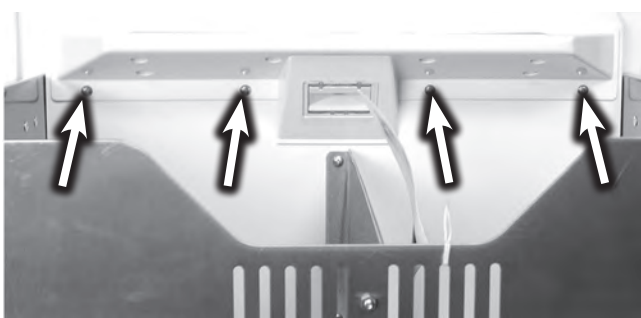

Figure 1

1. Remove the four screws securing the user interface housing to the drawer front, see figure 1.



Figure 2

2. Separate the housing from the drawer front, see figure 2.

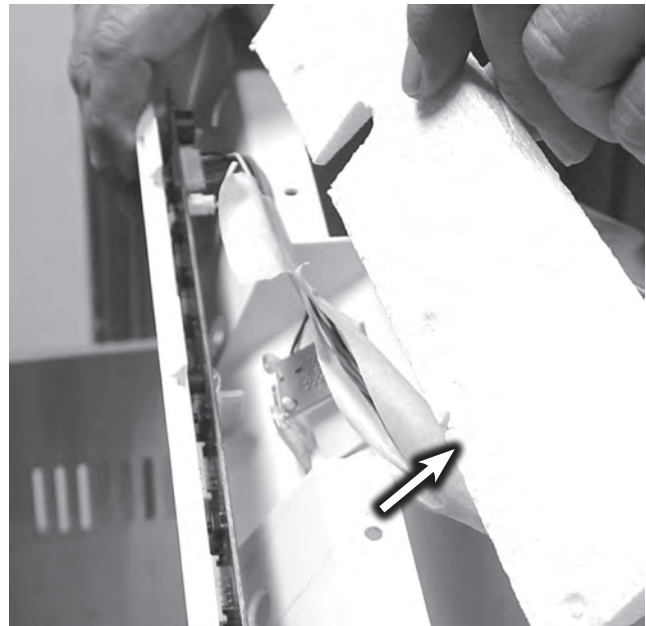

Figure 3

3. Remove the insulation between the housing and the user interface board, see figure 3.



Figure 4

4. Locate and remove the eight screws securing the user interface board to the housing.

NOTE: There are holes in the housing to allow access to the screw heads, see figure 4.

5. Lift out the user interface board, see figure 5.



Figure 5

INSTALLING THE USER INTERFACE BOARD

⚠ WARNING



Electrical Shock Hazard

Disconnect power before servicing.

Replace all parts and panels before operating.

Failure to do so can result in death or electrical shock.

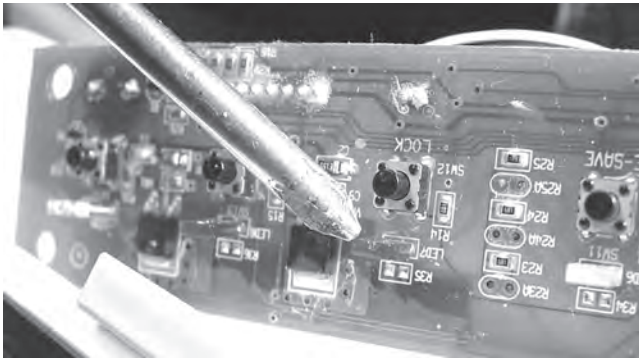

Figure 1

1. Locate the red and white LED lights located on the user interface board, see figure 1.



Figure 2

2. Locate the rectangular shaped holes in the housing, see figure 2.



Figure 3

3. Align the LED's on the user interface board and the slots in the housing.
4. Install the user interface board.

NOTE: Do not force the board into place. If the LED's are aligned with the holes in the housing the board will drop into place, see figure 3.

5. Install the screws.
6. Install the insulation.
7. Attach the housing to the front cover.

COMPONENT LOCATIONS

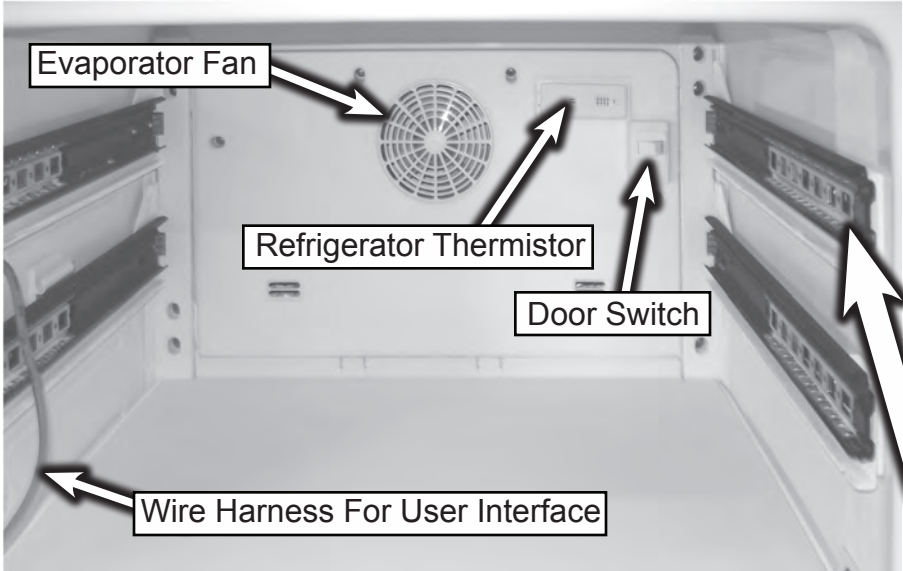

Figure 1

Refrigerator Components
See figure 1.

The side rail and slide assemblies lift up and out to remove, see figure 1.



Figure 2

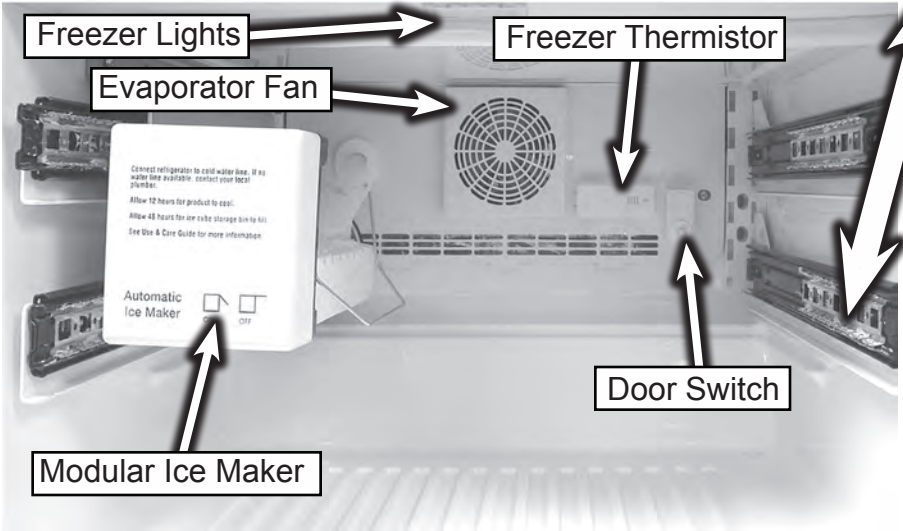

Figure 3

Freezer Components
See figure 3.

ICEMAKER

⚠ WARNING



Electrical Shock Hazard
Disconnect power before servicing.
Replace all parts and panels before operating.
Failure to do so can result in death or electrical shock.

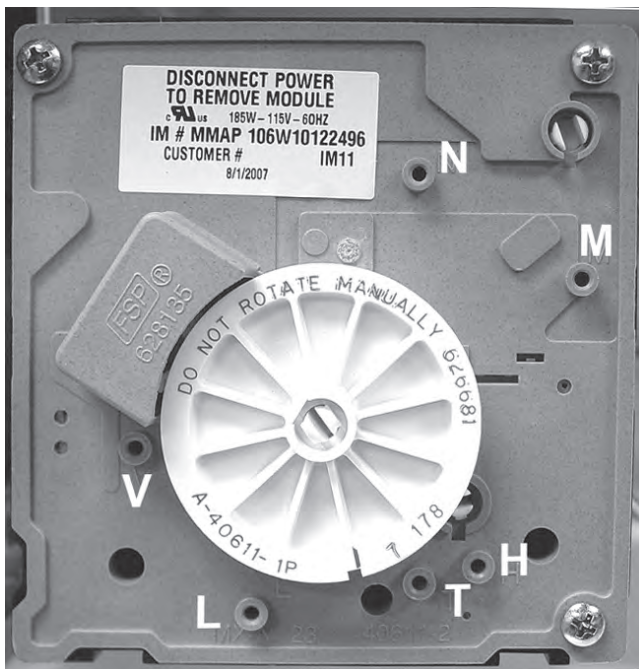

Figure 1

A standard 8 cavity modular ice maker is used on this product and can be tested and serviced the same as all other modular ice makers, see figure 1.

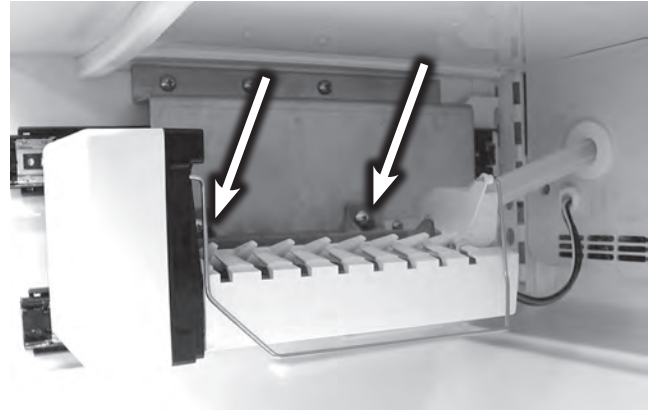

Figure 2

Icemaker Removal

1. Remove the 2 screws securing the ice maker to the mounting plate, see figure 2.

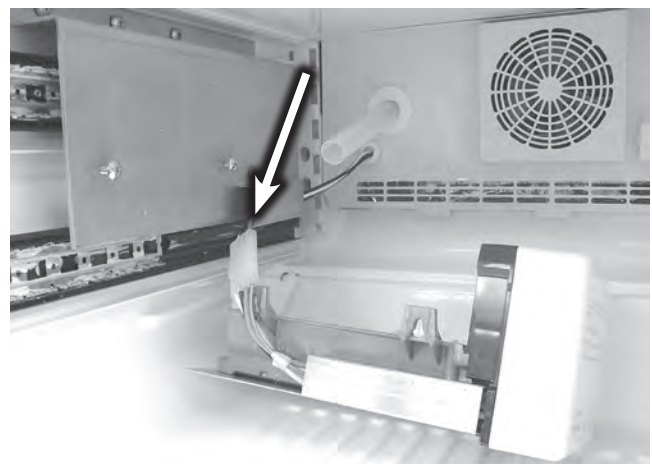

Figure 3

2. Drop down the ice maker.
3. Disconnect the wiring harness, see figure 3.



Figure 4



Figure 5

4. The fill tube can be removed by pulling straight out, see figures 4 and 5.

REMOVING THE SEPARATOR

⚠ WARNING



Electrical Shock Hazard

**Disconnect power before servicing.
Replace all parts and panels before
operating.**

**Failure to do so can result in death or
electrical shock.**

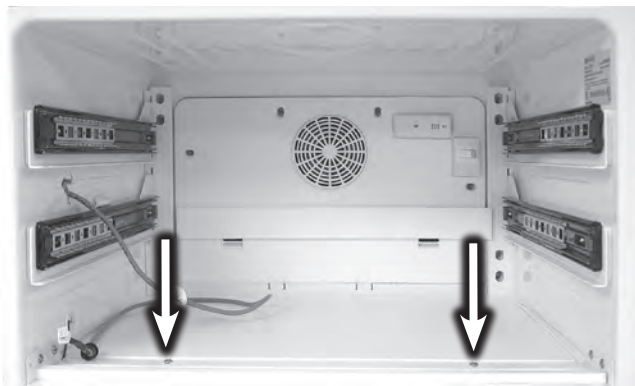

Figure 1

1. Remove the two screws securing the separator to the mullion rail, see figure 1.

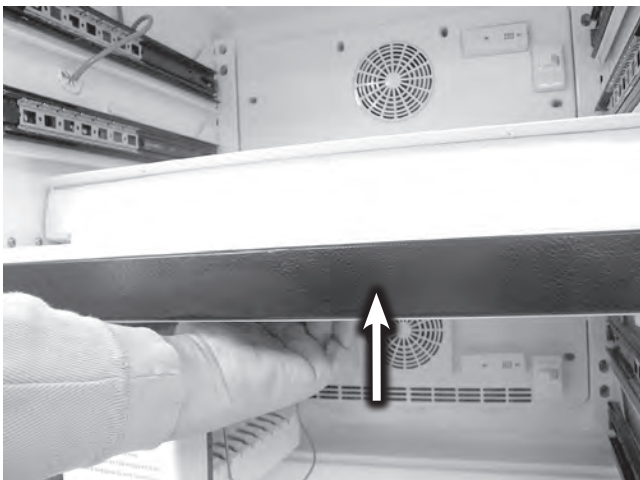

Figure 2

2. Push up on the bottom of the separator from the freezer section to free the separator from the cabinet, see figure 2.

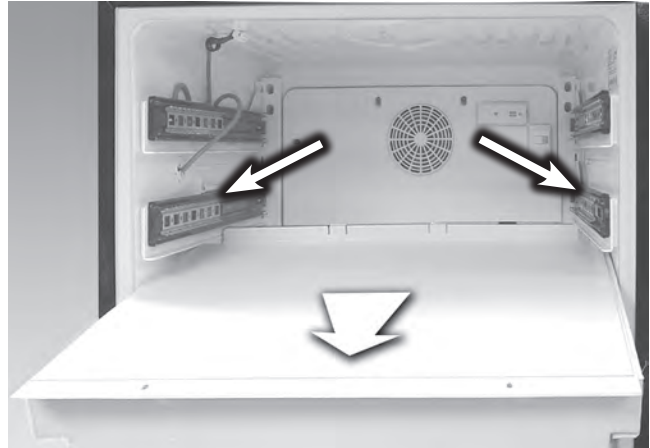

Figure 3

3. Slide the separator out of the cabinet.

NOTE: The separator can be removed with the side rails in place but it is easier if the rails are removed, see figure 3.



Figure 4

4. Remove screws around the perimeter of the evaporator cover securing it to the cabinet, see figure 4.

REMOVING THE SEPARATOR (continued)



Figure 5

5. Drop the evaporator cover down to access the wiring harness connector located in the top right hand corner, see figure 5.
6. Remove the 2 screws on the cover plate and remove, see figure 6.

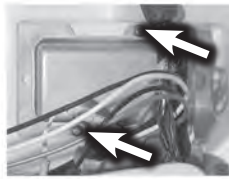

Figure 6

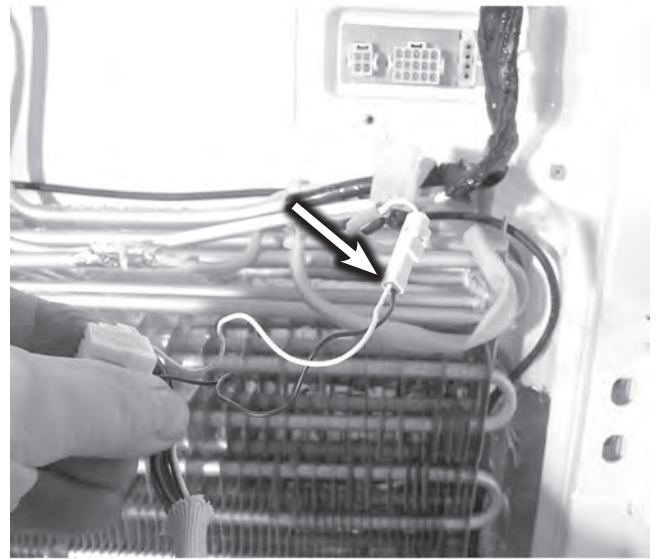

Figure 9

10. After disconnecting the wire harnesses, the evaporator cover can be removed, see figure 10.

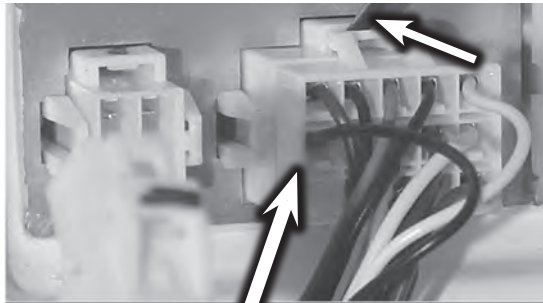

Figure 7



Figure 8

7. Disconnect three wiring harnesses, see figures 7 and 8.

NOTE: There are releases located on the top of two of the connectors that have to be depressed to remove the wire harness, see figure 7.

8. With the three harnesses removed from the block, the evaporator cover can be pulled out to access the remaining harness.
9. Disconnect harness, see figure 9.

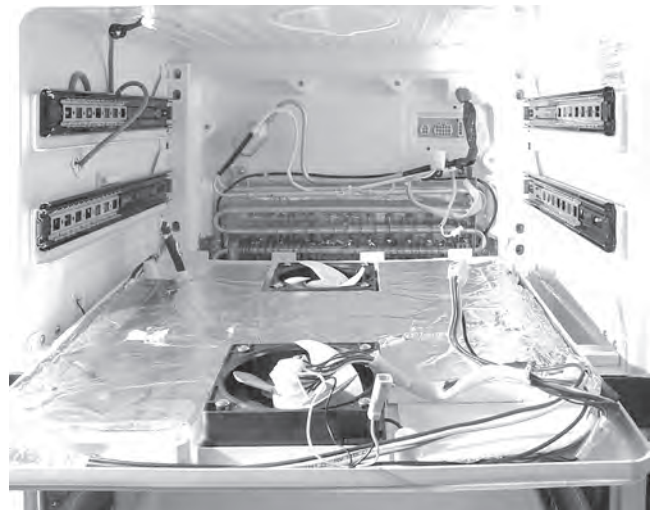

Figure 10

Continued on the next page

REMOVING THE SEPARATOR (continued)

Combo Unit Refrigerator/Freezer



Figure 11

The evaporator fan motors and Thermistors are serviced from the back side of the evaporator cover, see figure 11.

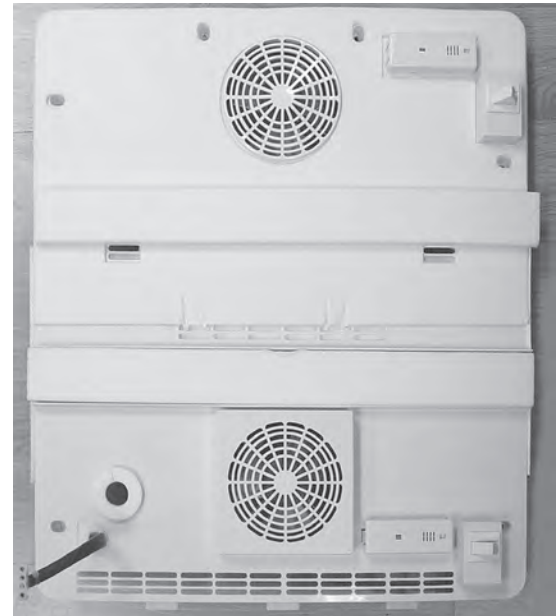

The evaporator cover for the refrigerator/freezer has insulation tape attached. The refrigerator cover does not.

All Refrigerator



EVAPORATOR COMPONENTS

⚠ WARNING



Electrical Shock Hazard
Disconnect power before servicing.
Replace all parts and panels before operating.
Failure to do so can result in death or electrical shock.

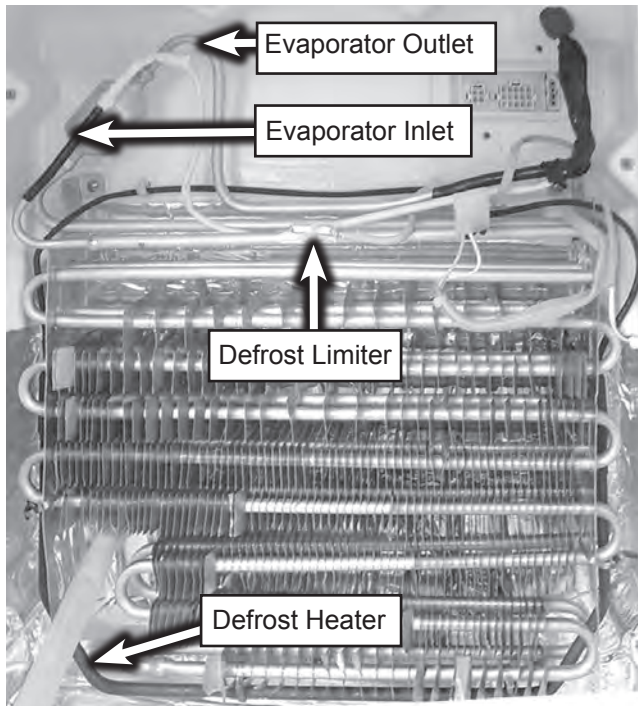

Figure 1

The defrost limiter is a one time thermal fuse that opens in case of an overheat condition, see figure 1.

Thermistor Service



Figure 2



Figure 3

The Thermistor clips into the housing, see figure 2. A piece of foam insulation is installed between the Thermistor and the evaporator cover, see figure 3.

Ice Maker Water Valve and Condenser Fan Removal

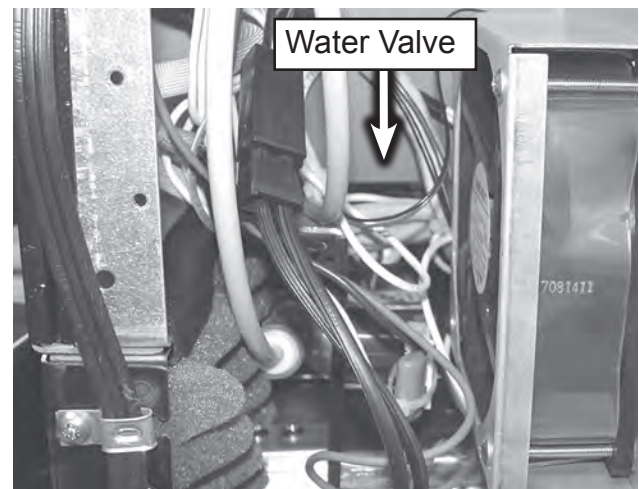

Figure 4

The ice maker water valve is located behind the condenser fan motor, see figure 4.

MACHINE COMPARTMENT COMPONENTS

⚠ WARNING



Electrical Shock Hazard
Disconnect power before servicing.
Replace all parts and panels before operating.
Failure to do so can result in death or electrical shock.



Figure 1a

Machine Compartment Components figures 1a, 1b, and 1c.



Figure 1b



Figure 1c

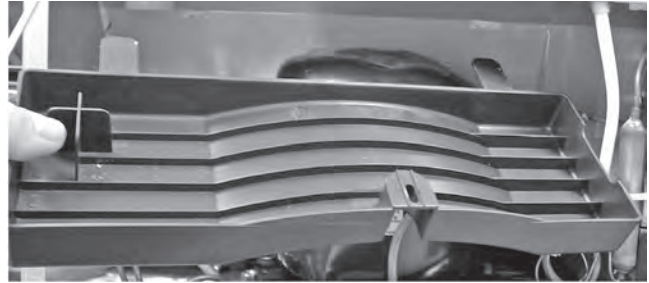

Figure 2

1. Remove screws securing the drain pan to the top of the machine compartment. The drain pan can now be removed.

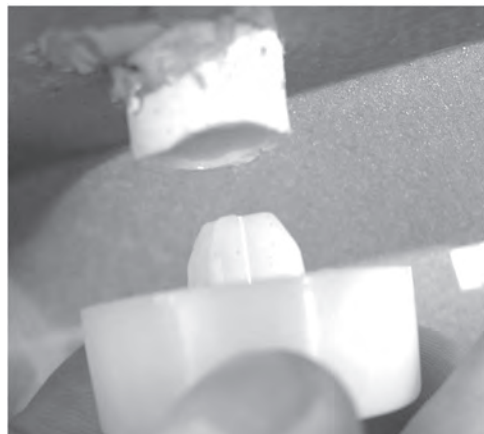

Figure 3

2. The drain trap can be removed by pulling it out of the drain tube, see figure 3.

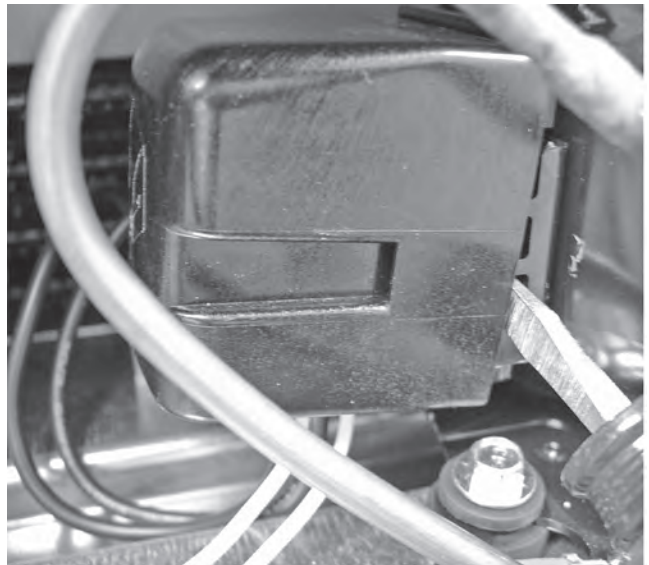
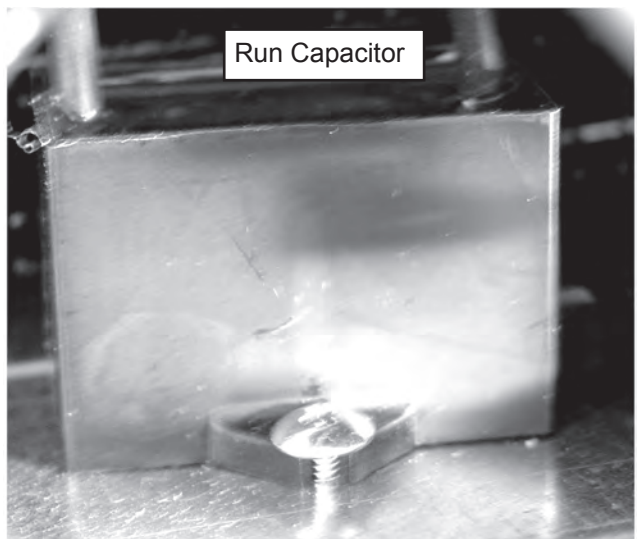
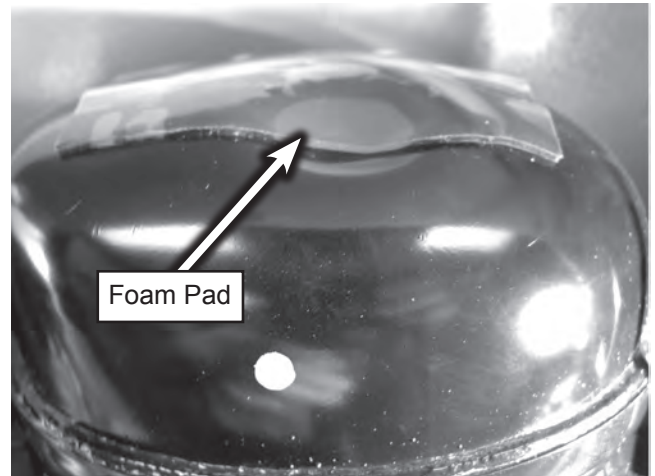
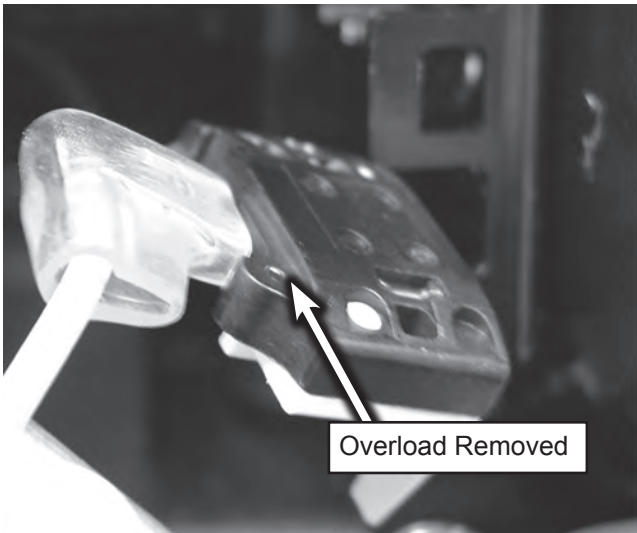
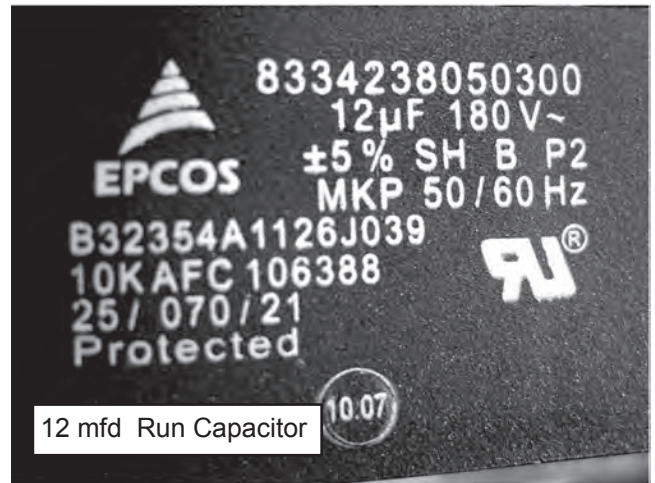
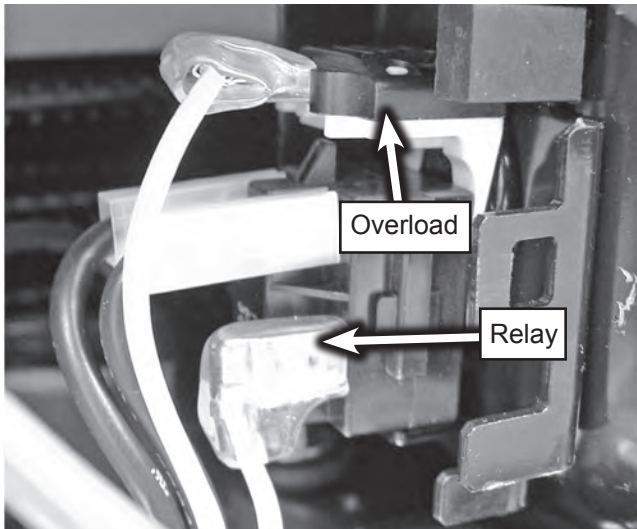

Figure 4

- The compressor terminal cover can be popped off to access the starting device, see figure 4.

MACHINE COMPARTMENT (continued)



REMOVING THE WATER VALVE

⚠ WARNING



Electrical Shock Hazard

Disconnect power before servicing.

Replace all parts and panels before operating.

Failure to do so can result in death or electrical shock.

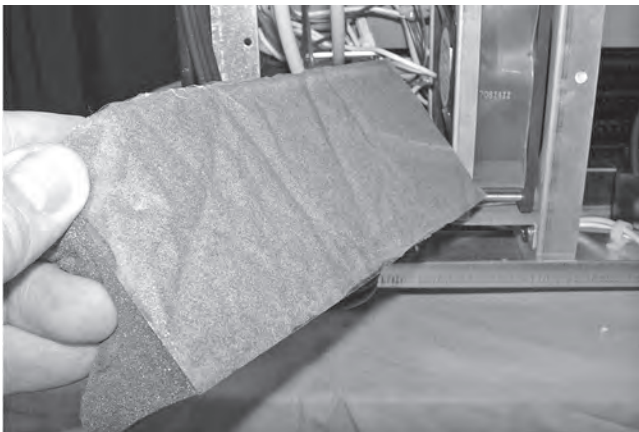

Figure 1

1. Remove insulation strip located next to left side of the cabinet, see figure 1.

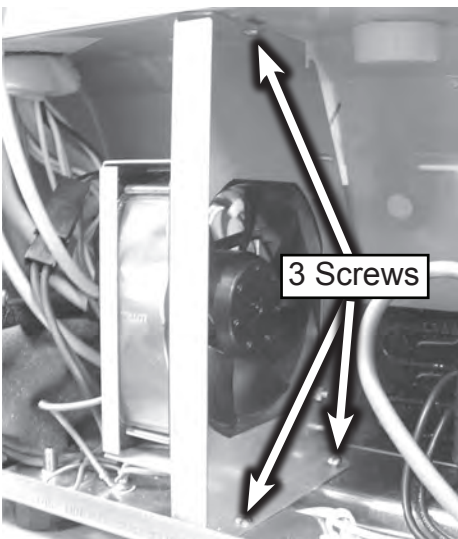

Figure 2

2. Remove three screws securing the condenser fan assembly to the cabinet, see figure 2.

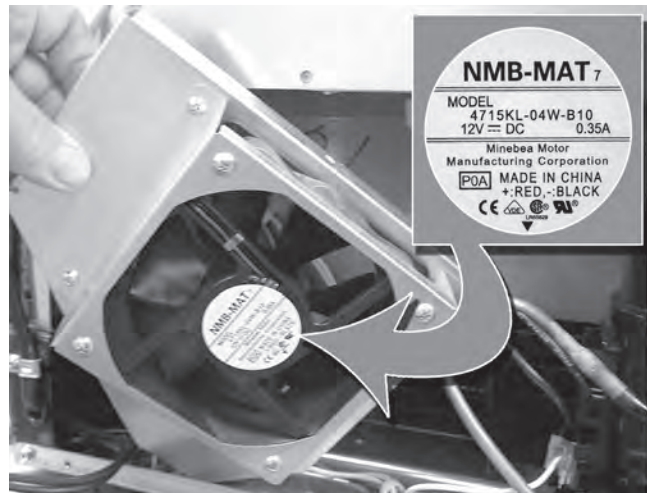

Figure 3

3. Remove the fan assembly, see figure 3.

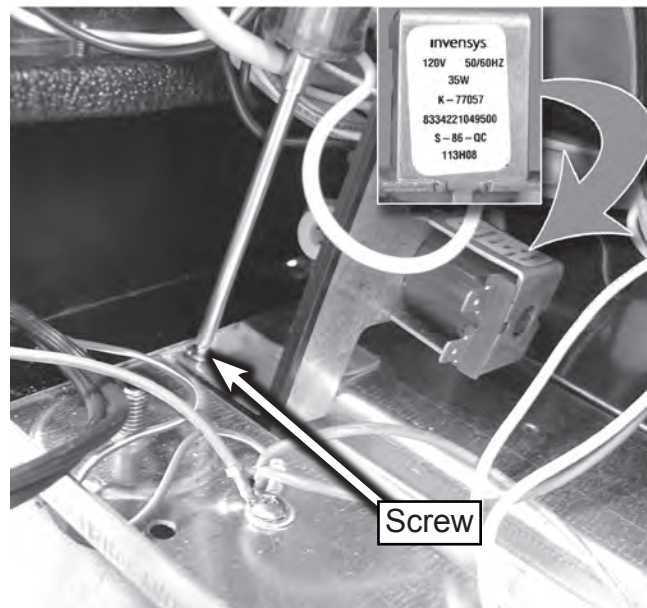

Figure 4

4. Remove the screw securing the water valve bracket to the cabinet, see figure 4.

CONDENSER AND PC BOARD

⚠ WARNING



Electrical Shock Hazard
Disconnect power before servicing.
Replace all parts and panels before operating.
Failure to do so can result in death or electrical shock.

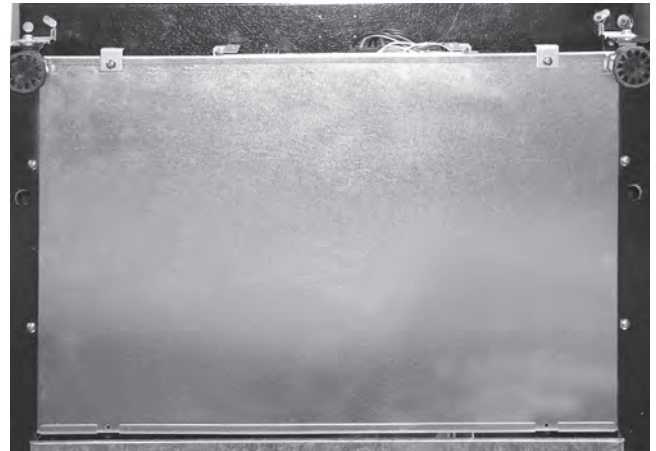
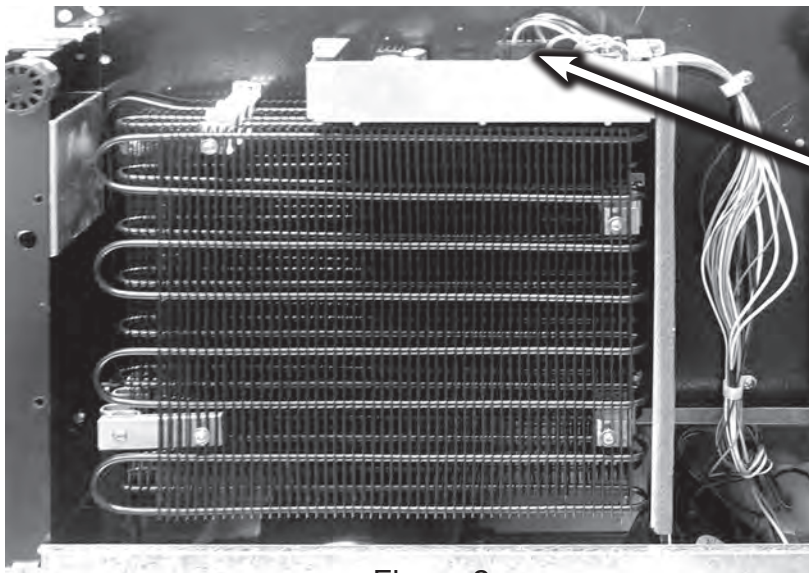

Figure 1

A metal plate covers the condenser, see figure 1.



PC Board

Condenser cover removed, Double Drawer refrigerator model, see figure 2.

Figure 2

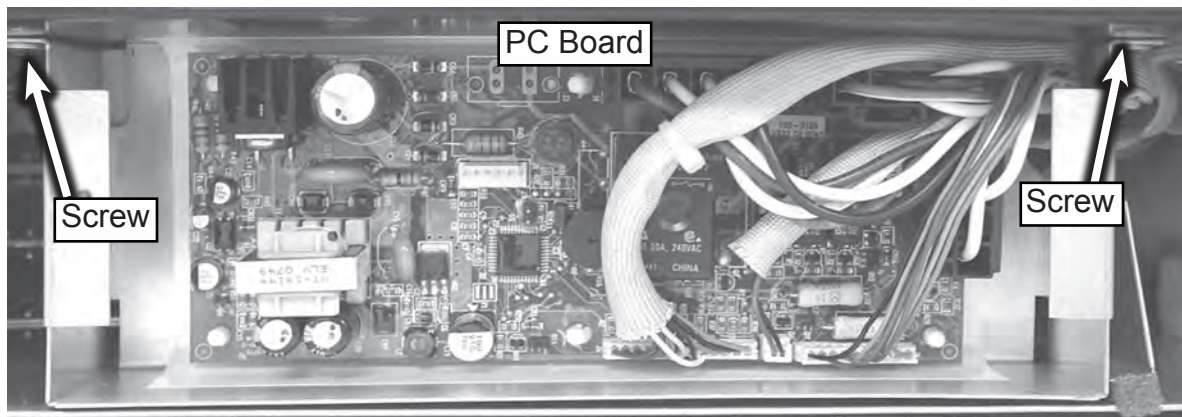

PC Board

Screw

Screw

Figure 3

Remove two screws and drop down the PC board assembly, see figure 3. This can be done without removing the pan in figure 2.

NOTES

DIAGNOSTICS AND TROUBLESHOOTING

MAIN PCB CONNECTOR FUNCTION

⚠ WARNING



Electrical Shock Hazard

Disconnect power before servicing.

Replace all parts and panels before operating.

Failure to do so can result in death or electrical shock.

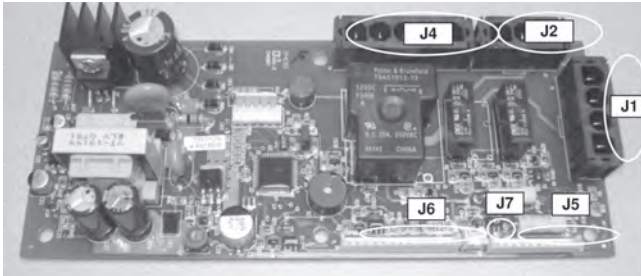

- J1** Defrost Heater, Thermal Fuse
- J2** Ice Maker
- J4** Power Supply, Compressor
- J5** Display, Lamp
- J6** Electrical Parts(Inside Cabinet)
- J7** Condenser Fan Motor
- J1** Defrost Heater, Thermal Fuse
- #1 pin connects to white wire
- #3 pin connects to yellow wire
- #1 and #3 pins show 120Vac only when defrost mode.

- J2** Ice Maker
- #1 pin connects to White wire, Water Valve and Ice Maker.
- #2 pin connects to Black wire and Ice Maker.
- #3 pin connects to Green/Yellow wire
- #1 and #2 pins supply 120Vac if Ice Maker button on display PCB is turned on.

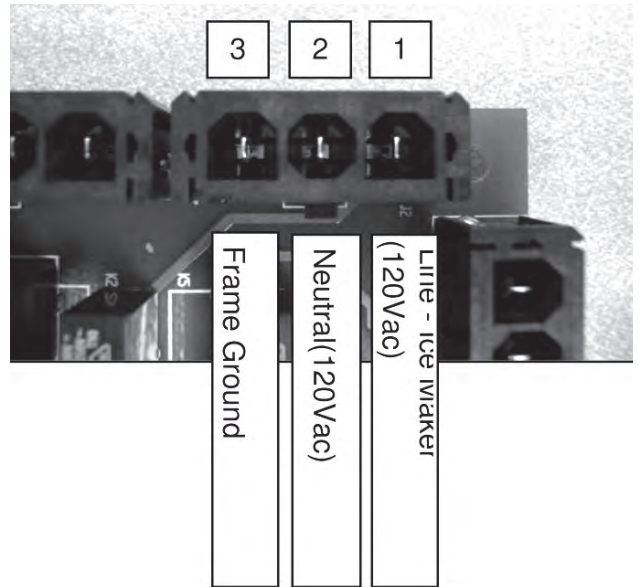
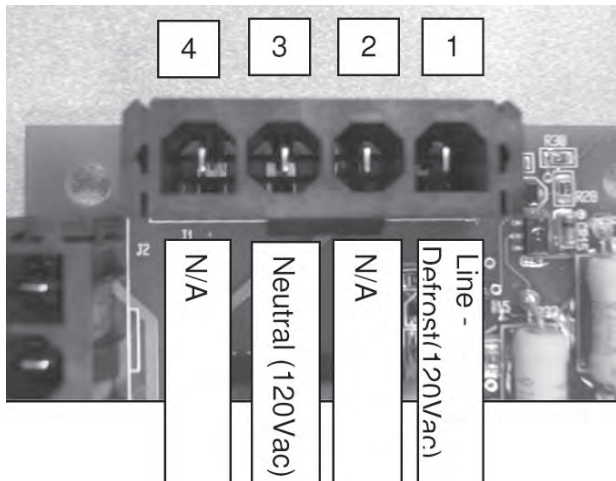

Continued on the next page.

MAIN PCB CONNECTOR FUNCTION (continued)

- J4** Power Supply, Compressor
- #1 pin connects to Green wire and Frame.
 - #2 pin connects to Black wire and Power Plug.
 - #3 pin connects to White wire and Compressor.
 - #4 pin connects to Yellow wire and Compressor.
 - #5 pin connects to Red wire and Power Plug.

#2 and #5 pins show 120Vac when a power plug was connected.

#3 and #4 pins show 120Vac only when a compressor is on.

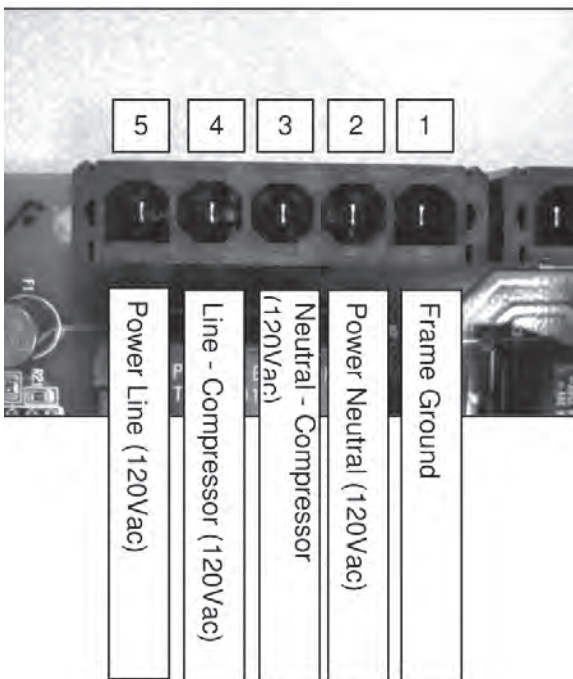

J5 Display, Lamp

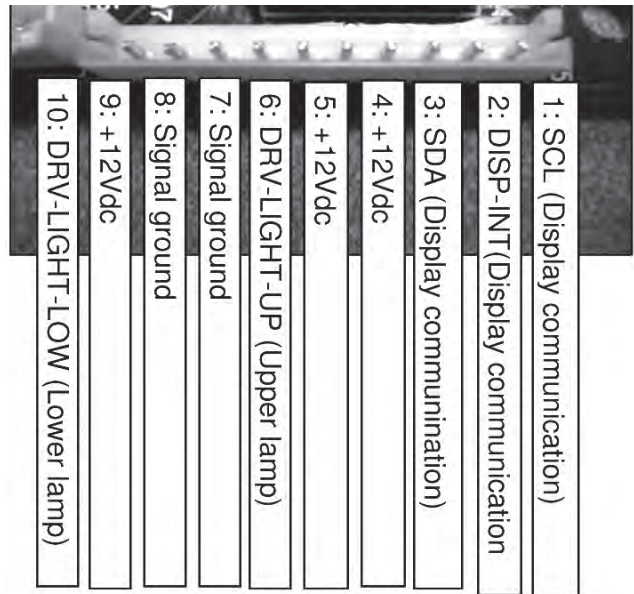

#1~#8 These pins go to Display PCB.

#9~#10 These pins go to lower lamp.

#1~#3 Sireal communication lines.

J6 Electrical Parts(Inside Cabinet)

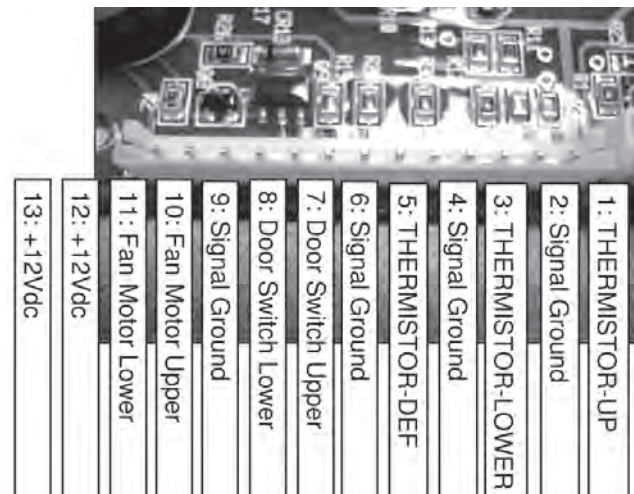

#1~#6 Sensor Lines

#7~#9 Door Switch Lines

#10~#13 Fan Motor Lines

#10(or #11) will be 0V when Upper Fan Motor is working.

#7 and #8 pins are pulled up to 5Vdc by MCU.

These pins will be 0V when door is opened. (Switch is open.)

MAIN PCB CONNECTOR FUNCTION (continued)

J7 Condenser Fan Motor

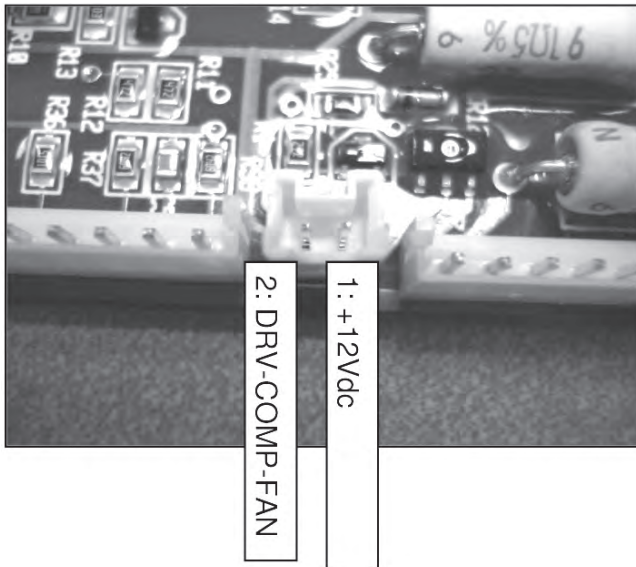

#2 will be 0V when Condensor Fan Motor is working.

DISPLAY PCB CONNECTOR FUNCTION

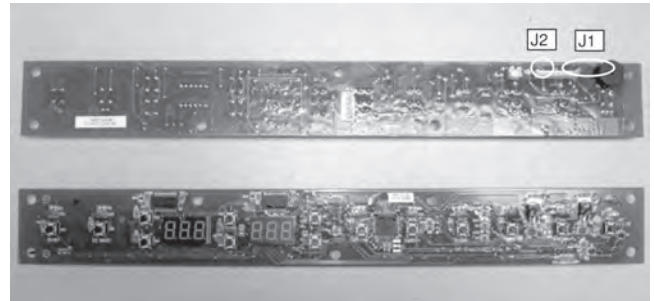

- J1 Main PCB
- J2 Upper Lamp

J1 Connect to Main PCB

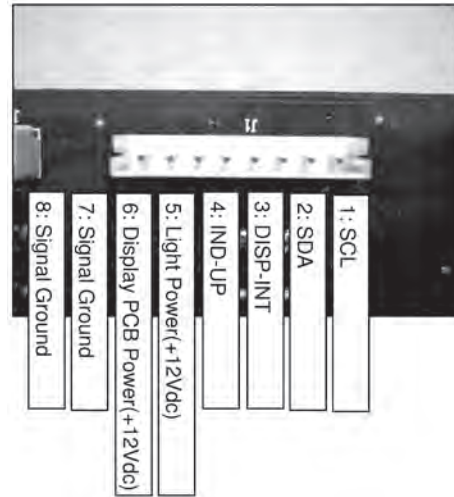

#1~#3 Sireal Communication with Main PCB

#4 #4 will be 0V when Upper lamp is on.(Upper door open)

J1 Connect to Main PCB

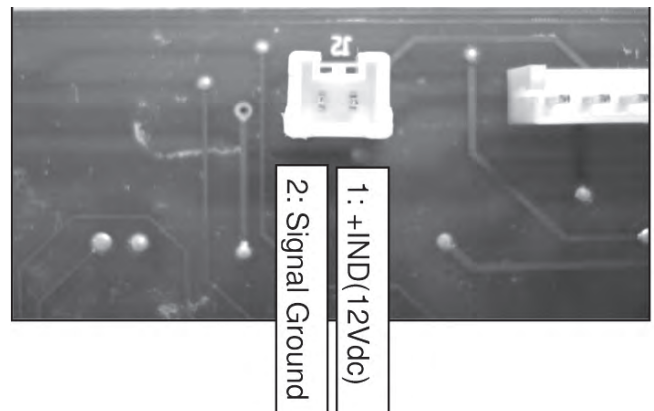

#1 #1 will be 0V when Upper lamp is on. (Upper door open)

BUILT-IN BOARD DIAGNOSTICS

Test User Interface Display

Press and hold "deg. C" and "-" simultaneously for 5 seconds to start the test mode.

The user interface will blink all of the 7-segment displays.

The LEDs will blink

The filter indicator LED will change color, yellow to red to none

Press and hold "deg. C" and "-" simultaneously for 5 seconds to exit the test mode.

Defrost Test

Press and hold "Max Cool" and "Holiday" simultaneously for 3 seconds to start the test mode.

The defrost heater will be energized immediately.

A dot will appear at the right end of the temperature display.

Press and hold "Max Cool" and "Holiday" simultaneously for 3 seconds to exit the test mode.

Energize evaporator fan motors and ice maker

Press "Max Cool" and "-" simultaneously for three seconds to enter the test mode.

The evaporator fans and ice maker circuits will be energized, by-passing the interior light switches and temperature control sequence.

Press "Max Cool" and "-" simultaneously for three seconds to exit the test mode.

Showroom Floor Display Mode

Press and hold "Cooling On/Off" and "Holiday Mode" for 3 seconds to enter the display test mode (this one is the most fun).

The cooling system and ice maker will not operate but the lights and user interface will be active.

Press and hold "Cooling On/Off" and "Holiday Mode" for 3 seconds to exit the display test mode

WIRING DIAGRAMS

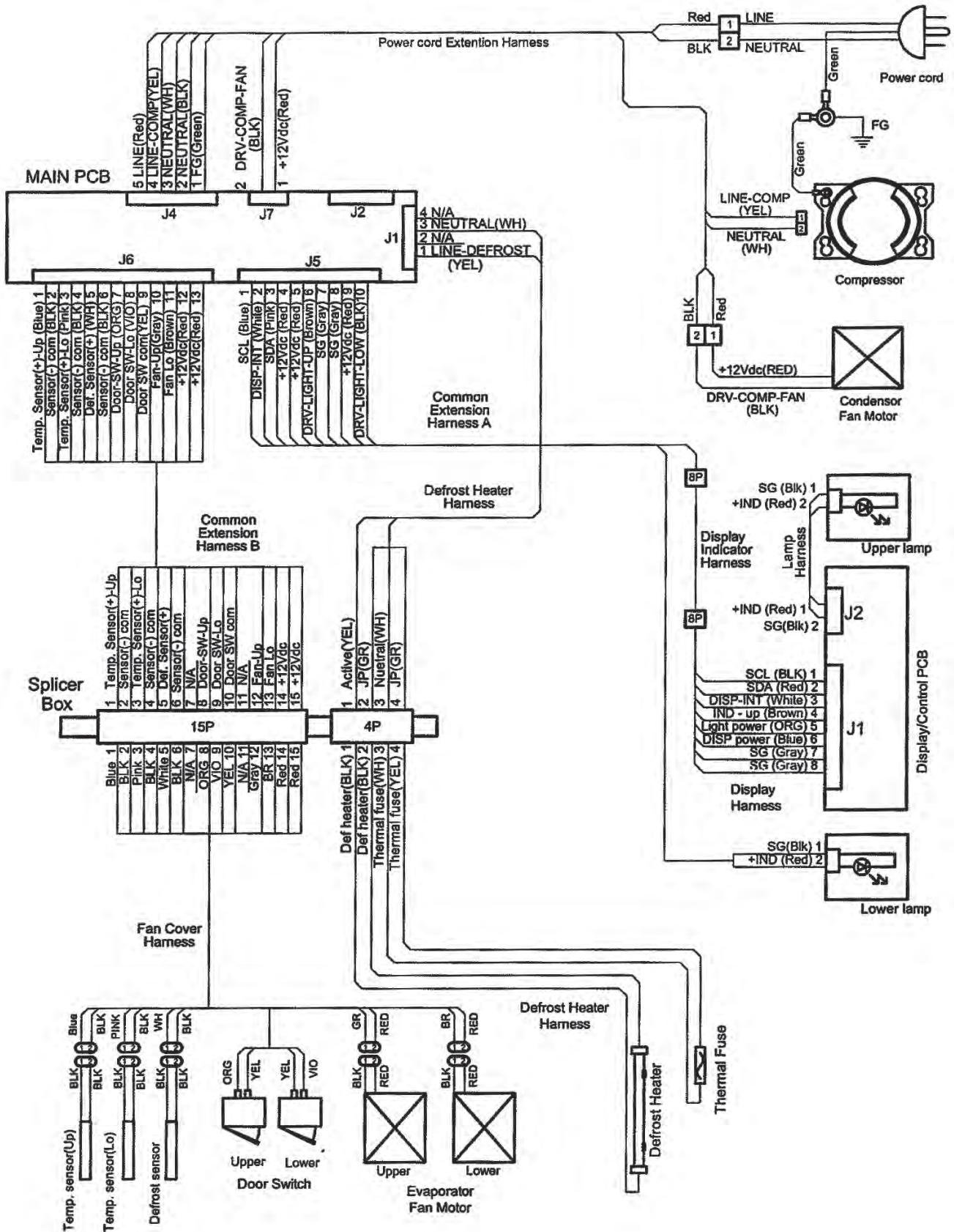

WIRING DIAGRAMS (continued)

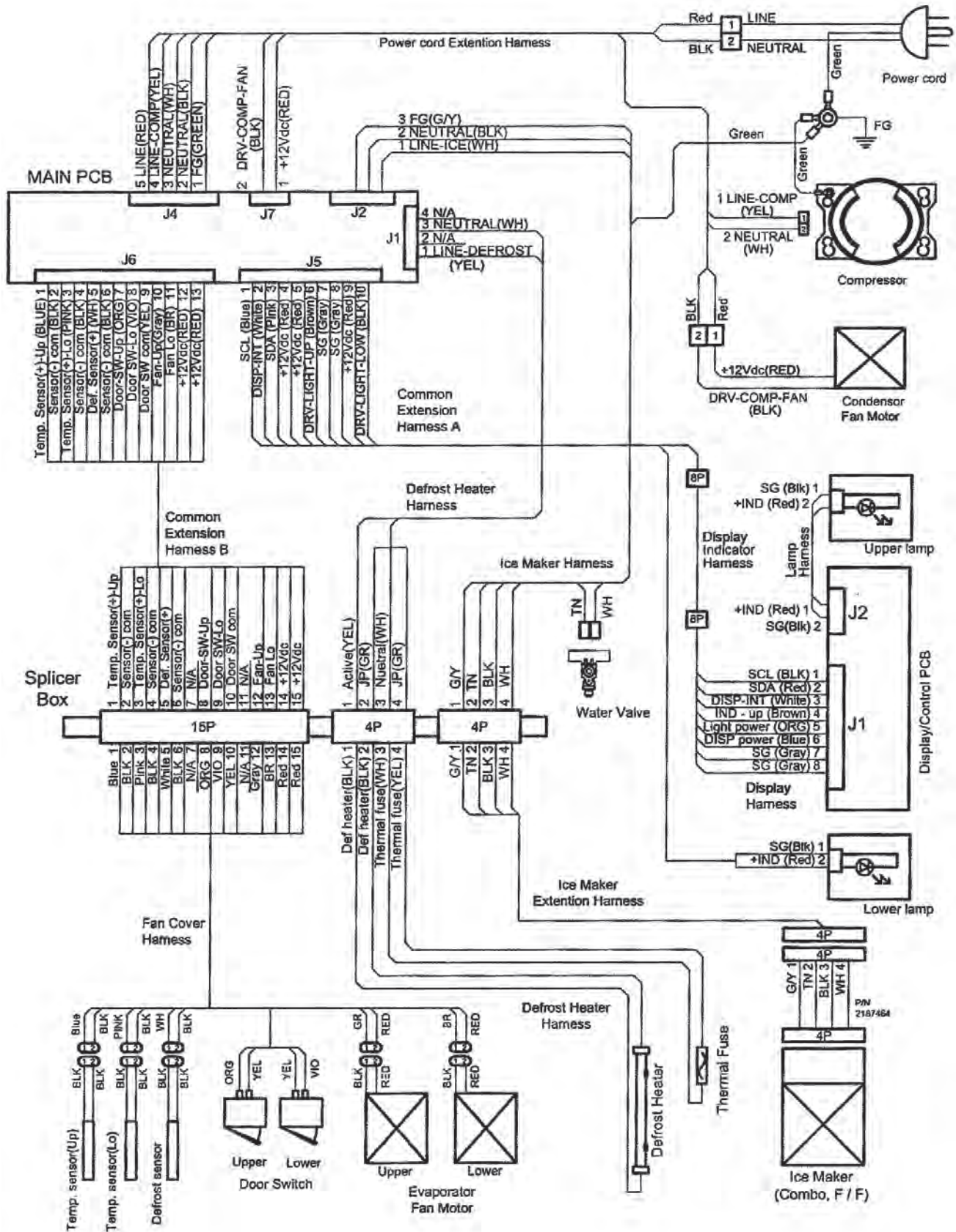

PRODUCT SPECIFICATIONS AND WARRANTY INFORMATION SOURCES

IN THE UNITED STATES:

FOR PRODUCT SPECIFICATIONS AND WARRANTY INFORMATION CALL:

FOR WHIRLPOOL PRODUCTS: 1-800-253-1301
FOR KITCHENAID PRODUCTS: 1-800-422-1230
FOR ROPER PRODUCTS: 1-800-447-6737

FOR TECHNICAL ASSISTANCE WHILE AT THE CUSTOMER'S HOME CALL:

THE TECHNICAL ASSISTANCE LINE: 1-800-832-7174

**HAVE YOUR STORE NUMBER READY TO IDENTIFY YOU AS AN
AUTHORIZED IN-HOME SERVICE PROFESSIONAL**

FOR LITERATURE ORDERS:

PHONE: 1-800-851-4605

FOR TECHNICAL INFORMATION AND SERVICE POINTERS:

www.servicematters.com

IN CANADA:

FOR PRODUCT SPECIFICATIONS AND WARRANTY INFORMATION CALL:

1-800-461-5681

FOR TECHNICAL ASSISTANCE WHILE AT THE CUSTOMER'S HOME CALL:

THE TECHNICAL ASSISTANCE LINE: 1-800-488-4791

**HAVE YOUR STORE NUMBER READY TO IDENTIFY YOU AS AN
AUTHORIZED IN-HOME SERVICE PROFESSIONAL**

KitchenAid®
FOR THE WAY IT'S MADE.®

