

SERVICE MANUAL

27" Dryers

Gas & Electric

Models with

Electronic Controls

SAFE SERVICING PRACTICES - ALL APPLIANCES

To avoid personal injury and/or property damage, it is important that **Safe Servicing Practices** be observed. The following are some limited examples of safe practices:

1. **DO NOT** attempt a product repair if you have any doubts as to your ability to complete it in a safe and satisfactory manner.
2. Before servicing or moving an appliance:
 - Remove the power cord from the electrical outlet, trip the circuit breaker to the OFF position, or remove the fuse.
 - Turn off the gas supply.
 - Turn off the water supply.
3. Never interfere with the proper operation of any safety device.
4. **USE ONLY REPLACEMENT PARTS CATALOGED FOR THIS APPLIANCE. SUBSTITUTIONS MAY DEFEAT COMPLIANCE WITH SAFETY STANDARDS SET FOR HOME APPLIANCES.**
5. **GROUNDING:** The standard color coding for safety ground wires is **GREEN**, or **GREEN** with **YELLOW STRIPES**. Ground leads are not to be used as current carrying conductors. It is **EXTREMELY** important that the service technician reestablish all safety grounds prior to completion of service. Failure to do so will create a hazard.
6. Prior to returning the product to service, ensure that:
 - All electrical connections are correct and secure
 - All electrical leads are properly dressed and secured away from sharp edges, high-temperature components, and moving parts
 - All non-insulated electrical terminals, connectors, heaters, etc. are adequately spaced away from all metal parts and panels
 - All safety grounds (both internal and external) are correctly and securely connected
 - All panels are properly and securely reassembled

ATTENTION!!!

This service manual is intended for use by persons having electrical and mechanical training and a level of knowledge of these subjects generally considered acceptable in the appliance repair trade. Electrolux Home Products cannot be responsible, nor assume any liability, for injury or damage of any kind arising from the use of this manual.

SAFE SERVICING PRACTICES	2
QUICK REFERENCE SHEET	7 - 11
Serial nameplate location	7
Serial number breakdown	7
Tech sheet location	7
Failure codes	8
On line test	8
Specification	10
Component resistance chart	11
Sample wiring diagrams	12 - 13
Sample wiring diagram for electric models	12
Sample wiring diagram for gas models	13
SECTION A - OPERATING INSTRUCTIONS	14 - 17
Before operating your dryer	14
Operating steps	14
Cycle Selection	14 - 15
Normal	15
Quick	15
Towels	15
Perm Press	15
Knits / Delicates	15
Touch Up	15
Cycle Adjustment	15
Temperature Selection	15
Dryness Selection	15
Cycle Options	15
Press Saver	15
Air Fluff/No Heat	16
Dryer Features	16
Control Lock	16
Signal	16
Time Dry	16
Error Codes	16
Dryer settings reference chart	17
SECTION B - OWNERS GUIDE	18 - 26
Safety information	18 - 19
What to do if you smell gas	18
Your Safety and the Safety of other is very Important	18
Pedestal	18
Important safety instructions	18
Prevent fire	18
Protect children	19
Prevent injury	19
Drying Procedures	20
Features	21
End of cycle signal	21
Drum light	21
Reversible dryer door	21
Drying rack	21
Common drying problems	22
Care and cleaning	23
Inside	23
Outside	23
Avoid service checklist	24 - 25
Sample Warranty	26

SECTION C - INSTALLATION INSTRUCTIONS GAS & ELECTRIC DRYER	27 - 36
What to do if you smell Gas	27
Pre-installation requirements	28
Tools and materials required for installation	28
Electrical requirements	28
Electric dryers	28
Gas dryers	28
Exhaust system requirements	28
Exhaust directions	30
Exhaust duct locating dimensions	30
Gas supply requirements	30
Location of your dryer	30
Do not install your dryer	30
Installation in a recess or closet	30
Minimum installation clearances	30
This dryer must be exhausted outdoors	30
Under counter installation	31
Mobile home installation	31
Rough-in dimensions	32
Unpacking	33
Reversing door swing	33
Electrical installation	33
Electric dryers	33
Grounding requirements	34
For a grounded, cord-connected dryer	34
For a permanently connected dryer	34
Gas dryer	34
Electrical connections for 3-wire system	34
Electrical connections for 4-wire system	35
Gas connection	35
General installation	35
Replacement parts	36
SECTION D - STACKING INSTRUCTIONS	37 - 38
Tool & equipment requirements	37
Kit components	37
Remove washer top panel	37
Install mounting brackets	37
Install dryer support spacer	38
Prepare dryer for stacking	38
Stack the dryer	38
Washer and dryer operation	38
SECTION E - HOW THE COMPONENTS WORK	39 - 47
The basic components	39 - 40
Drum	39
Heat source	39
Electric	39
Gas	39
Drive motor and blower	39
Control thermistor	40
Electronic control board	40
Airflow	40
Airflow electric dryers	40
Airflow gas dryers	41
Airflow problems	42
Restrictions	42
Air leaks	42

Short unrestricted vents _____	42
Electrical operation (Electric dryers models) _____	42- 44
Electronic control board circuits _____	43
Drive motor circuit _____	43
Temperature sensing circuit _____	43
The heating circuit _____	44
Drying time _____	44
Electrical Operation (Gas Dryers Models) _____	44 - 47
Electronic control board circuits _____	45
Drive motor circuit _____	45
Temperature sensing circuit _____	45
The heating circuit _____	45
Drying time _____	46
SECTION F - TROUBLESHOOTING FLOW CHARTS _____	48 - 56
Electric dryer completely inoperative _____	49
Gas dryer completely inoperative _____	50
Electric and gas dryers; blower motor runs but drum does not turn _____	51
Electric and gas dryers; longer than normal drying times _____	51
Electric dryer not heating properly _____	52
Gas dryer not heating properly _____	53
Electric and gas dryers; dryer over heating _____	53
Electric dryers; blower motor runs but dryer does not heat _____	54
Gas dryers; blower motor runs but dryer does not heat _____	55
Electric and Gas dryers; clothes not dry in auto cycle _____	56
SECTION G - TEARDOWN _____	57 - 71
Removing the top panel _____	57
Removing the console drip rail _____	57
Removing the front panel _____	57
Removing the electronic control and display _____	58
Removing the console _____	59
Removing the console front panel with touch pad _____	60
Removing the door _____	60
Separating the door panel _____	60
Removing the door seal _____	60
Removing the door handle _____	61
Removing the door strike _____	61
Removing the door hinge _____	61
Removing the door catch _____	61
Removing the door switch _____	61
Removing the sensor bars _____	62
Replacing the drum light bulb _____	62
Replacing the drum light housing _____	62
Replacing the drum light socket _____	62
Replacing the felt seal _____	63
Replacing the foam seal _____	63
Removing the rear vent _____	63
Releasing the dryer belt _____	63
Removing the vane from the drum _____	64
Removing the drum _____	64
Removing the belt _____	64
Removing the hitch ball from the drum _____	65
Removing the teflon glides _____	65
Removing the drum heat shield (Electric dryers) _____	65
Removing the hitch _____	65
Removing the high limit thermostat _____	66

Removing the thermal limiter (Electric dryers)	66
Removing the heating element assembly (Electric dryers)	66
Removing the control thermistor	66
Removing the blower housing and fan blade	67
Removing the idler pulley	68
Removing the idler pulley assembly	68
Removing the drive motor	68
Removing the burner (Gas dryers)	68
Removing the ignitor (Gas dryers)	68
Removing the gas valve assembly (Gas dryers)	69
Removing the gas valve coils (Gas dryers)	69
Removing the sensor (Gas dryers)	70
Removing the combustion chamber (Gas dryers)	70
Removing the duct and heat shield (Gas dryers)	70
Removing the manifold pipe (Gas dryers)	70
Removing the vent pipe (Gas dryers)	71
Removing the gasket between the vent pipe and blower housing	71

QUICK REFERENCE SHEET

1. Serial nameplate location: on the front panel at the left side of the dryer door opening.



2. Serial number breakdown.

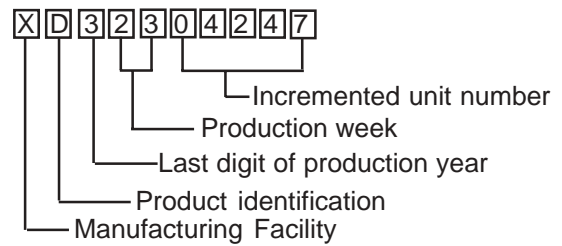

3. Tech sheet location

Front console models: on the right-hand bodyside behind the front panel and inside rear access panel.

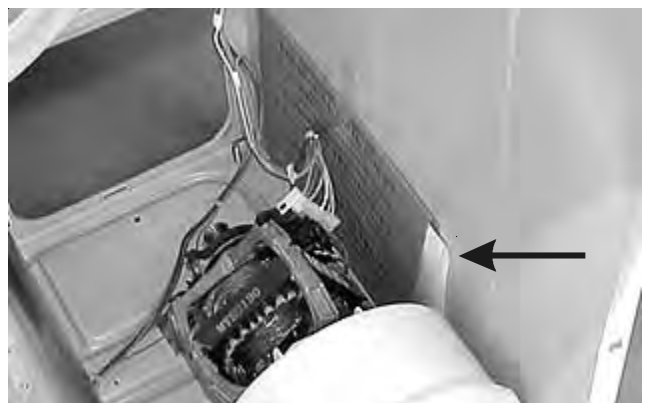

QUICK REFERENCE SHEET

Failure codes:

Display shows: F 04

Display shows: F 01

Indicates: An internal fault in the control.

Correction: Touch the **Stop/Clear** pad. If the display continues to display F 01 or if the code returns when the dryer is restarted, replace the control.

Indicates: The drying time has exceeded the program time for that cycle.

Correction: Touch the **Stop/Clear** pad. Program the dry for a NORMAL CYCLE with HIGH HEAT and touch START. Check for anything that would extend the dry time such as:

Display shows: F 02

Indicates: Control temperature sensor open or shorted.

Correction: Removed the wires from the control temperature sensor and measure the resistance of the sensor. If the meter does not read 50,000 Ohms +/- 10% replace the sensor. If the meter reading is within 10% of 50,000 Ohms, check the wiring between the electronic control board and the sensor. If the wiring is good, replace the electronic control board.

1. Dryer not heating.

2. Restricted vent.

3. Blower fan blade broken or loose.

4. Dryer installed in a closet with a solid door.

5. Bad connect in sensor bar circuit or dirty sensor bars.

If the dryer operates normally but the F 04 code returns, replace the control.

Display shows: F 03

Indicates: No heat

Correction: Touch the **Stop/Clear** pad to clear the F 03. Program the dry for a NORMAL CYCLE with HIGH HEAT and touch START. Measure the voltage drop across the terminals of relay RL 2 on the electronic control board. If the meter reads 240 VAC on electric models or 120 VAC on gas models, replace the electronic control board. If the meter reads zero, remove power from the dryer and disconnect the black wire electric models and orange wire gas models from the relay. Reconnect power and measure the voltage drop between red wire on the relay RL 2 to neutral. If the meter reads zero, the wire between the incoming line and relay RL 2 is open. If the meter reads 120 VAC, check the rest of the heating circuit as described in the trouble shooting section.

Display shows: F 05

Indicates: A problem with the key pad.

Correction: Disconnect the keypad ribbon from the control and reconnect the ribbon. Try all keypad switches to see they all function correctly. If they do not, try cleaning the end of the ribbon with a soft cotton cloth. Reinstall the ribbon and program the dryer to operate. If the code, reoccurs replace the touch pad.

Note: See control removal instruction on how to disconnect ribbon.

On line test:

To start the test programs, remove power from the dryer. Reconnect power to the dryer and within 10 seconds press and hold the temp and the stop pads for at least 2 seconds, then release. The control is now in the test function.

1. After activation, the WRINGLE RID icon should be on.

QUICK REFERENCE SHEET

2. Touch the start pad and the test will advance to the HEAT test. (H) will appear in the display, the drive motor will run and the electric heating element or gas burner will operate depending on the model.
3. Retouch the start pad and the test will advance to the AIR FLUFF test. (AF) will appear in the display and the drive motor will run.
4. Retouch the start pad and the test will advance to the AUTO DRY MOISTURE COUNTS test. The AUTO DRY icon will illuminate and a number will appear in the display. Open the door, place your hand against the sensor bars and the amount of the number in the display should go down.
5. Retouch the start pad and the test will advance to the MEMBRANE test. The display will be blank. Press each cycle pad and the LEDs should light.
6. Retouch the start pad and the test will advance to the COOL DOWN test. The COOL DOWN icon will illuminate and a number will appear in the display and the drive motor will run.
7. Retouch the start pad and the test will advance to the TIME DRY test. The TIME DRY icon will illuminate and a number will appear in the display. The drive motor will run and the electric heating element or gas burner will operate depending on the model.

Press Start to repeat the test. To remove the dryer from the test mode, disconnect power to the dryer or press and hold the stop and cycle pads for at least 2 seconds then release.

QUICK REFERENCE SHEET

SPECIFICATION	ELECTRIC MODELS	GAS MODELS
Electrical		
Volts 120/208 or 120/240	120/208 or 120/240	120
Amps (circuit)	30	15
Motor wattage	160-350 Watts	160-350 Watts
Heat input (Watts @ 240 VAC)	3200/4500	---
Heat input (BTU/Hr.)	---	20,000
Auto. Elec. Ignition	---	Yes
Drum		
Size (Cu. Ft.)	5.7	5.7
Finish	Power Paint Epoxy	Power Paint Epoxy
R.P.M.	48 - 54	48 - 54
Airflow CFM	200	200
DRUM TEMPERATURES (Max. opening on 1st cycle)		
High	145° - 190°	145° - 190°
Medium	140° - 180°	140° - 180°
Low	135° - 175°	135° - 170°
Dimension (Inches)		
Height (Stack Models)	35 1/4"	35 1/4"
Width	26 7/8"	26 7/8"
Depth	27"	27"
Vent Capability**	4-Way	3-Way
Top Finish	Power Paint Enamel	Power Paint Enamel
Port Opening (Sq. In.)	235	235

** Electric dryers can be vented four ways: through back, bottom, right or left side.

** Gas dryers can be vented three ways: through back, bottom, or right side.

QUICK REFERENCE SHEET

Component Resistances*	Electric Models	Gas Models
Drive motor (120 volt, 60 Hz, 1/4 h.p. 1725 rpm)		
Motor Start Winding	4.5 Ohms	4.5 Ohms
Motor Run Winding	3.8 Ohms	3.8 Ohms
Heating Element	12.8 Ohms	
Control Thermistor	50,000 Ohms	50,000 Ohms
Burner Assembly		
Ignitor	---	50 - 400 Ohms
Secondary Coil	---	1200 Ohms
Booster Coil	---	1320 Ohms

* +/- 10% @ 77° F

SAMPLE WIRING DIAGRAM FOR ELECTRIC MODELS

CAUTION: DISCONNECT ELECTRIC CURRENT BEFORE SERVICING. LABEL ALL WIRES PRIOR TO DISCONNECTION WHEN SERVICING CONTROLS. WIRING ERRORS CAN CAUSE IMPROPER AND DANGEROUS OPERATION. VERIFY PROPER OPERATION AFTER SERVICING.

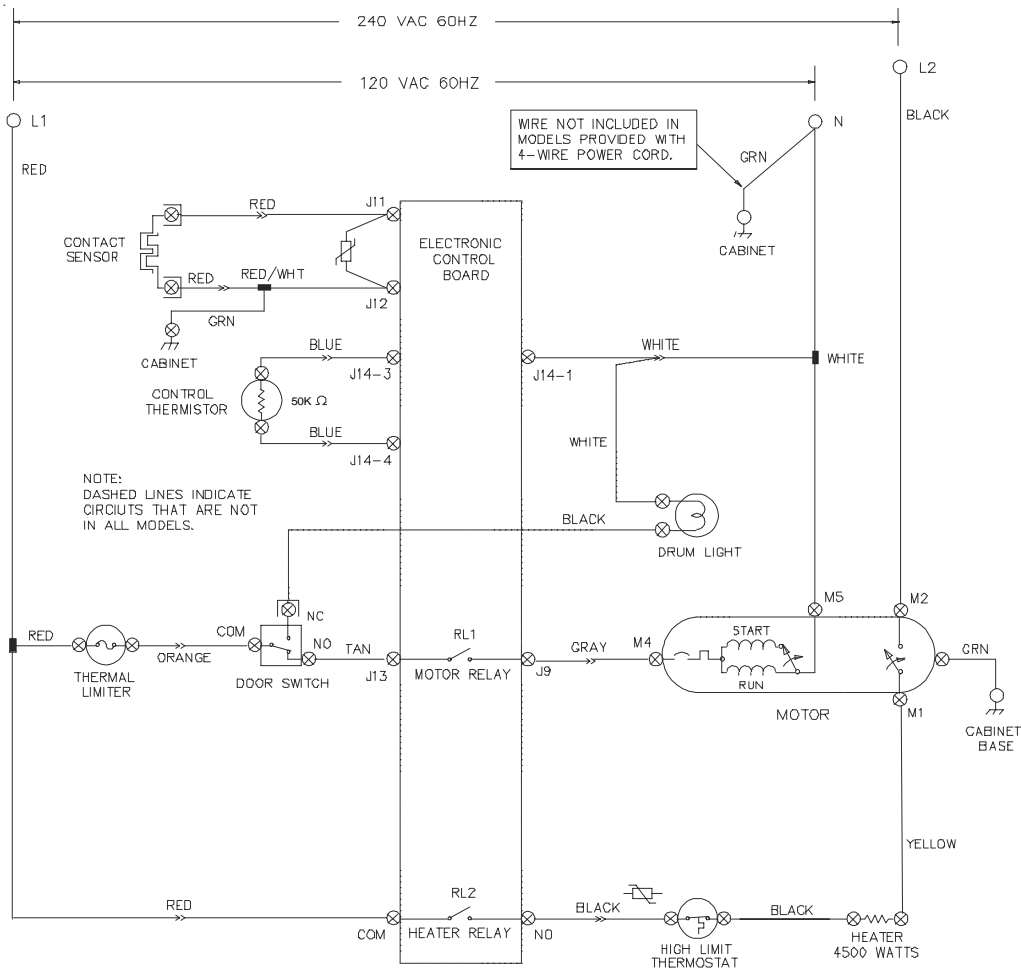

WIRING CODES	
	QUICK DISCONNECT TERMINAL
	CONNECTION
	NO CONNECTION
	MOTOR SWITCH
	SPLICE
	MOTOR PROTECTOR
	CHASSIS (CABINET) GROUND
	SCREW TERMINAL
	HARNESS CONNECTOR TERMINAL
	INSULATED TERMINAL
	TRANSIENT VOLT SUPPRESSOR

- NOTES:**
1. ALL WIRING MUST CONFORM TO LOCAL ELECTRICAL CODES.
 2. CONNECT DRYER TO A 30 AMPERE INDIVIDUAL BRANCH CIRCUIT.
 3. CONTROL SHOWN IN OFF POSITION, DOOR SWITCH CLOSED & MOTOR AT REST.

SAMPLE WIRING DIAGRAM FOR GAS MODELS

CAUTION: DISCONNECT ELECTRIC CURRENT BEFORE SERVICING. LABEL ALL WIRES PRIOR TO DISCONNECTION WHEN SERVICING CONTROLS. WIRING ERRORS CAN CAUSE IMPROPER AND

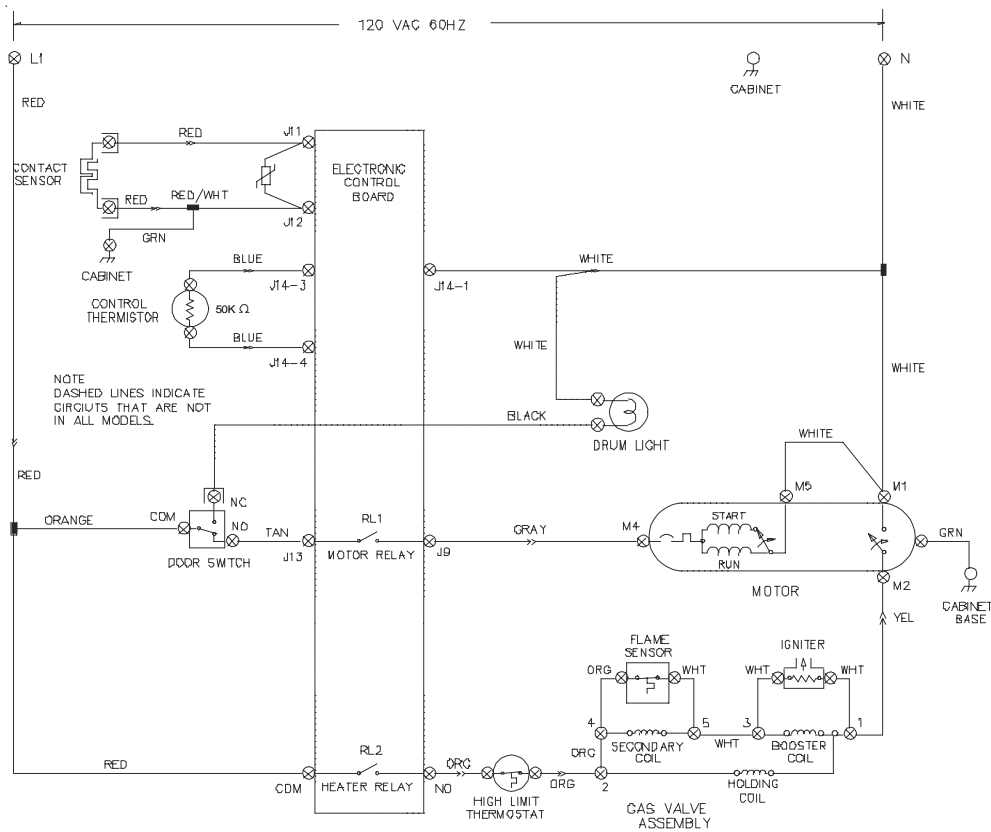

WIRING CODES	
	QUICK DISCONNECT TERMINAL
	CONNECTION
	NO CONNECTION
	MOTOR SWITCH
	SPLICE
	MOTOR PROTECTOR
	CHASSIS (CABINET) GROUND
	SCREW TERMINAL
	HARNES CONNECTOR TERMINAL
	INSULATED TERMINAL
	TRANSIENT VOLT SUPPRESSOR

- NOTES:
- 1 ALL WIRING MUST CONFORM TO LOCAL ELECTRICAL CODES.
 - 2 CONNECT DRYER TO A 15 AMPERE INDIVIDUAL BRANCH CIRCUIT.
 3. CONTROL SHOWN IN OFF POSITION, DOOR SWITCH CLOSED & MOTOR AT REST.

SECTION A - OPERATING INSTRUCTIONS



Before Operating Your Dryer

Read your dryer Use and Care Guide. It has important safety and warranty information. It also has many suggestions for best drying results.

⚠ WARNING To reduce the risk of fire, electric shock or injury to persons, read the IMPORTANT SAFETY INSTRUCTIONS in your dryer Use and Care Guide before operating this appliance.

Operating Steps

Read “Drying Procedures” in your Use and Care Guide. It explains these operating steps in detail.

1. Prepare items for drying.
2. Check that lint screen is clean and in place.
3. Load the dryer. If desired, add a dryer fabric softener sheet. Close the door.
4. Press CYCLES until desired cycle is selected. Suitable drying temperature, dryness level and options will automatically be displayed. To change these settings, press TEMPS, DRYNESS and OPTIONS until the desired selections are made. Those adjustments to the cycle will automatically be remembered each time that cycle is selected.
5. To select or delete Press Saver and Air Fluff/No Heat, press OPTIONS until the flashing light indicates a desired option. Then press SELECT to add or delete the option.
6. If you wish to return to the factory settings, press and hold “CYCLES” and “OPTIONS” at the same time for 5 seconds and release. The display will show two dashes for a few seconds indicating that the factory settings have been selected.

Note: To provide the best care for your laundry items, not all temperatures, dryness levels and options are available with all cycles.

7. Add desired features by pressing symbols for
 - Control Lock
 - End-of-Cycle Signal
 - Time Dry
8. Press START to begin cycle.
 - To pause the cycle, press STOP/CLEAR once. “PAU” will flash alternately with the time remaining display. To resume the cycle, press START again.
 - To stop or clear the cycle, press STOP/CLEAR twice.
9. A signal will sound near the end of the cycle and periodically during Press Saver when the signal option is selected. When the cycle ends, remove items immediately and hang or fold.
10. Clean lint screen after every load.

Cycle Selection

For best results, follow the fabric care label instructions on items to be dried.

Auto Dry cycles take the guesswork out of drying time. The load will automatically be dried at the selected temperature to the desired dryness level. The dryer senses the moisture level of the load as it tumbles through heated air. Auto Dry cycles save time and energy and protect fabrics.

When the load has reached the selected dryness level, it will continue to tumble, unheated, during a Cool Down period. This helps reduce wrinkling and makes items easier to handle during unloading.

Drying time varies depending on size and dampness of load and fabric type. Room temperature and humidity, type of installation and electrical voltage or gas pressure can also affect drying time.

The following will be displayed during an Auto Dry cycle:

- The Estimated Drying time for the cycle selected will be displayed for approximately 5 minutes.
- The “Ad” is displayed until the Estimated Drying Time for your specific load has been determined.
- The cycle status will change from “Auto Dry” to “Cool Down” while the load is being tumbled without heat.
- “dn” is displayed when the cycle is done.
- If the Press Saver option has been selected, the load will continue to tumble without heat. The cycle status will change to “Press Saver” and “dn” will be displayed.

Normal

Select this Auto Dry cycle for cotton items.

Quick

Select this Timed Dry cycle to quickly dry a small load made up of just a few items. (Auto Dry is not available with this cycle.)

Towels

Select this Auto Dry cycle for towel loads.

Perm Press

Select this Auto Dry cycle for permanent press items.

Knits / Delicates

Select this Auto Dry cycle for knit and delicate items.

Touch Up

Select Touch Up to help remove wrinkles from clean and dry items that were not taken from the dryer at the end of the cycle, have been stored in crowded closets or drawers, or unpacked from luggage following a trip. It provides approximately 10 minutes of low heat tumbling followed by a 5-minute cool down period.

Cycle Adjustments

A suitable drying temperature and dryness level will automatically be displayed for the cycle selected. To change settings, press TEMPS and DRYNESS until the desired selections are made. These adjustments to the cycle will automatically be remembered each time that cycle is selected.

Temperature Selection

For best results, follow the fabric care label instructions on items to be dried. Select the temperature setting most suitable for each load.

! WARNING To avoid fire hazard, do not use heat to dry items containing feathers or down, foam rubber, plastics, or similarly textured, rubber-like materials. Use the Air Fluff-No Heat cycle only.

High is recommended for sturdy fabrics.

Medium is recommended for wrinkle free, permanent press and lightweight fabrics.

Medium-Low is recommended for most knits.

Low is recommended for delicate fabrics.

Note: To prevent shrinkage, every temperature is not available with every cycle.

Dryness Selection

Select **Normal Dry** for most loads.

Occasionally a load may seem too damp or over-dried at the end of the cycle. To increase drying time for similar loads in the future, select **More Dry**. For loads requiring less drying time, select **Less Dry**.

Select **Damp Dry** for items you wish to partially dry before hanging or ironing. Select the temperature most suitable for the load.

Note: To prevent over-drying, every dryness level is not available with every cycle.

Cycle Options

Press Saver

If the dried load cannot be removed promptly at the end of the cycle, unheated tumbling continues for approximately 30 minutes to help reduce wrinkling. When the signal is selected, it will beep briefly approximately every

4 minutes as a reminder to remove the load. The dried load can be removed at any time during Press Saver.

No Heat

This option provides up to 30 minutes of tumbling without heat and can only be selected in the Timed Dry cycle. Use it to dry items containing feathers or down, foam rubber, plastics or similarly textured, rubber-like materials, to freshen clothing, pillows or blankets, or to dust draperies.

Dryer Features

Control Lock

To prevent accidental operation of the dryer or alteration of the cycle settings, press and hold the lock symbol until you hear 3 beeps and "LOC" is displayed. To cancel, press and hold the lock symbol until "LOC" is no longer displayed.

Signal

A signal will sound at the end of the cycle and periodically during Press Saver. Press the signal symbol to select one of three volume levels or turn off the signal. This selection will be programmed until you change it.

Timed Dry

Use this feature to manually select the drying time for any load. Select the temperature desired. You will not be able to select a cycle or dryness level.

NOTE: Timed Dry is required when using the No Heat option.

Press TIMED DRY to select 45 minutes of drying time. The time will increase 5 minutes each time TIMED DRY is pressed. The maximum drying time is approximately 110 minutes. If you desire less than 45 minutes, you must advance beyond the 110 minute mark to start again at 15 minutes.

Error Codes

If the dryer stops and the F 01, F 02, F 03, F 04 or F 05 error code is flashing in the display, press STOP/CLEAR, select a cycle and press START. If the error code appears again, call for service to correct the problem.

- F 01 - There may be an internal problem with the control.
- F 02 - There may be a problem with the temperature

sensor.

- F 03 - There may be a problem with the heater system.
- F 04 - The dryer may have run too long. Clean the lint filter and be sure the vent is not blocked before calling for service.
- F 05 - There may be a problem with the keypad.

Dryer settings reference chart

AVAILABLE CYCLE SETTING - These temperatures, dryness levels and options available with the following cycles.

Normal	Quick**	Towels	Perm Press	Knits/Delicates	Touch Up**	Timed Dry
--------	---------	--------	------------	-----------------	------------	-----------

Temperatures

High	* X	* X	* X				X
Medium	X	X	X	* X	X		* X
Medium Low	X	X	X	X	X		X
Low	X				* X	* X	X

Dryness Level

More Dry	X		* X	X			
Normal Dry	* X		X	* X	X		
Less Dry	X		X	X	* X		
Damp Dry	X			X	X		

Options

Press Saver	* X	X	X	* X	* X	* X	X
Air Fluff- No Heat							X

* Factory setting

** Timed Dry cycle only

SECTION B - OWNERS GUIDE

⚠ WARNING For your safety, the information in this manual must be followed to minimize the risk of fire or explosion or to prevent property damage, personal injury or loss of life.

- Do not store or use gasoline or other flammable vapors and liquids in the vicinity of this or any other appliance.

- **WHAT TO DO IF YOU SMELL GAS:**

- Do not try to light any appliance.
- Do not touch any electrical switch; do not use any phone in your building.
- Clear the room, building or area of all occupants.
- Immediately call your gas supplier from a neighbor's phone. Follow the gas supplier's instructions.
- If you cannot reach your gas supplier, call the fire department.

Installation and service must be performed by a qualified installer, service agency or the gas supplier.

Your safety and the safety of others is very important.

We have provided many important safety messages in the Use and Care Guide, Operating Instructions, Installation Instructions and on your appliance. Always read and obey all safety messages.

⚠ This is the safety alert symbol. This symbol alerts you to hazards that can kill or hurt you or others. All safety messages will be preceded by the safety alert symbol and the word "DANGER" or "WARNING". These words mean:

⚠ DANGER You will be killed or seriously injured if you don't follow instructions.

⚠ WARNING You can be killed or seriously injured if you don't follow instructions.

All safety messages will identify the hazard, tell you how to reduce the chance of injury, and tell you what can happen if the instructions are not followed.

Pedestal

A pedestal accessory specifically designed for this dryer may be used when elevating the dryer for ease of use.

Failure to use accessories certified by the manufacturer could result in personal injury, property damage or damage to the dryer.

Important Safety Instructions

Read all instructions before using this dryer.

⚠ WARNING To reduce the risk of fire, electrical shock, or injury to persons when using this dryer, comply with the basic warnings listed below.

⚠ Failure to comply with these warnings could result in serious personal injuries.

Prevent Fire

⚠ WARNING Do not dry items that have been previously cleaned in, soaked in, or spotted with gasoline, cleaning solvents, kerosene, waxes, etc. Do not store these items on or near the dryer. These substances give off vapors that could ignite or explode.

⚠ WARNING To prevent fire, do not use heat to dry items containing plastic, foam rubber or similarly textured rubber-like materials, or items containing feathers or down. Use Air Fluff (No Heat) only.

⚠ WARNING Clean the lint screen before or after each load. The interior of the dryer, lint screen housing and exhaust duct should be cleaned approximately every 18 months by qualified service personnel. An excessive amount of lint build-up in these areas could result in inefficient drying and possible fire. See **Care and Cleaning**.

⚠ WARNING Do not operate the dryer if the lint screen is blocked, damaged or missing. Fire hazard, overheating and damage to fabrics can occur. If your

dryer has a drying rack, always replace the lint screen when finished using the drying rack.

⚠ WARNING Keep area around the exhaust opening and surrounding areas free from the accumulation of lint, dust and dirt.

⚠ WARNING Do not obstruct the flow of ventilating air. Do not stack or place laundry or throw rugs against the front or back of the dryer.

⚠ WARNING Do not spray any type of aerosol into, on or near dryer at any time.

⚠ WARNING Do not use fabric softeners or products to eliminate static unless recommended by the manufacturer of the fabric softener or product.

⚠ Failure to comply with these warnings could result in fire, explosion, serious bodily injury and/or damage to the rubber or plastic parts of the dryer.

This Use and Care Guide provides general operating instructions for your dryer. It also contains information about features for several other models. Your dryer may not have every feature included.

Use the dryer only as instructed in this Use & Care Guide and the **Operating Instructions** card included with your dryer.

⚠ WARNING Avoid fire hazard or electrical shock. Do not use an adaptor plug or extension cord or remove grounding prong from electrical power cord. Failure to follow this warning can cause serious injury, fire or death.

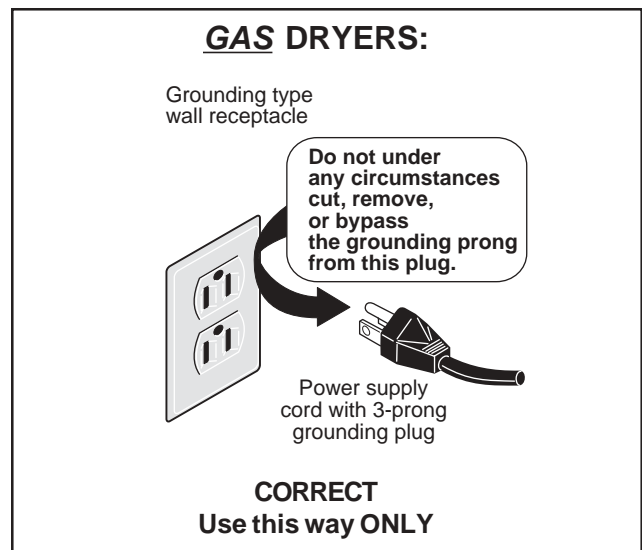
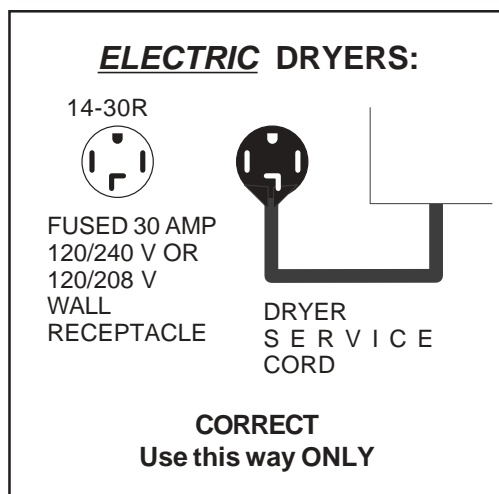

Note: The instructions appearing in this Owner's Guide are not meant to cover every possible condition and situation that may occur. Common sense and caution must be practiced when installing, operating and maintaining any appliance.

Protect Children

⚠ WARNING Do not allow children to play on or in the dryer. Close supervision of children is necessary when the dryer is used near children. As children grow, teach them the proper, safe use of all appliances.

⚠ WARNING Destroy the carton, plastic bag and other packing materials after the dryer is unpacked. Children might use them for play. Cartons covered with rugs, bedspreads or plastic sheets can become airtight chambers.

⚠ WARNING Keep laundry products out of children's reach. To prevent personal injury, observe all warnings on product labels.

⚠ WARNING Before the dryer is removed from service or discarded, remove the dryer door to prevent accidental entrapment.

⚠ Failure to comply with these warnings could result in serious personal injuries.

Prevent Injury

⚠ WARNING To prevent shock hazard and assure stability during operation, the dryer must be installed and electrically grounded by a qualified service person in accordance with local codes. Installation instructions are packed in the dryer for the installer's reference. Refer to

INSTALLATION INSTRUCTIONS for detailed grounding procedures. If the dryer is moved to a new location, have it checked and reinstalled by a qualified service person.

⚠ WARNING To prevent personal injury or damage to the dryer, the electrical power cord of a gas dryer must be plugged into a properly grounded and polarized 3-prong outlet. **The third grounding prong must never be removed. Never ground the dryer to a gas pipe. Do not use an extension cord or an adaptor plug.**

⚠ WARNING **ALWAYS disconnect** the dryer from the electrical supply before attempting any service or cleaning. Failure to do so can result in electrical shock or injury.

⚠ WARNING Do not use any type spray cleanser when cleaning dryer interior. Hazardous fumes or electrical shock could occur.

⚠ WARNING To prevent injury, do not reach into the dryer if the drum is moving. Wait until the dryer has stopped completely before reaching into the drum.

⚠ WARNING To prevent injury and damage to the dryer:

- **All repairs and servicing must be performed by an authorized servicer** unless specifically recommended in this Owner's Guide. Use only authorized factory parts.
- **Do not** tamper with controls.
- **Do not** install or store the dryer where it will be exposed to the weather.

⚠ A thermal limiter switch automatically turns off the motor in the unlikely event of an overheated situation (electric dryers only). A service technician must replace the thermal limiter switch after correcting the fault.

⚠ Failure to comply with these warnings could result in serious personal injuries.

SAVE THESE INSTRUCTIONS

Drying Procedures

- Follow the guidelines below for preparing the load for drying.
- Read the **Operating Instructions** card for operating your specific model.

- **Always read and follow fabric care labels and laundry product labels.**

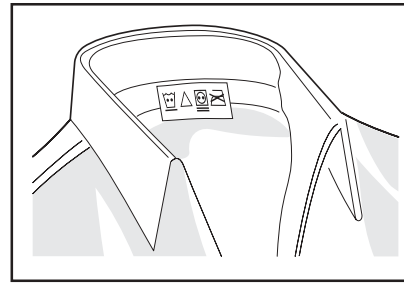

⚠ WARNING To reduce the risk of fire, electrical shock, or injury to persons, read **Important Safety Instructions** before operating this dryer.

1. Prepare items for drying.

- Dry items of similar fabric, weight and construction in the same load.
- Separate dark items from light-colored items. Separate items that shed lint from those that attract lint. If an item sheds lint, turn it inside out.
- Be sure buckles, buttons and trim are heatproof and won't damage the drum finish. Close zippers, fasten hooks and Velcro®-like fasteners. Tie strings and sashes to prevent snagging and tangling.
- If possible, turn pockets inside out for even drying.
- Check for stains which may not have been removed in washing. Dryer heat may permanently set some stains. Repeat stain removal process before drying.
- Place small items in a mesh bag to prevent tangling and for easy removal.

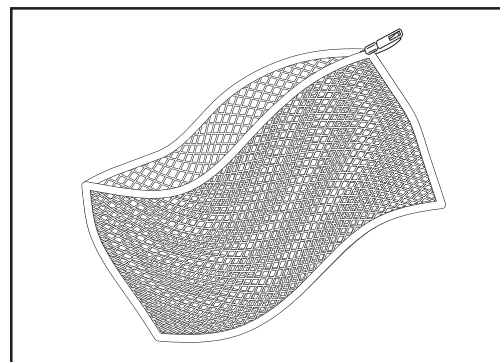

2. Check that lint screen is clean and in place.

3. Load the dryer.

- The average load will fill the drum 1/3 to 1/2 full. Items need room to tumble freely for even drying and less wrinkling. **Do not overload dryer.**

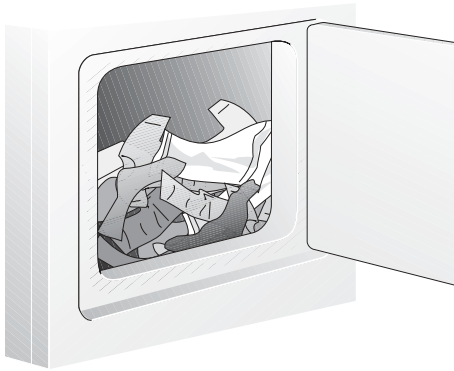

- When drying large items, dry only 2 or 3 at a time. Fill out the load with small and medium sized items.
- For delicate or very small loads, add 2 lint-free towels for better drying, less wrinkling, and to prevent grease stains caused by fabric softener sheets.
- Do not overdry items. Overdrying can cause wrinkling, shrinkage, harshness, and a build-up of static electricity, which can produce more lint.
- If desired, add a dryer fabric softener sheet.

4. Close the dryer door and set dryer controls (some models).

See **Operating Instructions** card for your specific model information.

5. Start the dryer.

- Press START.
- To change selections after the cycle has started, press STOP/CLEAR twice. Make changes and restart dryer.
- To add or remove items when the dryer is running, press STOP/CLEAR once to pause the dryer. "PAU" will be displayed. The dryer will always stop when the door is opened. Allow the drum to come to a complete stop before reaching inside.

- To resume the cycle, press START again.
- To stop the dryer, press STOP/CLEAR twice. Two dashes will be displayed for approximately thirty seconds.

6. When the cycle ends, remove items immediately and hang or fold. If load is removed before the cycle ends, press STOP/CLEAR twice to cancel the cycle.

Features

End of Cycle Signal

A signal will sound at the end of the cycle and periodically during Press Saver at the volume level selected. (some models)

Drum Light (some models)

A drum light will come on whenever the door is opened to illuminate the dryer drum during loading and unloading. Closing the door turns off the light.

Reversible Dryer Door

Your dryer is equipped with a reversible door. The door can be hinged on the right or left side. Refer to the **INSTALLATION INSTRUCTIONS** for directions on changing the door.

Drying Rack (some models)

Use the drying rack to dry items which should not be tumble dried.

1. Open the dryer door and remove the lint screen.
2. Insert drying rack into the dryer drum. Place the front bar under the lip of the lint screen opening.

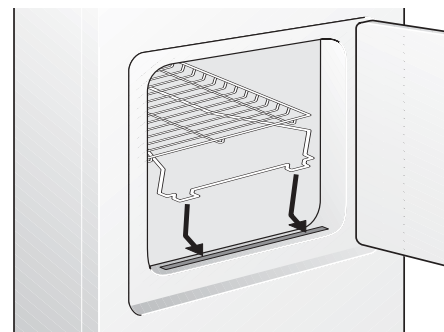

3. Place items to be dried on top of the rack. Weight should not exceed 10 lbs. Leave space between items, but do not let items hang over the sides or

- through the grids. Do not tumble other items when using the drying rack.
4. Select a timed dry. Use only the Air Fluff (no heat) temperature setting for items containing plastic, foam rubber, rubber-like materials, feathers or down.
 5. When items are dry, remove the rack and replace the lint screen. If lint screen is not in place, tumbling items could enter the exhaust system and cause damage to the dryer.

Common Drying Problems

Many drying problems involve poor cleaning results, poor soil and stain removal, residues of lint and scum, and fabric damage. For satisfactory drying results, follow these suggestions provided by The Soap and Detergent Association.

PROBLEM	POSSIBLE CAUSES	SOLUTIONS	PREVENTIVE MEASURES
Greasy, oily stains	<ul style="list-style-type: none"> • Fabric softener sheet. 	<ul style="list-style-type: none"> • Rub fabric softener stains with bar soap. Rinse and rewash. 	<ul style="list-style-type: none"> • Add a few bath towels to small loads for proper tumbling. • Some "silk-like" fabrics should be air dried. • Use proper drying temperature. • Place fabric softener sheet on top of load before starting the dryer.
Lint	<ul style="list-style-type: none"> • Overloading. • Overdrying causes static electricity. • Lint screen not clean when cycle began. • Lint is attached to "pills." 	<ul style="list-style-type: none"> • Reduce load size and rewash using liquid fabric softener in the final rinse. • Or, add a fabric softener sheet and tumble without heat. • Use lint brush or roller to remove lint. 	<ul style="list-style-type: none"> • Do not overload dryer. • Use fabric softener in washer or dryer to reduce static electricity. • Remove items when they are slightly damp to avoid overdrying. • Check that lint screen is clean and in place.
Pilling (Fibers break off, ball up and cling to fabric.)	<ul style="list-style-type: none"> • Pilling is normal with synthetic and permanent press fabrics. This is due to abrasion from normal wear. 	<ul style="list-style-type: none"> • Use a lint brush or shaver to remove pills. 	<ul style="list-style-type: none"> • Use fabric softener to lubricate fibers. • When ironing, use spray starch or fabric finish on collars and cuffs. • Turn items inside out to reduce abrasion.
Shrinking	<ul style="list-style-type: none"> • Overdrying. 	<ul style="list-style-type: none"> • Irreversible condition. 	<ul style="list-style-type: none"> • Follow fabric care label directions. • If shrinking is a concern, check load often. • Remove items while slightly damp and hang or lay flat to complete drying. • Block knits into shape.
Wrinkling	<ul style="list-style-type: none"> • Overloading. • Leaving items in dryer after cycle ends. 	<ul style="list-style-type: none"> • Reduce load size and tumble at medium or low heat for 5-10 minutes. • Remove items immediately. Hang or fold. 	<ul style="list-style-type: none"> • Do not overload dryer. • Remove items as soon as cycle ends.

Care and Cleaning

⚠ WARNING To reduce risk of fire or serious injury to persons or property, comply with the basic warnings listed in **Important Safety Instructions** and those listed below.

- Before cleaning the dryer interior, **unplug the electrical power cord** to avoid electrical shock hazards.
- Do not use any type spray cleanser when cleaning dryer interior. Hazardous fumes or electrical shock could occur.

Inside

- Clean the lint screen after every load. Lint build-up in the screen restricts air flow, which causes longer drying times. The screen is located at the bottom of the door opening. Remove by pulling straight up. Remove the lint and replace the screen.

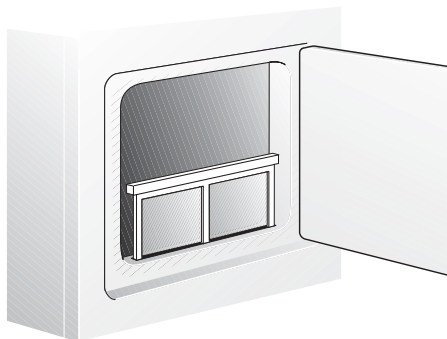

- Occasionally a waxy build-up may form on the lint screen from using dryer-added fabric softener sheets. To remove this build-up, wash the lint screen in warm, soapy water. Dry thoroughly and replace. Do not operate the dryer without the lint screen in place.
- If the dryer drum becomes stained from noncolorfast fabrics, clean the drum with a damp cloth and a mild liquid household cleanser. Remove cleanser residue before drying the next load.
- Every 18 months an authorized servicer should clean the dryer cabinet interior and exhaust duct. These areas can collect lint and dust over time. An excessive amount of lint build-up could result in inefficient drying and possible fire hazard.

Outside

- Clean the cabinet with mild soap and water. **Never use harsh, gritty or abrasive cleansers.**
- If the cabinet becomes stained, clean with diluted chlorine bleach [1/2 cup (120 ml) in 1 quart (.95 liter) water]. Rinse several times with clear water.
- Remove glue residue from tape or labels with a mixture of warm water and mild detergent. Or, touch residue with the sticky side of the tape or label.
- **Before moving the dryer**, place a strip of cardboard or thin fiberboard under the front leveling legs to prevent damage to floor.



Do not store or place laundry products on top of dryer at any time. They can damage the finish or controls.

Avoid Service Checklist

Before calling for service, review this list. It may save both time and expense. The list includes common occurrences that are not the result of defective workmanship or materials in this dryer.

OCCURRENCE	POSSIBLE CAUSE	SOLUTION
Dryer does not start.	Electrical power cord is not securely plugged in or plug may be loose.	Make sure the plug fits tightly in wall outlet.
	House fuse blown or circuit breaker tripped.	Reset circuit breaker or replace fuse. Make sure electrical line is not overloaded and the dryer is on a separate circuit.
	Thermal limiter tripped.	Call authorized service person for replacement.
Dryer runs but won't heat.	There are 2 house fuses in the dryer circuit. If 1 of the 2 fuses is blown, the drum may turn but the heater will not operate.	Replace fuse.
	Gas supply valve is not open (gas models).	Check to make sure supply valve is open. See INSTALLATION INSTRUCTIONS for procedure.
	Dryer does not have enough air supply to support the burner flame (gas models).	See INSTALLATION INSTRUCTIONS.
	LP gas supply tank is empty or there has been a utility interruption of natural gas (gas models).	Refill or replace tank. Dryer should heat when utility service is restored.
Drying cycle takes too long, outside of the dryer feels too hot or smells hot.	Lint screen is clogged with lint.	Make sure all lint has been removed from the dryer lint screen before starting each cycle.
	Exhaust duct requirements have not been met.	Exhaust duct must be at least 4 inches in diameter and made of rigid or flexible metal. When in place, the duct must have no more than two 90° bends and must not exceed length listed in INSTALLATION INSTRUCTIONS.
	Electric dryer is connected to a 208 volt circuit.	Drying time will be 20% longer than drying on a 240 volt circuit.
	Drying procedures have not been followed.	See Drying Procedures .
	Outside exhaust hood or exhaust duct may be clogged or restricted.	Clean out any obstruction.
High humidity.	Use a dehumidifier near the dryer.	
Excessive wrinkling.	Dryer is overloaded.	Do not overload. See Drying Procedures .
	Items left in dryer too long.	Remove items as soon as cycle ends.
	Insufficient sorting of items.	See Drying Procedures .
	Drying temperature too high.	Follow fabric care label instructions.

Avoid Service Checklist

Before calling for service, review this list. It may save both time and expense. The list includes common occurrences that are not the result of defective workmanship or materials in this dryer.

OCCURRENCE	POSSIBLE CAUSE	SOLUTION
Scratching or chipping of the drum finish.	Foreign objects such as coins, pins, clips or buttons are inside the dryer. Permanently attached items such as belt buckles, zippers and fasteners may be hitting the inside of the drum.	Always remove foreign objects from pockets before laundering. Remove objects from drum and restart dryer. It may be necessary to baste a scrap of material securely around ornaments before drying to prevent scratching and damage to the dryer. Drum damage caused by foreign objects or permanently attached items is not covered by the warranty.

FRIGIDAIRE DRYER WARRANTY

Your Frigidaire product is protected by this warranty

Sample warranty - always check warranty with product

	WARRANTY PERIOD	FRIGIDAIRE, THROUGH ITS AUTHORIZED SERVICERS, WILL:	THE CONSUMER WILL BE RESPONSIBLE FOR:
FULL ONE-YEAR WARRANTY	One year from original purchase date.	Pay all costs for repairing or replacing any parts of this appliance which prove to be defective in materials or workmanship.	Costs of service calls that are listed under IMPORTANT RESPONSIBILITIES OF THE CONSUMER.*
LIMITED WARRANTY (Applicable to the State of Alaska)	Time period listed above.	All of the provisions of the full warranty above and the exclusions listed below apply.	Costs of the technician's travel to the home and any costs for pick up and delivery of the appliance required because of service.

Your appliance is warranted by Frigidaire Home Products, a division of White Consolidated Industries, Inc. We authorize no person to change or add to any of our obligations under this warranty. Our obligations for service and parts under this warranty must be performed by Frigidaire or an authorized Frigidaire servicer.

This warranty applies only to products in ordinary household use, and the consumer is responsible for the items listed below:

1. Proper use of the appliance in accordance with instructions provided with the product.
2. Proper installation by an authorized servicer in accordance with instructions provided with the appliance and in accordance with all local plumbing, electrical and/or gas codes.
3. Proper connection to a grounded power supply of sufficient voltage, replacement of blown fuses, repair of loose connections or defects in house wiring.
4. Expenses for making the appliance accessible for servicing, such as removal of trim, cupboards, shelves, etc., which are not a part of the appliance when it was shipped from the factory.
5. Damages to finish after installation.
6. Replacement of light bulbs and/or fluorescent tubes (on models with these features).

This warranty does not cover the following:

1. CONSEQUENTIAL OR INCIDENTAL DAMAGES SUCH AS PROPERTY DAMAGE AND INCIDENTAL EXPENSES RESULTING FROM ANY BREACH OF THIS WRITTEN OR ANY IMPLIED WARRANTY.
Note: Some states do not allow the exclusion or limitation of incidental or consequential damages, so this limitation or exclusion may not apply to you.
2. Service calls which do not involve malfunction or defects in workmanship or material, or for appliances not in ordinary household use. The consumer shall pay for such service calls.
3. Damages caused by services performed by servicers other than Frigidaire or its authorized servicers; use of parts other than genuine Frigidaire Home Products parts; obtained from persons other than such servicers; or external causes such as abuse, misuse, inadequate power supply or acts of God.
4. Products with original serial numbers that have been removed or altered and cannot be readily determined.

Keep your bill of sale, delivery slip, or some other appropriate payment record. The date on the bill establishes the warranty period should service be required. If service is performed, it is in your best interest to obtain and keep all receipts. This written warranty gives you specific legal rights. You may also have other rights that vary from state to state. Service under this warranty must be obtained by contacting Frigidaire Home Products:

800 • 944 • 9044
 Frigidaire Home Products
 P.O. Box 212378
 Augusta, GA 30917



Product features or specifications as described or illustrated are subject to change without notice. All warranties are made by White Consolidated Industries, Inc. This warranty applies only in the 50 states of the U.S.A. and Puerto Rico.

SECTION C - INSTALLATION INSTRUCTIONS GAS & ELECTRIC DRYER

Before beginning installation, carefully read these instructions. This will simplify the installation and ensure the dryer is installed correctly and safely. Leave these instructions near the Dryer after installation for future reference.

NOTE: The electrical service to the Dryer must conform with local codes and ordinances and the latest edition of the National Electrical Code, ANSI/NFPA 70.

NOTE: The gas service to the Dryer must conform with local codes and ordinances and the latest edition of the National Fuel Gas Code ANSI Z223.1.

NOTE: The Dryer is designed under ANSI Z 21.5.1 or ANSI/UL 2158 - CAN/CSA C22.2 (latest editions) for HOME USE only. This Dryer is not recommended for commercial applications such as restaurants **or beauty salons, etc.**

⚠ WARNING For your safety the information in this manual must be followed to minimize the risk of fire or explosion or to prevent property damage, personal injury or loss of life.

- Do not store or use gasoline or other flammable vapors and liquid in the vicinity of this or any other appliance.
- **WHAT TO DO IF YOU SMELL GAS**
 - Do not try to light any appliance.
 - Do not touch any electrical switch; do not use any phone in your building.
 - Clear the room, building or area of all occupants.
 - Immediately call your gas supplier from a neighbor's phone. Follow the gas supplier's instructions.
 - If you cannot reach your gas supplier, call the fire department.

Installation and service must be performed by a qualified installer, service agency or the gas supplier.

PRE-INSTALLATION REQUIREMENTS

Tools and Materials Required for Installation:

1. Phillips head screwdriver.
2. Channel-lock adjustable pliers.
3. Carpenter's level.
4. Flat or straight blade screwdriver.
5. Duct tape.
6. Rigid or flexible metal 4 inch (10.2 cm) duct.
7. Vent hood.
8. Pipe thread sealer (Gas).
9. Plastic knife

ELECTRICAL REQUIREMENTS

ELECTRIC Dryer

CIRCUIT - Individual 30 amp. branch circuit fused with 30 amp. minimum time delay fuses or circuit breakers.

POWER SUPPLY - 3 or 4 wire, 240 volt, single phase, 60 Hz, Alternating Current.

POWER SUPPLY CORD KIT - The dryer **MUST** employ a 3-conductor power supply cord NEMA 10-30 type SRDT rated at 240 volt AC minimum, 30 amp., with 3 open end spade lug connectors with upturned ends or closed loop connectors or a 4-conductor power supply cord NEMA 14-30 type SRDT or ST (as required) rated at 240 volt AC minimum, 30 amp., with 4 open end spade lug connectors with upturned ends or closed loop connectors and marked for use with clothes dryers. If being installed in a **manufactured (mobile) home**, the dryer **must** employ a 4-conductor power supply cord NEMA 14-30 type SRDT or ST (as required) rated at 240 volt AC minimum, 30 amp., with 4 open end spade lug connectors with upturned ends or closed loop connectors and marked for use with clothes dryers. See ELECTRICAL CONNECTIONS FOR for additional instructions

OUTLET RECEPTACLE - NEMA 10-30R (3wire) receptacle or NEMA 14-30R (4wire) receptacle to be located so the power supply cord is accessible when the dryer is in the installed position.



NEMA 10-30R

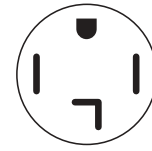

NEMA 14-30R

GAS Dryer

CIRCUIT - Individual 15 amp. branch circuit fused with a 15 amp. maximum time delay fuse or circuit breaker.

POWER SUPPLY - 3 wire, 120 volt single phase, 60 Hz, Alternating Current.

POWER SUPPLY CORD - The dryer is equipped with a 120 volt 3-wire power cord.

NOTE: Do not under any circumstances remove grounding prong from plug.

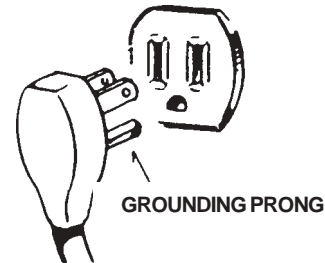

EXHAUST SYSTEM REQUIREMENTS

Use only 4 inch (10.2 cm) diameter (minimum) rigid or flexible metal duct and approved vent hood which has a swing-out damper(s) that open when the dryer is in operation. When the dryer stops, the dampers automatically close to prevent drafts and the entrance of insects and rodents. To avoid restricting the outlet, maintain a minimum of 12 inches (30.5 cm) clearance between the vent hood and the ground or any other obstruction.

⚠ WARNING The following are specific requirements for proper and safe operation of your dryer. Failure to follow these instructions can create excessive drying times and fire hazards.

⚠ Do not use plastic flexible duct to exhaust the dryer. Excessive lint can build up inside exhaust system and create a fire hazard and restrict air flow. Restricted air flow will increase dryer times. If your present system is made up of plastic duct or metal foil duct, **replace it** with a rigid or flexible metal duct. **Ensure the present duct is free of any lint prior to installing dryer duct.**

⚠ If the dryer is not exhausted outdoors, some fine lint will be expelled into the laundry area. An accumulation of lint in any area of the home can create a health and fire hazard. **The dryer exhaust system MUST be exhausted to the outside of the dwelling!**

⚠ Do not allow combustible materials (for example: clothing, draperies/curtains, paper) to come in contact with exhaust system. The dryer **MUST NOT** be exhausted into a chimney, a wall, a ceiling, or any concealed space of a building which can accumulate lint, resulting in a fire hazard.

⚠ Exceeding the length of duct pipe or number of elbows allowed in the "MAXIMUM LENGTH" charts can cause an accumulation of lint in the exhaust system. Plugging the system could create a fire hazard, as well as increase drying times.

⚠ Do not screen the exhaust ends of the vent system, nor use any screws or rivets to assemble the exhaust system. Lint can become caught in the screen, on the screws or rivets, clogging the duct work and creating a fire hazard as well as increasing drying times. Use an approved vent hood to terminate the duct outdoors, and seal all joints with duct tape. All male duct pipe fittings **MUST** be installed downstream with the flow of air.

⚠ WARNING Explosion hazard. Do not install the dryer where gasoline or other flammables are kept or stored. If the dryer is installed in a garage, it must be a minimum of 18 inches (45.7 cm) above the floor. Failure to do so can result in death, explosion, fire or burns.

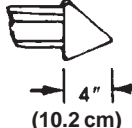
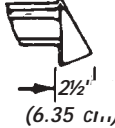
MAXIMUM LENGTH of 4" (10.2 cm) Dia. Flexible Metal Duct			
VENT HOOD TYPE (Preferred)			
Number of 90° Turns		Louvered	
	4" (10.2 cm)		2 1/2" (6.35 cm)
0	30 ft. (9.14 m)		18 ft. (5.49 m)
1	22 ft. (6.71 m)		14 ft. (4.27 m)
2	14 ft. (4.27 m)		10 ft. (3.05 m)
3	NOT RECOMMENDED		

In installations where the exhaust system is not described in the charts, the following method must be used to determine if the exhaust system is acceptable:

1. Connect an inclined or digital manometer between the dryer and the point the exhaust connects to the dryer.
2. Set the dryer timer and temperature to air fluff (cool down) and start the dryer.
3. Read the measurement on the manometer.
4. The system back pressure **MUST NOT** be higher than 0.75 inches of water column. If the system back pressure is less than 0.75 inches of water column, the system is acceptable. If the manometer reading is higher than 0.75 inches of water column, the system is too restrictive and the installation is unacceptable.

Although vertical orientation of the exhaust system is acceptable, certain extenuating circumstances could affect the performance of the dryer:

- Only the rigid metal duct work should be used.
- Venting vertical through a roof may expose the exhaust system to down drafts causing an increase in vent restriction.
- Running the exhaust system through an uninsulated area may cause condensation and faster accumulation of lint.
- Compression or crimping of the exhaust system will cause an increase in vent restriction.

The exhaust system should be inspected and cleaned a minimum of **every 18 months** with normal usage. The more the dryer is used, the more often you should check the exhaust system and vent hood for proper operation.

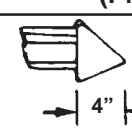
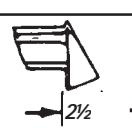
MAXIMUM LENGTH of 4" (10.2 cm) Dia. Rigid Metal Duct			
VENT HOOD TYPE (Preferred)			
Number of 90° Turns		Louvered	
	4" (10.2 cm)		2 1/2" (6.35 cm)
0	60 ft. (18.28 m)		48 ft. (14.63 m)
1	52 ft. (15.84 m)		40 ft. (12.19 m)
2	44 ft. (13.41 m)		32 ft. (9.75 m)
3	32 ft. (9.75 m)		24 ft. (7.31 m)
4	28 ft. (8.53 m)		16 ft. (4.87 m)

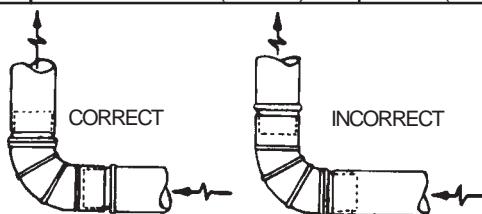

INSTALL MALE FITTINGS IN CORRECT DIRECTION

EXHAUST DIRECTION

All dryers shipped from the factory are set up for rear exhausting. However, on electric dryers, exhausting can be to the right or left side of the cabinet or the bottom of the dryer. On gas dryers, exhausting can be to the right side of the cabinet or the bottom of the dryer. Directional exhausting can be accomplished by installing Exhaust Kit, P/N 131456800, available through your parts distributor. Follow the instructions supplied with the kit.

EXHAUST DUCT LOCATING DIMENSIONS

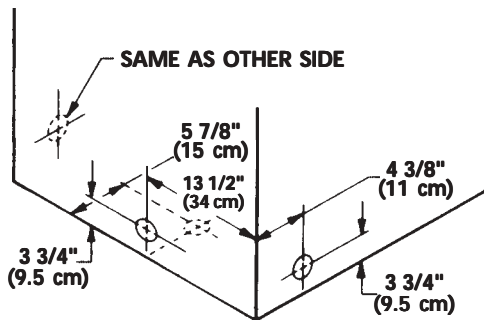

GAS SUPPLY REQUIREMENTS

! WARNING Replace copper connecting pipe that is not plastic-coated. Stainless steel or plastic-coated brass **MUST** be used.

1. Installation **MUST** conform with local codes, or in the absence of local codes, with the National Fuel Gas Code, ANSI Z223.1 (latest edition)
2. The gas supply line should be of 1/2 inch (1.27 cm) pipe.
3. If codes allow, flexible metal tubing may be used to connect your dryer to the gas supply line. The tubing **MUST** be constructed of stainless steel or plastic-coated brass.
4. The gas supply line **MUST** have an individual shutoff valve.
5. A 1/8 inch (0.32 cm) N.P.T. plugged tapping, accessible for test gauge connection, **MUST** be installed immediately upstream of the gas supply connection to the dryer.
6. The dryer **MUST** be disconnected from the gas supply piping system during any pressure testing of the gas supply piping system at test pressures in excess of 1/2 psig (3.45 kPa).

7. The dryer **MUST** be isolated from the gas supply piping system during any pressure testing of the gas supply piping system at test pressures equal to or less than 1/2 psig (3.45 kPa).

LOCATION OF YOUR DRYER

DO NOT INSTALL YOUR DRYER:

1. In an area exposed to dripping water or outside weather conditions.
2. In an area where it will come in contact with curtains, drapes, or anything that will obstruct the flow of combustion and ventilation air.
3. On carpet. Floor **MUST** be solid with a maximum slope of 1 inch (2.54 cm).

INSTALLATION IN RECESS OR CLOSET

1. A dryer installed in a bedroom, bathroom, recess or closet, **MUST** be exhausted outdoors.
2. No other fuel burning appliance shall be installed in the same closet as the Gas dryer.
3. Your dryer needs the space around it for proper ventilation.

DO NOT INSTALL YOUR DRYER IN A CLOSET WITH A SOLID DOOR.

4. A minimum of 120 square inches (774.2 square cm) of opening, equally divided at the top and bottom of the door, is required. Air openings are required to be unobstructed when a door is installed. A louvered door with equivalent air openings for the full length of the door is acceptable.

MINIMUM INSTALLATION CLEARANCES (Inches)

	SIDES	REAR	TOP	FRONT
Alcove	0 (0 cm)	0 (0 cm)	15 (38.1 cm)	
Closet	0 (0 cm)	0 (0 cm)	15 (38.1 cm)	1 (2.54 cm)

Closet door ventilation required: 2 louvered openings each 60 square inches (387 square centimeters) — 3 inches (7.6 cm) from bottom and top of door.

NOTE: Under counter and stack models - 0 inches (0 cm) for sides, rear, and top.

THIS DRYER MUST BE EXHAUSTED OUTDOORS.

5. The following illustrations show minimum clearance dimensions for proper operation in a recess or closet installation.

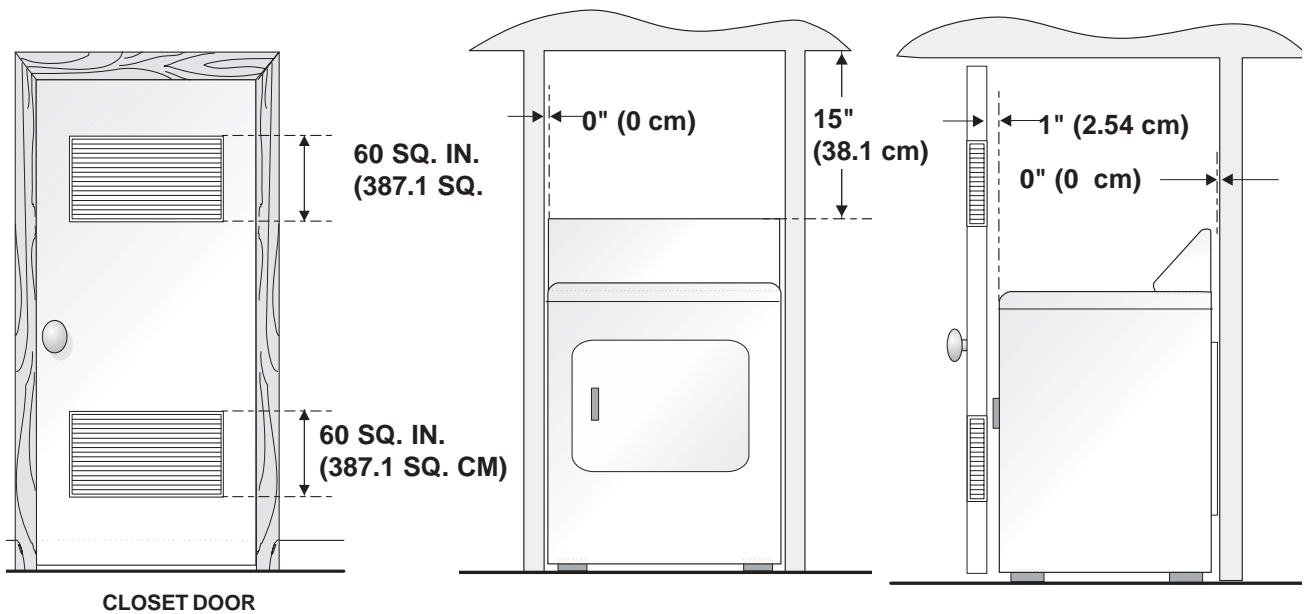

NOTE: Under counter and stack models - 0 inches (0 cm) for sides, rear, and top.

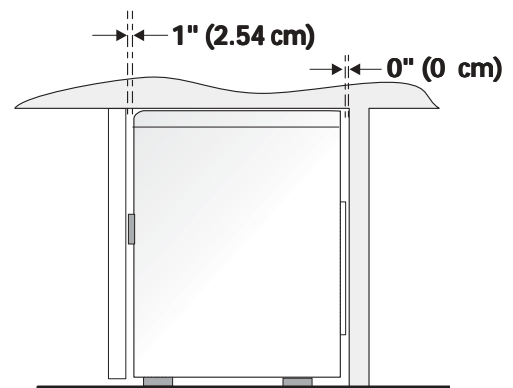
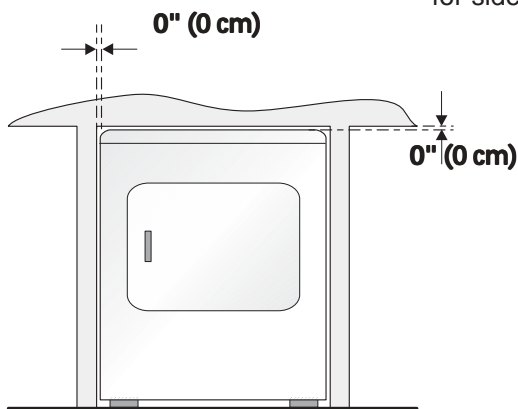

MOBILE HOME INSTALLATION

1. Dryer **MUST** be exhausted outside (outdoors, not beneath the mobile home) using metal ducting that will not support combustion. Metal ducting must be 4 inches (10.16 cm) in diameter with no obstructions. Rigid metal duct is preferred.
2. If dryer is exhausted through the floor and area beneath the mobile home is enclosed, the exhaust system **MUST** terminate outside the enclosure with the termination securely fastened to the mobile home structure.
3. When installing a gas dryer into a mobile home, a provision must be made for outside make up air. This provision is to be not less than twice the area of the dryer exhaust outlet.
4. This dryer **MUST** be fastened to the floor. Mobile Home Installation Kit No. 346764 is available from your dealer.
5. Refer to pages 27 and 28 for other important venting requirements.
6. Installation **MUST** conform to current Manufactured Home Construction & Safety Standard (which is a Federal Regulation Title 24 CFR-Part 32-80) or when such standard is not applicable, with American National Standard for Mobile Homes.

⚠ WARNING The dryer is designed under ANSI Z 21.5.1 or ANSI/UL2158 - CAN/CSA C22.2 (latest editions) for **HOME USE** only.

**UNDER COUNTER & STACK MODELS
ROUGH-IN DIMENSIONS**

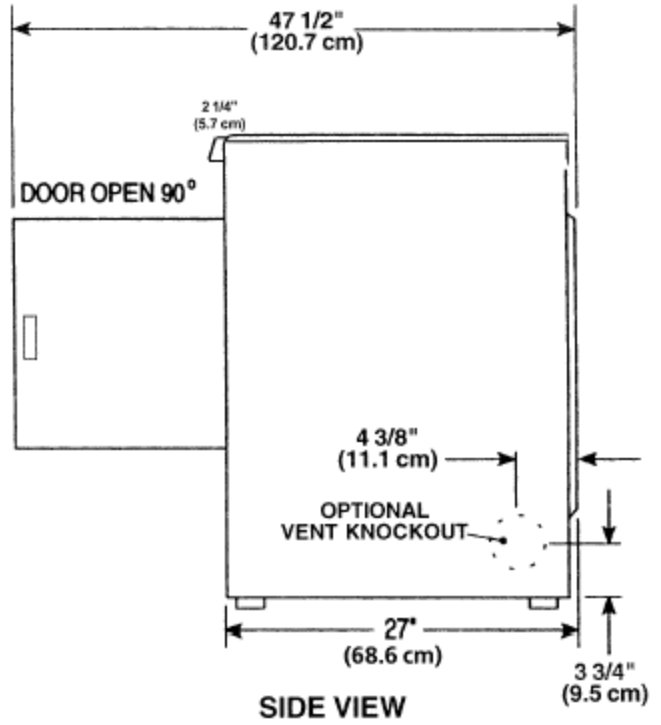
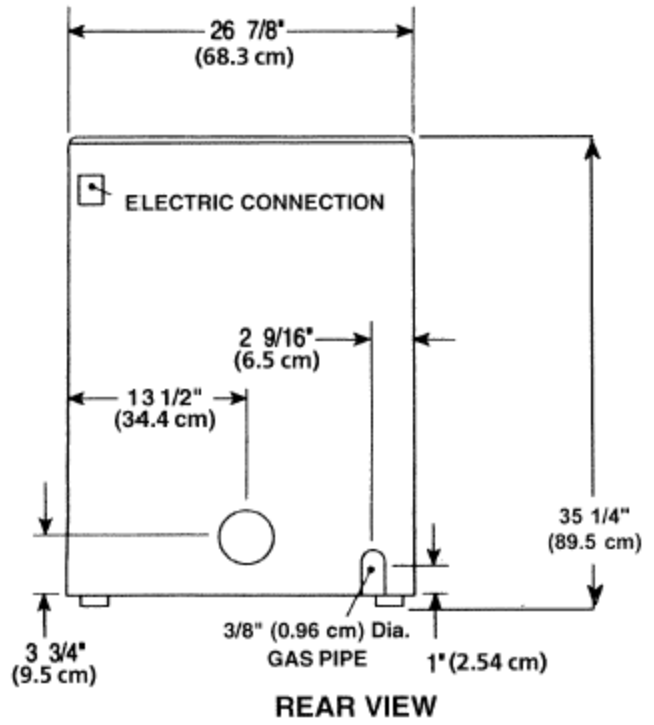
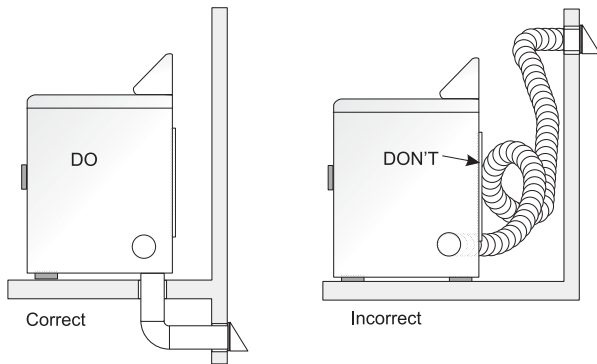
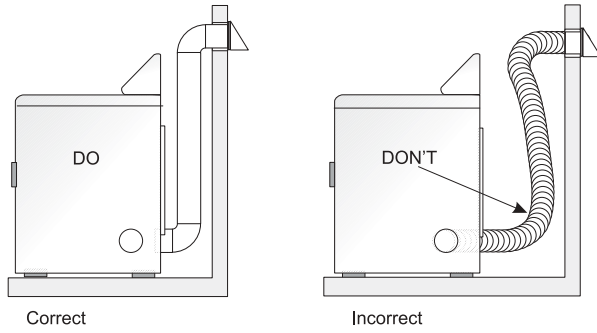
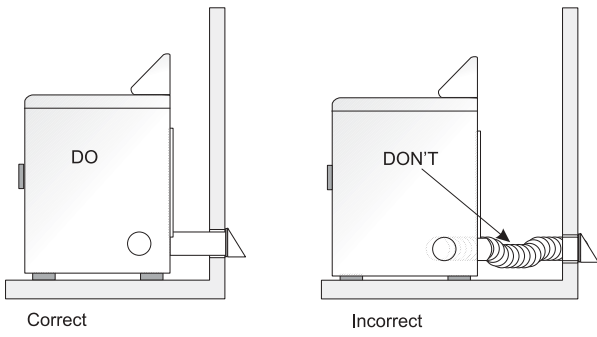

UNPACKING

1. Using the four shipping carton corner posts (two on each side), carefully lay the dryer on its left side and remove foam shipping base.

⚠ CAUTION To prevent damage, do not use the control panel as a means to pick up or move the dryer.

2. Return the dryer to an upright position.

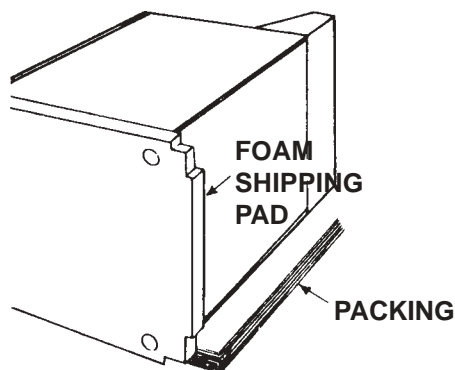

REVERSING DOOR SWING

Your dryer is designed so the door swing may be reversed at any time without additional parts. Conversion is accomplished by transferring hinges to the opposite side of the cabinet.

To change the direction of the door opening:

1. Open the dryer door. Remove the four hinge hole plugs from the left side of the door opening. Place nearby for future installation. **NOTE:** You may need a plastic knife to help pull out the plugs. Be careful not to scratch the paint.
2. Remove the four screws that secure the door hinges to the dryer front panel. **NOTE:** Remove one screw from each of the two hinges first. Hold the door firmly before removing the last two screws.
3. Rotate the door 180° and reinstall the door hinges to the dryer front panel with the four screws.
4. Install the four hinge hole plugs in the open screw holes on the right side of the door opening.

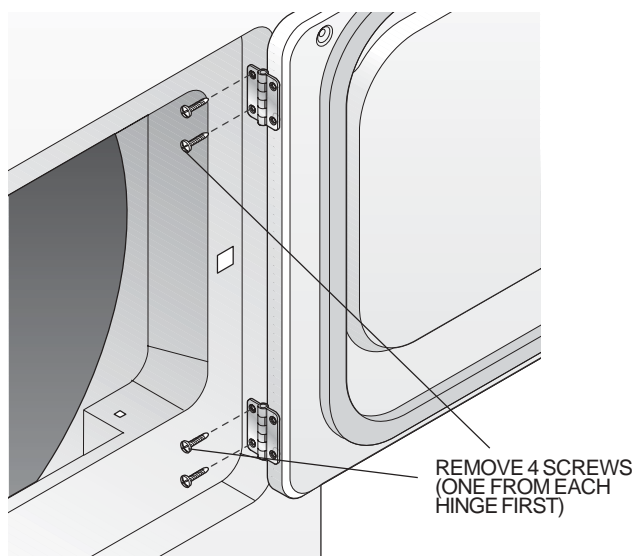

ELECTRICAL INSTALLATION

ELECTRIC Dryers

⚠ WARNING The following are specific requirements for proper and safe electrical installation of your dryer. Failure to follow these instructions can create electrical shock and/or a fire hazard.

⚠ This appliance **MUST** be properly grounded. Electrical shock can result if the dryer is not properly grounded. Follow the instructions in this manual for proper grounding.

⚠ Do not use an extension cord with this dryer. Some extension cords are not designed to withstand the amounts of electrical current this dryer utilizes and can melt, creating electrical shock and/or fire hazard. Locate the dryer within reach of the receptacle for the length power cord to be purchased, allowing some slack in the cord. Refer to the pre-installation requirements in this manual for the proper power cord to be purchased.

⚠ A U.L. approved strain relief must be installed onto power cord. If the strain relief is not attached, the cord can be pulled out of the dryer and can be cut by any movement of the cord, resulting in electrical shock.

⚠ Do not use an aluminum wired receptacle with a copper wired power cord and plug (or vice versa). A chemical reaction occurs between copper and aluminum and can cause electrical shorts. **The proper wiring and receptacle is a copper wired power cord with a copper wired receptacle.**

NOTE: Dryers operating on 208 volt power supply will have longer drying times than operating on 240 volt power supply.

GROUNDING REQUIREMENTS

ELECTRIC Dryer

⚠ DANGER Improper connection of the equipment grounding conductor can result in a risk of electrical shock. Check with a licensed electrician if you are in doubt as to whether the appliance is properly grounded.

For a grounded, cord-connected dryer:

1. The dryer **MUST** be grounded. In the event of a malfunction or breakdown, grounding will reduce the risk of electrical shock by a path of least resistance for electrical current.
2. If your dryer is equipped with a power supply cord having an equipment-grounding conductor and a grounding plug, the plug **MUST** be plugged into an appropriate, copper wired receptacle that is properly installed and grounded in accordance with all local codes and ordinances. If in doubt, call a licensed electrician.

For a permanently connected dryer:

1. The dryer **MUST** be connected to a grounded metal, permanent wiring system; or an equipment grounding conductor must be run with the circuit conductors and connected to the equipment-grounding terminal or lead on the appliance.

GAS Dryers

This dryer is equipped with a three-prong (grounding) plug for your protection against shock hazard and should be plugged directly into a properly grounded three-prong receptacle. Do not cut or remove the grounding prong from this plug.

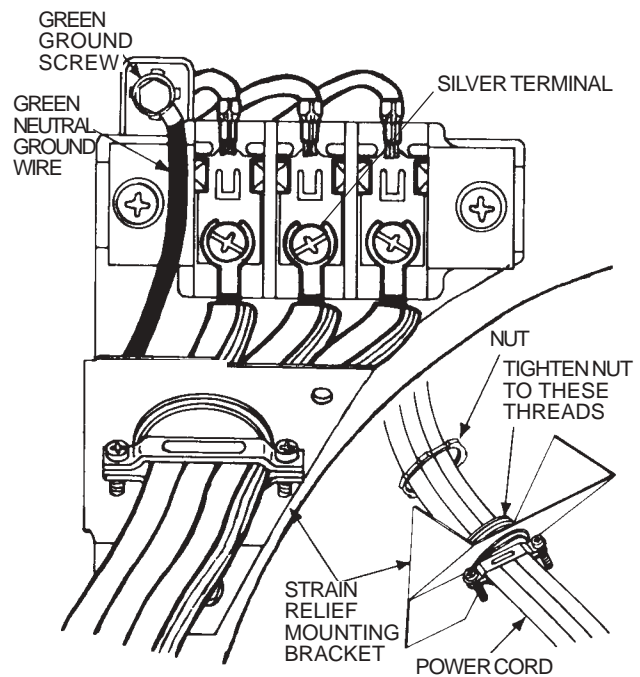

ELECTRICAL CONNECTIONS FOR 3-WIRE SYSTEM

ELECTRIC Dryer

1. Remove the screws securing the terminal block access cover and the strain relief mounting bracket located on the back of the dryer upper corner.
2. Install a U.L. approved strain relief into the power cord entry hole of the mounting bracket. Finger tighten the nut only at this time.
3. Thread a U.L. approved 30 amp. power cord, NEMA 10-30 Type SRDT, through the strain relief.
4. Attach the power cord neutral (center wire) conductor to the silver colored center terminal on the terminal block. Tighten the screw securely.
5. Attach the remaining two power cord outer conductors to the outer brass colored terminals on the terminal block. Tighten both screws securely.

⚠ WARNING Do not make a sharp bend or crimp wiring/ conductor at connections.

6. Reattach the strain relief mounting bracket to the back of the dryer with two screws. Tighten screws securely.
7. Tighten the screws securing the cord restraint firmly against the power cord.
8. Tighten the strain relief nut securely so that the strain relief does not turn.
9. Reinstall the terminal block cover.

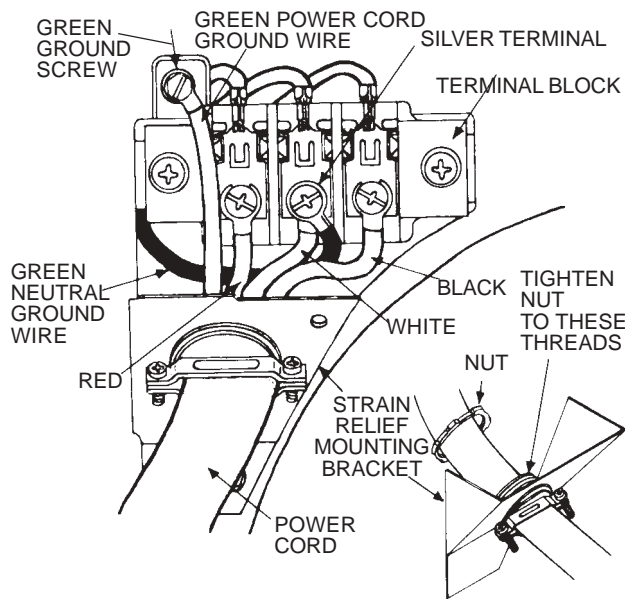

ELECTRICAL CONNECTIONS FOR 4-WIRE SYSTEM

ELECTRIC Dryer

1. Remove the screws securing the terminal block access cover and the strain relief mounting bracket located on the back of the dryer upper corner.
2. Install a U.L. approved strain relief in the entry hole of the mounting bracket. Finger tighten the nut only at this time.
3. Remove the green neutral ground wire from the green ground screw located above the terminal block.

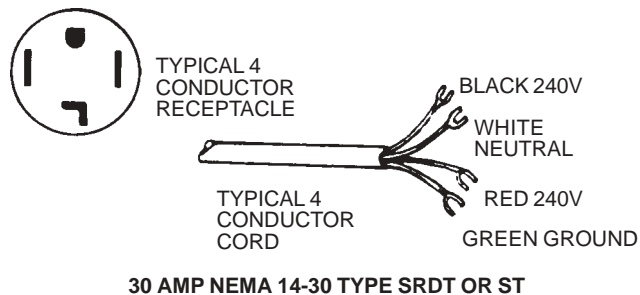

4. Thread a U.L. approved 30 amp power cord, NEMA 14-30 type ST or SRDT through the strain relief.
5. Attach the green power cord ground wire to the cabinet with the green ground screw.
6. Attach the white (neutral) power cord conductor from the power cord and the green ground wire from the dryer harness to the silver-colored center terminal on the terminal block. Tighten the screw securely.
7. Attach the red and black power cord conductors to the outer brass-colored terminals on the terminal block.

⚠ WARNING Do not make a sharp bend or crimp wiring/ conductor at the connections.

8. Tighten the screws securing the cord restraint firmly against the power cord.
9. Tighten the strain relief nut securely so the strain relief does not turn.
10. Reinstall the terminal block access cover.

GAS CONNECTION

1. Remove the shipping cap from gas pipe at the rear of the dryer.

NOTE: DO NOT connect the dryer to L.P. gas service without converting the gas valve. An L.P. conversion kit must be installed by a qualified gas technician.

2. Connect a 1/2 inch (1.27 cm) I.D. semi-rigid or approved pipe from gas supply line to the 3/8 inch (0.96 cm) pipe located on the back of the dryer. Use a 1/2 inch to 3/8 inch (1.27 cm to 0.96 cm) reducer for a connection. Apply an approved thread sealer that is resistant to the corrosive action of liquefied gases on all pipe connections.
3. Open the shutoff valve in the gas supply line to allow gas to flow through pipe.
4. Test all connections by brushing on a soapy water solution. **NEVER TEST FOR GAS LEAKS WITH AN OPEN FLAME.**

GENERAL INSTALLATION

1. Connect the exhaust duct to outside exhaust system. Use duct tape to seal all joints.
2. With the dryer in its final position, adjust one or more of the legs until the dryer is resting solid on all four legs. Place a level on top of the dryer. **THE DRYER MUST BE LEVEL AND RESTING SOLID ON ALL FOUR LEGS.**

3. Plug the power cord into a grounded outlet.

NOTE: Check to ensure the power is off at circuit breaker/ fuse box before plugging the power cord into the outlet.

5. Turn on the power at the circuit breaker/fuse box.

⚠ CAUTION Before operating the dryer, make sure the dryer area is clear and free from combustible materials, gasoline, and other

flammable vapors. Also see that nothing (such as boxes, clothing, etc.) obstructs the flow of combustion and ventilation air.

6. Run the dryer through a cycle check for proper operation.

NOTE: On gas dryers, before the burner will light, it is necessary for the gas line to be bled of air. If the burner does not light within 45 seconds the first time the dryer is turned on, the safety switch will shut the burner off. If this happens, turn the timer to "OFF" and wait 5 minutes before making another attempt to light.

7. If your dryer does not operate, please review the "Avoid Service Checklist" located in your Use and Care Guide before calling for service.
8. Place these instructions in a location near the dryer for future reference.

REPLACEMENT PARTS

If replacement parts are needed for your dryer, contact the source where you purchased your dryer.

⚠ CAUTION Label all wires prior to disconnection when servicing controls. Wiring errors can cause improper and dangerous operation. Verify proper operation after servicing.

⚠ WARNING Destroy the carton and plastic bags after the dryer is unpacked. Children might use them for play. Cartons covered with rugs, bedspreads, or plastic sheets can become airtight chambers causing suffocation. Place all materials in a garbage container or make materials inaccessible to children.

⚠ WARNING The instructions in this manual and all other literature included with this dryer are not meant to cover every possible condition and situation that may occur. Good safe practice and caution **MUST** be applied when installing, operating and maintaining any appliance.

SECTION D - STACKING INSTRUCTIONS

Electronic Tumble Action Washer/Dryer

⚠ WARNING To reduce the risk of electrical shock, disconnect this appliance from the power supply before attempting any user maintenance. Turning the controls to the OFF position does not disconnect this appliance from the power supply.

⚠ WARNING Refer to the washer and dryer installation instructions packed with each appliance prior to stacking appliances. Reading all of the information contained in these instructions will simplify the installation and ensure a correct and safe operation. A fire hazard and/or personal injury could result from improper installation.

TOOL & EQUIPMENT REQUIREMENTS:

1. Phillips screwdriver.
2. Flat blade screwdriver.
3. Channel-lock pliers.

KIT COMPONENTS

2 – Rear Stacking Brackets



2 – Front Stacking Brackets



4 – #8-18 x ½ inch screws



2 – #10-16 x 1 inch screws



2 – Stacking Spacers (left & right)



A. Remove Washer Top Panel

1. Remove the washer top panel by removing the two (2) screws at the rear of the top panel. Slide the top panel rearward to remove. Save the two screws for dryer support spacer installation.
2. Carefully remove the foam pad from the top of the washer and affix to the underside of the top panel. Save the top panel in case of future side by side use.

B. Install Mounting Brackets

1. Remove the four (4) screws and two (2) brackets from the rear support brace of the washer. Save the brackets for future side by side use.
2. Using the four (4) screws that were removed in step B1, install the two (2) rear stacking brackets onto the rear support brace as shown.



3. Install the two (2) front stacking brackets onto the washer with four (4) screws, provided in the kit. Drive the screws through the indentations in the plastic with the tab of the front stacking bracket facing forward as shown.



C. Install Dryer Support Spacer

1. On the left side of the washer, remove the screw and plastic clip toward the front of the washer. Also, remove the rear screw from the spring retainer. Save the plastic clip for future side by side use.

Plastic Clip



Spring Retainer



2. Place the left (L) dryer support spacer onto the left side of the washer and install with the two (2) screws that were removed in step C1 and one (1) screw that was removed in step A1.



3. Repeat steps C1-C2 with the right (R) dryer support spacer.

D. Prepare Dryer for Stacking

1. Carefully remove the hole plugs located in the bottom of the dryer front panel, they will be reinstalled after stacking. Use a flat blade screw driver to push out from behind.
2. Remove the four (4) legs from the dryer base. Save for future side by side use.

E. Stack the Dryer

1. Place the dryer on top of the support spacers. With the dryer tilted slightly, slide back into the rear mounting brackets, then lower the front down over the front stacking brackets.



2. Insert the two (2) long screws, provided in the kit, through the holes in the dryer front panel and install into the front stacking brackets.
3. Install the hole plugs removed in step D1.

F. Washer and Dryer Operation

1. Refer to the washer and dryer installation and operating instructions for proper installation and operation.

SECTION E - HOW THE COMPONENTS WORK

Clothes dryers remove moisture from clothes by pulling air, either warmed or room temperature, through the clothes while they are being tumbled by a turning drum. The moisture from the clothes is exhausted through the dryer vent system to the outside of the house.

The basic components are :

Drum



Heat Source



Electric

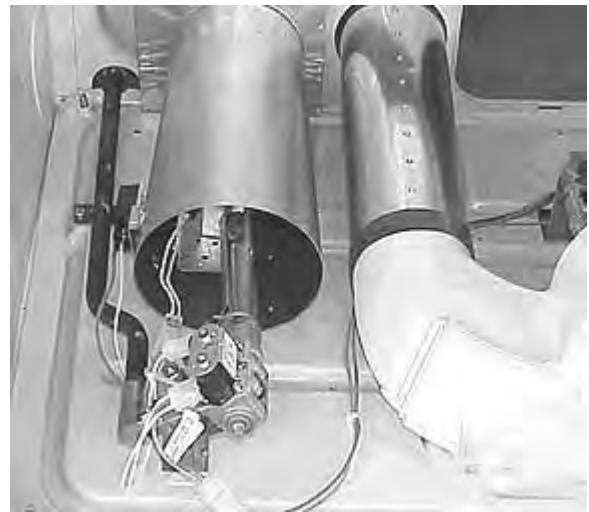

Gas

Drive motor and blower



Control thermistor

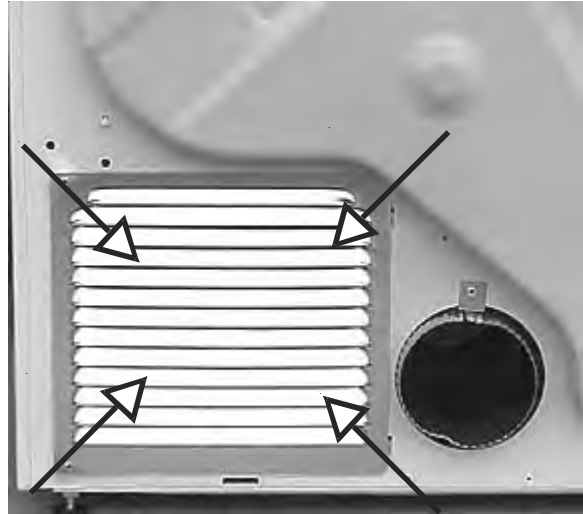

Electronic control board

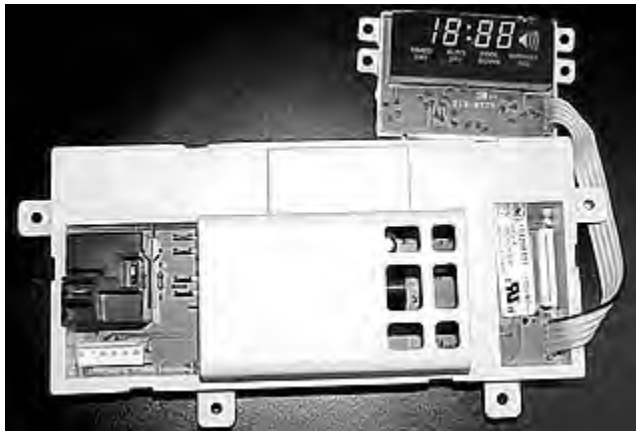

Once inside the dryer cavity the air is drawn between the rear wall of the dryer and the plenum. The holes in the plenum allow the air to be drawn across the heating element. In any cycle, other than Air Fluff, the heating element heats the air as it passes through.

Airflow

Since the moisture in the clothes is removed by air moving through the drum, it is important to understand the complete air flow system.

Airflow electric dryers:

Room air enters the dryer through a louvered panel in the rear right-hand corner of the dryer.

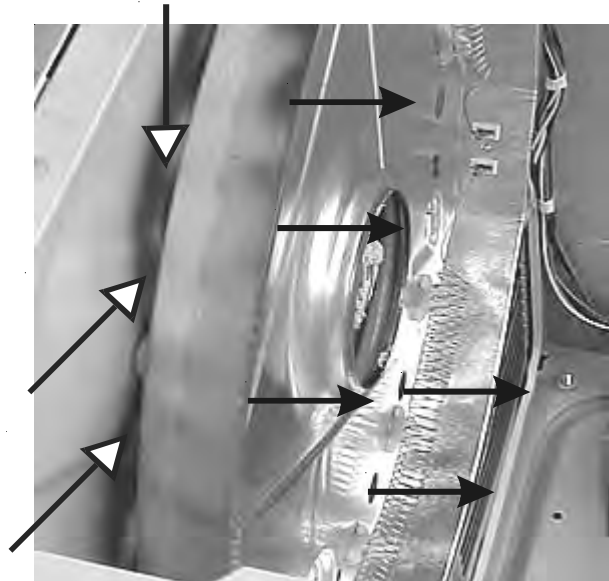

The air then is drawn into the drum through the holes in the rear of the drum.

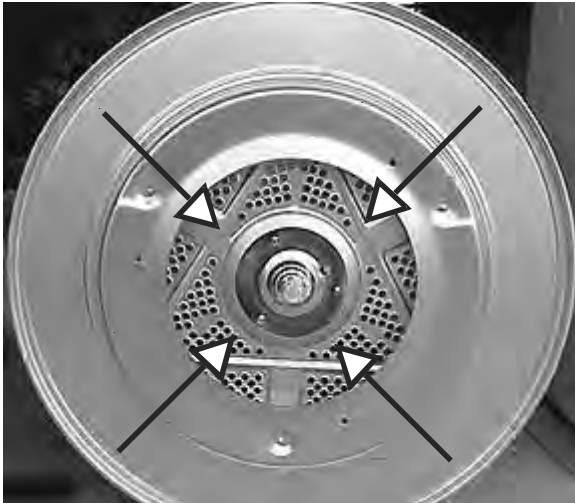

The air passes through the drum picking up moisture and is drawn through the lint filter into the ductwork at the front of the dryer.

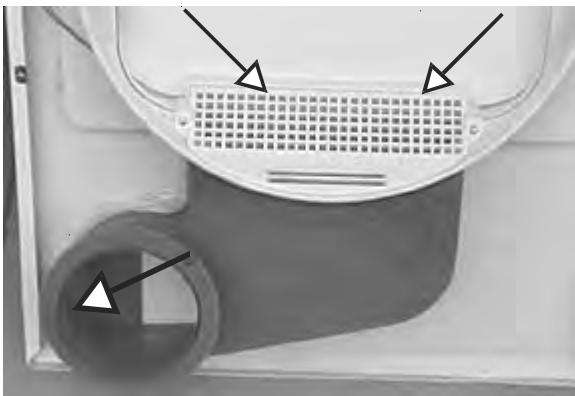

The air enters the fan housing and is pushed out the exhaust vent to the outside of the house.

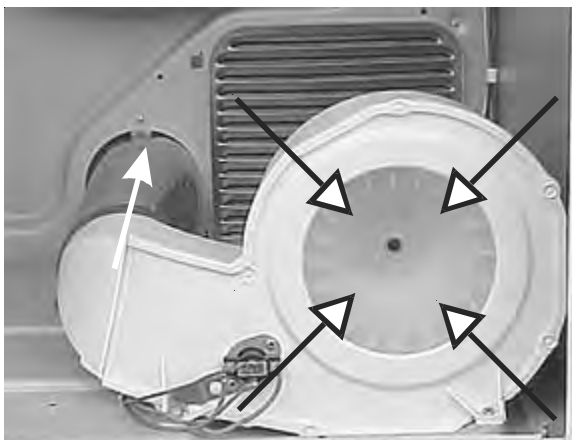

Airflow gas dryers:

The airflow in gas dryers is similar to electric dryers except for the heat source and the rear of the drum. The air enters the cavity through the louvered opening in the right rear corner of the dryer. The air is pulled across the gas burner, through the burner chamber and is ducted to the rear of the drum.



The drum is the same as in the electric dryer, except it does not have a heat baffle on it.



Airflow problems:

Airflow problems are usually caused by restrictions, leaks or short unrestricted vents resulting in longer drying times, hotter dryer surfaces and in extreme cases causing the thermal limiter to open on electric dryers.

Restrictions:

Restrictions can occur any place in the airflow system, but the most common are:

1. Installing the dryer in a small inclosed area; such as a closet without a louvered door that reduces the intake air.
2. Fan problems caused by either a slow running motor, a broken or deformed fan blade or a deformed fan housing.
3. A lint restriction in the lint screen area. Operator may not be cleaning the lint screen before using.
4. A restriction in the exhaust system in the house caused by the design of the vent, such as; the diameter of the vent pipe being too small, too long, too many right angles, or a collapsed or lint restricted vent pipe.

Note: Problems caused by the vent pipe in the house are not cover under the product warranty.

Air leaks:

Two types of air leaks may occur:

1. Air being drawn in around the door opening, between the drum and the front panel, or around the foam seal between the front duct and the blower housing, replaces some of the air being drawn through the drum and lowers the efficiency of the dryer.

Note: An air leak that occurs around the door opening or between the drum and the front panel usually will cause lint to build up on the inner panel of the door.

2. Air being pushed out around the blower housing or vent pipe inside the dryer, allows some of the moisture that has been removed from the clothes to be recirculated.

Short unrestricted vents:

The venting system in the dryer is designed to operate under some back pressure. This back pressure is needed to slow the airflow and allow the air to be heated before it passes through the clothes.

Note: With short direct vent runs; such as you have when the dryer is installed against an outside wall, use a 2 1/2" vent cap rather than a 4" vent cap.

Electrical Operation (Electric Dryers Models)

Note: Always refer to the wiring diagram or schematic with the product.

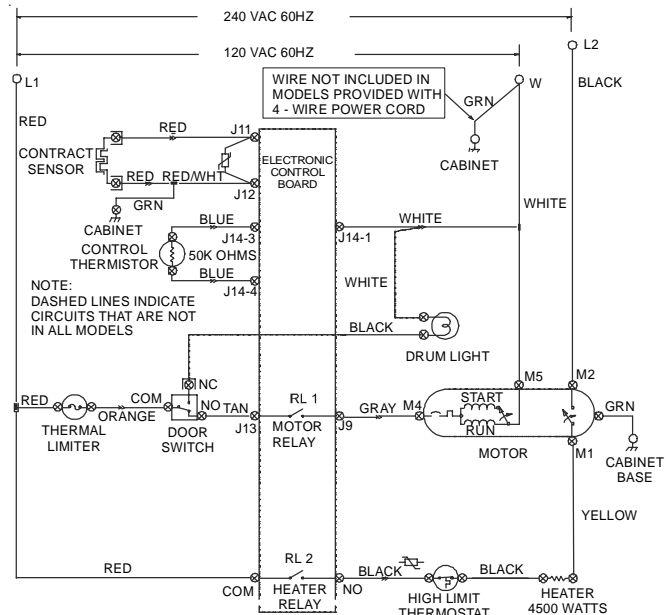

When the dryer is connected to electrical power, line 1 is connected to one side of the thermal limiter and the COM terminal of the heater relay RL 2 that is mounted

on the electronic control board. The COM. terminal provides power to the common contact of the relay and also provides power to the electronic control board. The electronic control board controls the operating temperature of the dryer and length of the cycle by either sensing the amount of moisture in the clothes or a fixed amount of time when time dry is used.

Note: If the red and black wires on the relay are reversed, the control will not operate. Always connect the red wire to the terminal mark COM.

Note: For information on programming the electronic control and the cycles refer to section A.

Electronic Control Board Circuits:

Line 1 is applied to the control board at the common terminal of RL 2 and neutral on pin 1 of the six pin plug. The control board receives inputs from the membrane switches which programs the control, the contact sensors that sense the amount of moisture in the clothes and the control thermistor which senses the temperature in the dryer. The control board uses these inputs to control the drive motor circuit by opening and closing the contacts of relay RL 1 and the heater circuit by opening and closing the contacts of relay RL 2.

Drive Motor Circuit:

When power is connected to the dryer, line 1 is applied through the thermal limiter (a non-resettable fuse mounted on the rear wall of the dryer) to the COM. terminal of the door switch.

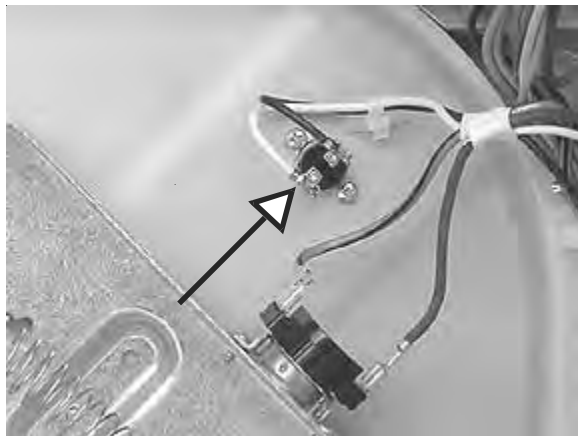

When the door is closed the COM terminal is connected to terminal NO. of the door switch. From terminal NO. power is applied to terminal J13 of the motor relay RL 1 on the control board. When the control board closes

relay RL 1 power is applied through terminal J9 to terminal M4 of the drive motor.

Terminal M4 is connected inside the motor to one side of the thermal overload. (The thermal overload protects the motor from being damaged by overheating.) The other side of the thermal overload is connected to one end of both the run winding and the start winding of the drive motor. When the motor is not turning, the other end of the start winding is connected internally to terminal M5 of the motor through the NC contact of the motor centrifugal switch. The other end of the run winding is also connected internally to terminal M5.

When the motor is not turning, the start winding and the run winding are connected in parallel. When the contacts of relay RL 1 are closed, with the dryer door closed, line 1 and neutral voltage is applied across both the start and run windings of the drive motor. With power applied to both the start and run windings, the motor starts to turn.

When the speed of the motor reaches about 80% of its normal run speed the contacts of the centrifugal switch remove power from the start winding thus removing the start winding from the circuit.

The drive motor performs two tasks in the dryer. A pulley attached to one end of the motor shaft uses a belt to drive the dryer drum. The blower wheel is attached to the other end of the motor shaft to pull the air through the clothes and force it out the exhaust vent.

Temperature Sensing Circuit:

The temperature in the dryer is controlled by the control thermistor and the electronic control board. The control thermistor is mounted in the blower fan housing and is a negative coefficient thermistor that decreases in resistance as the temperature increases.



The electronic control board reads the resistance of the thermistor and converts it into temperature.

It compares the reading from the thermistor to the temperature setting for the cycle.

The Heating Circuit:

The electronic control board applies power to the heating circuit through the contacts of heater relay RL 2. When the electronic control senses the temperature in the drum is below the programmed temperature, it closes the contact of RL 2. This applies line 1 power to the high limit thermostat that is mounted on the heating element assembly.

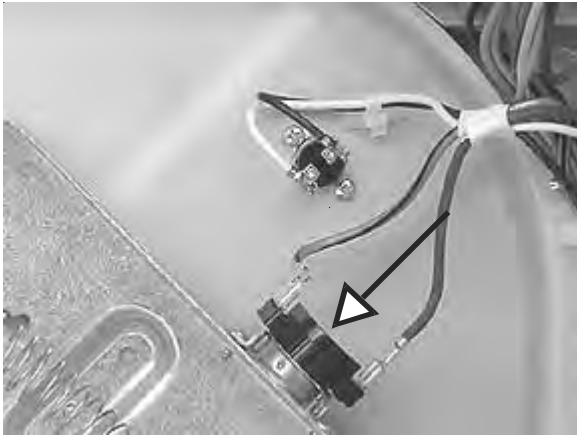

The high limit thermostat is a safety device that prevents the dryer from overheating if the contacts of the RL 2 fail closed. The contacts of the high limit thermostat are normally closed and are set to open at a temperature above the preset temperature specifications of the electronic control board. From the output terminal of the high limit thermostat, line 1 is connected to one side of the element. The other side of the heating element is connected to line 2 through the contacts of the second centrifugal switch in the drive motor. This switch prevents power from being applied to the element if the motor is not running.

Drying Time:

The amount of drying time is determined in one of two ways. A fixed amount of drying time may be set by touching the TIMED DRY pad. The AUTO DRY cycles that variable amount of time by the size of the load, the amount of moisture in the clothes and the dryness setting selected.

Pressing TIME DRY will select 45 minutes of drying time. The time will increase 5 minutes each time TIME DRY is pressed. The maximum drying time is approximately 110 minutes. If you desire less than 45 minutes, you must advance beyond the 110 minute mark to start again at 15 minutes.

In the AUTO DRY cycles the electronic control reads the capacitance between the two sensor bars located in the vent cover.



When wet clothes are placed in the dryer, the clothes touch the sensor bars and the moisture lowers the capacitance between the bars. As the dryer runs, moisture is removed from the clothes, the capacitance between the bars increases. When the increase in capacitance satisfies the electronic control, the cycle status will change from “Auto Dry” to “Cool Down” and the load is tumbled without heat. At the end of cycle “dn” is displayed and the electronic control will turn the dryer off.

Electrical Operation (Gas Dryers Models)

Note: Always refer to the wiring diagram or schematic with the product.

Sample wiring diagram.

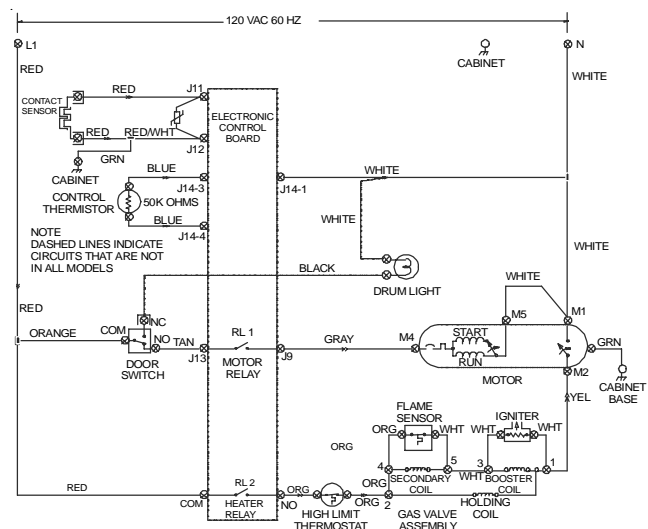

When the dryer is connected to electrical power, line 1 is connected to the terminal marked COM on the door switch and the COM. terminal of the heater relay that is mounted on the electronic control board. The COM. terminal of the heater relay provides power to the common contact of the relay and also provides power to the electronic control board. The electronic control board

controls the operating temperature of the dryer and length of the cycle by either sensing the amount of moisture in the clothes or a fixed amount of time when time dry is used.

Note: If the red and orange wires on the relay are reversed the control will not operate. Always connect the red wire to the terminal mark COM.

Note: For information on programming the electronic control and the cycles, refer to section A.

Electronic Control Board Circuits:

Line 1 is applied to the control board at the common terminal of RL 2 and neutral is connected on pin 1 of the six pin plug. The control board receives inputs from the membrane switches which programs the control, the contact sensors that sense the amount of moisture in the clothes and the control thermistor which sense the temperature in the dryer. The control board use these input to control the drive motor circuit by open and closing the contacts of relay RL 1 and the heater circuit by opening and closing the contracts of relay RL 2.

Drive Motor Circuit:

When power is connected to the dryer, line 1 is applied to the COM. terminal of the door switch. When the door is closed the COM. terminal is connected to terminal NO. of the door switch. From terminal NO, power is applied to terminal J13 of the motor relay RL 1 on the control board through terminal J13 of the control board. When the control board closes relay RL 1 power is applied through terminal J9 to terminal M4 of the drive motor.

Terminal M4 is connected inside the motor to one side of the thermal overload. (The thermal overload protects the motor from being damaged by overheating.) The other side of the thermal overload is connected to one end of both the run winding and the start winding of the drive motor. When the motor is not turning, the other end of the start winding is connected internally to terminal M5 of the motor through the NC contact of the motor centrifugal switch. The other end of the run winding is also connected internally to terminal M5.

When the motor is not turning, the start winding and the run winding are connected in parallel. When the contacts of relay RL 1 are closed, with the dryer door closed, line 1 and neutral voltage is applied across both the start and run windings of the drive motor. With power applied to both the start and run windings, the motor starts to turn.

When the speed of the motor reaches about 80% of it's normal run speed the contacts of the centrifugal switch remove power from the start winding thus removing the start winding from the circuit.

The drive motor preforms two tasks in the dryer. A pulley attached to one end of the motor shaft uses a belt to drive the dryer drum. The blower wheel is attached to the other end of the motor shaft to pull the air through the clothes and force it out the exhaust vent.

Temperature Sensing Circuit:

The temperature in the dryer is controlled by the control thermistor and the electronic control board. The control thermistor is mounted in the blower fan housing. The thermistor is a negative coefficient thermistor that decrease in resistance as the temperature increases.

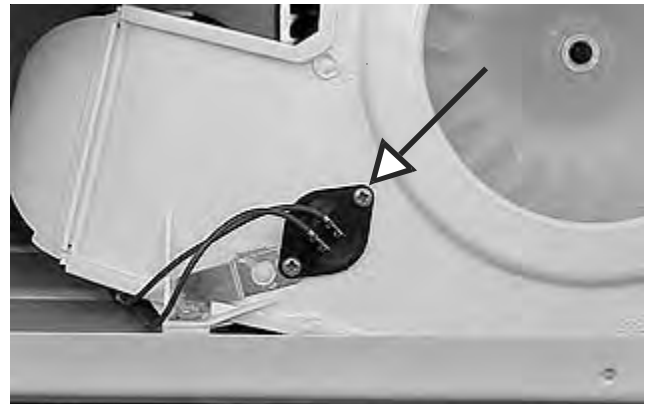

The electronic control board reads the resistance of the thermistor and converts it into temperature. The electronic control compares the reading from the thermistor to the temperature setting for the cycle and cycles the heating circuit accordingly.

The Heating Circuit:

The electronic control board applies power to the heating circuit through the contacts of relay RL 2. When the electronic control senses that the temperature in the drum is below the programmed temperature, it closes the contact of heater relay RL 2 applying line 1 to the high limit thermostat. The high limit thermostat is a safety device that prevents the dryer from overheating if the contacts of the relay RL 2 fail closed. The contacts of the high limit thermostat are normally closed and are set to open at a temperature above the preset temperature specifications of the electronic control board. From the output terminal of the high limit thermostat, line 1 is connected to one side of the holding coil of the gas valve, the secondary coil of the gas valve and the sensor that is mounted on the burner chamber.

The holding coil, secondary coil, booster coil, sensor and igniter circuits interact with one another to assure safe operation of the dryer gas burner.

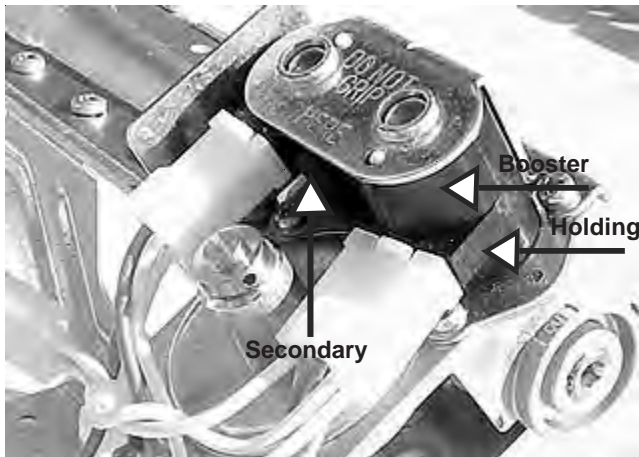

The gas valve has two chambers in series, both must be opened before gas will flow into the burner. The solenoid that controls the gas flow through the first chamber has two coils: the booster coil and the holding coil. The solenoid that control the second chamber has one coil, the secondary coil.

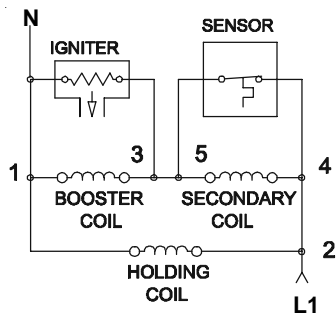

The other side of the holding coil, booster coil and igniter are connected to neutral through the second centrifugal switch in the motor (closed when the motor is running). When power is applied across these circuits, current flows through the holding coil, but the holding coil does not have enough magnetic force to open the solenoid by itself. At the same time, current flows through sensor contacts providing power to the booster coil and the igniter. When current flows through both the holding and booster coils, the first chamber opens. The contacts of the sensor are in parallel with the secondary coil. As long as the contacts of the sensor remain closed, current flow bypasses the secondary coil, and gas is prevented from flowing through the second chamber of the valve to the burner.

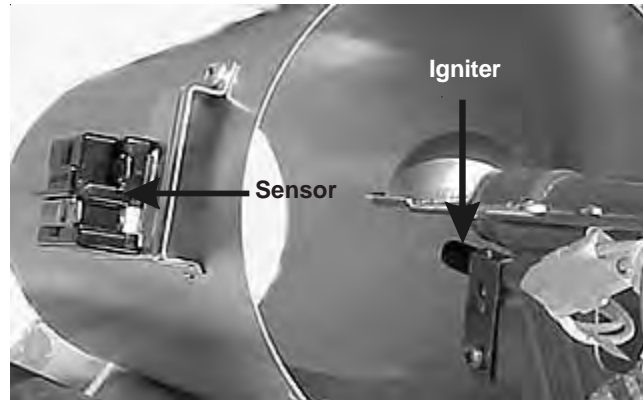

It is necessary to raise the temperature above 1100° F to ignite gas. As current flows through the igniter, the temperature of igniter raises from room temperature to approximately 1800° F within 30 seconds. The contacts of the sensor are heat sensitive and set to open above the ignition temperature of gas. When the sensor contacts open, current flows through the secondary coil, opening the second chamber, allowing gas to the burner, and is ignited by the heat of the igniter. When the contacts of the sensor are open, the parallel circuit formed by the igniter and the booster coil are in series with the secondary coil which lowers the current flow through the igniter and booster coil. Since it takes less magnetic force to hold a solenoid open than it does to open it, the first solenoid remains open when the current through the booster coil is reduced. The reduction of current flow through the igniter reduces heat from the igniter but the sensor contacts are held open by the heat of the burner flame.

Drying Time:

The amount of drying time is determined in one of two ways. A fixed amount of drying time that may be set by touching the TIMED DRY pad or the AUTO DRY cycles that varies amount of time by the size of the load, the amount of moisture in the clothes and the dryness setting selected.

Pressing TIME DRY selects 45 minutes of drying time. The drying time will increase 5 minutes each time TIME DRY is pressed. The maximum drying time is approximately 110 minutes. If you desire less than 45 minutes, you must advance beyond the 110 minute mark to start at 15 minutes.

In the AUTO DRY cycles, the electronic control measures the capacitance between the two sensor bars located in the vent cover.



When wet clothes are placed in the dryer, the clothes touch the sensor bars and the moisture lowers the capacitance between the bars. As the dryer runs the moisture is removed from the clothes, the capacitance between the bars increases. When the increase in capacitance satisfies the electronic control the cycle status will change from “**Auto Dry**” to “**Cool Down**”, the load is then tumbled without heat. At the end of cycle, “dn” is displayed and the electronic control turn the dryer off.

SECTION F - TROUBLESHOOTING FLOW CHARTS

NOTE: Always check the wiring and pin/plug connectors before replacing any component.

NOTE: If a fault code is displayed the dryer will not operate.

Refer to page 8 for information on fault codes.

Electric dryer completely inoperative. _____	49
Gas dryer completely inoperative. _____	50
Electric and Gas dryers; blower motor runs but drum does not turn. _____	51
Electric and Gas dryers; longer than normal drying times. _____	51
Electric dryer not heating properly. _____	52
Gas dryer not heating properly. _____	53
Electric and Gas dryers; dryer over heating. _____	53
Electric dryers; blower motor runs but dryer does not heat. _____	54
Gas dryers; blower motor runs but dryer does not heat. _____	55
Electric and Gas dryers; clothes not dry in auto cycle. _____	56

Electric dryer completely inoperative.

Note: Always check wiring to the components.

Note: If a fault code is displayed the dryer will not operate.

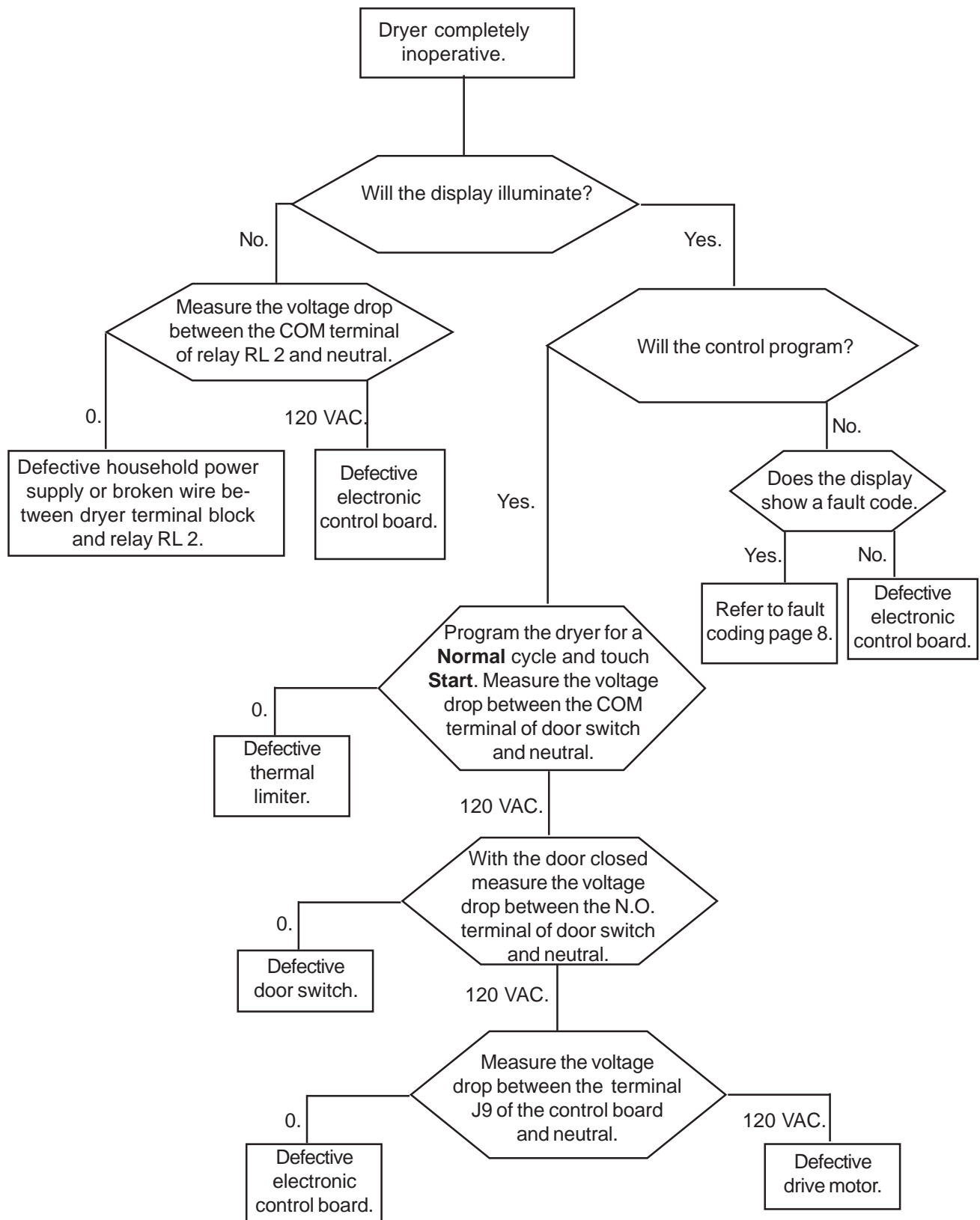

Gas dryer completely inoperative.

Note: Always check wiring to the components.

Note: If a fault code is displayed the dryer will not operate.

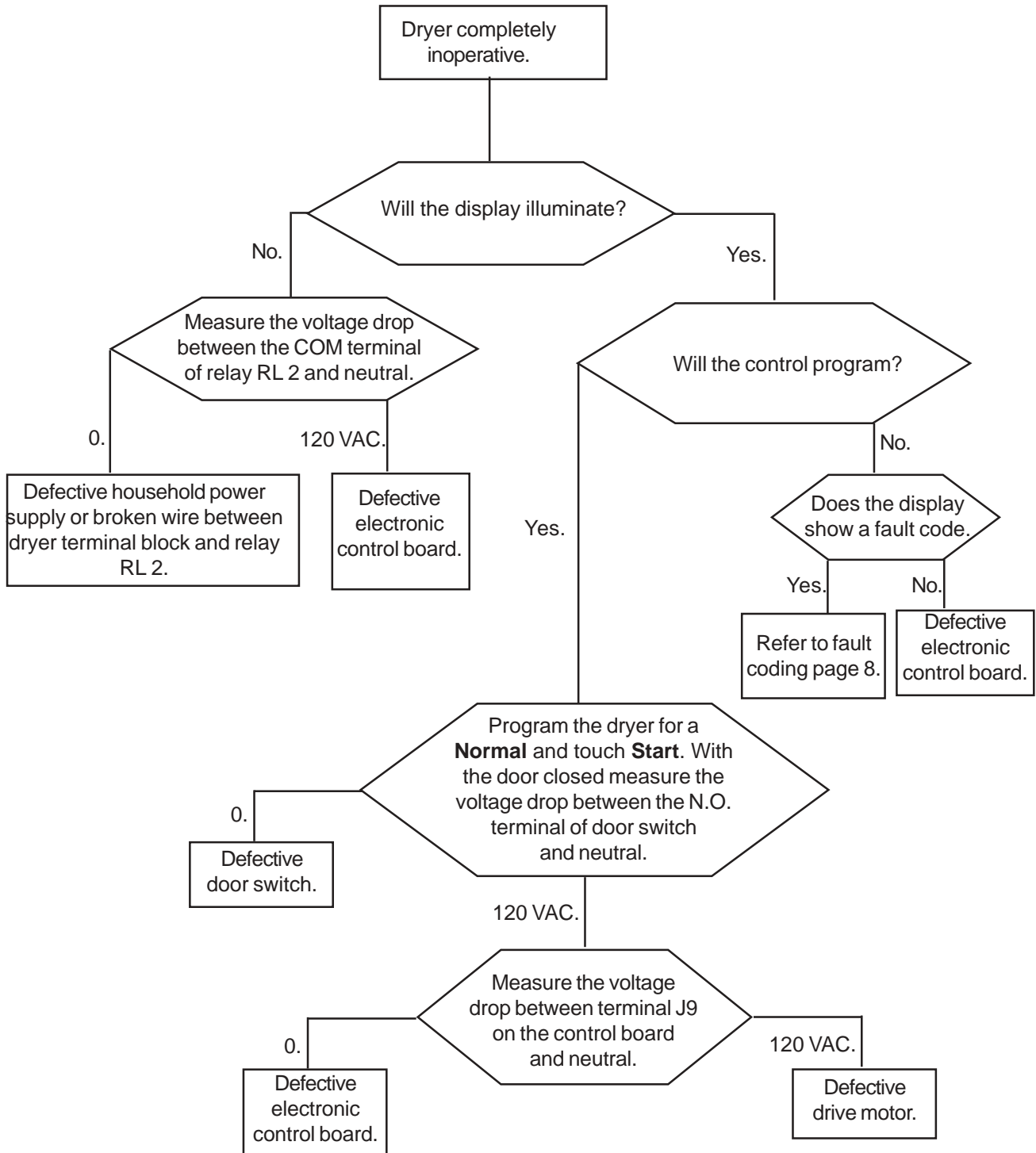

Electric and Gas dryers; blower motor runs but drum does not turn.

Note: Always check wiring to the components.

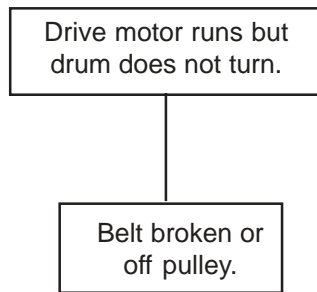

Electric and Gas dryers; longer than normal drying times. (Possible F05)

Note: Always check wiring to the components.

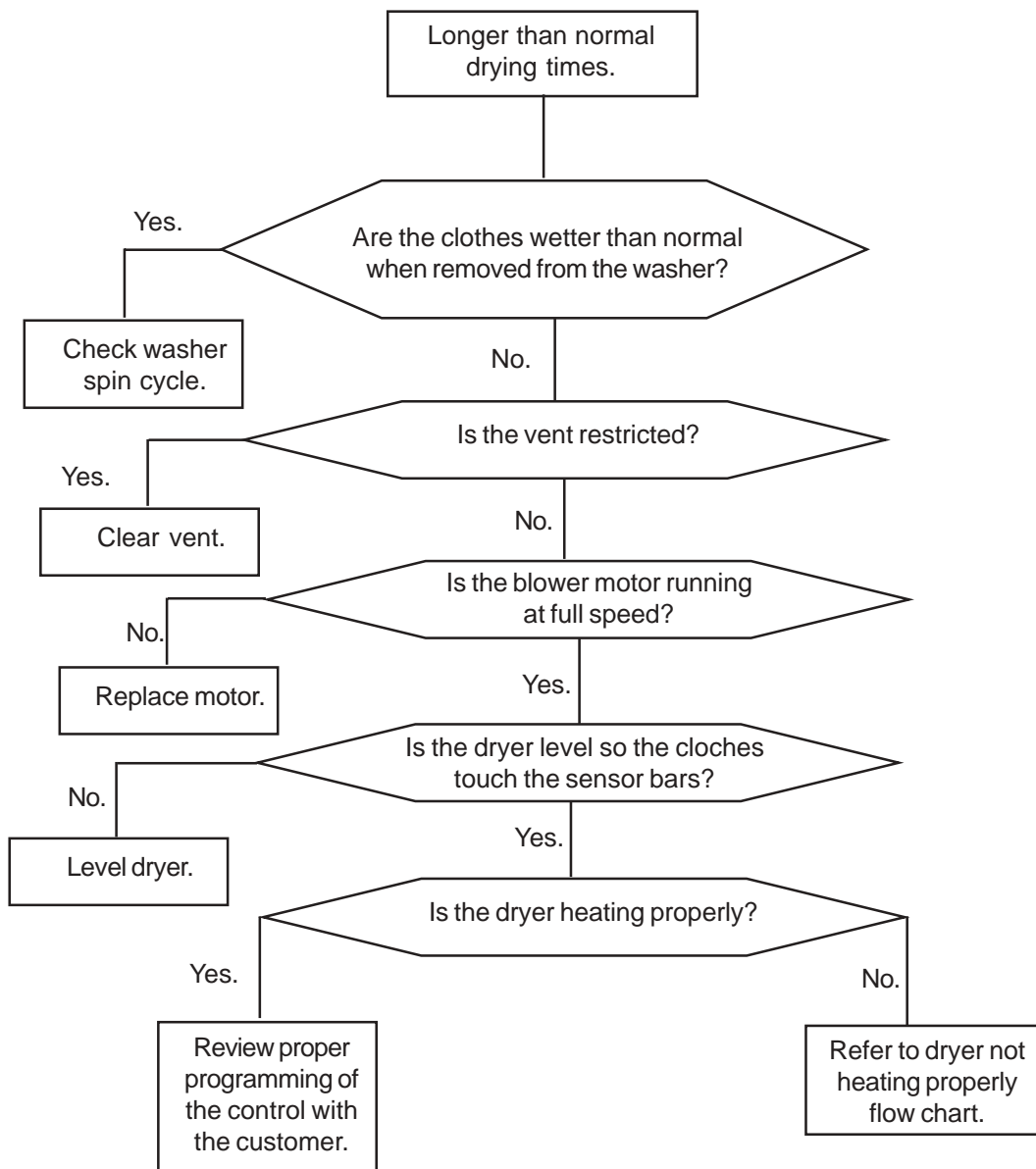

Electric dryers not heating properly

Note: Always check wiring to the components.

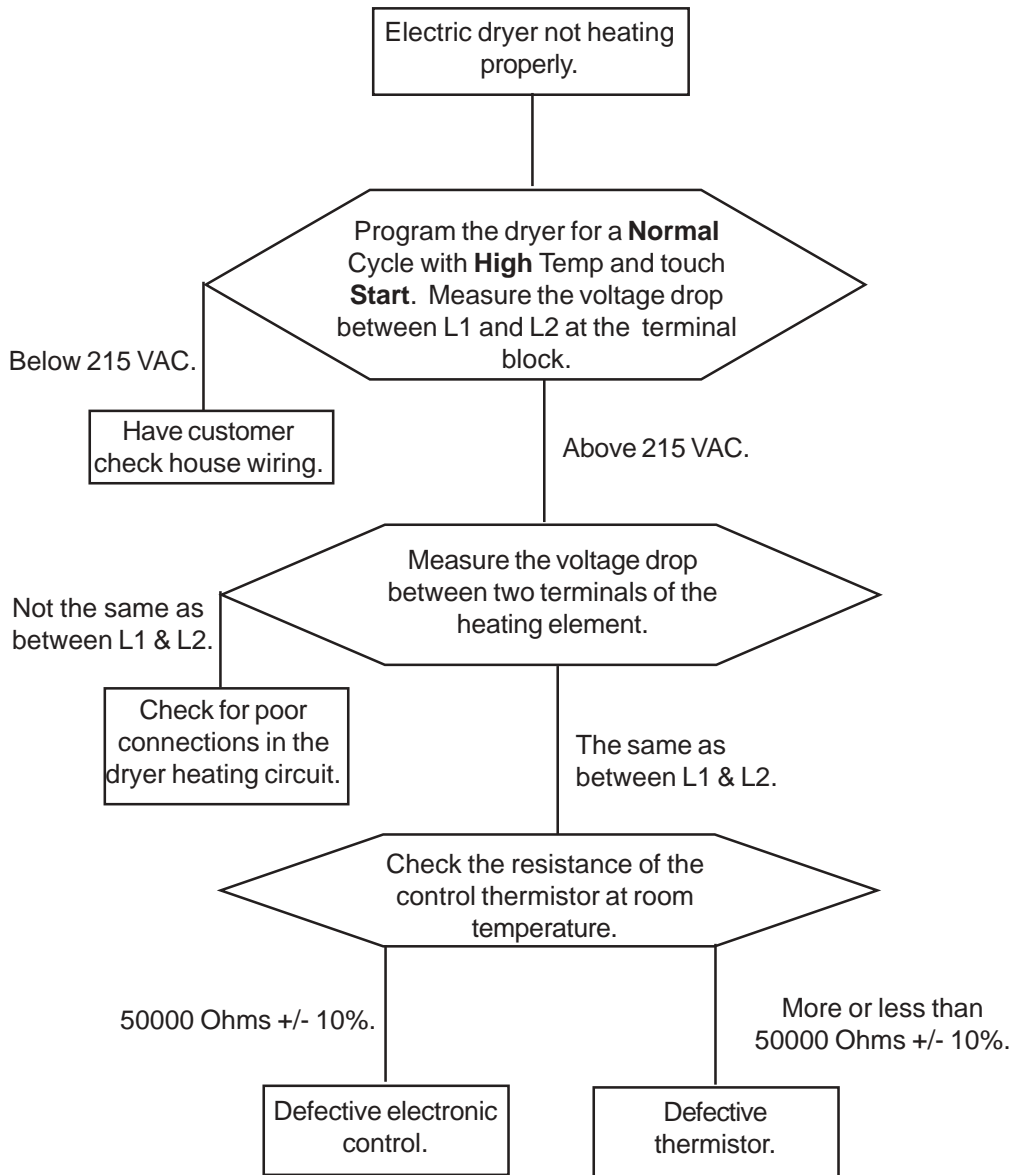

Gas dryers not heating properly

Note: Always check wiring to the components.

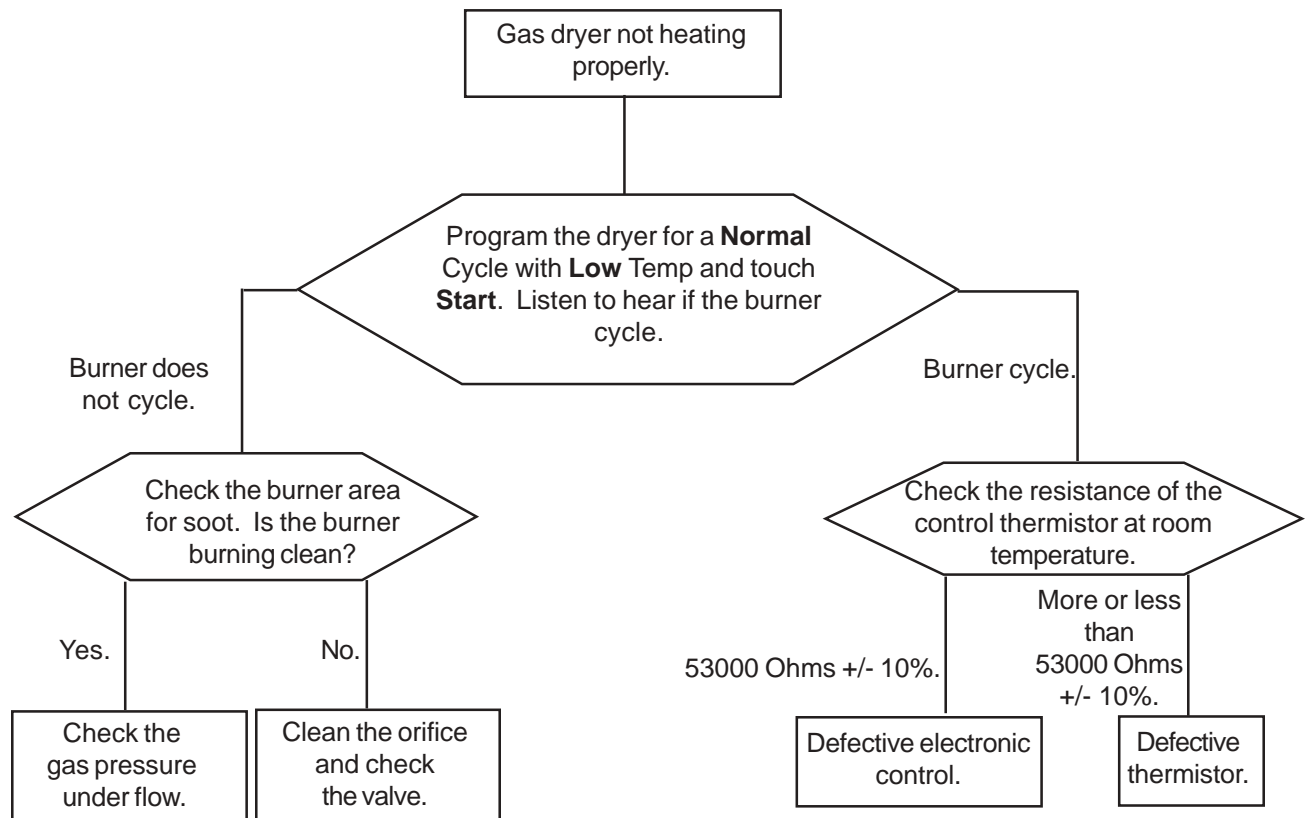

Electric and Gas dryers; dryer over heating.

Note: Always check wiring to the components.

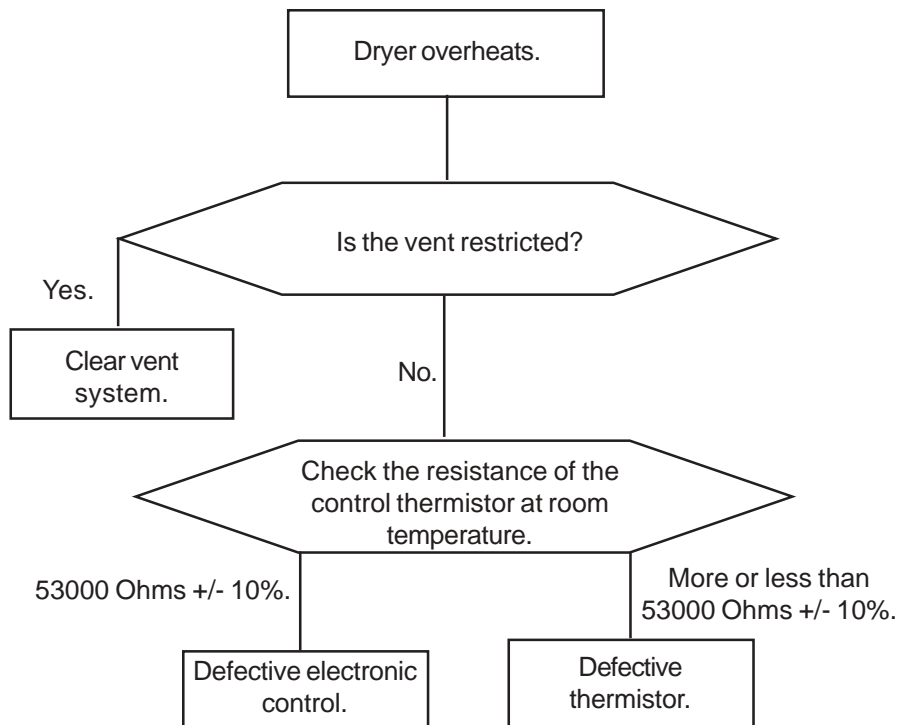

Electric dryers; drive motor runs but dryer does not heat.

Note: Always check wiring to the components.

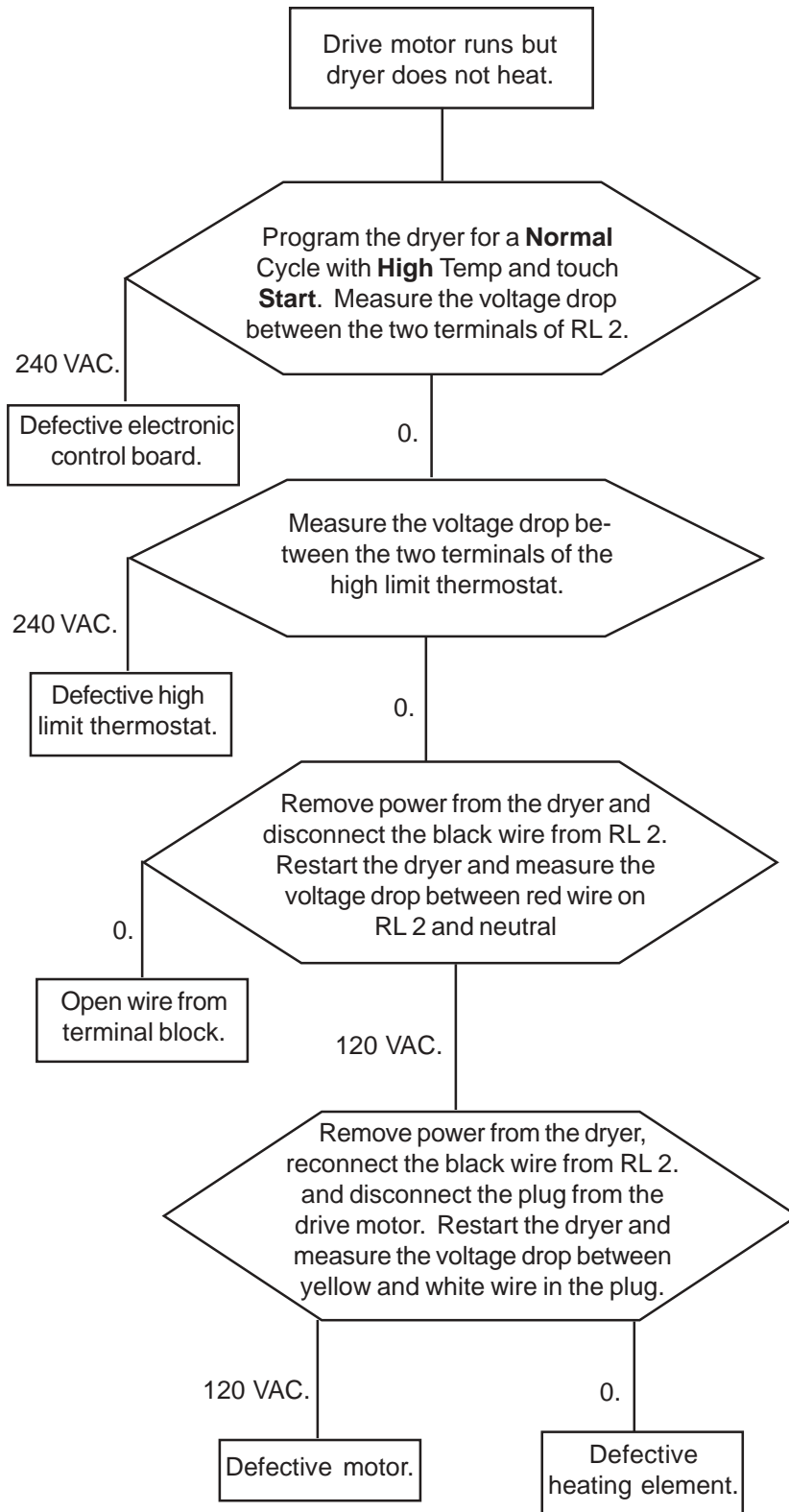

Gas dryers; drive motor runs but dryer does not heat.

Note: Always check wiring to the components.

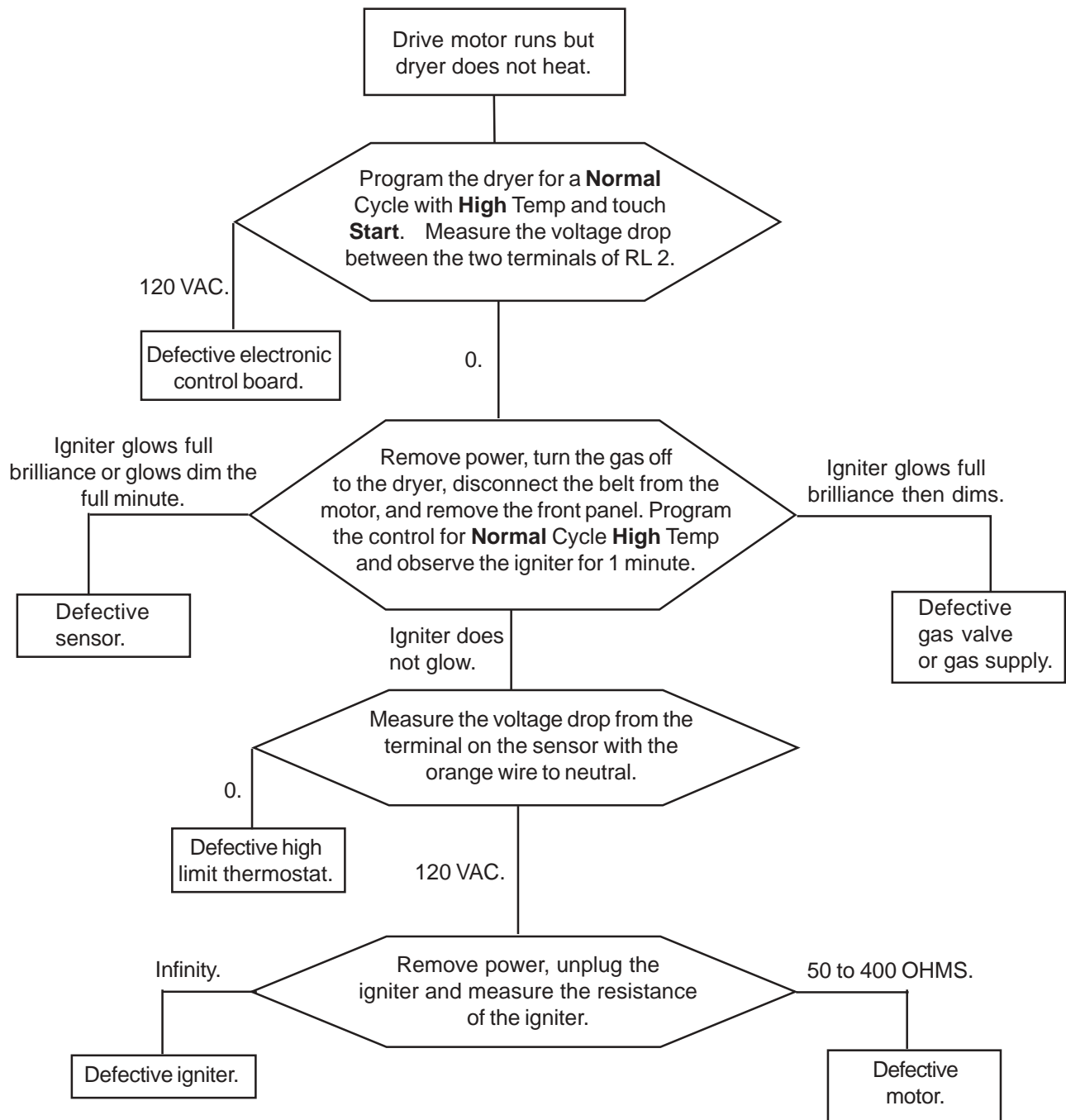

Electric and Gas dryers; clothes not dry in auto cycle.

Note: Always check wiring to the components.

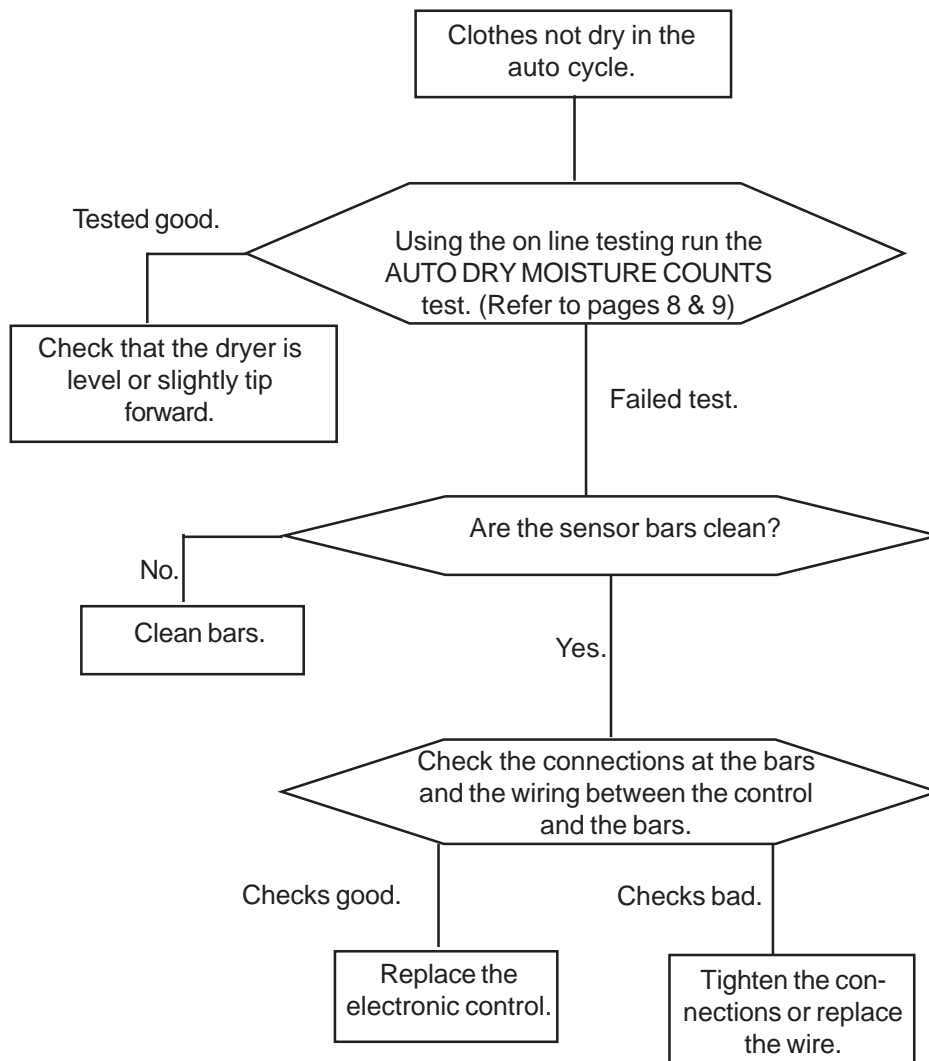

SECTION G - TEARDOWN

This section will describe how to remove components from both gas and electric dryer. Unless stated, the procedure will be the same on all dryers. Unless stated, reverse the procedure to reinstall the component.

⚠ WARNING Always remove electrical power from the dryer when working in an area where electrical power is present.

⚠ WARNING Always turn the gas off to the dryer before opening any gas piping.

Removing the top panel:

1. The top panel is held in place in the front by four plastic pins and two metal tabs.

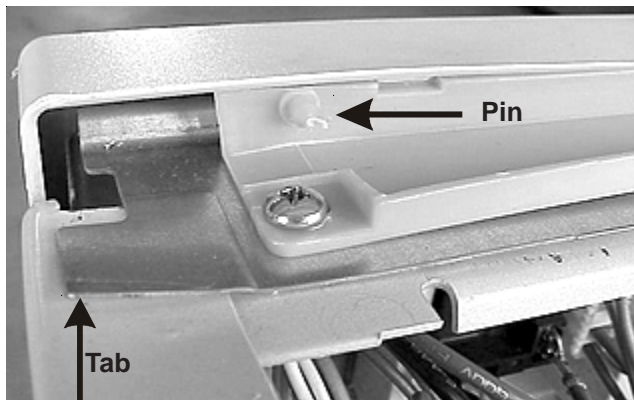

In the rear by two screws.



2. Remove the two screws, slide the top back about 1/2 inch and lift the top off.

Removing the console drip rail:

1. Remove the top panel.

2. Remove the 2 screws, one at each end, that hold the rail to the console back panel.

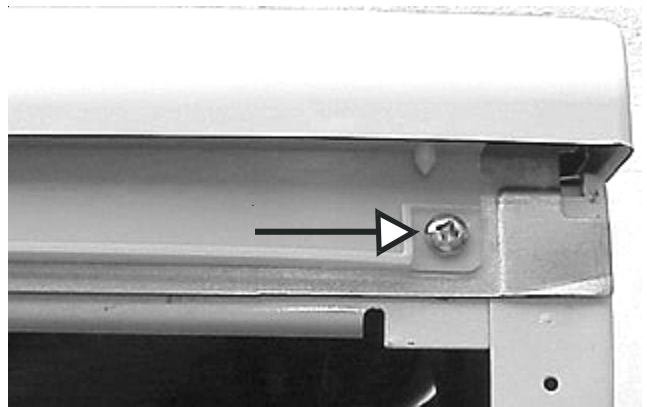
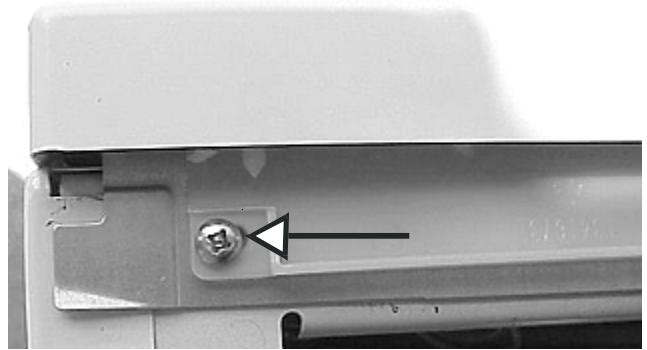

3. Lift the edge of the console and pull the rail back.

Removing the front panel:

1. Disconnect the dryer from electrical supply and remove the top panel.
2. Unplug the two harness plugs and release the ground wire.

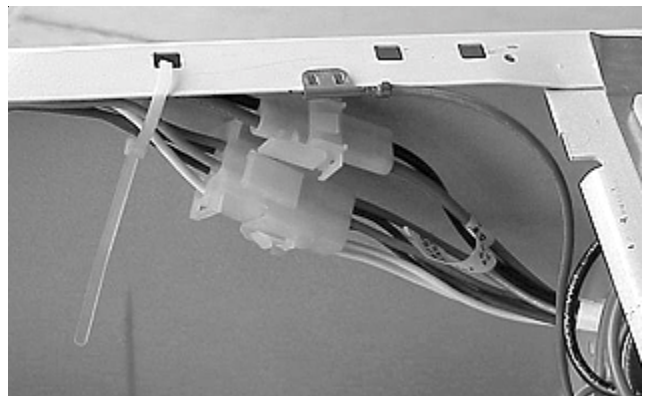

3. Remove the 2 screws holding the drip rail to the console and side panel.
4. Remove one screw from each side, located about 6 inches down from the top, that holds the front panel to the side panel.
4. Release the clips holding the front panel to the side panels and gently lean the panel forward.

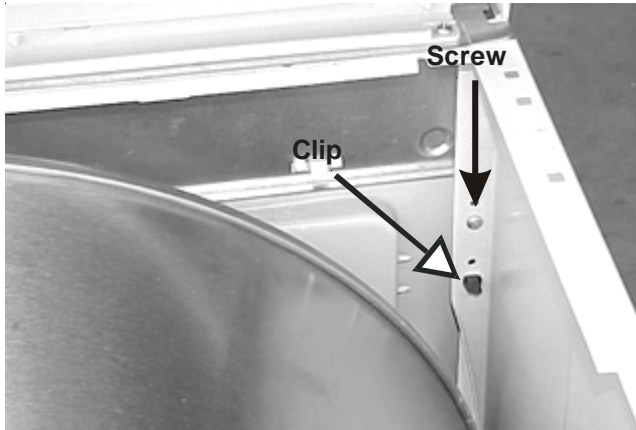

2. Unplug the wiring from the control.

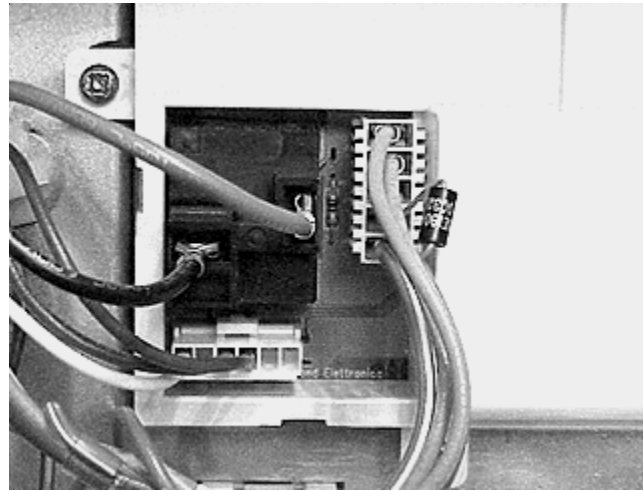

Note: The two wires going to relay RL 2 have locking terminals that can be released with a small screwdriver.

5. Lift the panel off the bottom clips.

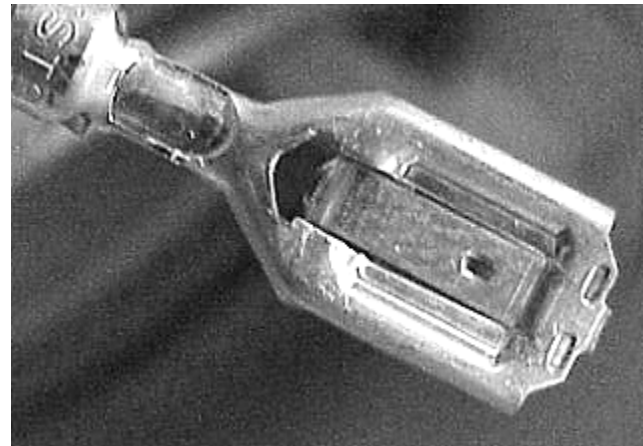
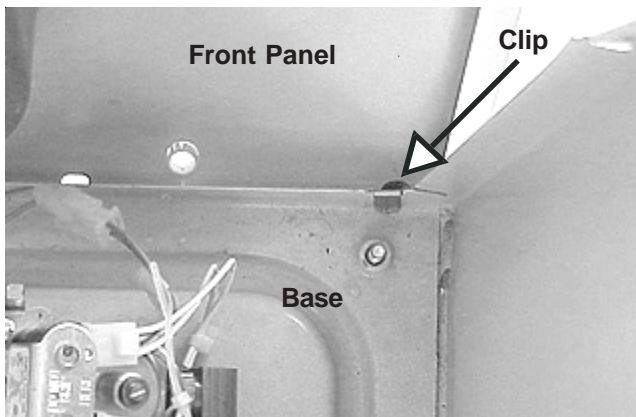

Removing the electronic control and display:

1. Disconnect the dryer from electrical supply and remove the front panel.

3. Release the ribbon by unlocking the ribbon connector by lifting connector about 1/4 of an inch away from the board.

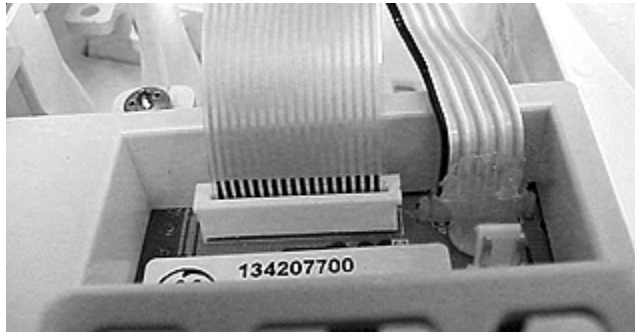

Connect in the locked position.

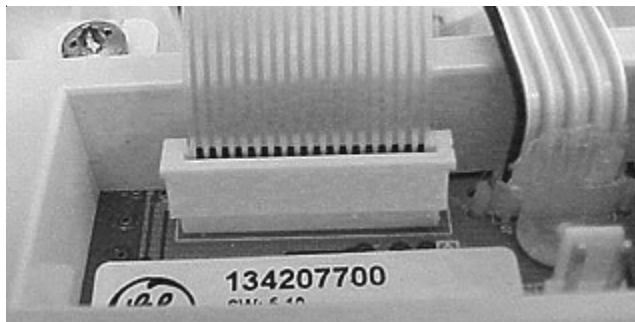

Connect in the unlocked position.

4. Remove the 4 screws holding the board to the console, the 2 screws holding the display to the console and lift the board and display off.

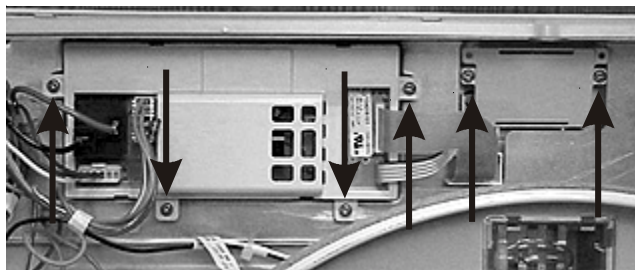

Removing the console:

1. Disconnect the dryer from electrical supply, and remove the front panel.

2. Disconnect the wires from the door switch and unplug the harness for the sensor bars.

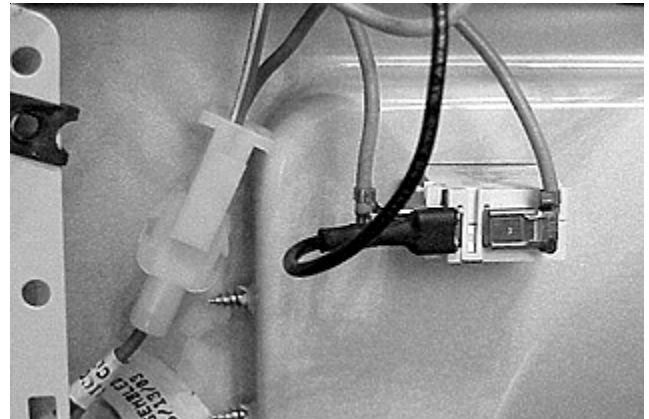

3. If the dryer is equipped with a drum light, disconnect the two wires from the drum light.

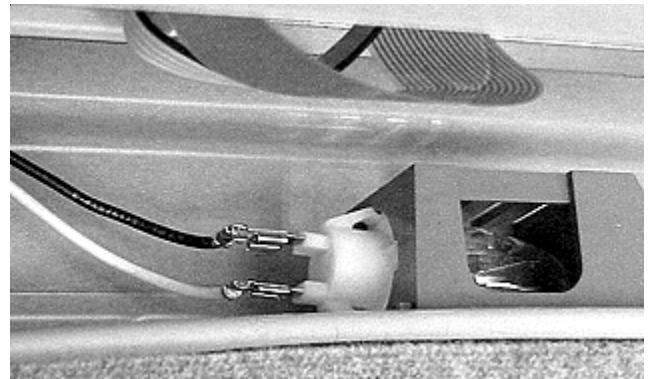

4. Disconnect the ribbon from the control board.

5. Remove the 2 screws, one in each corner, holding the console to the front panel and lift the console up.

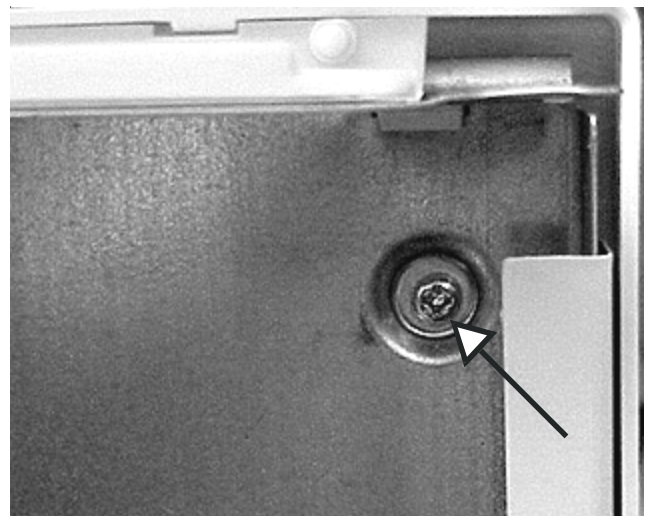

Removing the console front panel with touch pad:

1. Disconnect the dryer from electrical supply, and remove the front panel.
2. Remove the console from the front panel and the drip rail from the console.
3. Disconnect the ribbon from the control board.
4. Remove the control board and display.
5. Release the 4 lower locking tabs across the back of the console holding the plastic front panel to the metal mounting panel.

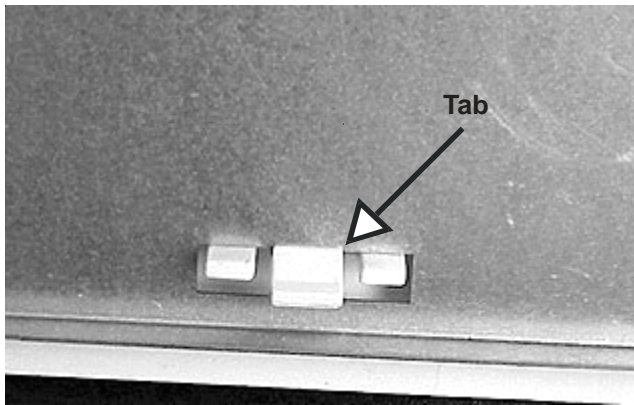

6. Pull out on the bottom of the metal panel and slide the metal panel down to release the top 3 top tabs.

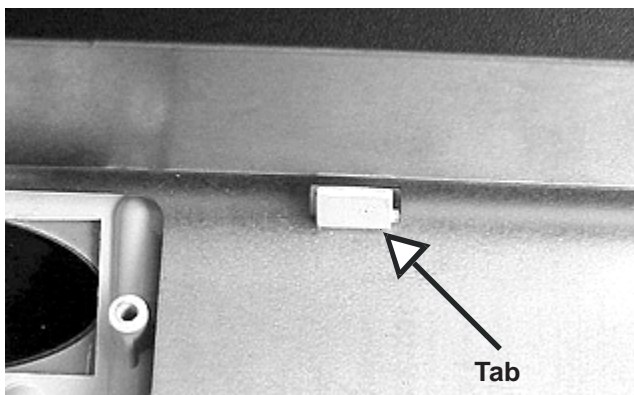

Removing the door:

1. Open the door and remove the four screws holding the door to the hinges.

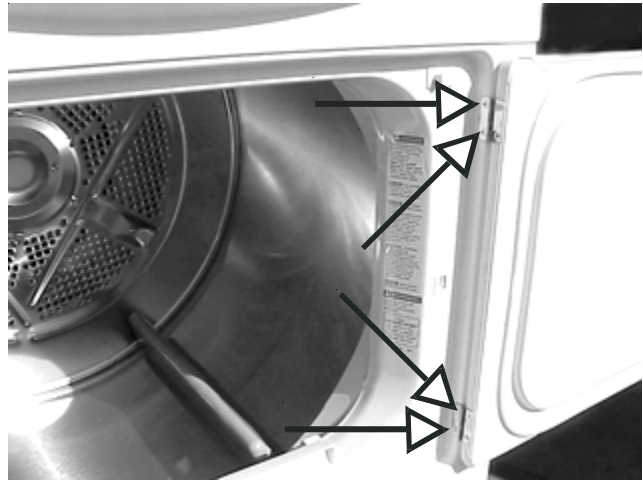

Separating the door panel:

1. Remove the door.
2. Remove the two screws from the end and two screws from the bottom.

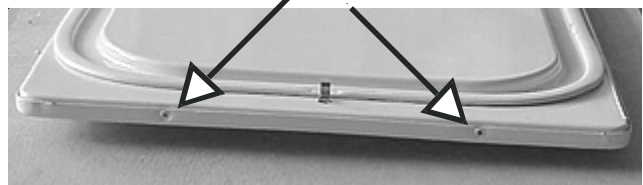

3. Lift the inner panel off the outer panel.

Removing the door seal:

1. The door seal is fasten to the inner door liner by expandable tabs pushed through slots in the liner.

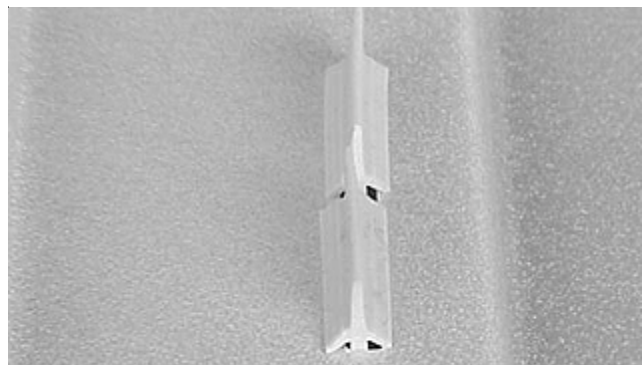

2. If the seal is to be replaced open the door and pull the seal from the liner. If the seal is to be reused, separate the panels and use a small screwdriver to push the tabs through the liner.

Removing the door handle:

1. Separate the panel and release the tabs holding the handle in outer panel.

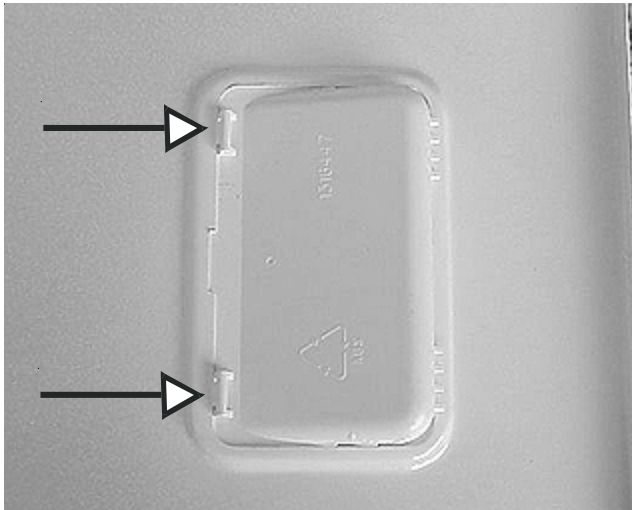

Removing the door strike:

1. Separate the panel, squeeze the ends of the strike and push it through the inner panel.

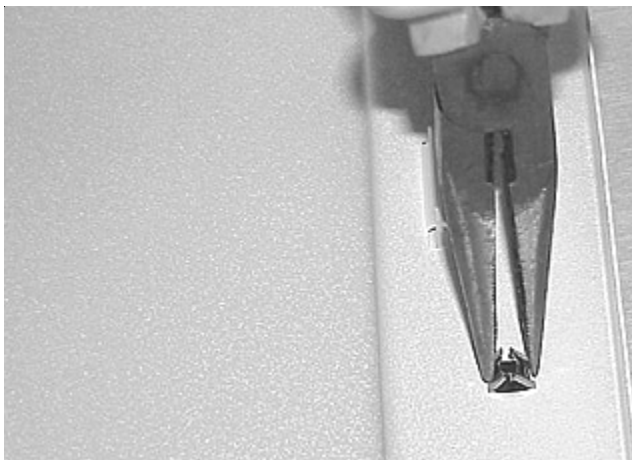

Removing the door catch:

1. Disconnect the dryer from electrical supply, open the door and remove the top panel.

2. Push up and forward and down and forward on the rear of the catch moving the catch forward until the metal tabs hit the front panel.
3. Release the metal tabs with a small screwdriver and push the catch out the front.

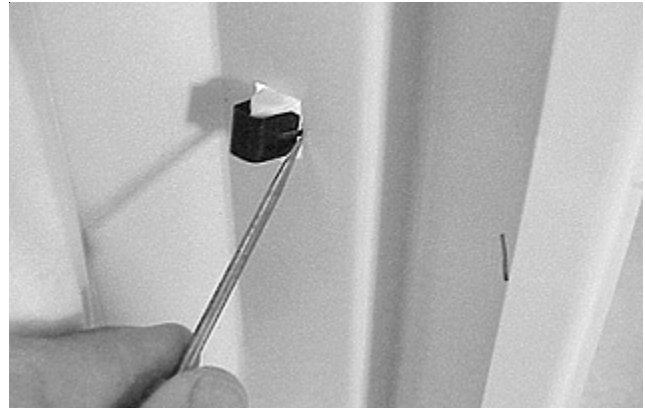

Removing the door hinge:

1. Open and support the door.
2. Remove the two screws holding the hinge to the front panel and the two screws holding the hinge to the door.

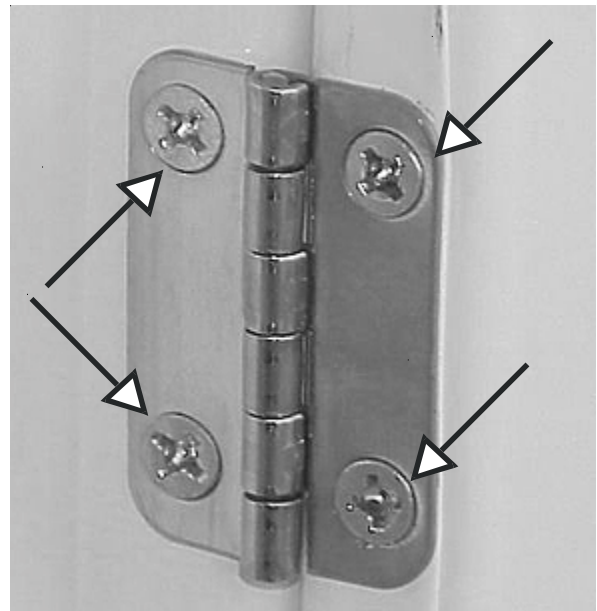

Removing the door switch:

1. Disconnect the dryer from electrical supply, open the door and remove the top.

2. Disconnect the wires from the door switch.
3. Squeeze the release tabs on the ends of the switch and push it out the front.

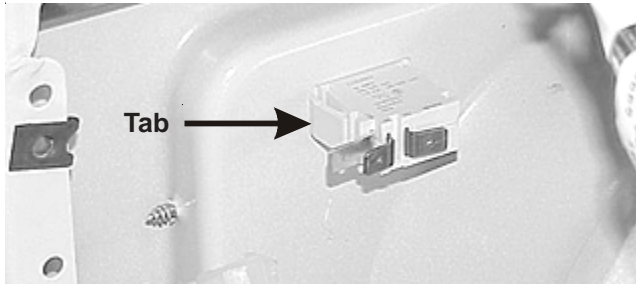

Removing the sensor bars:

1. Disconnect the dryer from electrical supply.
2. Open the dryer door and remove the lint screen.
3. Remove the two screws holding the vent grill to the front panel.



4. Pull the grill into the drum and disconnect the wires.

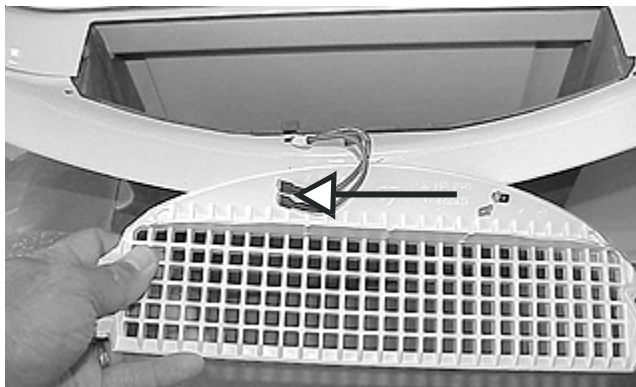

Replacing the drum light bulb:

1. Open the dryer door, release the clip holding the light shield by pushing up, and unscrew the bulb.

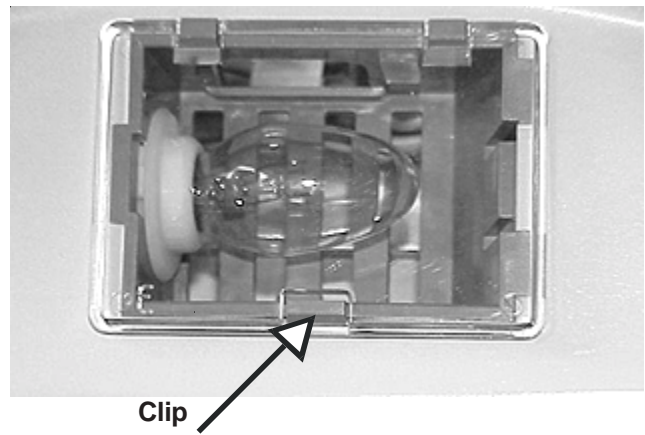

Replacing the drum light housing:

1. Disconnect the dryer from electrical supply.
2. Remove the top, lean the top of the front panel forward and disconnect the wires from the light socket.
3. Push in to release the tab at the end of the housing and push the housing into the drum.

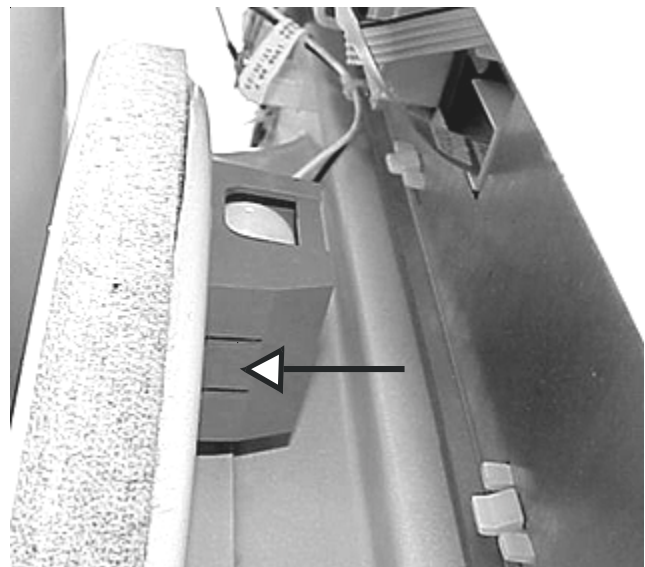

Replacing the drum light socket:

1. Disconnect the dryer from electrical supply.

2. Remove the top, lean the top of the front panel forward and disconnect the wires from the light socket.
3. Remove the light bulb, squeeze the tabs on the side of the socket and push the socket into the housing.



Replacing the felt seal:

1. Disconnect the dryer from electrical supply.
2. Remove the front panel.
3. The felt seal is a two piece seal that is glued to front panel rim that the drum rides on.
4. To replace the seal pull the seal off and glue the replacement to the rim.



Replacing the foam seal:

1. Disconnect the dryer from electrical supply.
2. Remove the front panel.
3. The foam seal is glued to front panel duct and seals between the front panel duct and the blower.
4. To replace the seal pull the seal off and glue the replacement to the duct.

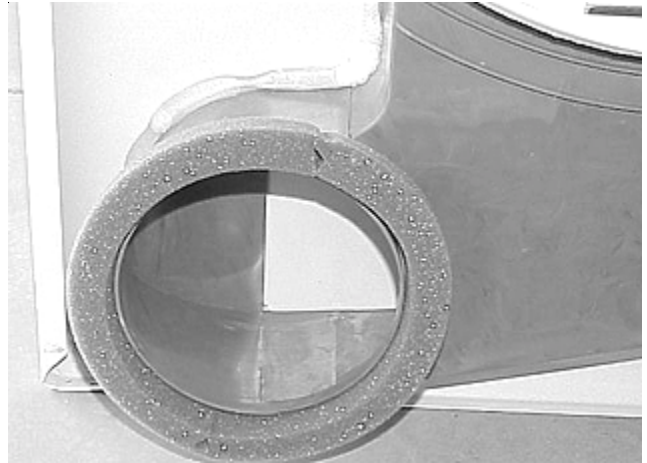

Removing the rear access panel:

1. Remove the two screws holding the access panel to the rear panel and swing the left side of the vent out to disengage the tabs.

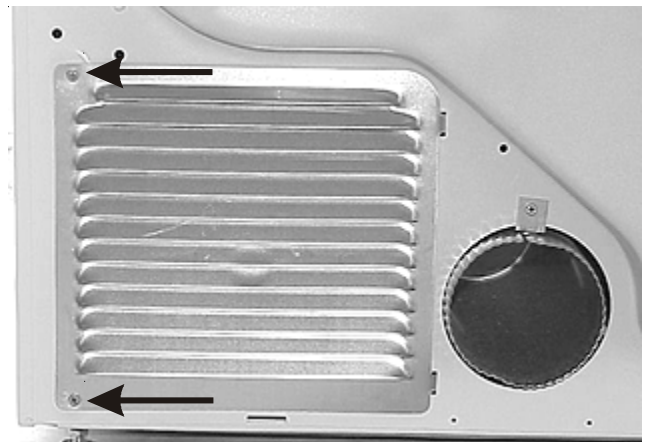

Releasing the dryer belt:

1. Remove the access panel.

2. Push the idler pulley to the right and slip the belt off the motor pulley.

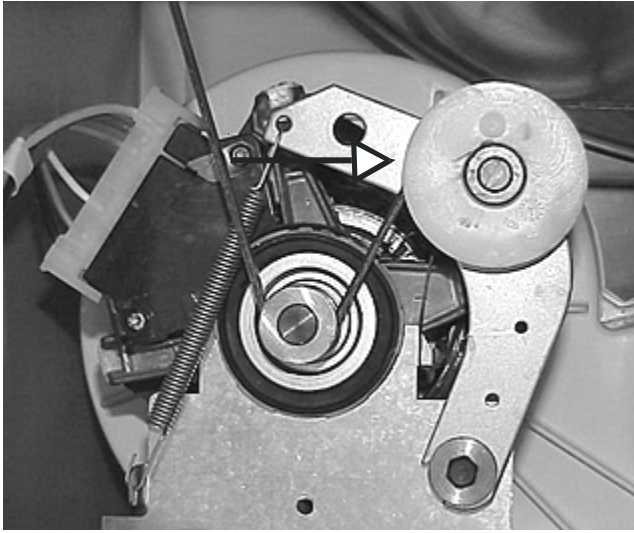

4. Use the belt to raise rear of the drum to release the ball from the hitch and move the drum out the front.



Removing the vane from the drum:

1. Disconnect the dryer from electrical supply.
2. Open the door, remove the top panel, the two screws holding the vane to the drum and drop the vane into the drum.

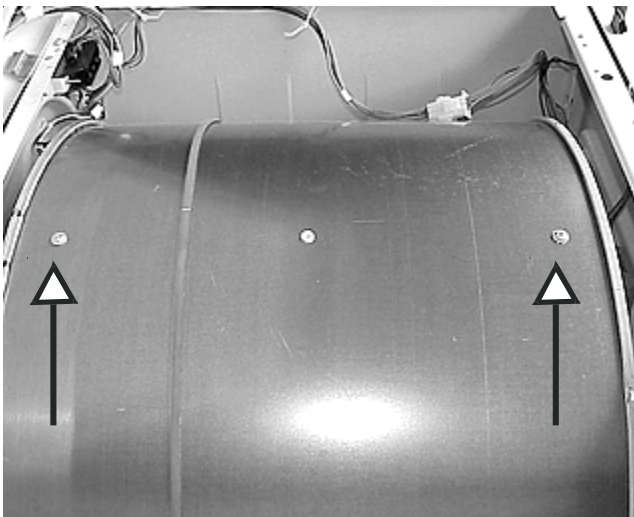

Removing the belt:

1. Disconnect the dryer from electrical supply.
2. Remove the top and the front panels.
3. Release the belt from the motor.
4. From the front, slightly raise the front of the drum and slide the belt off.

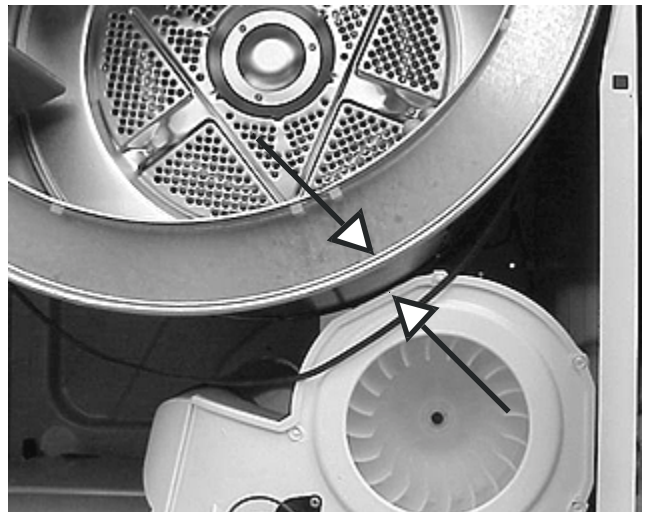

Removing the drum:

1. Disconnect the dryer from electrical supply.
2. Remove the top and the front panels.
3. Release the belt from the motor.

Removing the ball hitch from the drum:

1. Disconnect the dryer from electrical supply and remove the drum.
2. Remove the three screws from inside the drum holding the ball to the drum.

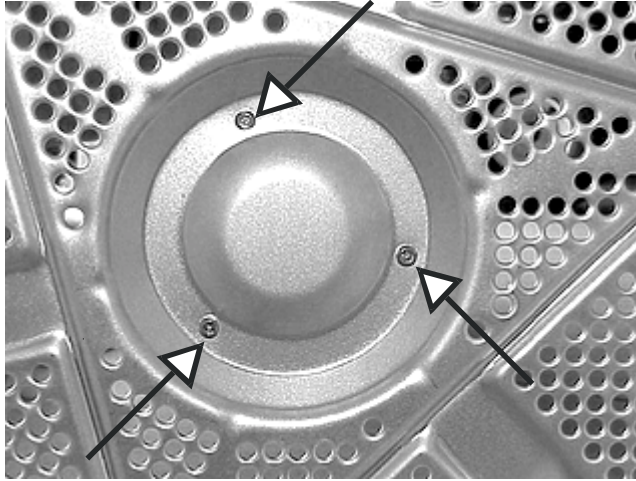

Removing the teflon glides:

1. Disconnect the dryer from electrical supply and remove the front panel.
2. Squeeze the tabs to release the glides.

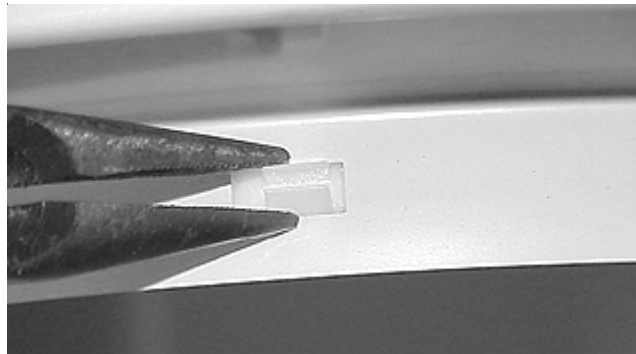

Removing the drum heat shield: (Electric dryers)

1. Disconnect the dryer from electrical supply and remove the drum.
2. Remove the three screws holding the shield to the rear of the drum.

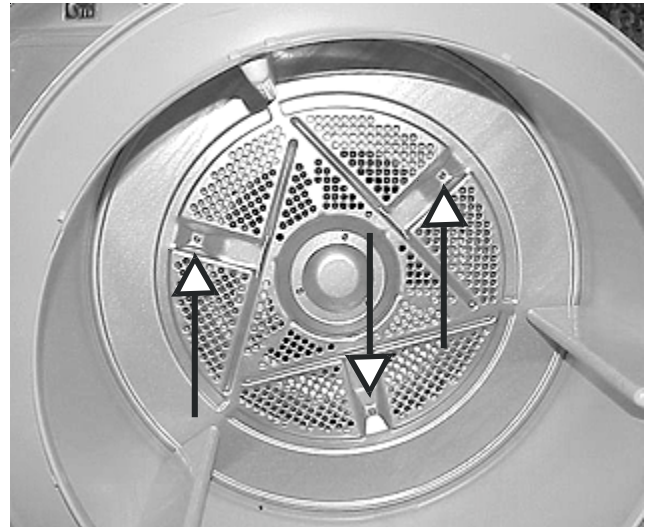

Removing the hitch:

1. Disconnect the dryer from electrical supply and remove the drum.
2. Using a 5/16" nut driver remove the two screws holding the hitch to the rear panel while holding the large tinnerman clip from the rear of the dryer.

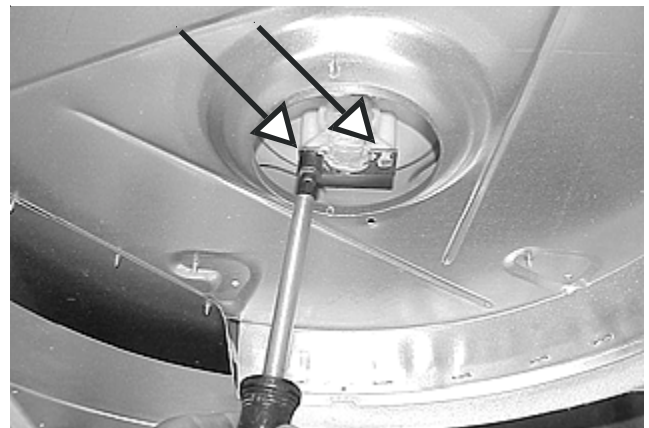

Note: Do not lose the grounding ball or the tinnerman mounting clip from the rear of the dryer.

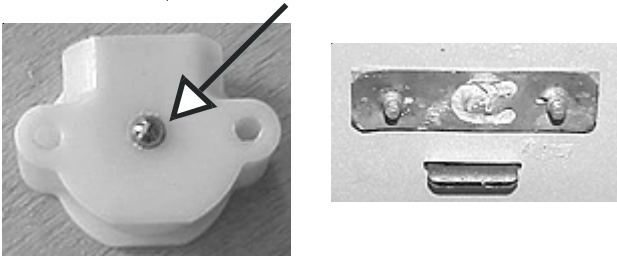

Removing the high limit thermostat:

1. Disconnect the dryer from electrical supply and remove the top panel.
2. Disconnect the two wires and remove the two screws holding thermostat to the heating element assembly.

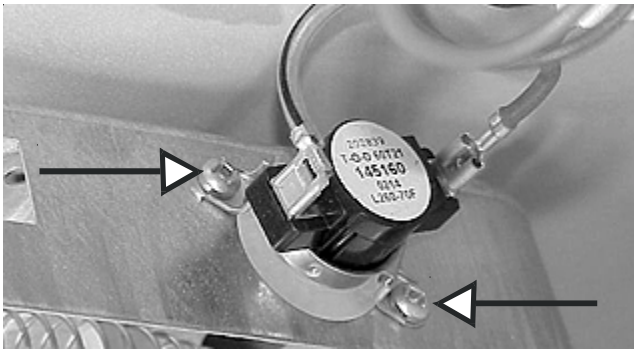

Removing the thermal limiter: (Electric dryers)

1. Disconnect the dryer from electrical supply and remove the top panel.
2. Disconnect the two wires and remove the two screws holding limiter to the rear panel.

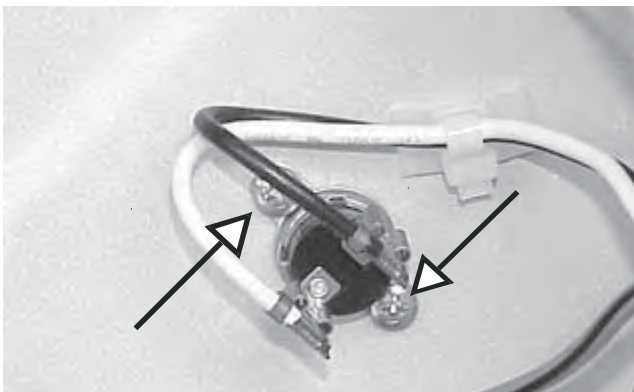

Removing the heating element assembly: (Electric dryers)

1. Disconnect the dryer from electrical supply and remove the drum.
2. Disconnect the two wires from the heating element.
3. Remove the high limit thermostat.

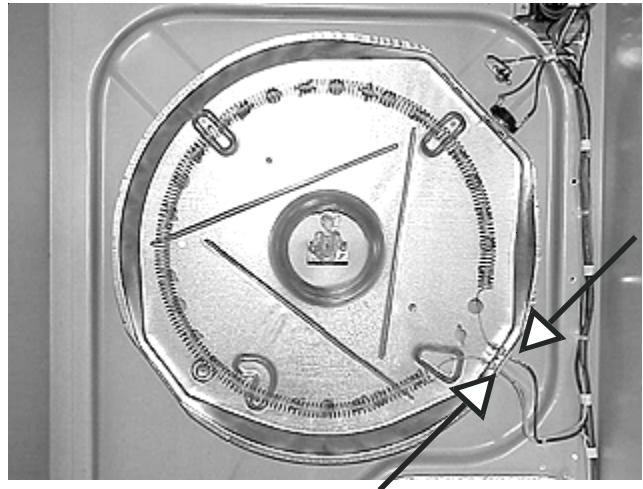

4. From the rear of the dryer remove the four screws securing the heating element assembly to the rear of the cabinet.

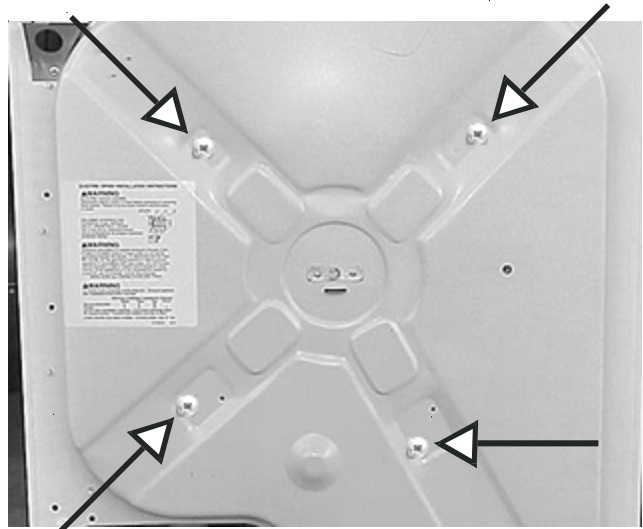

Removing the control thermistor:

1. Disconnect the dryer from electrical supply and remove the front panel.

2. Disconnect the wires from the thermistor and remove the two screws holding the thermistor to the blower housing.

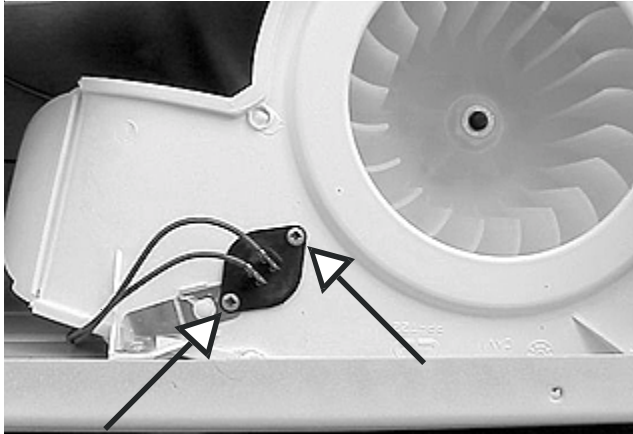

4. Remove two screws holding the housing to the dryer base.

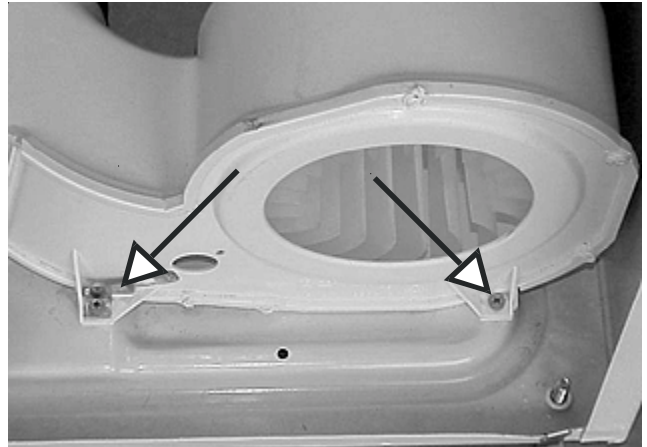

Removing the blower housing and fan blade:

1. Disconnect the dryer from electrical supply and remove the drum.
2. Remove the control thermistor.
3. Using a 7/8" socket turn the fan blade clockwise while holding the motor shaft to remove the blade from the motor shaft.

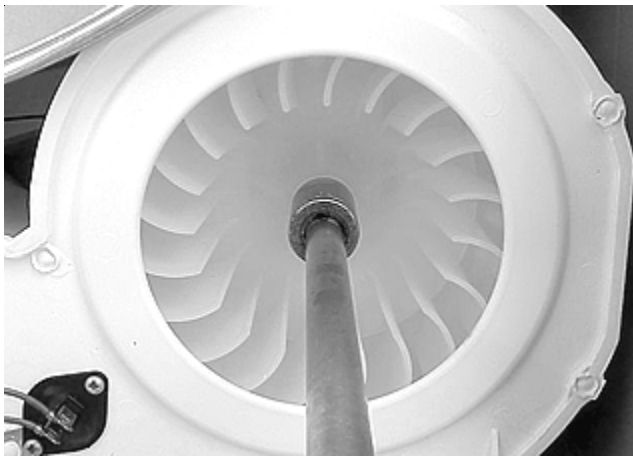

5. Remove the front motor lock by inserting a screwdriver at the rear of the housing to release the housing from the motor.



6. Raise the front of the motor and pull the housing forward.

Removing the idler pulley:

1. Disconnect the dryer from electrical supply and remove the rear access panel.
2. Release the belt from the motor pulley and slide the idler pulley off.

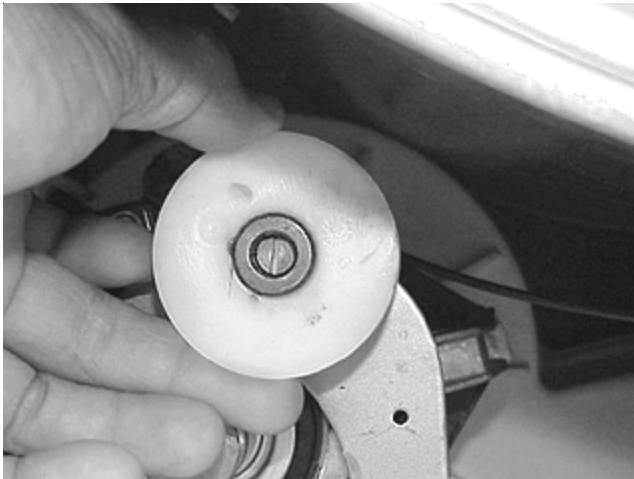

Removing the idler pulley assembly:

1. Disconnect the dryer from electrical supply and remove the rear access panel.
2. Release the belt from the motor pulley.
3. Release the idler spring from the motor and lift the assembly off the motor.

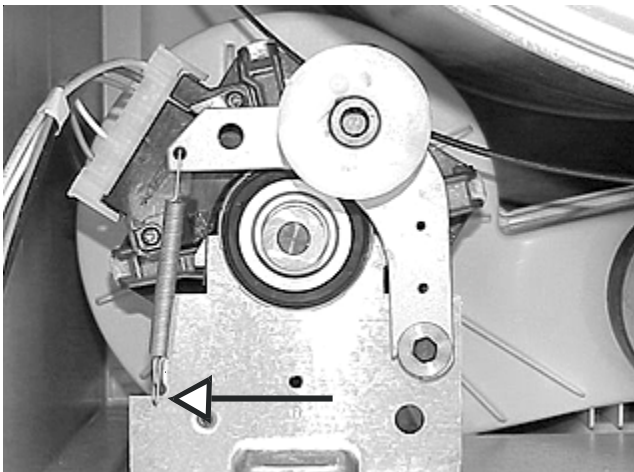

Removing the drive motor:

1. Disconnect the dryer from electrical supply and remove the drum.

2. Unplug the harness from the motor and remove the idler assembly.
3. Unscrew the blower wheel from motor shaft.
4. Release the front motor lock from the blower housing.
5. Release the spring hold down on the rear of the motor and lift the motor out.

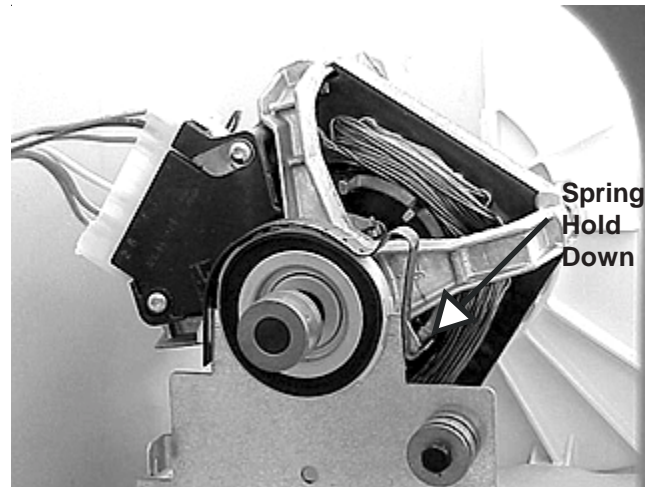

Removing the burner: (Gas dryers)

1. Disconnect the dryer from electrical supply and remove the front panel.
2. Unplug the igniter, remove the two screws holding the burner to the valve assembly bracket, and slide the burner into the combustion chamber to release burner from the valve.

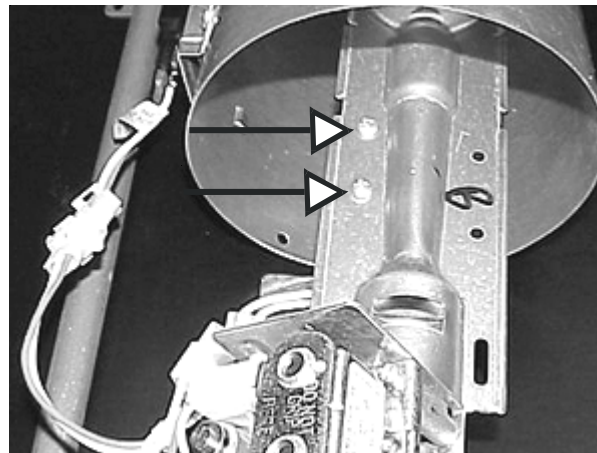

Removing the igniter: (Gas dryers)

1. Disconnect the dryer from electrical supply and unplug the igniter harness.

- The igniter is held to the burner mounting bracket by a screw and a tab. Remove the screw and lift the igniter up to release the tab, then slide the igniter forward.

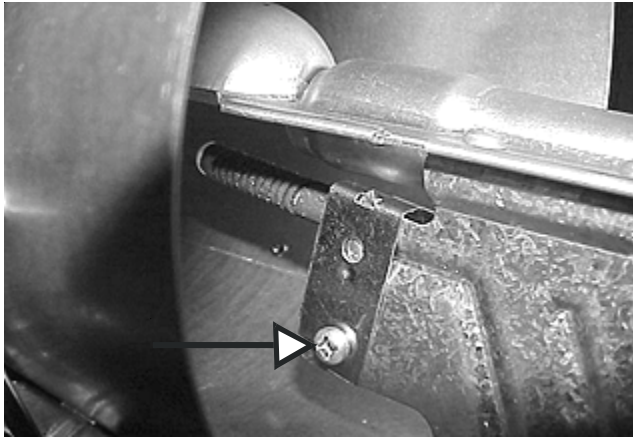

- Remove the one screw securing the gas valve assembly bracket to the base, slide the gas valve assembly forward and lift the gas valve assembly out.

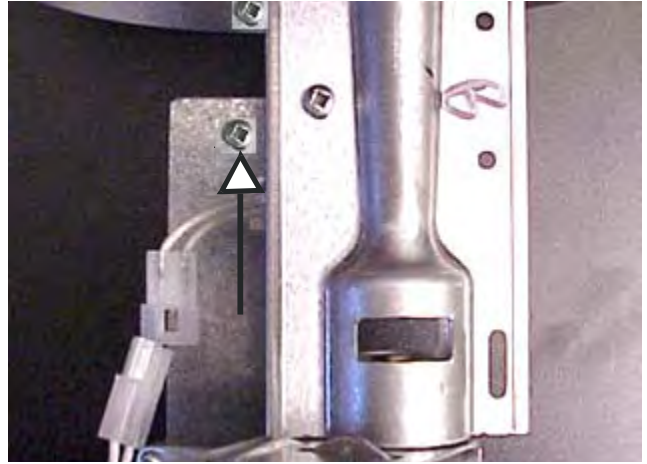

Removing the gas valve assembly: (Gas dryers)

- Turn the gas supply off and disconnect the dryer from electrical supply
- Unplug the wires from the valves
- Using a 15/16" open end wrench, disconnect the manifold pipe from the valve.

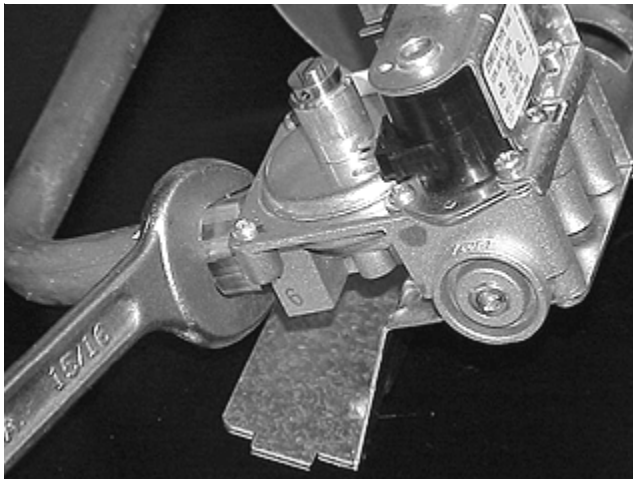

- Remove the two screws holding the valve to the bracket.

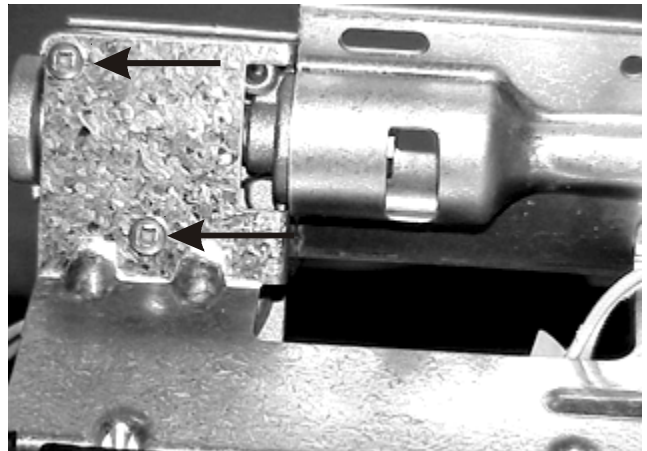

Removing the gas valve coils: (Gas dryers)

- Disconnect the dryer from electrical supply and remove the front panel.
- Disconnect the wires from the coils, remove the two screws holding the coil bracket to the valve base and lift the coils off.



Removing the sensor: (Gas dryers)

1. Disconnect the dryer from electrical supply and remove the front panel.
2. Disconnect the two wires from the sensor.
3. Remove the one screw holding the sensor to the combustion chamber.

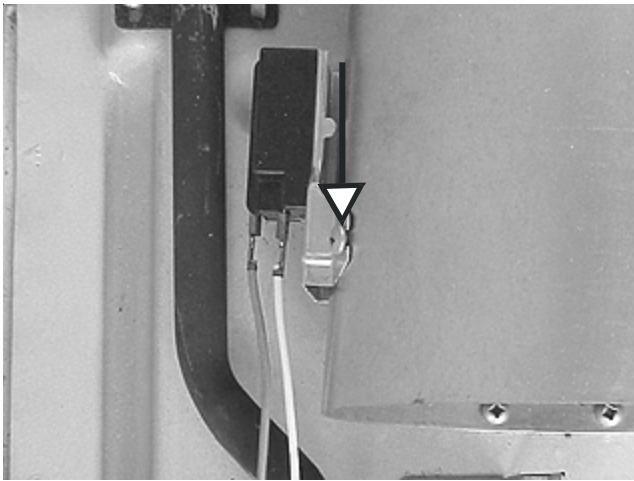

Removing the combustion chamber: (Gas dryers)

1. Disconnect the dryer from electrical supply, remove the sensor and gas valve assembly.
2. Remove the two screws holding the combustion chamber to the base, raise the end and pull the chamber out of the duct.

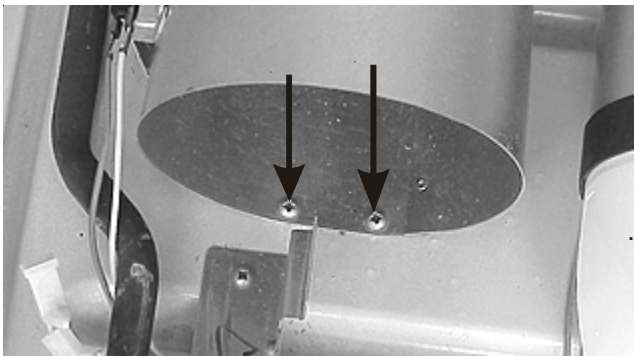

Removing the duct and heat shield: (Gas dryers)

1. Disconnect the dryer from electrical supply, remove the drum.
2. Remove four screws holding the heat shield to the rear panel.



3. Lift the shield and duct out of the dryer and remove the three screws holding duct to the heat shield.

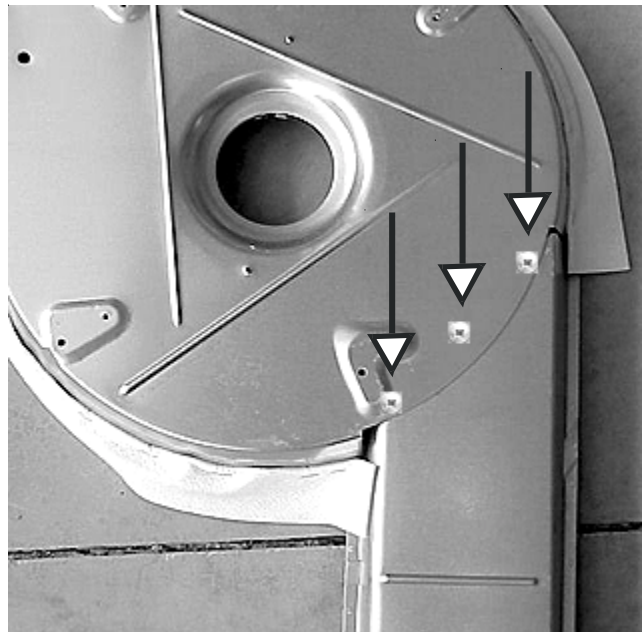

Removing the manifold pipe: (Gas dryers)

1. Disconnect the dryer from electrical supply.

2. Turn the gas supply off and disconnect the gas supply from the dryer.
3. Remove dryer front panel.
4. Using a 15/16" open end wrench disconnect manifold pipe from the valve.



5. Remove the two screws holding the manifold pipe to the base and lift the pipe out.

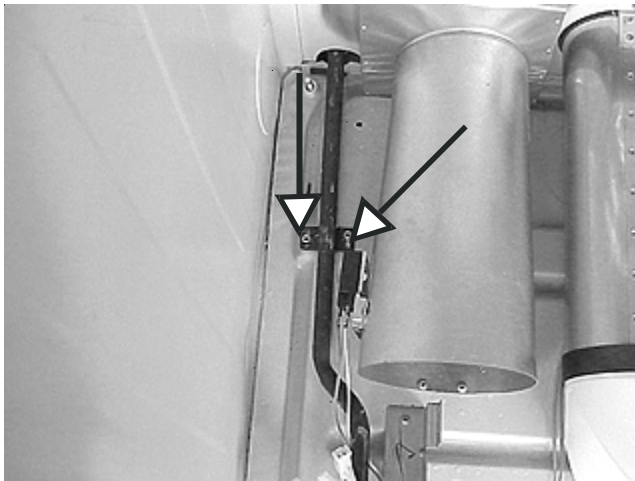

Removing the vent pipe: (Gas dryers)

1. Remove the one screw holding vent to the rear panel and pull the vent pipe out the back.

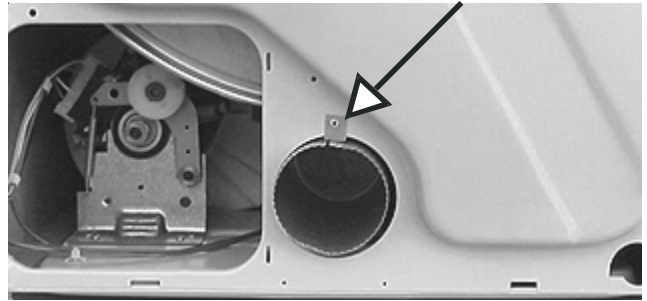

Removing the gasket between the vent pipe and blower housing : (Gas dryers)

1. Disconnect the dryer from electrical supply.
2. Remove front panel and slide the gasket completely on to the vent pipe.
3. Remove the vent pipe out the rear of the dryer and remove the gasket from the vent pipe.

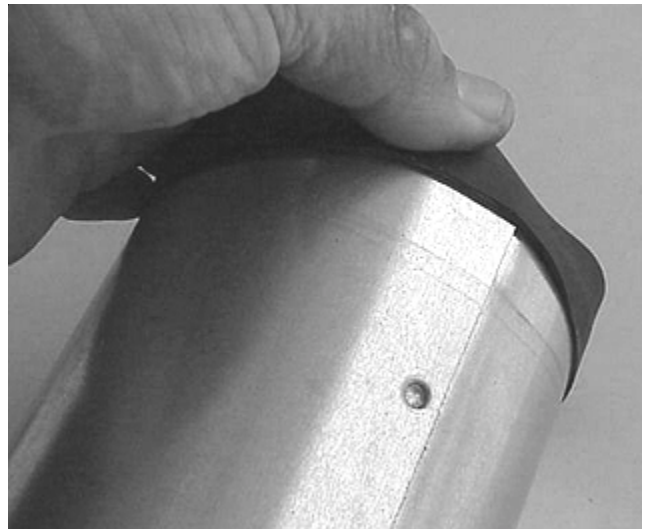

4. When reinstalling, install the gasket on the vent pipe, install the vent pipe in the dryer and slide half of the gasket on to the blower housing from the front of the dryer.

