

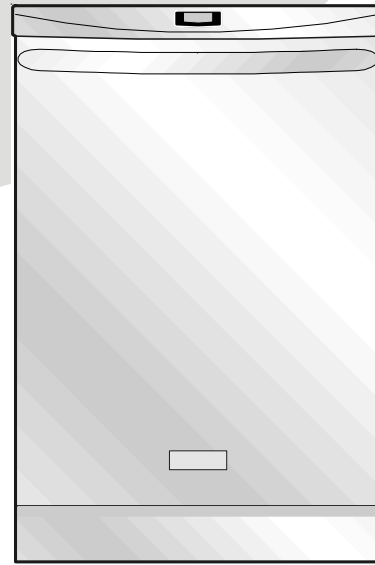



Dishwasher Service Manual

Fully Integrated Direct Feed
Model Dishwashers



<i>Frigidaire</i> Built for Generations		
Gibson Backed by the Platinum Advantage [™] Warranty. <i>Built to Deserve it.</i>	TAPPAN For The Love Of Cooking [™]	 Kelvinator [®] Sensible, Dependable, Affordable.
 White-Westinghouse [®] There's Extra Value In Everything We Do.		

SAFE SERVICING PRACTICES - ALL APPLIANCES

To avoid personal injury and/or property damage, it is important that **Safe Servicing Practices** be observed. The following are some limited examples of safe practices:

1. **DO NOT** attempt a product repair if you have any doubts as to your ability to complete it in a safe and satisfactory manner.
2. Before servicing or moving an appliance:
 - Remove the power cord from the electrical outlet, trip the circuit breaker to the OFF position, or remove the fuse.
 - Turn off the gas supply.
 - Turn off the water supply.
3. Never interfere with the proper operation of any safety device.
4. **USE ONLY REPLACEMENT PARTS CATALOGED FOR THIS APPLIANCE. SUBSTITUTIONS MAY DEFEAT COMPLIANCE WITH SAFETY STANDARDS SET FOR HOME APPLIANCES.**
5. **GROUNDING:** The standard color coding for safety ground wires is **GREEN**, or **GREEN** with **YELLOW STRIPES**. Ground leads are not to be used as current carrying conductors. It is **EXTREMELY** important that the service technician reestablish all safety grounds prior to completion of service. Failure to do so will create a hazard.
6. Prior to returning the product to service, ensure that:
 - All electrical connections are correct and secure
 - All electrical leads are properly dressed and secured away from sharp edges, high-temperature components, and moving parts
 - All non-insulated electrical terminals, connectors, heaters, etc. are adequately spaced away from all metal parts and panels
 - All safety grounds (both internal and external) are correctly and securely connected
 - All panels are properly and securely reassembled

ATTENTION!!!

This service manual is intended for use by persons having electrical and mechanical training and a level of knowledge of these subjects generally considered acceptable in the appliance repair trade. Electrolux Home Products, Inc. cannot be responsible, nor assume any liability, for injury or damage of any kind arising from the use of this manual.

TABLE OF CONTENTS

Safe Servicing Practices	2
The Design and Operation of the Fully Integrated Dishwasher	5
PLD4555RFC	5
PLD4375RFC	5
LEDB500FEE	5
Cycle Selections	6
Ultimate Scrub	6
Maxx Clean	6
Speed Clean	6
Normal Wash	6
China/Crystal	6
Eco Wash	6
Top Rack, Glasses and Party Glasses	6
Rinse Only	6
Favorite Cycle	6
Option Selections	7
Wash Pressure	7
Wash Temperature	7
Sanitize Rinse	7
Dry	7
Delay Start	7
Control Lock	8
Digital Display	8
Status Indicators	8
WASHING	8
DRYING	8
CLEAN	8
SANITIZE	8
Rinse Agent LOW	8
Wash System	8
The Alternating Wash System	9
Part in the Wash System	10
Wash Pump	10
Stainless Steel Filter	10
Lower Spray Arm	11
Center Spray Arm	11
Upper Spray Arm	11
Drain Pump	11
Drying System	12
Fan/Vent Assembly	12
Heater	13
Door Baffles	13
Dispensing System	13
Dispenser Operation	13
Door Latch Assembly	14
Fill System	14
Door Hinge and Spring	14

The Control System -----	15
Soil Sensing -----	15
Temperature Controls -----	15
Service Tests -----	16
Water Temperature Test -----	16
To Activate the Water Temperature Test -----	16
Water/Service Test -----	16
To Start the Test -----	16
To Exit the Water/Service Test -----	16
Chart for the Water/Service Test -----	17
Relay/Triac and Sensor Test -----	17-18
Control Codes -----	19
Disassembly and Service -----	20
Safety Precautions -----	20
Control Panel -----	20
Electronic Control -----	20
Display -----	20
Door Latch -----	21
Door Strike -----	21
Detergent/Rinse Aid Dispenser -----	21
Door Hinge -----	21
Door Seal -----	22
Bottom Door Seal -----	22
Upper Rack -----	22
Tub Roller Assembly -----	22
Center Spray Arm -----	22
Upper Spray Arm -----	22
Lower Spray Arm, Spray Arm Support and Filter -----	23
Heating Element -----	23
Float Switch and Mount Bracket -----	23
Water Valve -----	23
Drain Pump -----	24
Replacing the Drain Pump -----	24
Pump and Motor Assembly -----	24
Remove motor from sump -----	24
Delivery Tube -----	25
Vent and Fan Assembly -----	25
Exploded Views -----	26-34
Control Panel -----	26
Door - model LEDB500FEE0 -----	27
Door - models PLD4375RFC0 & PLD4555RFC0 -----	28
Tub -----	29
Motor & Pump -----	30
Frame -----	31
Racks - model LEDB500FEE0 -----	32
Racks - model PLD4375RFC0 -----	33
Racks - model PLD4555RFC0 -----	34
Service Data Sheet -----	35-36

Fully Integrated Direct Feed Model Dishwashers



PLD4555RFC

Figure 1

The Design and Operation of the Fully Intergraded Dishwasher.

The fully integrated control places all cycle selection and options on top of the console out of sight with the door closed. With the controls under the counter top while in operation, the cycle selection needs to be accomplished with the door opened. First select a wash cycle and any options, then press the Start/Cancel pad or a Delayed Start pad and close the door the cycle begins. A display mounted in the front of the console shows the time remaining of the delay or the time remaining in the cycle. While in operation, the dishwasher control monitors the progress of the cycle to determine if changes need to be made to improve the cycle performance. Changes to the cycle can start as early as the first fill, if food soils in the water deems it necessary. If the user wishes to make a change to the cycle, it needs to be done before the completion of the first fill. After that time any changes to a wash cycle will require a Cancel/Drain before a new wash cycle can be selected. While in operation, the control monitors all aspects of the cycle with the use of sensors mounted in the sump. These sensors enable the control to adjust the length of the cycle based on soil level and water temperature and are made as needed.

As stated earlier, a wash cycle can not be changed after the first fill without a Cancel/Drain, options to the wash cycle can be changed at any time up to the point they are to be applied. If at any time after the cycle has been started, the door is opened the unit will stop, by closing the door the operations will resume without pressing the Start/Cancel pad. If a cycle needs to be terminated after the first fill has started touching the Start/Cancel pad once sends the unit into a Cancel/Drain for 90 seconds, this terminates this selection. If while in a Cancel/Drain the Start/Cancel pad is pressed a second time the drain action stops immediately. At the completion of a wash cycle the control lights the Clean indicator; this indicator remains on until the door is opened. After the wash cycle is completed and the door opened when the Start/Cancel pad is pressed for a new load the control will repeat the previous run cycle, including all of the previously selected options.

Added to the fully integrated control, the new design offers, a new control console which is decreased in height. The vent and door latch release handle that had added to the height have been redesigned. The towel bar handle once decoration now becomes the door opening handle.

PLD4555RFC This is a 5 speed Professional model with 6 wash cycles and a Rinse only cycle. This model has preprogrammed wash pressure, water temperatures, and dry options for each of the 6 different wash cycles. The user has the option to change these setting to accommodate their desires. See Figure 1

PLD4375RFC This is a 3 speed Professional model with 6 wash cycles and a Rinse only cycle. This model has preprogrammed wash pressure, water temperatures, and dry options for each of the 6 different wash cycles.

LEDB500FEE This is a 5 speed Elements model with 5 wash cycles, a Favorite cycle, and a Rinse only cycle. This model has preprogrammed settings for motor speed, water temperature and dry for each of the wash cycles with the option to change these if the user wishes. The Favorite Cycle selection allows the user to program a wash cycle with any options to their liking, then hold this cycle in memory by pressing one pad the designed cycle is repeated.

Cycle Selections



PLD4555RFC



PLD4375RFC



LEDB500FEE

Figure 2

To better understand these different wash cycles the following are each cycle, the settings and what options are available.

Ultimate Scrub

This cycle is used for heavily soiled dishes. The control automatically selects the High speed for the wash motor, an assured water temperature of 140° in the main wash and 155° in the final rinse, and dry is a default to Sahara. All of the options are available and soil sensing will be used.

Maxx Clean

This cycle is used for heavily soiled dishes. The control automatically selects the Maxx wash speed for the wash motor, an assured water temperature of 140° in the main wash, 155° in the final rinse, and dry is default to Maxx. All of the options are available and soil sensing will be used.

Speed Clean

This cycle is used for a small dish load or lightly soiled. The control automatically selects a High / Maxx wash speed on the wash motor, an assured water temperature of 125° in the main wash and 128° in the final rinse. Only the Dry Option and Delay Start options are available. Soil sensing is used.

Normal Wash

This cycle is for normally soiled dishes. The control automatically selects the Normal speed for the wash motor, an assured water temperature of 135° in the main wash and 140° in the final rinse. All of the options are available and soil sensing will be used.

China/Crystal

This cycle is for delicate crystal or china. The control automatically selects the Delicate speed for the wash motor, an assured water temperature of 130° in both the main wash and the final rinse. Only the Air Dry and the Delay Start options are available. Soil sensing will not be used.

Eco Wash

This cycle is for lightly soiled dishes. The control automatically selects the Normal speed for the wash motor, an assured water temperature of 135° in the main wash and 140° in the final rinse. All Wash Pressures, Dry Options, and Delay Start options are available. The Wash Temperature option is not available and soil sensing will not be used.

Top Rack, Glasses, or Party Glasses

This cycle is used for small loads of glassware or cups. The control automatically selects the Normal speed for the wash motor only an assured water temperature of 135° is set for the final rinse. The water temperature options, dry options, and Delay Start are available. Soil sensing will not be used.

Rinse Only

This cycle is intended to rinse dishes that will be washed at a later time. There are no options available with the exception of a Delay Start.

Favorite Cycle

This is a cycle programmed by the user and gives them a short cut to a cycle they use frequently. To program the Favorite Cycle make the selection of a wash cycle and all of the desired options, press and hold the Favorite Cycle pad for three seconds. Once the Favorite Cycle has been set the following indicators will flash Time remaining, Favorite Cycle, the user's selected cycle and all options selected. These lights will flash for 2 seconds. The Favorite cycle can now be set as a wash cycle with the Start/Cancel pad.

Option Selections

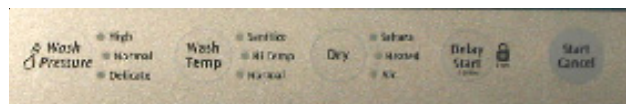

PLD4555RFC



PLD4375RFC

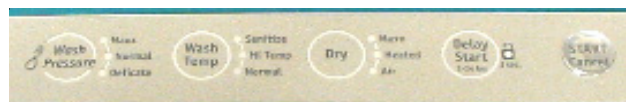

LEDB500FEE

Figure 3

Option selections allow the user flexibility to alter a wash cycle to their desires. These options are the speed of the wash motor this will increase water pressure sprayed on the load, the temperature of water in both the main wash and final rinse segment of a cycle, the dry can be a no heat dry or on some models the heated dry can actually be extended for a longer time. This section covers these and a delay start option.

Wash Pressure

This option allows the user to raise or lower the speed of the wash motor which increases or decreases the pressure of the water used to clean the dishes. The control will not allow this change in all cycles because of the intent of the cycle. This change in water pressure will effect all of the washes and rinses in this selected cycle.

Depending on model, the option could read either **“High” or “Maxx” speed**. This selection will substitute the speed of the motor to 3400 rpm when spraying from the lower spray arm and 3200 rpm from the upper and center arms. This overrides the variable speed function of the selected cycle.

Delicate Pressure limits all wash and rinse speeds to 2800 rpm only for the selected cycle.

Wash Temperature

This option allows for the selection of a high temperature wash in select cycles. The high temperature wash occurs at the end of the main wash segment of the cycle.

The display will flash an HO on models so equipped. This option will increase the water temperature to 140°. There is a time override for this option of not more than 10 minutes.

Sanitize Rinse

The Sanitize rinse increases the final rinse segment to a temperature of 155° on select wash cycles. On models PLD4555RFC and LRDB500FEE when the sanitize rinse option is selected this selects the High Temp wash as well, for that reason, both the Sanitize and Hi temp wash indicators will light. On other models, this is a separate option. There can be up to 30 minutes delay for the Sanitize rinse when selected. On models with a display, an HO will flash during this delay period. Once the wash cycle is completed, the Sanitize light and the Clean light are light and remain on until the door is opened. If the 155° was not reached in the allotted time, the Sanitize light will not come on informing the user the criteria for this setting was not met.

Dry

This option, on all models, can disable the heating element which gives only an air dry. There is an active vent and fan assembly located in the top right back corner of the tub that will be activated at the end of all wash cycles. On select models, the **Dry** option also offers a Max or a Sahara dry, this setting lengths the dry cycle by 20 minutes to insure a dry load. If when the dishwasher is in the dry cycle the door is opened and stays open for more than one minute the remainder of the dry cycle will cancel out.

Delay Start

This option allows for a wash cycle to be programmed into the control and the start delayed for a set number of hours. A cycle can be delayed from 1 to 24 hours in 1 hour increments. To set a Delay Start a wash cycle with options is selected followed by pressing the Delay Start pad. Each time the Delay Start pad is pressed in 3 second intervals the number of hours to delay will increase by one hour up to 24 hours. Once the delay begins, time is decreased in one hour segments until one hour remains, then the count down changes to minutes. After the count down starts pressing the Start/Cancel pad will have no effect on the delay start, if the Start/Cancel pad is a second time in succession this will cancel the delay and start the selected cycle.

Control Lock

The control lock disables the keypad so that the settings entered into the control can not be changed. To activate the control lock press and hold the Delay Start pad for 3 seconds with the dishwasher door closed. The Control Lock indicator will illuminate when the lock is set. To remove the control lock press and hold the Delay Start pad for 3 seconds until the light goes out. If the control lock is used, it should be turned off after the cycle is completed and before the door is opened.

If the control lock was used and not turned off before the dishwasher door is opened the light will go out with the control still locked, resulting in a non functioning dishwasher. This can be corrected by removing power from the unit this will reset the control.

Digital Display

The digital display is to indicate the current status of the cycle. The display is a two digit display so time will read from 1 to 99 minutes. If a cycle length is over 99 minutes, the display will have a plus sign (+) to the right of the numbers. This plus sign (+) will stay light until the cycle time drops below 99 minutes. The display may also have codes appear to indicate the status of the cycle or the condition of the dishwasher. The most common of these codes is an HO code which may appear and flash in the display, this indicates that the control has delayed the cycle to increase the water temperature. Another of these codes is a flashing CL indicates of an open door. This code can appear if the control is programmed and the Start/Cancel pad is pressed before the door is closed. Close the door and the cycle will start. The last of the common codes is a PF code. This will flash in the display on initial power up of the dishwasher or any time power to the dishwasher has been interrupted. There are fault codes that can appear in the display as well; these will be listed as failure codes in the control test section of this manual.

Status Indicators

The **WASHING** indicator is energized at the beginning of any wash cycle and will remain on as long as the vent actuator is not energized.

The **DRYING** indicator is energized when the vent actuator is energized and remains on until the end of the cycle regardless of which drying option is selected.

The **CLEAN** indicator is energized at the end of all wash cycles with the exception of a Rinse and hold cycle. The clean indicator will remain on until the door is opened. After the door is open, ALL indicators will be extinguished with the exception of the "Rinse aid low" if applicable.

The **SANITIZE** indicator is shown in the front display as an "S" and will be energized at the end of any cycle that the Santi option has been selected. The sanitize criteria must be completed correctly for this indicator to come on. This indicator will be extinguished when the door is opened.

The **Rinse Agent LOW** indicator on the keypad will be on any time the rinse aid level in the dispenser is low. This light will stay on until the dispenser is filled. The indicator can also be extinguished after 5 successive cycles have been run with out filling the dispenser. On select models an Lo will appear in the front display to indicate the rinse aid dispenser is low on agent.

Wash System

The wash system consists of wash pump and motor assembly to provide water under pressure for the three spray arms used to clean the dishes. These three spray arms will alternate operation starting with the lower spray arm. After a predetermined time the spray will change to the center and upper spray arms simultaneously.



Figure 4

Below the lower spray arm is the filter and soil director this covers the complete sump. The filter is intended to block loosened food particles from entering the wash sump area as they fall to the bottom from the spray action. See Figure 4

On the underside of the filter is a soil director which directs the loosened food particles to the lower left side of the sump to a stainless steel food macerator used to pulverize the soil so it can pass through the drain hose. See Figure 5

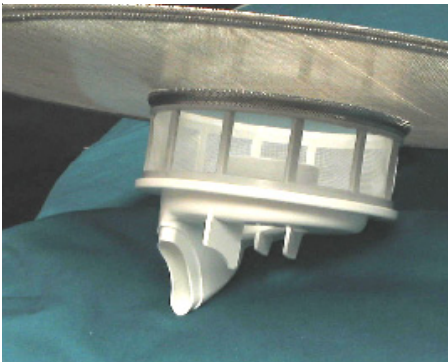

Figure 5

The remaining parts in the wash system are the sump assembly that acts as a reservoir for clean water being supplied to the wash pump and the delivery tube to supply water to the upper two spray arms.

The Alternating Wash System

This wash system is designed to spray from only one arm or one set of arms at a time. The advantage of this is that it reduces the amount of water needed in the tub. The way this system operates is explained as follows.

Alternating the spray is achieved with a check ball moving between two holes in the sump. One hole is located in the rear of the sump used to supply water to the upper two spray arms; the second is located out the top of the volute cover onto which is mounted the lower spray arm.

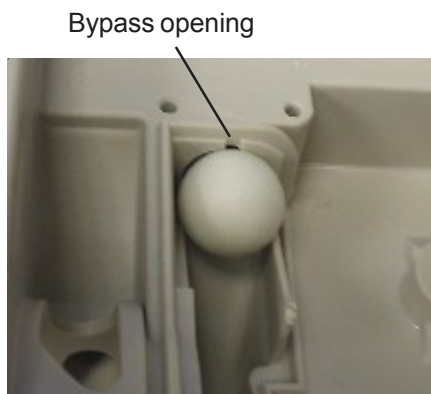

Ball covering back hole

Figure 6



Figure 7

The check ball rests at the end of a ramp molded into the sump partially blocking the rear hole. As water under pressure enters the volute cover, the check ball is held tightly into the rear hole restricting water flow from this opening. Water can only leave the remaining hole from the top of the volute cover into the lower spray arm. See Figure 7

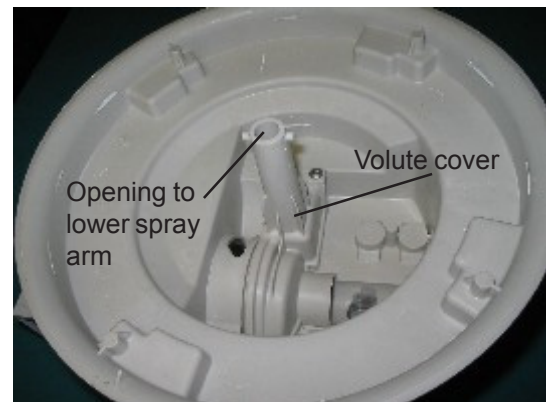

Figure 8

The force of the water entering and leaving the arm causes it to turn by the positioning of the hole in the spray arm. The rear hole which is molded in the sump has a small section removed above where the check ball sets, this section allows a small amount of water to by-pass the check ball and enter the delivery tube mounted up the outside rear of the tub. Water by-passing the check ball will fill the delivery tube at a rate of approximately four inches a second. This water will be used to change the spray from bottom to the upper two spray arms. All wash and rinse cycles will start by spraying from the lower wash arm. Changing spray from bottom to upper spray arms is accomplished with the control stopping the wash pump for not more than .6 of a second. This pause removes water pressure from the rear of the check ball, water that had accumulated in the delivery tube now reenter the sump, which moves the check ball away from the hole and up the ramp.

Ball at the top of ramp opening hole to center arm

The pump restarts the water pressure in back of the ball forces the check ball up into the top hole in the volute cover blocking water to the lower spray arm. Water exits the rear hole into the delivery tube supplying water to the upper spray arms.



Figure 9

Water in the delivery tube is divided with 80% going to the center spray arm and 20% to the upper arm. Water spray will continue from the upper spray arms, after a predetermined time the control will again pause the pump this time the pause will be for 3 seconds. This longer time allows for the delivery tube to completely drain then the check ball returns to the bottom of the ramp. The pump restarts with spray from the lower spray arm completing a spray arm change cycle.

Parts in the wash System

Wash Pump

These model dishwashers use a variable speed DC motor. The variable speed motor is used to improve cleaning by varying the water pressure depending on the cycle selected. An Ultimate Scrub and Maxx cycle intended for heavily soiled dishes will have a high pressure speed to better remove baked on food where a China/Crystal cycle, for very delicate items will have a very low water pressure setting. The user has an option to change the motor speed on some models. There is an added advantage of quieter operation when the lower speed is used. The motor and wash pump are supplied as a one piece assembly.



Figure 10

The speed of the motor is determined by the electronic control based on the cycle selected. The control continually monitors motor speed with input from a Hall Effect sensor mounted to the rear of the wash motor. Input voltage for operating the motor will be 120VAC with the motor changing this to VDC with a built-in rectifier.

Stainless Steel Filter

The stainless steel filter covers the entire sump area. The filter is intended to remove all food particles from the water so only clean water reenters the sump. There is a fine mesh polyester screen housing in the center of the stainless steel filter to house a lift out basket to catch larger items, this basket can be removed for cleaning. On the bottom of the inner screen housing there is a soil director used to direct food soil removed from the dishes to the left side of the sump to be removed first when the water is drained from the tub. The lower spray arm support is also used as a lock for the filter to insure it is down tight to the sump. See figure 11



Figure 11

Lower Spray Arm

This spray arm is designed using three spray arms to spray water up into the lower rack. There are also on the underside of this spray arms 4 legs used for cleaning the soil from the stainless steel filter. Three of the legs have spray openings pointed toward the center these will spray water across the top of the filter forcing the loosen soil to the center. The forth leg is mounted closer to the center of the spray arm, with a spray opening pointed straight down forces food collected in the center basket down into the soil director for removal in the drain segment of the wash cycles. Turning of the arm is accomplished by water under pressured sprayed from holes molded on top of the arm these force the arm to turn in a clockwise direction. The lower spray arm turns periodically in all cycles, this to keep the filter clean, and reduce chances of redeposit. See Figure 12



Figure 12

Center Spray arm

This spray arm is mounted on a short delivery tube to the under side of the upper rack. This arm rotates clockwise at approximately 20 rpm. The center spray arm and delivery tube will move in and out with the upper rack. There is a bellows mounted to the back end of this short delivery tube which forms a seal against the back wall of the tub when the spray arm is in operation. This delivery tube is also designed for the adjustable upper rack. See Figure 13



Figure 13

Upper Spray arm

This arm is located in the top of the tub and turns in a counter clockwise direction, and sprays simultaneously with the center spray arm. The mount for the upper spray arm serves as the lock nut for the delivery tube and is only available as an assembly. The spray arm will turn at approximately 40 rpm. See Figure 14



Figure14

Drain Pump

The only function of the drain pump is to remove water from the dishwasher. The drain pump is mounted directly to the front of the sump. The motor for this pump is rated a 1/25th hp drive motor. The drain pump only comes as an assembly. The front cover of the pump can be removed for cleaning if needed.

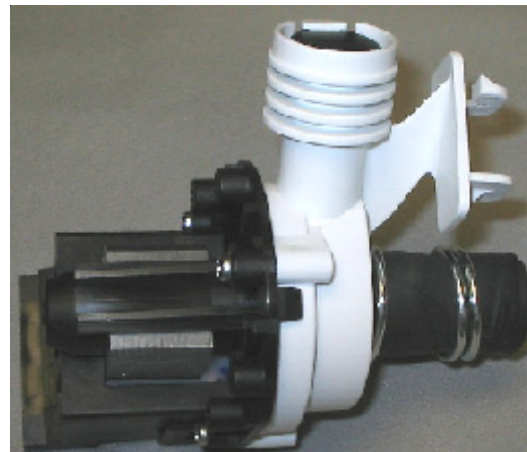

Figure15

With the drain pump mounted in this location it is accessible by removing both the outer door and the toe kick panels. The drain pump connector hose from the pump to the sump are supplied as an assembly. See Figure 15

Drying System

The Drying system consists of a Fan/Vent assembly, Heater, and Air Baffles. The way the systems performs is; as the dry portion of a wash cycle is reached the control activates the heater, if selected, and opens the vent door, located in the top right rear of tub, this allows the vent fan to draw in outside air resulting in hot air being forced out the bottom of the outer door panel. See Figure 16

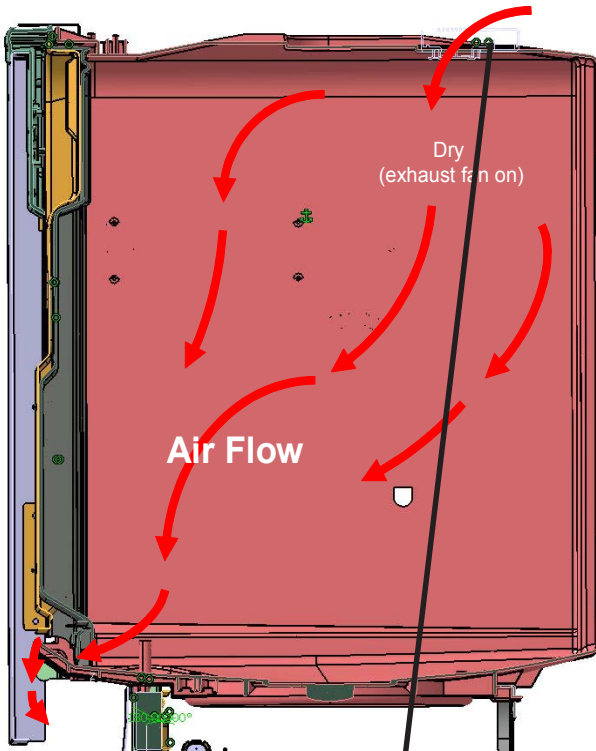

Figure 16

Fan/Vent assembly



Figure 17

Fan/Vent assembly located top right rear of tub. The vent door, normally closed, is opened by a 12 VDC solenoid also mounted in the assembly. There is an optical sensor to indicate to the dishwasher control that the vent door is properly closed until it is to be opened. See Figure 17 & 20

If for any reason this door is not closed, the control will attempt to close the door 5 times if it continues to fail a failure code will appear in the display. The dishwasher will not operate until this condition is corrected.

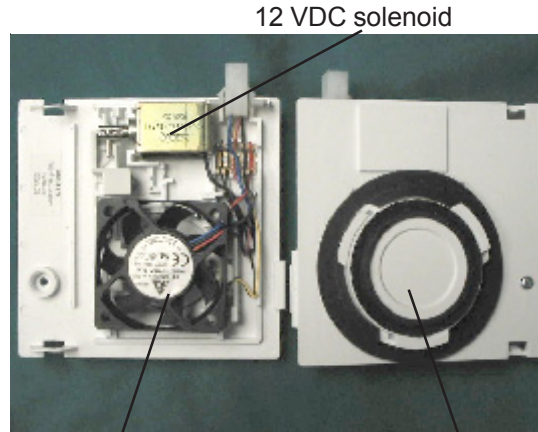

Figure 18

vent fan optical sensor vent door

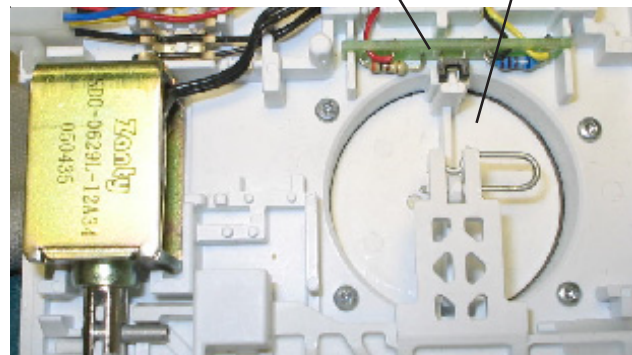
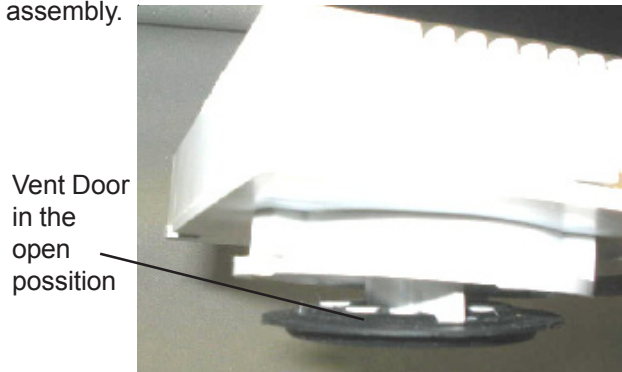

Figure 19

The vent fan starts as soon as the vent door is opened and turns at 3500rpm. The motor is powered by 12 VDC with a frequency generator to indicate to the control fan speed. If for any reason the Fan/Vent assembly would get disconnected, a failure code will appear in the display on the front of the door and the dishwasher will completely shut down. The dishwasher will not function without this assembly.



Vent Door in the open position

Figure 20

Heater

The heater mounted in the bottom of the tub increases water temperature, then in the dry cycle assist in drying the dishes. See Figure 21 The amperage draw of the heater can vary depending on the job it is to perform. When heating water, the amperage draw can be 900 watts. This amperage will drop to approximately 700 watts in the dry cycle. The design of the heater is to be more energy efficient. Mounted next to the heater on the under side of the tub is a safety thermostat. This thermostat will open if the temperature in the tub raises over 200°F. See Figure 22



Figure 21



Figure 22

Door baffles

Baffles have been installed into the bottom of the inner door panel to direct hot air out of the dishwasher. Foam baffle is mounted to the outside bottom of the inner door panel to keep steam and air from rising into the door. This foam baffle must not be removed. See Figure 23

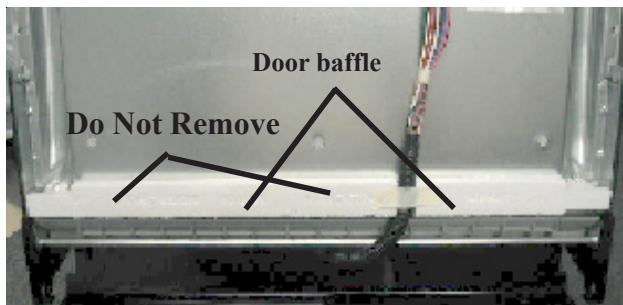

Figure 23

Dispensing System

The detergent and rinse aid dispenser consists of two dispensers combined in one housing and are controlled with one wax motor actuator. The first time the control energizes the actuator the cover over the detergent side of the dispenser opens dispensing detergent for the main wash cycle. The second time the actuator is energized rinse aid is released for the final rinse cycle. The detergent side of the dispenser consists of two cups: the smaller cup is for detergent used in the pre-wash cycle, the second larger cup is for the main wash section of the cycle. The rinse aid section contains a reservoir that will hold enough rinse aid for many applications. See figure 24 This reservoir has an indicator that will be clean if rinse aid needs to be added. A reed switch has been added to the rinse aid dispenser that informs the control when the rinse agent is low the control then displays and LO in the display to inform consumer of this condition. There is also an adjustable hub inside the dispenser, seen by removing the cap, to control the amount of agent dispensed. This detergent and rinse aid dispenser is replaced as a complete assembly. The cap for the rinse aid dispenser is the only part available for this dispenser.

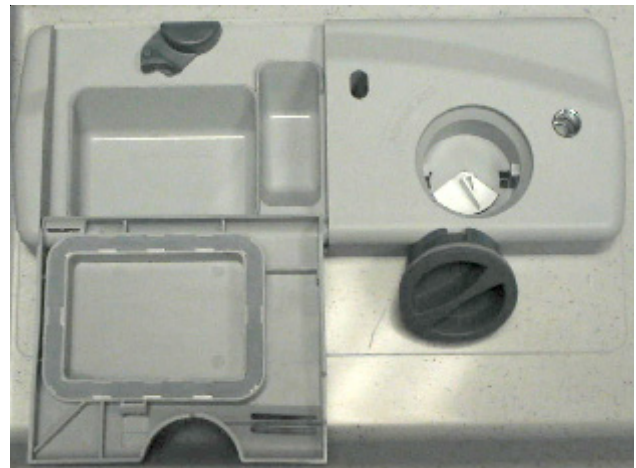

Figure 24

Dispenser Operation

The dispenser has two detergent cups both covered by the same cover. In the bottom center of the spring loaded cover is a thumb release. By pushing up on this release, the cover will open. The larger of the two cups, under the cover, is used for the main wash cycle the smaller for the pre-wash. With the detergent added the cover is closed. The cover is slotted so the detergent from the smaller pre-wash cup can be washed out without the cover opening.

After the fill in the main wash, the control applies power to the wax motor actuator. The plunger of the wax motor extends pressing down on a pivot arm attached to the latch for the cover, this releases the cover to dispense the detergent. On the opposite end of this pivot arm is a pin that rides up in the actuating arm for the rinse aid dispenser. Once power has been removed from the wax motor, the plunger retracts the pin riding in the rinse aid actuator follows a track down the back side of the actuator. The dispenser is now ready to dispense the rinse aid. The control again applies power to the wax motor the pivot arm raises the rinse aid actuator to release rinse aid into the dishwasher. When power is removed from the wax motor the pivot arm falls and a leaf spring mounted to the side on the dispenser forces the actuator arm to the starting position for the next cycle.

Door latch assembly

The door latch assembly performs two functions: first to close and latch the door to the tub, second is to actuate both of the door safety switches to insure the door is closed before the dishwasher can be operated. The latch mechanism is mounted to the inside door panel with a lock tab at the bottom of the latch body and two location pins on the back then secured with two screws. As the door is closed the strike mounted to the top of the tub presses in on the locking cam and rotates it forward this raises a lock into the center opening of the strike. As the cam in the latch is pressed forward it releases the door switch actuator closing both switches. See Figure 25 The handle mounted to the outer door panel is used to open and close the door

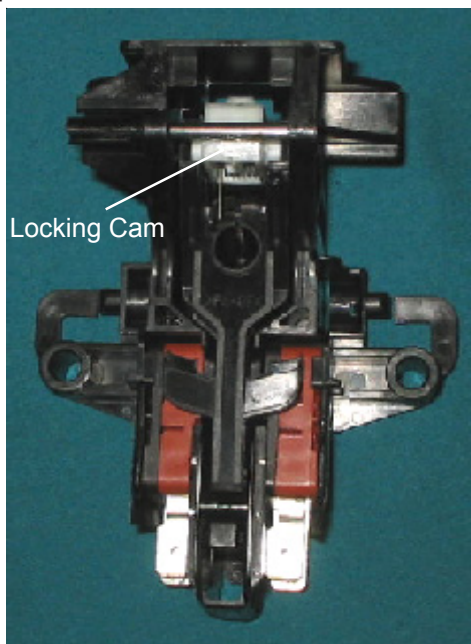

Figure 25

Fill system

The fill system of this dishwasher consists of the water fill valve and a float safety switch. Power from the control is applied to the water fill valve through the float safety. The water valve is an electrically operated shut off valve with a flow washer that regulates the amount of water based on the water pressure applied to the valve inlet. Water pressure needs to be between 20 and 120 psi for the dishwasher to have the proper amount of water for operation. See Figure 26

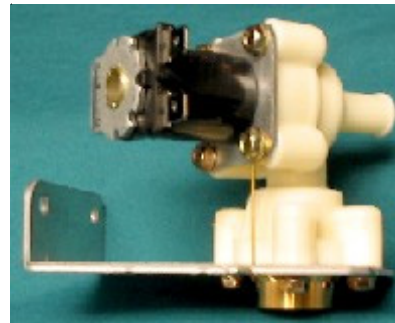

Figure 26

The float safety switch will shut off power to the valve if the tub over fills with water. Water enters the tub through an air gap mounted to the left side of the tub. See Figure 27



Figure 27

Door Hinge and Spring

The inner door panel is attached to the tub frame by hinges. On the face of both hinges there are fiber pads that act as breaks to hold the door at any angle, these pads do not interfere with the smooth up and down movement of the door. There are door springs and cables on both hinges to assist in opening and closing the door. The door spring, which is attached to the rear frame, has a cable that passes around a friction bearing before attaching to the door hinge. This spring and cable assembly provides a quieter, smoother, operating door. See Figure 28

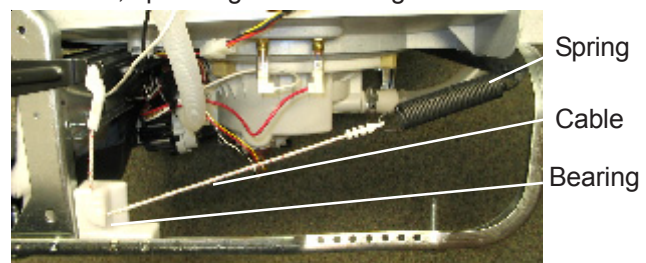

Figure 28

The Control System

The electronic control, with input from various sensors, has total operation of the dishwasher once a wash cycle has been started. The electronic control is mounted inside the console with its power coming directly from the power junction box. Power to operate the control can not be interrupted by opening or closing the door. However, the control does know when the door is opened. The black power lead from the door switch is attached to the control this line operates all of the components in the dishwasher. Input to the control comes from the following: the **keypad** is a membrane switch that allows the user to select a specific wash cycle and any available option for the dishwasher to perform, a **soil sensor** that determines the concentration of soil in the water, a **thermistor** to measure the temperature of the water, a **Hall sensor** to track the speed of the motor, an **optical sensor** reports the position of the vent door, finally a **reed switch** in the rinse aid dispenser to report the presences of rinse aid in the dispenser. This section will describe the sensors how they operate followed by tests that can be performed to test the control system and all of the components in the dishwasher.

Soil Sensing

A soil sensor is used by the control to make adjustments to length of wash cycles based on the soil level found in the water. This sensor is located in the base of the sump directly in front of the wash motor intake. The soil sensor receives a voltage signal from the control which it converts into a small beam of light; the transmitter then directs this light beam to a receiver through water that has been used to pre-wash the load in the unit. As the light passes through the water the density of the water can reduce the strength of the light beam reaching the receiver. The receiver turns the light back to a voltage this is then returned to the control, which interprets this reading and adjusts the cycle length accordingly. See Figure 29

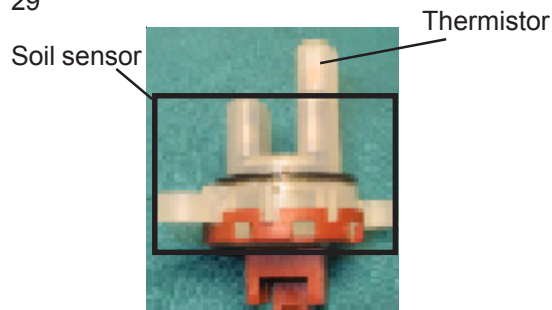

Figure 29

The number of times the control checks the soil level varies with cycle but in cycles it is used the pre-wash water will always be checked. The control can increase a cycle length or decrease as needed but never longer than the longest cycle or shorter than the shortest cycle available.

The control pauses the wash motor for 30 seconds to allow time for the water to settle before checking then the water is drained and any adjusts to the cycle are made.

Temperature controls

The control is programmed with preset wash and rinse temperatures for each cycle. The use of a thermistor in the sump provides water temperature information to the control to maintain these temperatures. The control provides options for the user to select a higher temperature wash as well as a sanitize rinse.

The thermistor is located in the same housing as the Soil Sensor. The post on the Soil Sensor that is taller is the location of the Thermistor. With the sensor in the water of the sump it gets a more accurate reading of water temperature. See Figure 29

To insure the pre-programmed water temperature for the wash cycle is reached the control can pause the main wash cycle up to 10 minutes in a Temp assure cycle. This Temp assure cycle is automatic and not selected as an option. If the Hi-temp wash option is selected, the control will delay the main wash section once again for up to 10 minutes to increase the water temperature to a higher degree. Whether or not the water temperature is reached in this 10 minutes delay, the cycle will continue without indication that it reached or did not reach this temperature.

When the Sanitize option is chosen, the National Sanitation Foundation requires in the final rinse cycle that 155°F be reached and maintained for a certain amount of time. During the final rinse, the control pauses the time remaining for up to 30 minutes to reach this 155°F temperature before proceeding to the end of the cycle. Should the cycle meet the requirements defined for the sanitize option, the Sanitize light will come on and stay on until the door is opened. If the requirements are not met the sanitize light will not come on at the end of the cycle.

Service Tests

The control has a number of tests that have been programmed into its memory most of these are for manufacturing purposes and are not useful for field service. At times, if certain pad combinations are pressed, different codes may appear in the display that are unknown or not listed, what needs to be done is disconnect power to the unit then reconnect. You can then continue with servicing the dishwasher.

The control has service tests programmed into it that can be of assistance to the service technician in diagnosing control and component problems with this unit. These tests are; The Water /Service Test, Water Temperature Test Mode, and The Relay/Triac and Sensor Test.

To insure the correct pad is pressed to enter and use these tests the pad locations will be numbered 1 through 11 with pad # 1 being the pad furthest to the left and pad # 11 the furthest to the right. In all cases the pad to the right will always be the Start/Cancel pad.

Water Temperature Test

This test will allow the service technician to check the temperature of the water in the sump of the dishwasher while at idle or while it is in operation. The temperature of the water will show in the display using the last two numbers in the degrees. On temperature over two numbers the display will read the last two numbers in the temperature and a plus (+) sign, an example of this is the water in the sump is 120° will read 20+ in the display.

To active the Water temperature test

With the dishwasher in idle press and hold the Normal wash and the Start/Cancel pads simultaneously for 3 seconds the temperature will be shown in the display. To terminate this test press and hold the Normal wash and the Start/Cancel pads again for 3 seconds.

With the dishwasher in operation, press the cycle selection pad of the cycle that is in operation and hold in for 3 seconds the temperature will be displayed. The temperature will stay in the display and update every 3 seconds. To terminate this test press and hold the same cycle selection pad used to start the test.

Water/Service Test

In the Water/Service Test, the control will step through each function of the product and operate each component before ending and illuminating the CLEAN and SANITIZE LED's. Along with checking the operating components the control will check all of the input sensors as the test progresses, if at any time a failure in one of these sensors is detected, the test will stop and a failure code will be displayed.

To Start the Test

From an idle condition, this is with no programs entered into the control, press pad # 10 and the START/CANCEL simultaneously for three seconds. You will know that the test has started by the water valve being activated and the Washing and Sensing LED lighting. The test will automatically advance through the complete test unless the control detects a failure in one of the sensors. The test may be manually advanced by pressing the START/CANCEL pad. Each time the pad is pressed the cycle is advanced one segment.

To Exit the Water serviceTest

At the end of the test the control lights the CLEAN and SANITIZE LED's. With these indicators light, opening then closing the door will give a PF code in the display, the START/CANCEL pad can now be pressed to clear the test and restart the dishwasher.

Chart For the Water Service Test

DESCRIPTION	Total time, (sec)	Water valve	Circulation motor	Drain Motor	Heater	Dispenser	Fan unit	Washing LED	Rinsing LED	Drying LED	Sanitize LED	Sening LED	Clean LED	Device being monitored	Display Flashes when detection of failure
FILL/DISPENSER	60	1	0	0	0	1	0	1	0	0	0	1	0	fan damper	uo
FILL	27	1	0	0	0	0	0	1	0	0	0	1	0	turbidity	tu
WASH/HEAT (3450rpm)	45	0	1	0	1	0	0	1	0	0	0	1	0	hall sensor	hs
PAUSE	0.4	0	0	0	1	0	0	1	0	0	0	1	0		
WASH/HEAT (2800rpm)	75	0	1	0	1	0	0	0	1	0	0	0	0		
WASH/HEAT/DISP (3450rpm)	60	0	1	0	1	1	0	0	1	0	0	0	0	thermistor	th
DRAIN	90	0	0	1	0	0	1	0	1	0	0	0	0	fan speed	uF
DRY	90	0	0	1	X	0	1	0	0	1	0	0	0	rinse aid	rA
TOTAL	447							0	0	0	1	0	1		

X- denotes a selectable option

SANITIZE and CLEAN LED stay on until door is opened or cycle started.

If the rinse agent is low in the dispenser LO will be displayed in the front display.

Relay/ Triac and Sensor Test

This test allows the servicer to troubleshoot the dishwasher by energizing the different devices of the dishwasher independently from one another. The best way to understand the value of this test for field service technicians is the example of testing the heater for operation. Enter the test followed by pressing pad number 10 on the keypad (see table) this will apply power to the heater. The heater will be powered until the same pad is pressed a second time.

This test can only be entered from a PF (Power Failure) condition. This can be accomplished in two ways. First is to have the power removed from the dishwasher then turned back on this will show a PF in the display and the test can be entered.

The second method to enter this test is to program the control into a Water/Test, at the completion of this test then open the door the control goes into a PF condition now program the Relay/Triac test. By going through the water test you do not have to disconnect power to the unit and the test can be entered rather quickly.

To access this test the unit must be placed in PF condition. While in PF press and hold Pad # 1 and Pad # 7 at which time an "rt" will appear in the display. You can now follow the chart below as to how to select the component to operate. While in this test if you wish to test more then one component you must always repress the previously selected pad to leave one component before moving on two the next. When the tests are completed you must again Press Pad # 1 and the Pad # 7 this will return you to PF mode.

Relay/Triac and Sensor Test

To access this test the unit must be placed in PF condition. While in PF press and hold Pad # 1 and Pad # 7 at which time an "rt" will appear in the display. You can now follow the chart below as to how to select the component to operate. When the test is complete you must again Press Pad # 1 and the Pad # 7 this will return you to PF mode.



FUNCTION	PAD TO BE PRESSED	FUCTION PERFORMED	LED ILLUMINATED	IN DISPLAY
Start Test	Ultimate Scrub or Maxx Clean & Rinse Only			"rt"
Active water valve	Pad # 1	watervlve on/off	Ultimate Scrub or Maxx Clean	valve on =FL Valve off = rt
Test Variable Speed motor Function #1	Pad # 2 (1 Time)	wash motor @ 2800 rpms	Speed Wash pad	First two digits of motor speed
Test Variable Speed motor Function #2	Pad # 2 (2 Times)	wash motor @ 2950 rpms	Speed Wash pad	First two digits of motor speed
Test Variable Speed motor Function #3	Pad # 2 (3 Times)	wash motor @ 3100 rpms	Speed Wash pad	First two digits of motor speed
Test Variable Speed motor Function #4	Pad # 2 (4 Times)	wash motor @3450 rpms	Speed Wash pad	First two digits of motor speed
Stop Variable Speed Test	Pad # 2 (5 Times)	Wash motor off	None	"rt"
Heater on/off	Pad # 10	Heater on/off	No Heat Dry	on = HO off = "rt"
Detergent Dispenser	Pad # 3	dispenser powered	Normal Wash	on = Sd off = "rt"
Rinse aid level	Pad # 7	none	Rinse only	low = RE full = RF off = "rt"
Drain pump	Pad # 4	drain pump on/off	China Crystal or Party glasses	on = dP off = "rt"
Vent/ Fan dry	Pad # 5	Active vent on/off	Top Rack, Eco Wash Glasses	on = Fan speed off = "rt"
Soil Sensor	Pad # 8	none	Wash Silencer or Wash pressure	on = senser voltage reading off = "rt"
Thermistor	{Pad # 9	none	Wash Temperature	on = Temperature in °F off = "rt"

Control Codes

At time codes may appear in the display below are a list of codes. Not all codes are failure or error codes so be sure to read what the code means.

Display	Reason for Code	What it indicates
"uo"	Vent open	When is a wash cycle the control does not receive the proper indication that the vent is closed. The control will try to reseal the vent if after 5 attempts the vent does not close the failure will appear. The cycle will not start.
"uF"	Fan is not running	When in the dry mode, the control does not receive the proper feedback from the vent that the fan is running at the proper speed. The failure will appear and the control shuts down
"Er"	Membrane Switch failure	When the control verifies that any of the pads on the membrane switch has been closed for one minute the failure will appear in the display
"CE"	Configuration error	On power up the control verifies a problem with the options the failure will appear.
CL	Door switch open	The control is not receiving power from the door switch
dP	Drain pump operations	This will be seen in the r/t test if pad # 4 has been pressed
FL	Water valve is on	This will be seen in the r/t test if pad # 1 has been pressed
HO	Heat delay	The control has extend the length of a cycle to allow for in increase in water temperature
hs	Hall Sensor	The control has sensed a problem with the Hall style sensor in the wash motor.
LO	Low rinse aid	The control has received a signal form the rinse aid dispenser that the rinse agent level is low.
PF	Power failure	The control has experienced drop in power to the processor
rA	Rinse aid	The control has sensed a problem with the reed switch in the Rinse aid dispenser
RE	Rinse aid	The reed switch in the rinse aid dispenser is closed. This can be seen in the r/t test if pad # 7 has been pressed
RF	Rinse aid	The reed switch in the rinse aid dispenser is open. This can be seen in the r/t test if pad # 7 has been pressed
rt	Relay/triac test	The control has entered the r/t test program
Sd	Detergent disp.	The detergent dispenser has been activated
tu	Turbidity sensor	The control has sensed a failure in the turbidity sensor while in the Water Service test.
UL	UL test mode	The control has been programmed for a UL test mode.

DISASSEMBLY AND SERVICE

SAFETY PRECAUTIONS

Always turn off electrical power supply before servicing any electrical component, making ohmmeter checks, or making a part replacement. Refer to safe service procedures at the front of this service manual before servicing the dishwasher.

All voltage checks should be made with a voltmeter having a full scale of 130volts or higher.

After service is completed, be sure all safety grounding circuits are complete, all electrical connections are secure, and all access panels are in place.

CONTROL PANEL

Note:

Console will come as console assembly consisting of the following; console, keypad (installed), and foam blocks around ribbon.

1. Disconnect the dishwasher from electrical supply.
2. Remove the outer door panel;
 - a. The outer door panel is held to the inner door panel by two screws and four locking tabs, two on each side of the door panel.
 - b. Remove the lower two screws, one on each side that secures the outer door to the inner panel.
 - c. Close the door and slide the door panel down and outward to remove.
6. Remove the six remaining screws mounting the control panel to the inner door.

Electronic Control

1. Disconnect the dishwasher from electrical supply.
2. Remove outer door panel
3. Remove console from top of inner door panel
4. Remove control cover (3) mounting screws.
5. Remove wires and plugs connectors See Figure 30
6. Raise ribbon lock and remove ribbon from control See Figure 30
7. Remove control
8. On installation make sure all wires are connected in proper location and tight to terminal.

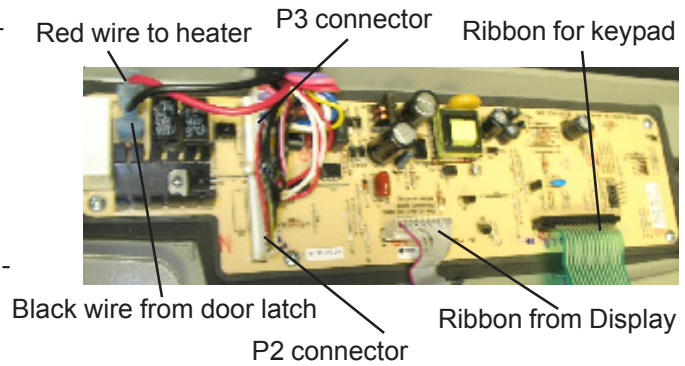

Display

1. Disconnect the dishwasher from electrical supply.
2. Remove outer door panel
3. Remove console from top of inner door panel
4. Remove control cover (3) mounting screws
5. Disconnect plug from control to display
6. Press in on plastic retainer holding display in to console, push display out from rear. See Figure 31
7. Reassemble in reverse order.

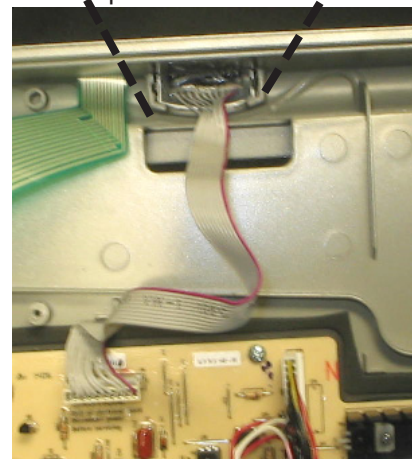
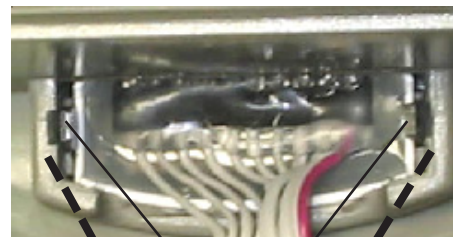

Figure 31

Door Latch

1. Disconnect the dishwasher from electrical supply
2. Remove outer door panel
3. Remove console
4. Remove wires from both door switches
5. Remove two Torx screw holding latch See Figure 33
6. Pull latch out at the top from inner door panel and up to clear location tab on rear of latch. See Figure 32
7. On installing wires on door switches make sure both white wires are on one switch and both black wires are on the opposite switch.
8. Install latch in reverse order.

Location pins



Figure 32

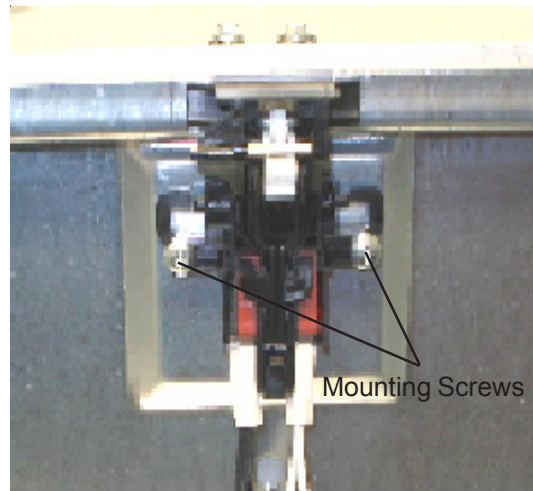

Figure 33

Door Strike

The door strike mounts to the top frame of tub with two 5/16 bolts the strike is not adjustable. The strike is the part the door latch attaches to when closed. To replace the tub will have to be pulled forward to access the two mounting bolts. See Figure 34

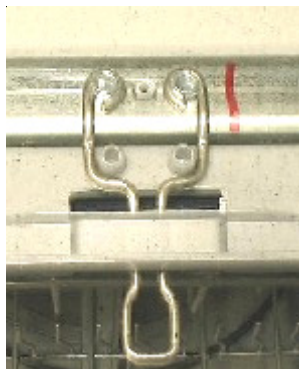

Figure 34

Detergent/ Rinse aid Dispenser

To diagnose operation of the dispenser use the Water Service Test

See the section on testing the control system.

1. Disconnect the dishwasher from electrical supply
2. Remove outer door panel
3. Disconnect wiring from dispenser
4. Remove six Phillips screws and carefully push dispenser into the tub

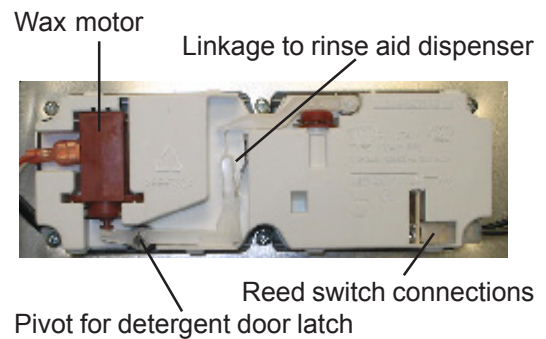

Figure 35

Door hinge

1. Disconnect the dishwasher from electrical supply
2. Remove outer door panel
3. Dishwasher needs to be pulled forward to replace door hinge
4. Check water line and drain hose before removing counter top screws and pull forward.
5. Remove cable and spring from hinge.
6. Remove bolts mounting hinge to inner door panel. Take care not to damage foam baffle at bottom of inner door panel.
7. Remove hinge pin hold hinge support with pliers while removing pin.
8. Install hinge make sure the shoulder on hinge pin is properly in hole in hinge before tighten pin.
9. Complete repair in reverse order.

Door Seal

1. Door seal just pulls out of channel around tub.
2. To replace find center of gasket make sure back goes into channel first. Back is marked with a color stripe.



Figure 36

3. Starting at center top press gasket into channel just to hold in place See Figure 36

4. Go to bottom on either side find block molded into bottom of tub fill block with gasket.

5. Form gasket into an "L" press gasket up channel in several spots. See Figures 37&38



Figure 37



Figure 38

6. Repeat steps 4 and 5 for opposite side
7. Close door to seat seal.

Bottom Door Seal



Figure 39

Bottom

1. Remove lower rack from tub
2. Open door completely down door seal can be pulled out from the right side. See Figure 39 & 40
3. Pull straight into tub.
4. When installing new seal place seal in channel just enough to hold in place
5. Close door for tub to push seal in place.



Figure 40

Upper Rack

1. To remove rack, unsnap and remove retainers at end of metal track. Once retainers are removed, pull rack straight out.

Tub Roller Assembly

There are two tub roller assembly, front and rear, on both sides of the tub. Each assembly has a top and a bottom rollers installed on a mounting plate with molded in axles, these assemblies are screwed into the tub using two screws. See Figure 41.

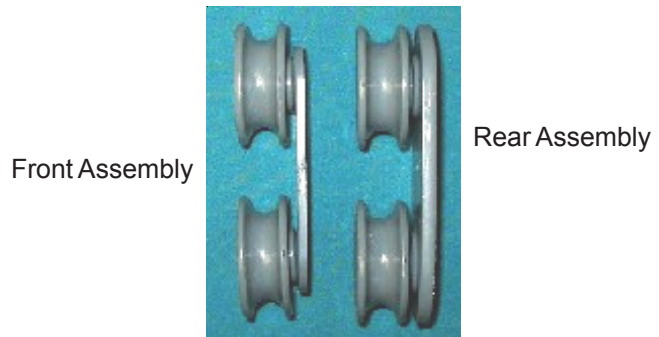

Figure 41

CENTER SPRAY ARM

1. Pull upper rack forward to gain access to spray arm.
2. Center spray arm and delivery tube are an assembly, push this assembly to the rear to loosen and remove from rack. See Figure 42

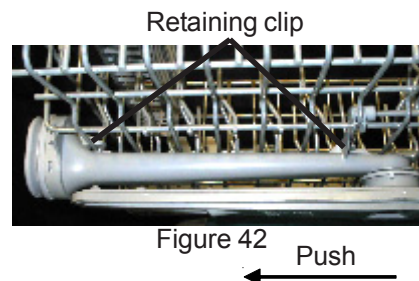

Figure 42

Push

Upper Spray Arm

To remove the upper spray arm turn the mounting nut counter clockwise to unscrew from delivery tube. If mounting nut is too tight place the handle end of pliers into the notches and turn to remove.

Lower Spray Arm, Spray Arm Support & Filter See Figure 43

1. Remove lower rack
2. Lower spray arm clips onto the lower spray arm support lift spray arm off support

Spray arm support & Filter

1. Turn support clockwise 90° lift support from sump.
2. Filter is now free to lift out

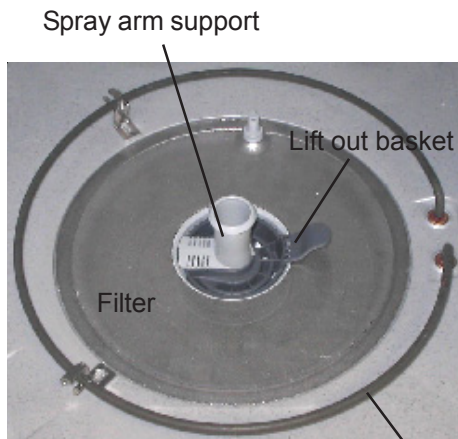

Figure 43 Heater

HEATING ELEMENT

1. Disconnect the dishwasher from electrical supply
2. To remove element disconnect wiring and remove two element mounting nuts. See Figure 45
3. Lift terminal ends from tub.
4. Raise locking hook on mounting brackets to slide element from brackets. See Figure 44

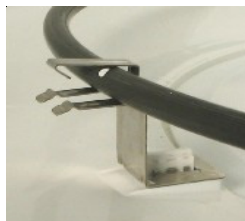

Figure 44



Figure 45

FLOAT SWITCH AND MOUNT BRACKET

Remove float by lifting up out of tube molded in bottom of tub.

1. Disconnect the dishwasher from electrical supply
2. For ease of service, remove outer door panel and the kick plate, remove wires to float switch.
3. Unscrew Phillips screw holding assembly to tub, there is a hole provided in the actuator lever to access screw. Screw will remain in assembly once removed.
4. When installing Switch and bracket onto tub make sure mount stays tight to tub. See Figure 46



Figure 46

WATER VALVE

Testing water valve and float switch is best preformed by using the Water Service Test see section on testing the control system to start this test.

1. Disconnect the dishwasher from electrical supply
2. Turn water off to dishwasher before replacing valve
3. Gain access to valve remove wiring, water line, and fitting from valve.
4. Water valve is secured with two screws. See Figure 47

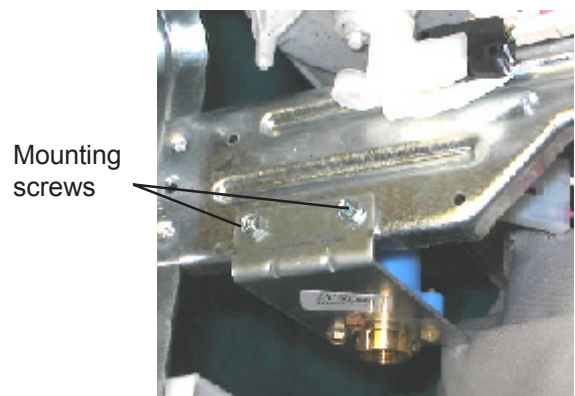

Figure 47

DRAIN PUMP

Testing the drain pump can be done by using the Water Service Test following the test the drain pump will be activated when the number 7 appears on the display then check for power the drain pump. To start the Water Service Test see the Section on checking the Control System.

Replacing the Drain Pump

1. Disconnect the dishwasher from electrical supply
2. Gain access to drain pump remove wiring and drain hose from pump. Slide clamp on sump end of the hose between pump and sump to the center of hose

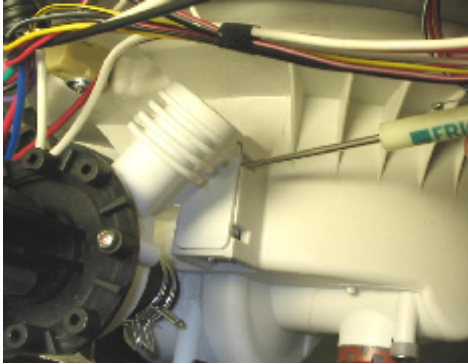

Figure 48

Slide this clamp toward the drain pump

3. Insert small screwdriver into top hole of pump mount on front of sump, push down on screwdriver to release top mounting hook pull top of pump back and hold. To help hold this out use something small as a wedge between the pump mount and the sump this will keep this out while you move to the bottom lock. See Figure 48

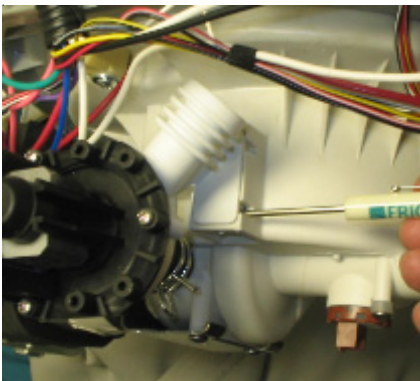

Figure 49

4. Insert screwdriver this time in lower hole of the pump mount, push down and pull back on pump will release pump from sump. See Figure 49
5. Pump can now be removed.

PUMP AND MOTOR ASSEMBLY

1. Disconnect the dishwasher from electrical supply
2. Remove spray arm, spray arm support, and filters from inside of tub
3. Remove outer door panel and kick plate to gain access to the under side of the dishwasher.
4. Disconnect wires from both wash motor and drain pump, then loosen the clamp on the delivery tube, the clamp can be reached on the right side, between the sump and the side frame of the unit. The delivery tube clamp has a 5/16 inch head. Carefully push delivery tube away from the rear port of the sump. See Figure 50

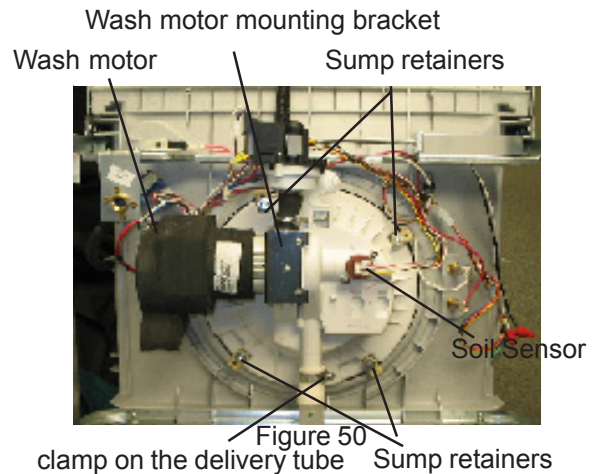

Figure 50

5. Pump and motor assembly is secured in place using four retainers that will turn into sump to release from tub. Push sump into tub, then by rotating to the right will aid in clearing wash pump and drain pump as sump is lifted out.

Remove motor from sump.

1. Remove sump from tub
2. Remove volute cover and check ball
3. Turn sump over and remove motor mounting bracket (2 screws)
4. Lift bracket from sump.
5. Return sump to up right position.
6. Place end of a flat blade screwdriver in front of wash impeller and force motor out rear of sump. See Figure 51

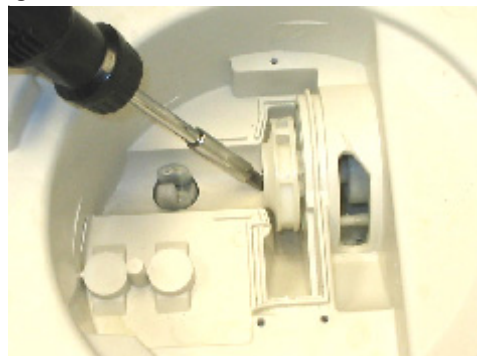

Figure 51

The following repairs will require removing the dishwasher from under the counter. Before starting the repair, disconnect the power to the product, also make sure others are aware that you have turned this off for your safety. Turn off the water supply to the dishwasher and mark the valve as being turned off this is again for safety. After the utilities have been turned off, lower the dishwasher as much as possible to prevent damage to the counter. Always use floor protection as the unit is pulled forward.

DELIVERY TUBE

1. With dishwasher removed from under counter top unscrew and remove the upper spray arm. This unscrews counter clockwise.

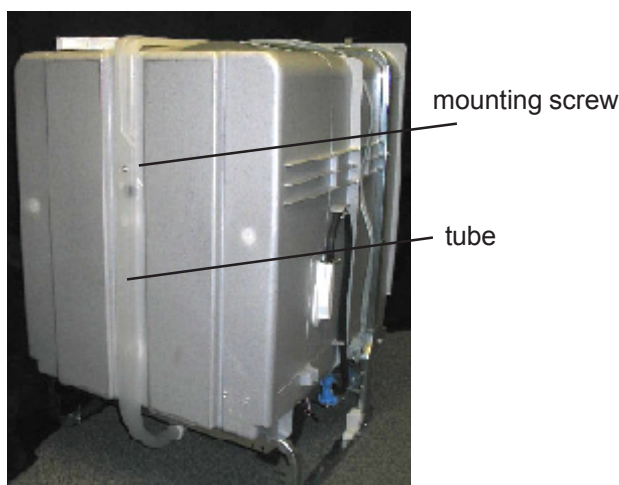

Figure 52

2. Remove mounting screw in back of tub. See Figure 52
3. Remove clamp from sump end of tub and remove tube.



Figure 53

4. Check hole in back of tub for grommet to be sure it is smooth and no extra plastic around opening
5. Install grommet from inside tub, outside flange must be flat on back of tub. See Figure 53

outside flange

6. To install tube start by placing tube in top of tub and installing upper spray arm loosely.
7. Place center opening of delivery tub into the tub. Be sure to hold grommet in place while pressing tube into opening.

8. Reinstall tube on to sump then install center screw.
9. Tighten both upper spray arm mounting nut and clamp on sump.

Vent and Fan Assembly

1. With the dishwasher removed from under the counter either remove the upper rack or just pull forward to access the vent assembly
Vent and fan assembly mounting nut.



Figure 54

2. The locking collar holding the assembly in place turns off to the left (counterclockwise). See Figure 54

This is a very tight fit pressing down on the outside of the assembly can help in removing part See Figure 55



Figure 55

3. Installing new assembly be sure gasket is in place and collar locks on completely to prevent leaks. See Figure 56

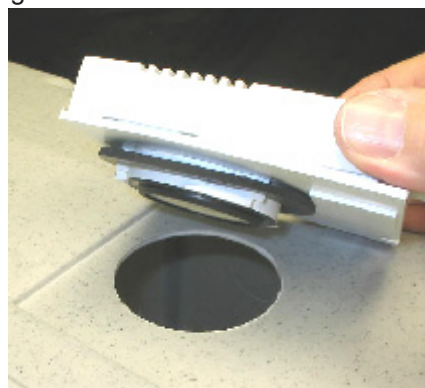
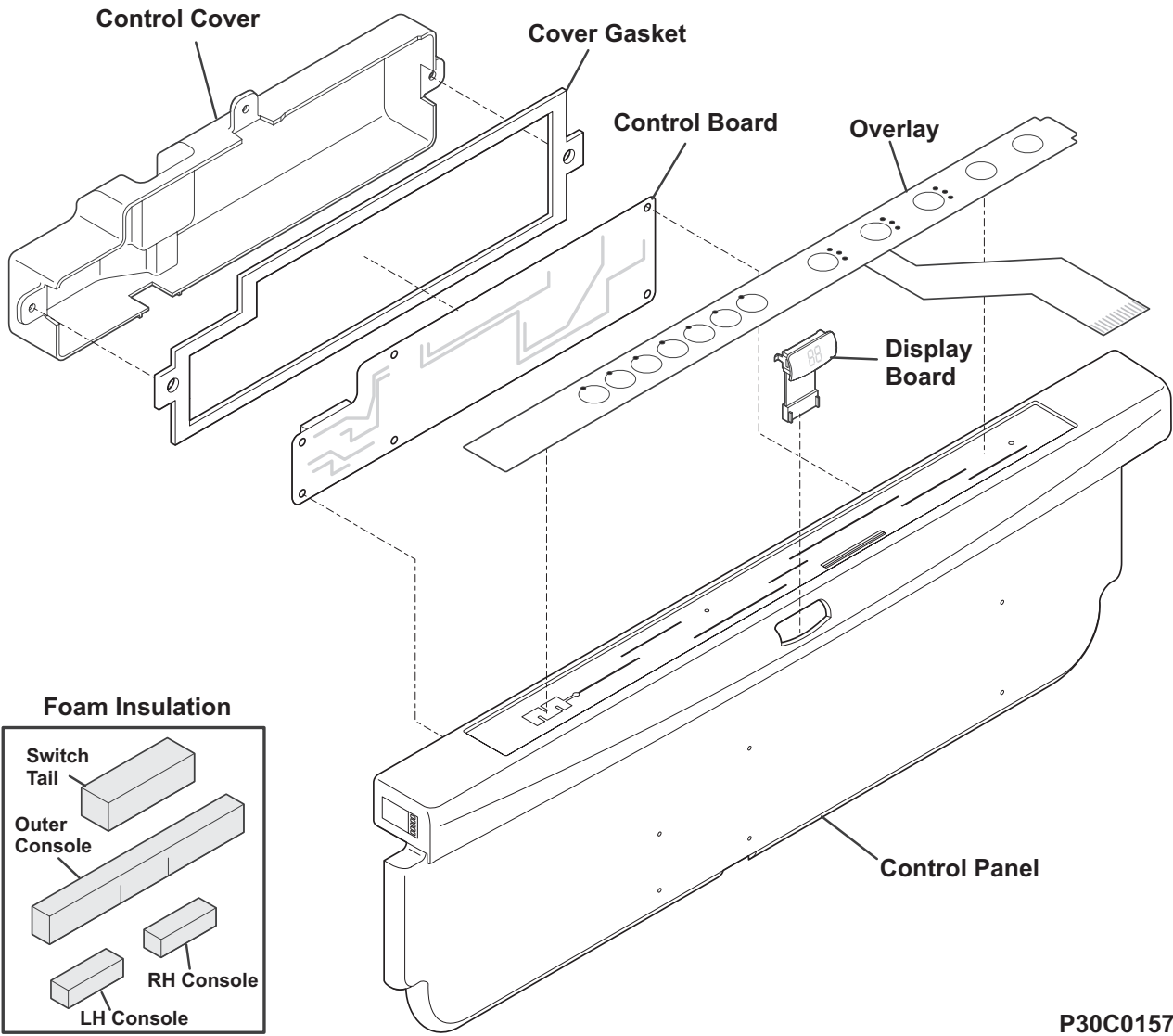

Figure 56

CONTROL PANEL

Models
LEDB500FEE0
PLD4375RFC0
PLD4555RFC0



P30C0157

DOOR

Model LEDB500FEE0

Detergent/Rinse Aid Dispenser

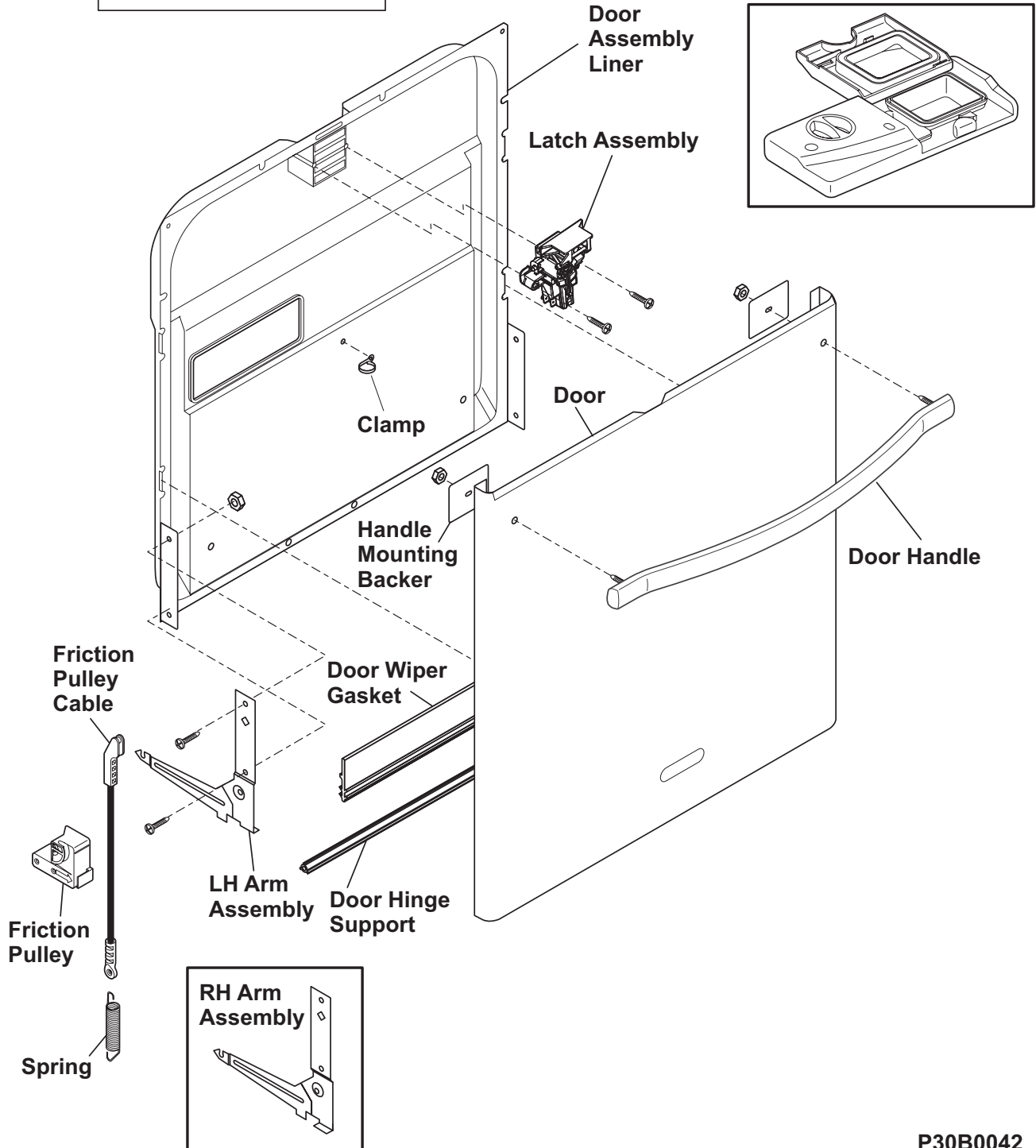

P30B0042

DOOR

Models
PLD4375RFC0
PLD4555RFC0

**Detergent/Rinse Aid
Dispenser**

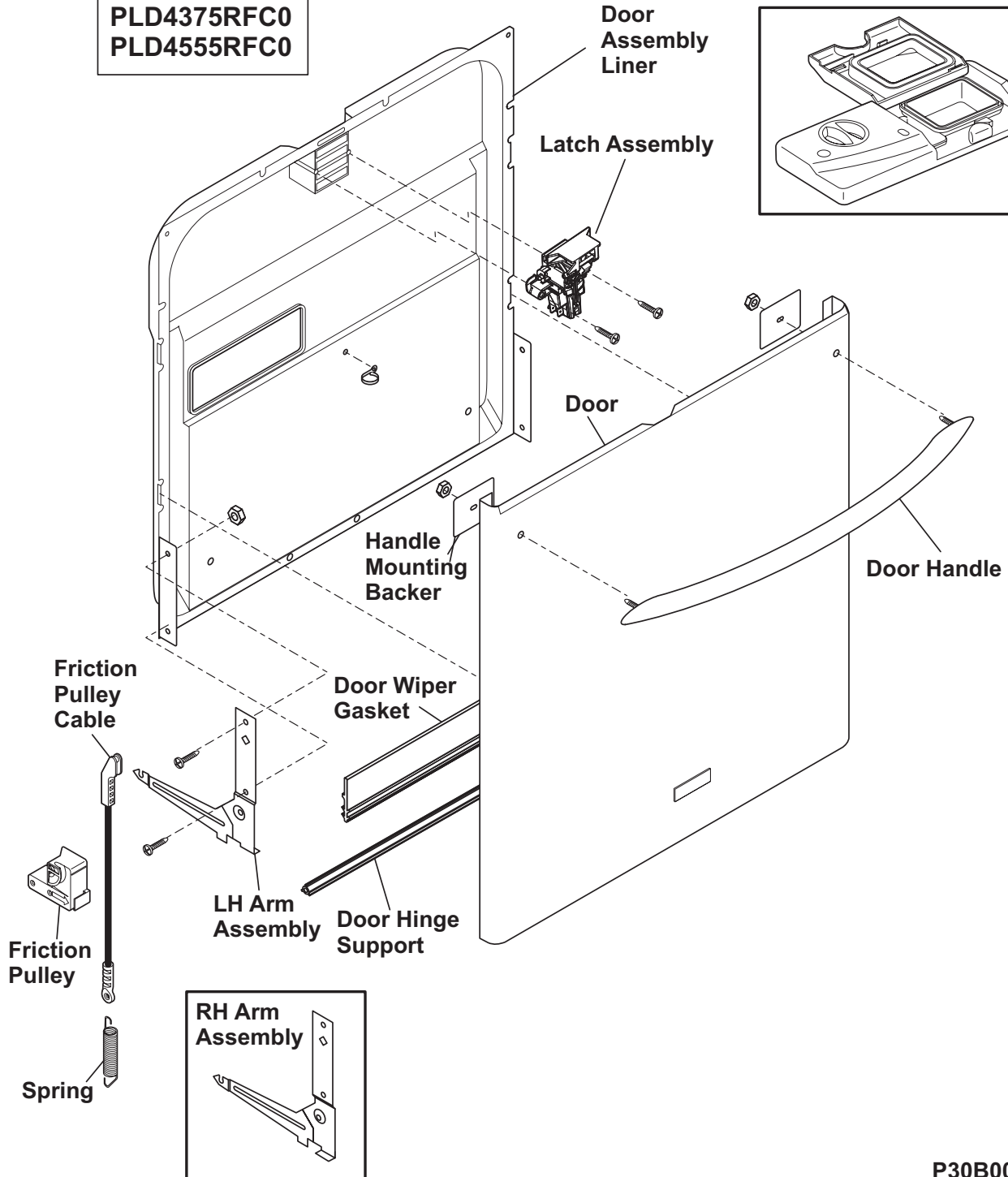
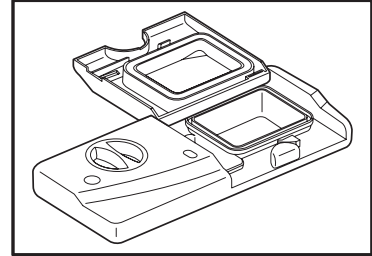

P30B0044

TUB

Models
LEDB500FEE0
PLD4375RFC0
PLD4555RFC0

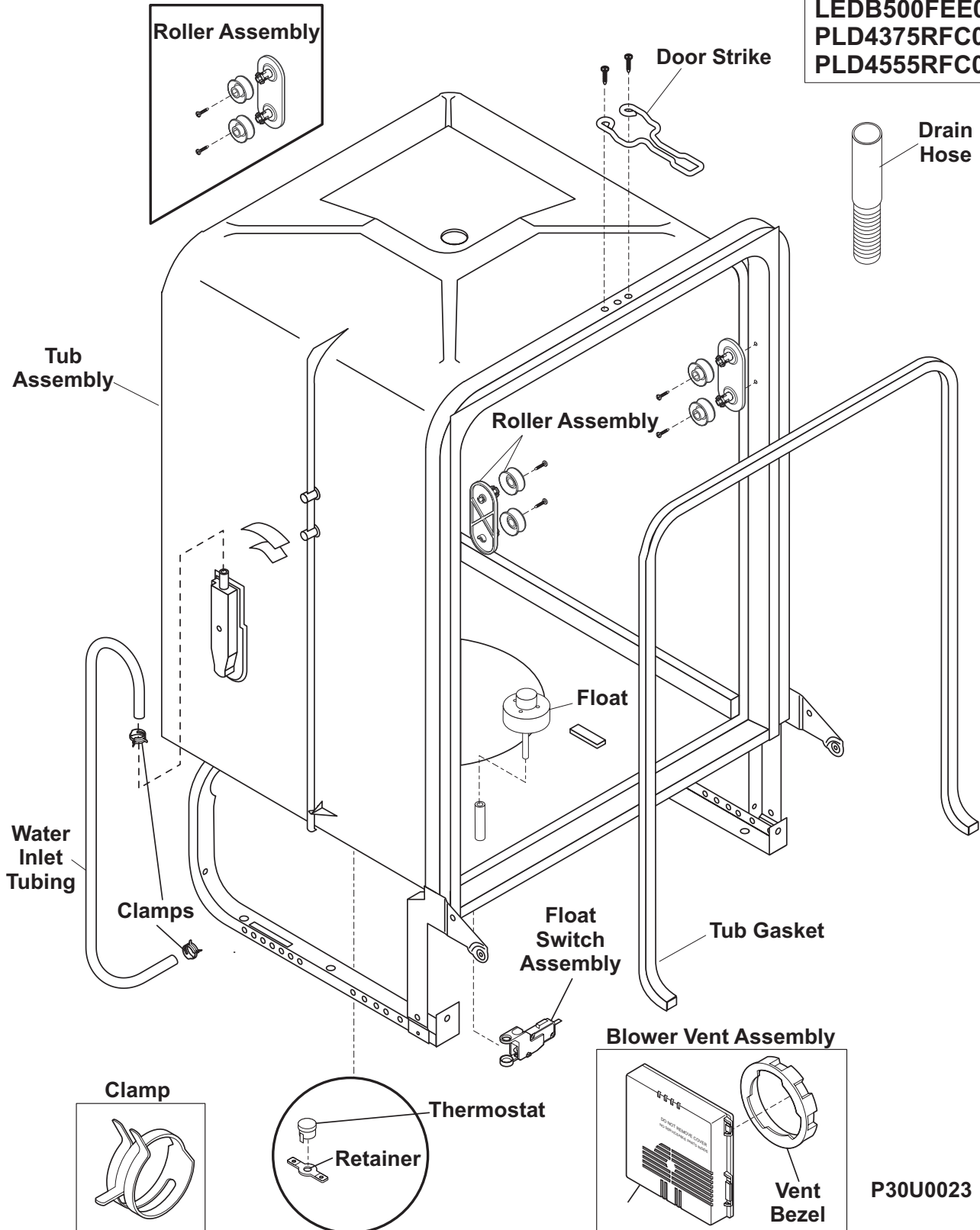

P30U0023

MOTOR & PUMP

Models
 LEDB500FEE0
 PLD4375RFC0
 PLD4555RFC0

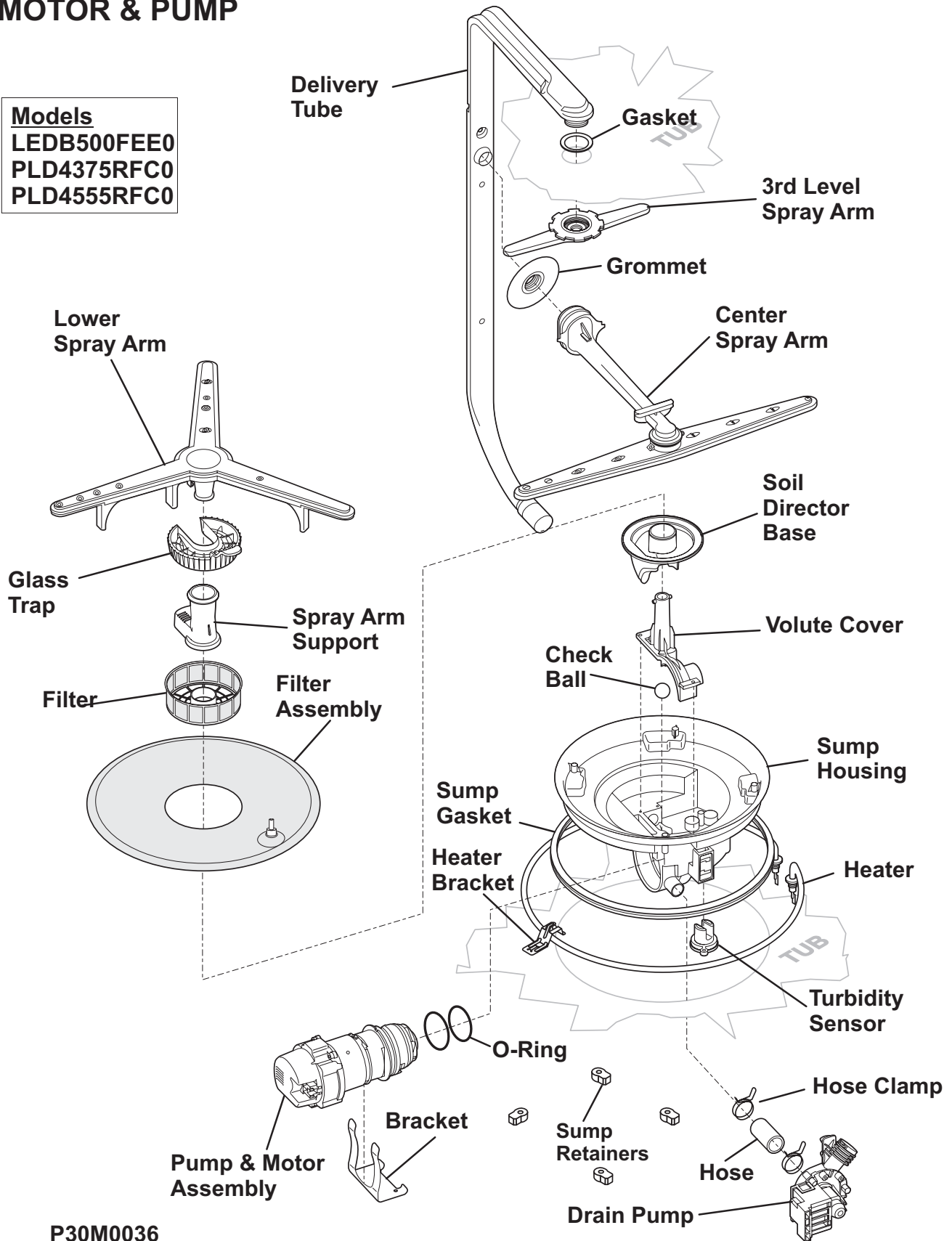

P30M0036

FRAME

Models
LEDB500FEE0
PLD4375RFC0
PLD4555RFC0

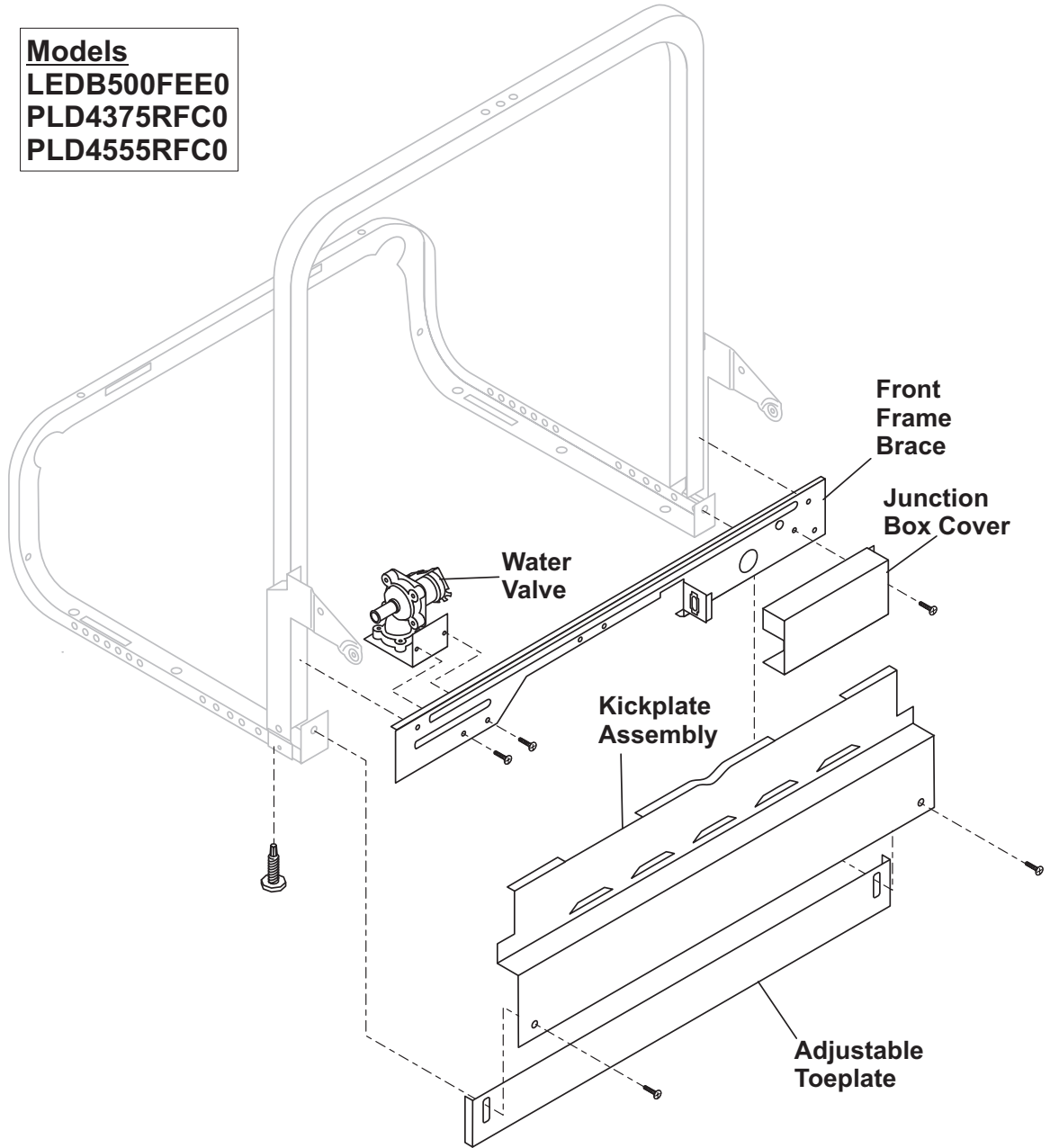

P30F0022

RACKS

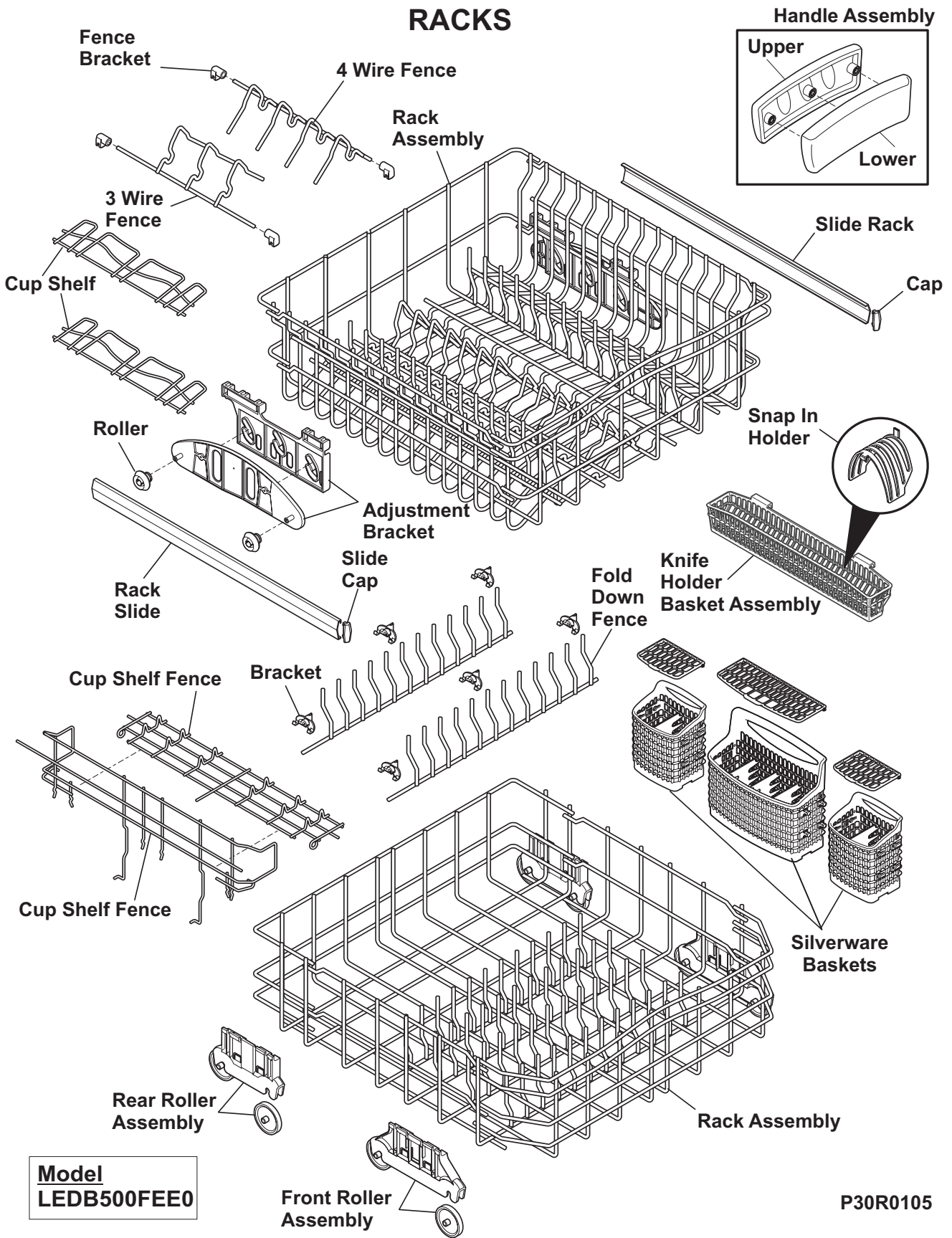

Model
LEDB500FEE0

P30R0105

RACKS

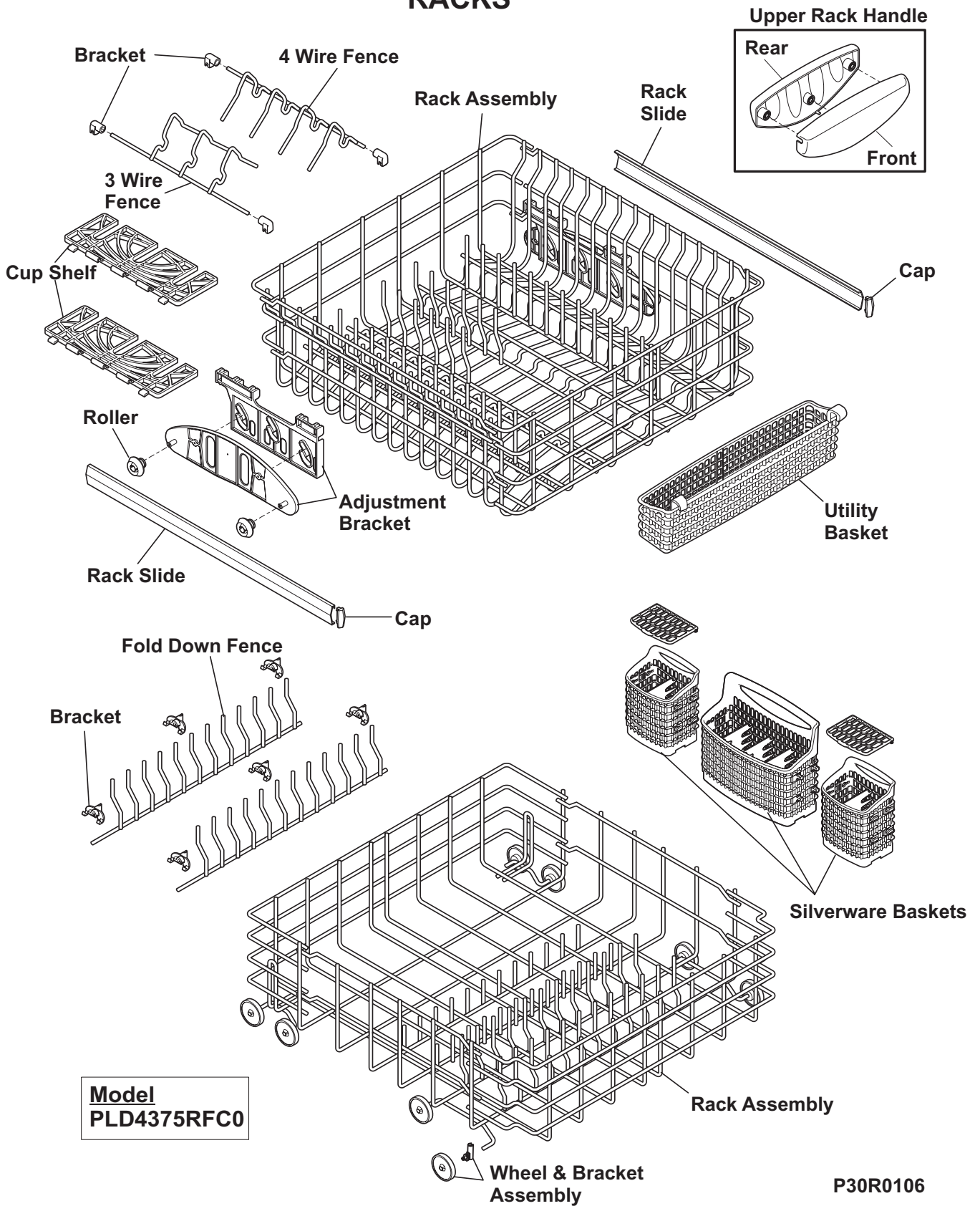

**Model
PLD4375RFC0**

P30R0106

RACKS

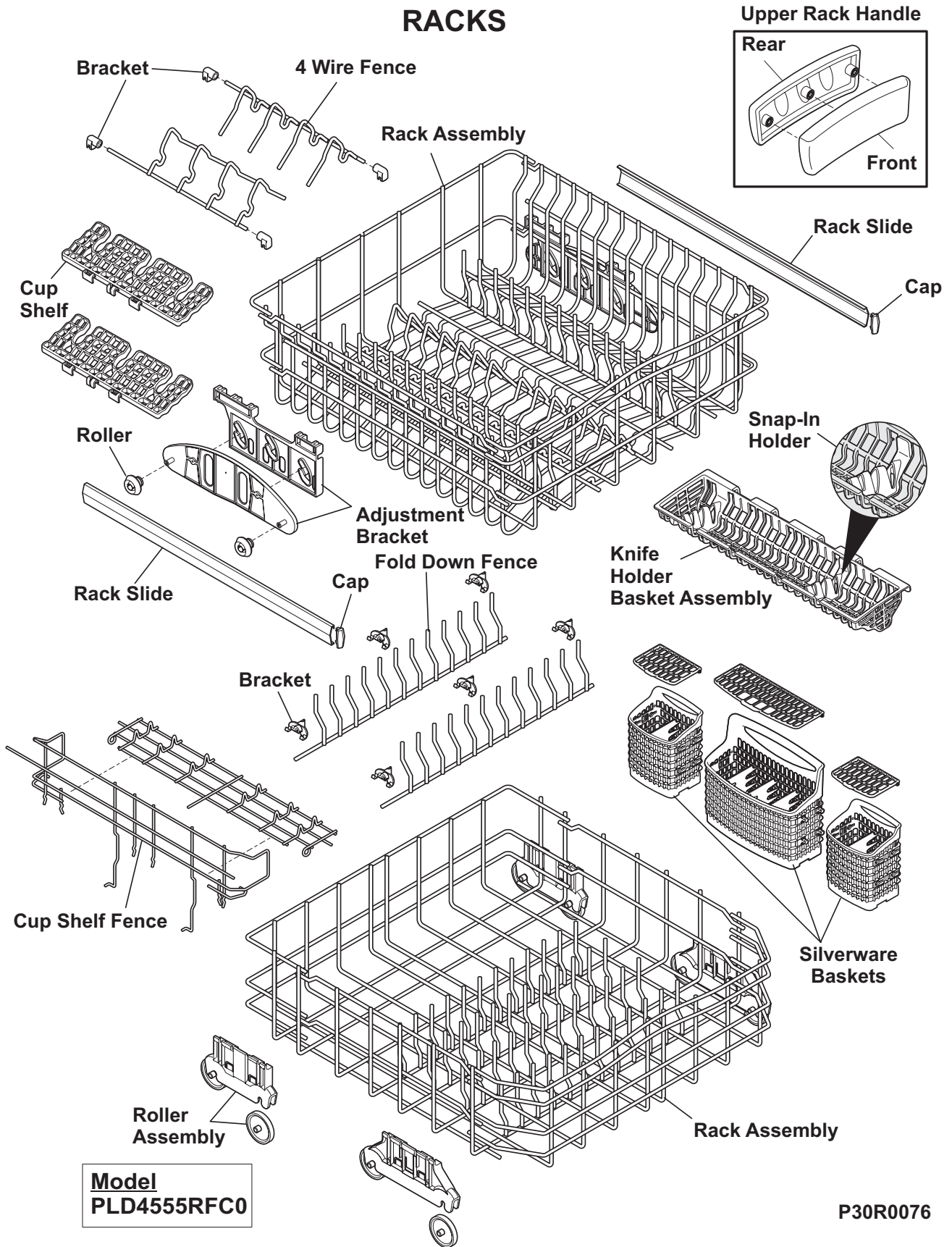

Model
PLD4555RFC0

P30R0076

SERVICE DATA SHEET

P/N: 154580201

Frigidaire
Electronic Series

This information is intended for use by persons having electrical and mechanical training and a level of knowledge of these subjects generally considered acceptable in the appliance repair trade. Electrolux Home Products North America cannot be responsible, nor assume any liability, for injury or damage of any kind arising from the use of this Service Data Sheet.

Operation

To start Close and latch door. Press START/CANCEL pad.

To delay start Close and latch door. Press DELAY START pad to select desired delay time.

To select a new cycle or option Press desired cycle and/or option pad. The indicator lights will change. Press START/CANCEL within 15 seconds to begin cycle.

To cancel cycle Press START/CANCEL. Dishwasher will drain for 90 seconds, then shut off.

For controls lock Press and hold the RINSE ONLY or AIR DRY pad for 3 seconds. To unlock, press and hold the RINSE ONLY or AIR DRY pad for 3 seconds.

Display Codes (Readout)

Low or **LO**.....Low liquid in the rinse aid dispenser

PF.....A power failure has occurred

HO.....Water heating delay

CL.....Close and latch the door

ER/ER.....Switch Failure

ER/CE.....Configuration Error

ER/uo.....Vent will not close

ER/uf.....Fan not running

'01-24.....Hour(s) delay before start (Some models)

Display Codes (LED)

SENSINGTurbidity sensor is checking the condition of the wash/rinse water. No sensing for LIGHT WASH (UPPER RACK), LIGHT WASH (LOWER RACK) and CHINA/CRYSTAL.

WASHINGWash portion of cycle.

SANITIZEDThe SANITIZED criteria has been met. Indicator light will switch off when door is opened.

DRYINGDrying portion of cycle.

CLEANShows completion of cycle. Indicator light will switch off when door is opened.

OPTION LED's Flashing -- HI-TEMP WASH and NO HEAT DRY/POWER DRY OFF LED's flashing indicates power failure has occurred. Press START/CANCEL pad and reselect desired options and cycle.

STATUS LED's Flashing -- The STATUS LED's that are lit when the door is opened will flash. Close door.

RINSE AGENT LOWThe liquid rinse agent is low. Light will switch off after 5 complete wash cycles or dispenser is filled. (Some models)

Color Code

BK.....Black
BU.....Blue
PK.....Pink
R.....Red
R-BK.....Red/Black
W.....White

Y-BK.....Yellow/Black
R-W.....Red/White
BK-W.....Black/White
R-Y.....Red/Yellow
VIO.....Violet

Water/Service Test

The water/service test is a special function initiated from the power failure mode or idle mode.

While in power failure or idle mode - simultaneously press the DRY/AIR DRY and START/CANCEL pads for 3 seconds.

The dishwasher will then step through the test cycle per the chart. Pushing the START/CANCEL pad will advance the dishwasher to the next step.

STEP	TOTAL TIME (SEC)	WATER VALVE	CIRCULATION MOTOR	DRAIN MOTOR	HEATER	DISPENSER	FAN UNIT	SENSING LED	WASHING LED	SANITIZED LED	DRYING LED	CLEAN LED	RINSE LED	Device being monitored	Display flashes when
1	FILL/DISPENSER	60	1	0	0	0	1	0	1	0	0	0	0	Fan damper	UC
2	FILL	27	1	0	0	0	0	1	1	0	0	0	0	Turbidity	TU
3	WASH/HEAT	45	0	1	0	1	0	0	1	1	0	0	0	Hall sensor	HS
4	PAUSE	0.4	0	0	0	1	0	0	1	1	0	0	0		
5	WASH/HEAT	75	0	1	0	1	0	0	0	0	0	0	1		
6	WASH/HEAT/DISP.	60	0	1	0	1	1	0	0	0	0	0	0	Thermistor	Th
7	DRAIN	90	0	0	1	0	0	1	0	0	0	0	0	Fan speed	UF
8	DRY	90	0	0	1	X	0	1	0	0	1	0	0	Rinse aid	RA
	TOTAL	447													

X - denotes selectable option

CLEAN LED stays on until door is opened or cycle is started.

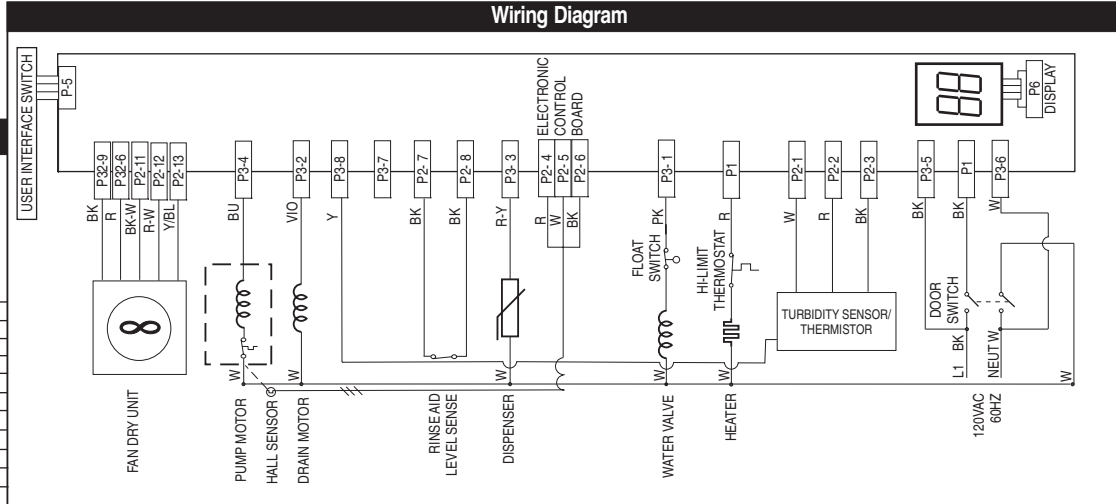

Cycle Selection Options

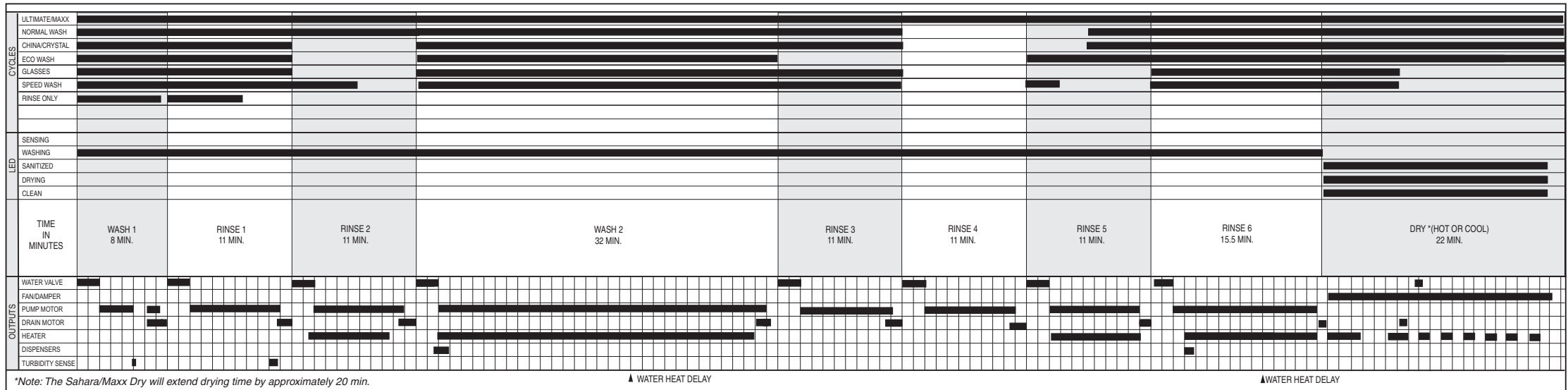

Exploded View of Wash System

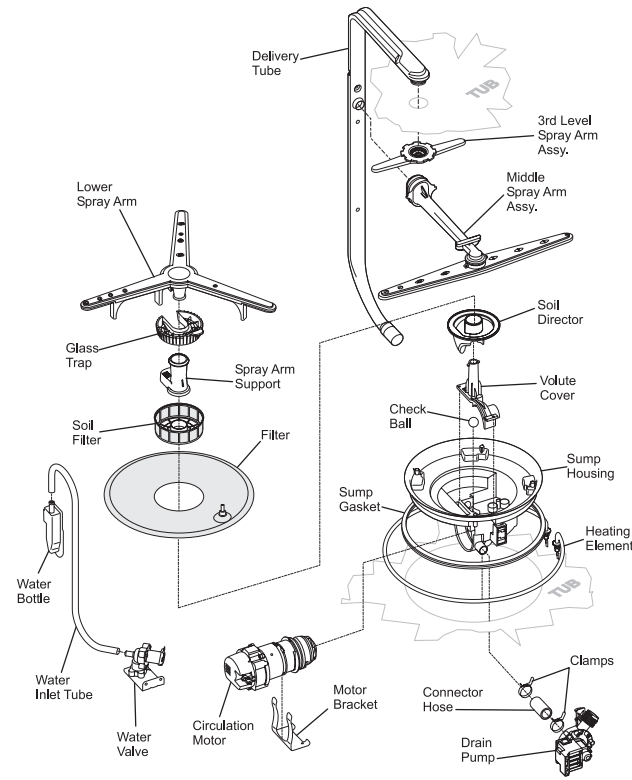

Pump Assembly

The pump assembly is driven by a synchronous motor. Rotation is in the counterclockwise direction at 3600 RPM. The motor drives a pump which supplies 100 percent filtered water at a rate of approximately 12 GPM to one spray arm at a time. The spray arm's operation is alternated by small "pauses" of the motor during the wash cycle.

Draining is accomplished by using a small separate synchronous drain pump mounted to the side of the sump. The drain pump is connected to the main pump by a small rubber hose. The drain check valve is located at the discharge end of the drain pump. The drain hose

is attached by a worm gear clamp to the discharge end of the drain pump.

The drain hose must have a loop at a **minimum height of 32 inches** in order to insure proper drainage.

The main pump can easily be removed by disconnecting the upper spray arm supply tube between the circulation motor, the water heat thermistor located on the bottom of the pump and rotating the four sump retainers toward the middle of the sump.

Standard Dry Air Flow

When the control advances to the "dry" portion of the cycle, a vent actuation solenoid is closed. This opens the vent valve and starts the vent fan both located in the top right rear corner of the tub. The fan draws in the air from outside the tub, forcing the hot, humid air down and out the

bottom of the outer door panel. This outside, cooler, dryer air helps to speed evaporation of water from the hot dishes. At the same time the heating element is continually cycled on and off. On some models the dry portion of the cycle can be extended to improve drying performance.

Detergent and Rinse Aid Dispenser

The detergent and rinse aid dispenser is a one piece component consisting of a molded detergent cup and a built-in rinse aid dispenser.

The detergent cup has a spring loaded cover and the rinse aid dispenser has a removable cover.

Liquid rinse aid is added to the dispenser up to the fill line indicator. The amount of rinse aid released can be adjusted by turning the arrow indicator from one, being the least amount, to four, being the greatest amount.

To replace dispenser:

- shut off electricity to dishwasher,
- remove outer door panel assembly,
- disconnect wiring to the actuator,
- remove the six screws,
- remove the dispenser,
- replace and reinstall screws,
- rewire actuator.

Tub and Door Seal

The door seal is pressed into the tub channel for an interference fit. To install the seal, locate the center mark on the seal back and press into place. Next, install the bottom of the seal by creating a short turn at the bottom of the tub channel and ensuring the seal extends to the

locator ridge at the bottom of the tub. Then align and gently press the seal into the channel in only a few spots. Next, close and latch the door to allow the gasket to seat properly into the channel.

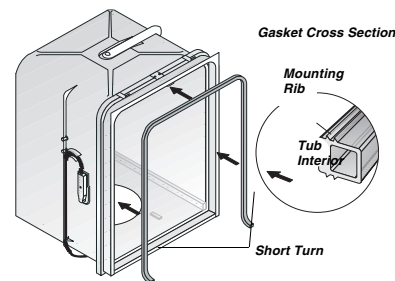

Product Specifications

Electrical

Rating	120 Volts, 60Hz
Separate Circuit15 amp min.- 20 amp max.
Motor (Amps)	1.8
Heater Wattage	900
Total Amps (load rated)	10.0
TempAssure	140°F ±5°F (60°C±3°C) [with outer door in place]
TempBoost	145°F ±5°F (63°C ±3°C)
	Heated Wash/Heated Rinse
Sanitize	150°F ±5°F (66°C ±3°C)
Hi-Limit Thermostat	200°F (93°C)

Water Supply

Suggested minimum incoming water temperature	120°F (49°C)
Pressure (PSI) min./max.	20/120
Connection (NPT)	³ / ₈ "
Consumption (Normal Cycle)	4.9 - 9.7 U.S. gal., 18.5 - 36.7 liters
Water valve flow rate (U.S. GPM)83
Water recirculation rate (U.S. GPM)	approx. 12
Water fill time	87 sec.

Trouble Shooting Tips

⚠ WARNING

Personal Injury Hazard

Always disconnect the dishwasher from the electrical power source before adjusting or replacing components.

Symptom	Check the Following	Remedy
Dishwasher will not operate when turned on.	<ol style="list-style-type: none"> 1. Fuse (blown or tripped). 2. 120 VAC supply wiring connection faulty. 3. Electronic control board defective. 4. No 12 VAC power to control. 5. Motor (inoperative). 6. Door switch (open contacts). 7. Door latch not making contact with door switch. 8. Touch pad circuit defective. 9. No indicator lamps illuminate when START or OPTIONS are pressed. 	<ol style="list-style-type: none"> 1. Replace fuse or reset breaker. 2. Repair or replace wire fasteners at dishwasher junction box. 3. Replace control board. 4. Replace control board. 5. Replace motor/impeller assembly. 6. Replace latch assembly. 7. Replace latch assembly. 8. Replace console assembly. 9. Replace console assembly.
Motor hums but will not start or run.	<ol style="list-style-type: none"> 1. Motor (bad bearings). 2. Motor stuck due to prolonged non-use. 	<ol style="list-style-type: none"> 1. Replace motor assembly. 2. Rotate motor impeller.
Motor trips out on internal thermal overload protector.	<ol style="list-style-type: none"> 1. Improper voltage. 2. Motor windings shorted. 3. Glass or foreign items in pump. 	<ol style="list-style-type: none"> 1. Check voltage. 2. Replace motor/impeller assembly. 3. Clean and clear blockage.
Dishwasher runs but will not heat.	<ol style="list-style-type: none"> 1. Heater element (open). 2. Electronic control board defective. 3. Wiring or terminal defective. 4. Hi-Limit thermostat defective. 	<ol style="list-style-type: none"> 1. Replace heater element. 2. Replace control board. 3. Repair or replace. 4. Replace thermostat.
Detergent cover will not latch or open.	<ol style="list-style-type: none"> 1. Latch mechanism defective. 2. Electronic control board defective. 3. Wiring or terminal defective. 4. Broken spring(s). 5. Defective actuator. 	<ol style="list-style-type: none"> 1. Replace dispenser. 2. Replace control board. 3. Repair or replace. 4. Replace dispenser. 5. Replace dispenser.
Dishwasher will not pump out.	<ol style="list-style-type: none"> 1. Drain restricted. 2. Electronic control board defective. 3. Defective drain pump. 4. Blocked impeller. 5. Open windings. 6. Wiring or terminal defective. 	<ol style="list-style-type: none"> 1. Clear restrictions. 2. Replace control board. 3. Replace pump. 4. Check for blockage, clear. 5. Replace pump assembly. 6. Repair or replace.
Dishwasher will not fill with water.	<ol style="list-style-type: none"> 1. Water supply turned off. 2. Defective water inlet fill valve. 3. Check fill valve screen for obstructions. 4. Defective float switch. 5. Electronic control board defective. 6. Wiring or terminal defective. 7. Float stuck in "UP" position. 	<ol style="list-style-type: none"> 1. Turn water supply on. 2. Replace water inlet fill valve. 3. Disassemble and clean screen. 4. Repair or replace. 5. Replace control board. 6. Repair or replace. 7. Clean float.
Dishwasher water siphons out.	<ol style="list-style-type: none"> 1. Drain hose (high) loop too low. 2. Drain line connected to a floor drain not vented. 	<ol style="list-style-type: none"> 1. Repair to proper 32-inch minimum height. 2. Install air gap at counter top.

Detergent left in dispenser.

- | | |
|---|---|
| <ol style="list-style-type: none"> 1. Detergent allowed to stand too long in dispenser. 2. Dispenser wet when detergent was added. 3. Detergent cover held closed or blocked by large dishes. 4. Improper incoming water temperature to properly dissolve detergent. 5. See "Detergent cover will not open." | <ol style="list-style-type: none"> 1. Instruct customer/user. 2. Instruct customer/user. 3. Instruct customer/user on proper loading of dishes. 4. Incoming water temperature of 120°F is required to properly dissolve dishwashing detergents. |
|---|---|