



CONSUMER SERVICES TECHNICAL  
EDUCATION GROUP PRESENTS

**KM-26**

# MICROWAVE CONVECTION OVEN



JOB AID  
Part No. 8177972

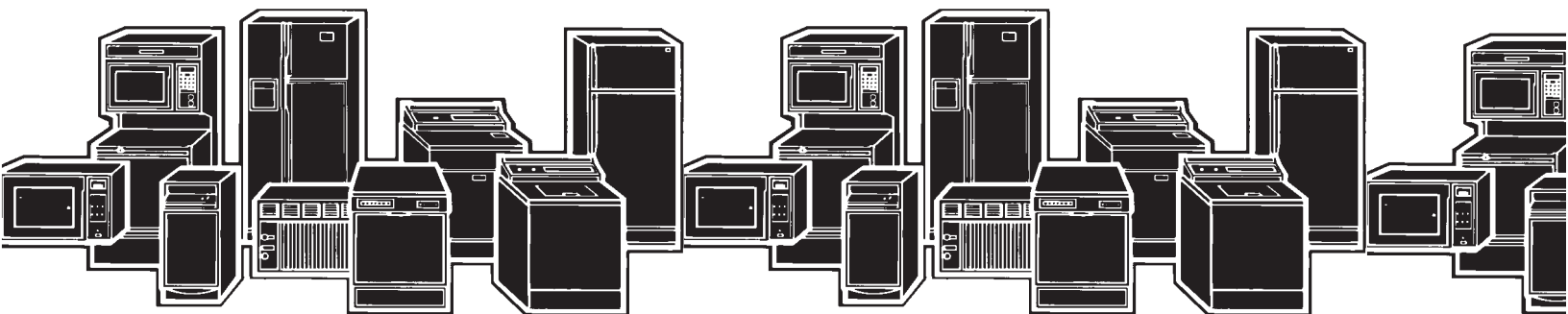

## FORWARD

This Job Aid, "Whirlpool Microwave-Convection Oven," (Part No. 8177972), provides the technician with information on the installation and service of the Whirlpool Microwave-Convection Oven. It is to be used as a training Job Aid and Service Manual. For specific information on the model being serviced, refer to the "Use and Care Guide," or "Tech Sheet" provided with the microwave oven.

The Wiring Diagrams and Strip Circuits used in this Job Aid are typical and should be used for training purposes only. Always use the Wiring Diagram supplied with the product when servicing the unit.

## GOALS AND OBJECTIVES

The goal of this Job Aid is to provide detailed information that will enable the service technician to properly diagnose malfunctions and repair the Microwave-Convection Oven.

The objectives of this Job Aid are to:

- Understand and follow proper safety precautions.
- Successfully troubleshoot and diagnose malfunctions.
- Successfully perform necessary repairs.
- Successfully return the microwave oven to proper operational status.

**WHIRLPOOL CORPORATION assumes no responsibility for any repair made on our products by anyone other than Authorized Factory Service Technicians.**

Copyright 2000, Whirlpool Corporation, Benton Harbor, MI 49022

# Table of Contents

	Page
SPECIFICATIONS .....	1-1
COMPONENT ACCESS .....	2-1
Microwave Oven Component Locations .....	2-1
Removing The Microwave Oven Cabinet .....	2-2
Removing The Electronic Oven Control .....	2-3
Removing The Door Interlock Switches .....	2-5
Removing The Humidity Sensor .....	2-7
Removing The Oven Lamp, The Damper Motor, & Damper Switch .....	2-8
Removing The Oven Thermostat .....	2-9
Removing The Magnetron .....	2-10
Removing The High Voltage Transformer .....	2-11
Removing The Line Fuse & Fuseholder .....	2-12
Removing The High Voltage Rectifier, The High Voltage Capacitor, And The Fan Motor .....	2-13
Removing The Convection Thermistor, Circulation Motor, & Convection Element .....	2-15
Removing The Turntable Motor .....	2-18
Removing The Oven Door, The Switch Actuators, And The Outer Glass .....	2-19
COMPONENT TESTING .....	3-1
The Turntable And Damper Motors .....	3-1
The Fan And Circulation Motors .....	3-2
The Line Fuse, High Voltage Rectifier (Diode), & High Voltage Capacitor .....	3-3
The Convection Element & Humidity Sensor .....	3-4
The Convection Thermistor And Oven Thermostat .....	3-5
The Magnetron & High Voltage Transformer .....	3-6
The Damper & Door Interlock Switches .....	3-7
DIAGNOSIS & TROUBLESHOOTING .....	4-1
Touch Panel Continuity Test .....	4-1
Microwave Oven Power Output Test .....	4-1
Troubleshooting Chart .....	4-2
WIRING DIAGRAM & STRIP CIRCUITS .....	5-1
TECH TIPS .....	6-1

# WHIRLPOOL MODEL & SERIAL NUMBER DESIGNATIONS

## MODEL NUMBER

<b>MODEL NUMBER</b>		<b>G</b>	<b>M</b>	<b>8</b>	<b>15</b>	<b>5</b>	<b>X</b>	<b>J</b>	<b>Q</b>	<b>0</b>
<b>INTERNATIONAL SALES IND. OR MARKETING CHANNEL IF PRESENT</b>										
<b>PRODUCT GROUP</b> G = WHIRLPOOL GOLD M = MICROWAVE										
<b>PRODUCT IDENTIFICATION</b> B = BROWNER C = CONVECTION G = GRILL / CRISPER H = OTR HOOD COMBO K = KITS M = GOLD CONVECTION S = STIRRER FAN T = TURNTABLE										
<b>MODEL VARIATIONS</b> 0 - 9										
<b>CUBIC FEET</b> 04 = .4 CU. FT.    10 = 1.0 CU. FT. 06 = .6 CU. FT.    12 = 1.2 CU. FT. 07 = .7 CU. FT.    14 = 1.4 CU. FT. 08 = .8 CU. FT.    15 = 1.5 CU. FT. 09 = .9 CU. FT.    16 = 1.6 CU. FT.										
<b>FEATURE LEVEL</b> 0 = 30" KIT (IF KIT) 2 = 22" KIT (IF KIT) 4 = 24" KIT (IF KIT) 5 = SENSORED MODEL 7 = 27" KIT (IF KIT)										
<b>FEATURE CODE</b> C = CSA APPROVED S = CARRY IN WARRANTY (EFFECTIVE 02/96) X = IN HOME WARRANTY (EFFECTIVE 02/96)										
<b>YEAR OF INTRODUCTION</b> J = 2000, K = 2001, L = 2002										
<b>COLOR CODE</b> B = BLACK, Q = WHITE, T = BISCUIT										
<b>ENGINEERING CHANGE (0, 1, 2, ETC.)</b>										

## SERIAL NUMBER

<b>SERIAL NUMBER</b>	<b>FG</b>	<b>K</b>	<b>23</b>	<b>10202</b>
<b>MANUFACTURER</b> FG = GOLDSTAR				
<b>YEAR OF PRODUCTION</b> K = 2000				
<b>WEEK OF PRODUCTION</b> 23rd WEEK				
<b>PRODUCT SEQUENCE NUMBER</b>				

# MODEL & SERIAL NUMBER LABEL AND TECH SHEET LOCATIONS

The Model/Serial Number label and Tech Sheet locations are shown below.

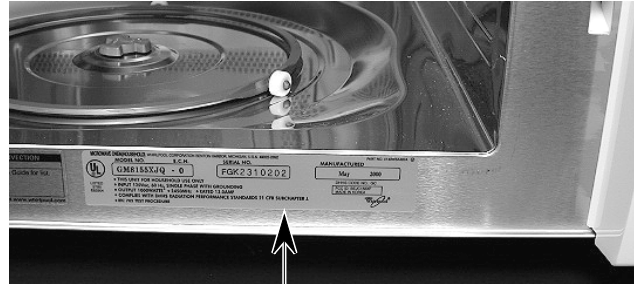

**Model & Serial  
Number Location**

**Tech Sheet Location**

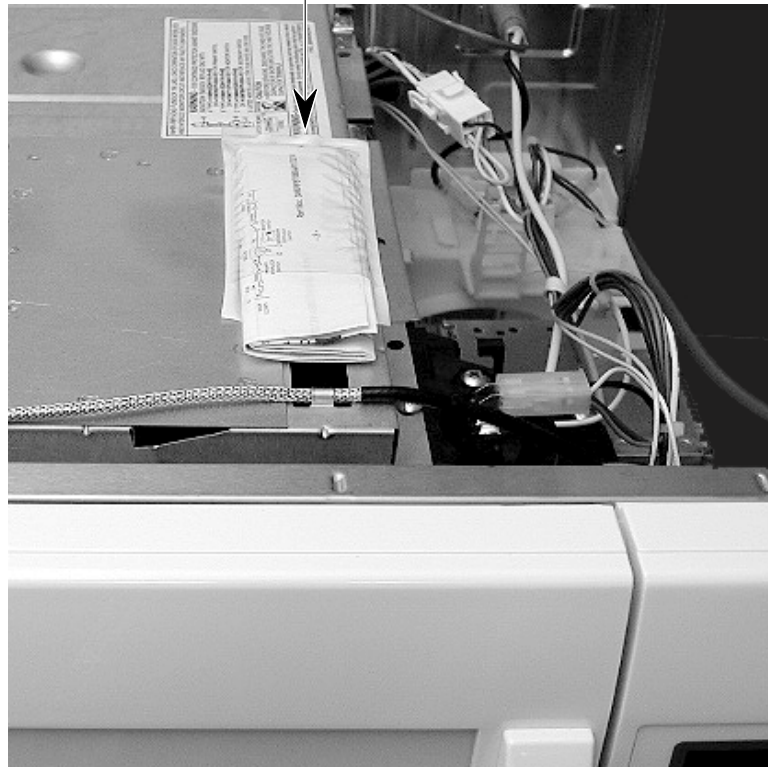

# IMPORTANT SAFETY INFORMATION

## Your safety and the safety of others is very important.

Important safety messages have been provided in this Job Aid. Always read and obey all safety messages.



This is the safety alert symbol.

This symbol alerts you to hazards that can kill or hurt you and others.

All safety messages will be preceded by the safety alert symbol and the word **“WARNING.”**

All safety messages will identify the hazard, tell you how to reduce the chance of injury, and tell you what can happen if the instructions are not followed.

## Grounding Instructions

### CORD CONNECTED

The microwave oven must be grounded. In the event of an electrical short circuit, grounding reduces the risk of electric shock by providing an escape wire for the electrical current. The microwave oven is equipped with a cord having a grounding wire with a grounding plug. The plug must be plugged into an outlet that is properly installed and grounded.



Improper use of the grounding plug can result in a risk of electric shock.

Consult a qualified electrician or serviceman if the grounding instructions are not completely understood, or if doubt exists as to whether the microwave oven is properly grounded. Do not use an extension cord. If the power supply cord is too short, have a qualified electrician or serviceman install an outlet near the microwave oven.

### PERMANENTLY CONNECTED

The microwave oven must be connected to a grounded, metallic, permanent wiring system, or an equipment grounding conductor should be run with the circuit conductors and connected to the equipment grounding terminal, or lead, on the microwave oven.

## Warning To Service Technicians

To avoid possible exposure to microwave radiation or energy, visually check the oven for damage to the door and door seal before operating any oven. Use a microwave survey meter to check the amount of leakage before servicing. In the event the R.F. leakage exceeds 4 mw/cm<sup>2</sup> at 5 cm, appropriate repair must be made before continuing to service the unit. Check interlock function by operating the door latch. The oven cook cycle should cut off before the door can be opened.

The door and latching assembly contains the radio frequency energy within the oven. The door is protected by three safety interlock switches. Do not attempt to defeat them.

**UNDER NO CIRCUMSTANCES SHOULD YOU TRY TO OPERATE THE OVEN WITH THE DOOR OPEN.**

- Proper operation of microwave ovens requires that the magnetron be properly assembled to the waveguide and cavity. Never operate the magnetron unless it is properly installed.
- Be sure the “RF” seal is not damaged and is assembled around the magnetron dome properly when installing the magnetron.
- Routine service safety procedures should be exercised at all times.
- Untrained personnel should not attempt service without a thorough review of test procedures and safety information contained in this Job Aid.

Whirlpool microwave ovens have a monitoring system designed to assure proper operation of the safety interlock systems.

The interlock monitor switch will immediately cause the oven fuse to blow if the door is opened and the primary door interlock switch and/or the secondary interlock switch contacts fail in a closed position.

**CAUTION: REPLACE BLOWN FUSE WITH 20 AMPERE CLASS H FUSE ONLY**

Test the upper and lower door interlock switches, cook relay and interlock monitor switch (middle switch) for proper operation as described in the component test procedures, before replacing the blown oven fuse.

**DO NOT ATTEMPT TO REPAIR STICKING CONTACTS OF ANY INTERLOCK SWITCH, SAFETY SWITCH OR COOK (LATCH) RELAY. THE COMPONENTS MUST BE REPLACED.**

Any indication of sticking contacts during component tests requires replacement of that component to assure reliability of the safety interlock system.

**IF THE FUSE IS BLOWN, THE MONITOR, PRIMARY, AND SECONDARY INTERLOCK SWITCHES MUST BE REPLACED. BE SURE THEY ARE PROPERLY CONNECTED.**

## **Precautions To Be Observed Before And During Servicing To Avoid Possible Exposure To Excessive Microwave Energy**

1. Do not operate or allow the oven to be operated with the door open.
2. Make the following safety checks on all ovens to be serviced before activating the magnetron or other microwave source and make repairs as necessary.
  - a) Interlock Operation
  - b) Proper Door Closing
  - c) Seal and Sealing Surfaces (Arcing, Wear and Other Damage)
  - d) Damage to or Loosening of Hinges and Latches
  - e) Evidence of Dropping or Abuse
3. Before turning on the microwave power for any service test or inspection within the microwave generating components, check the magnetron, wave guide or transmission line and cavity for proper alignment.
4. Any defective or misadjusted components in the interlock, monitor, door seal and microwave generation and transmission system shall be repaired by procedures described in the Job Aid for the specific microwave oven being serviced before the oven is released to the owner.
5. A microwave leakage check to verify compliance with Federal Performance Standards should be performed on each oven prior to release to the owner.
6. Do not attempt to operate the oven if the door glass is broken.



## CAUTION

- High voltages are present during the cook cycle. Extreme caution should be observed at all times.
- Abrasive cleansers, steel-wool pads, gritty wash cloths, etc. can damage the control panel and the interior and exterior oven surfaces. Use a sponge with mild detergent or paper towels with spray glass cleaner. Apply spray glass cleaner to paper towel. Do not spray directly on oven.
- Before touching any oven component or wiring, always unplug the oven from its power source and discharge the capacitor by using a 20,000 ohm discharge resistor or use an insulated plastic handle screwdriver to short across the capacitor terminals.
- Check that the unit is grounded before troubleshooting. Be careful of the high voltage circuits. Discharge any static charge from your body by touching ground before handling any part of the circuitry on the control board. Electrostatic discharge may damage the control circuit.
- Do not touch oven components or wiring during operation. Attach meter leads with alligator clips when making operational tests.
- For continued protection against radiation emission, replace only with these types of switches: Primary (Interlock) Switch: SZM-V16-FA-63 or VP-533A-OF; Secondary (Interlock) Switch: SZM-V01-FA-32; Interlock (Monitor) Switch: SZM-VI6-FA-62 or VP-532A-OF; Oven Lamp Switch: SZM-V6-FA-31 or VP-331 A-OD.
- It is neither necessary nor advisable to attempt measurement of high voltage.
- Attaching the adaptor ground terminal to the wall receptacle cover screw does not ground the appliance unless the cover screw is metal and not insulated and the wall receptacle is grounded through the house wiring.

## WARNING

- Disconnect the oven from electrical supply before servicing. Failure to do so could result in electrical shock or death.
- Improper use of the grounding plug can result in a risk of electrical shock. Do not, under any circumstance, cut or remove the third ground prong from the power cord plug.

### **Fire, Electrical Shock, Excessive Exposure to Microwave Energy, Personal Injury & Product Damage Hazard**

- Do not block the rear air intake openings or exhaust vents. Allow a few inches of space at the back of the oven where intake openings and exhaust vents are located. Blocking the air intake openings and exhaust vents can cause damage to the oven and poor cooking results.

### **Electrostatic Discharge (ESD) Sensitive Electronics**

ESD problems are present everywhere. ESD may damage or weaken the electronic control assembly. The new control assembly may appear to work well after repair is finished, but failure may occur at a later date due to ESD stress.

- Use an antistatic wrist strap. Connect wrist strap to green ground connection point or unpainted metal in the appliance, or touch your finger repeatedly to a green ground connection point or unpainted metal in the appliance.
- Before removing the part from its package, touch the antistatic bag to a green ground connection point or unpainted metal in the appliance.
- Avoid touching electronic parts or terminal contacts; handle electronic control assembly by the edges only.
- When repackaging failed electronic control assembly in antistatic bag, observe above instructions.

# R.F. LEAKAGE TEST

## EQUIPMENT

- Electromagnetic energy leakage monitor (NARDA 81 00B, HOLADAY H 1 501 ).
- 250 ml glass beaker.

## TEST

On every service call, checks for microwave energy emission must be made according to the following manner.

1. Remove the cooking rack from the oven cavity, if the microwave oven is so equipped.
2. Place a 250 ML (8.0 oz.) glass of water in the center of the oven bottom.
3. Select "HIGH" cook power, turn the microwave oven on, and test for R.F. leakage at the following locations using the pattern shown below:
  - a) Around the cabinet at the front.
  - b) Around the door.
  - c) Across the console panel.
  - d) Horizontally across the door.
  - e) Vertically across the door.
  - f) Diagonally across the door.
  - g) Across the air vents.
  - h) Across the rear air vent.
  - i) All lockseams.
  - j) Weld at bottom.
  - k) Bottom plate.
  - l) Oven feet.
4. The scan speed is one inch per second.

When checking for R.F. leakage, use an approved R.F. measuring device to assure less than 4 mw/cm<sup>2</sup> emission at 5 cm distance with a maximum scan rate of 2.5 cm/second, in

compliance with U.S. Government Department of Health, Education and Welfare 21 CFR1030, performance Standard for Microwave Ovens.

A properly operating door and seal assembly will normally register small emissions, but they must be no greater than 4 mw/cm<sup>2</sup> to allow for measurement uncertainty.

NOTE: Enter leakage readings in space BEFORE and AFTER on the service document.

All microwave ovens exceeding the emission level of 4 mw/cm<sup>2</sup> must be reported to Dept. of Service for microwave ovens immediately and the owner should be told not to use the microwave oven until it has been repaired completely.

If a microwave oven is found to operate with the door open, report to Dept. of Service, the manufacturer and CDRH\* immediately. Also tell the owner not to use the oven.

The interlock monitor switch acts as the final safety switch protecting the customer from microwave radiation. If the interlock monitor switch operated to blow the fuse when the interlocks failed, you must replace all interlock switches with new ones, because the contacts of those interlock switches may be melted and welded together.

All repairs must be performed in such a manner that microwave energy emissions are minimal.

Address for CDRH is:

**Office of Compliance (HFZ-312) Center  
for Devices and Radiological Health  
1390 Piccard Drive  
Rockville, Maryland 20850**

\* CDRH: Center for Device and Radiological Health, Food and Drug Administration.

# SPECIFICATIONS

Specifications / Model No.	GM8155XJQ/B/T
Colors	White/Black/Biscuit
Size - Cavity	1.5 cu. Feet
Sensor	Yes
Brand	Whirlpool Gold
<b>CONTROL SYSTEM</b>	
Timer	Yes
Type	Electronic
Limits	99 Min./59 Sec.
Display	7 Digit Red and Blue-Green Fluorescent
<b>MICROWAVE SYSTEM</b>	
Distribution	Maxwave (circular)
Magnetron	Ceramic Dome, Horizontally Cooled with Ferrite Magnets
<b>OVEN INTERIOR FEATURES</b>	
Size	15 1/4" W x 10 7/8" H x 15 1/4" D
Capacity	1.5 Cubic Feet
Finish	Stainless Steel
Microwave Cooking Power	1000 Watts (IEC-705 Test)
Convection Heater	1500 watts
Grill Heater	No
Ventilation	Forced Air
Turntable	Removable Glass
Diameter	12 3/4" (324 mm)
Stoppable	No
Convection Bake Rack (short)	Yes
Drip Pan	Yes
Light	Automatic - Turns on when door is open, or oven is operating. 30 watt extended life
<b>MICROWAVE COOKING CYCLES</b>	
Sensor Popcorn	Yes
Auto Defrost	Yes
Sensor Cook	Yes
<b>CONVECTION COOKING CYCLES - Manual</b>	
Convection	Yes
Grill / Broil	No
<b>CONVECTION COOKING CYCLES - Auto Cook *** Whirlpool Corporate Exclusive ***</b>	
Auto Convection Recipes	41 Recipes using optimal combination of Convection and / or Microwaves
Meat	8 options
Doneness Selection	Auto-Convection Meat category only (Rare, Med-Rare, Med, Med-Well, Well)
Poultry	6 options
Fish	5 options
Baked Goods	9 options
Other Dishes	7 options
Snack Foods	6 options
<b>OPERATING FEATURES</b>	
Minute Timer	Independent & Concurrent
Add Time	JETStart (30 Seconds)
Cook Time	Yes
Warm Hold	Yes
Staged Cooking	3 Stages (Defrost or Warm Hold, Cook 1 - 2)
Child Lock	Yes - Off key for 4 seconds
Options / Personal Choice:	
Sound Volume	Low / Med / High / Off
Weight Preference	Lbs / Kg
Language	Trilingual (English/French/Spanish)
Clock	12 hr / 24 hr / off
Sales Demo Mode	Yes - On / Off
Microwave Variable Power	Yes
Type	Electronic
Range	10% - 100%
Scale	Digital
Levels	Ten
Convection Variable Power	Yes
Range	100, 225-450 F
Increments	5 degrees F
In-Use Reprogramming	Yes - Directional Arrows, Jet Start
Start/Enter	Yes - Jet Start
Off/Cancel	Yes
End-of-Cooking Reminder	3 tones
Power Failure Indication	Yes - Colon " : "
Error Indication	(Tones & "Error")
Audible Signals	Yes
Programming Tone	Yes

## Specifications (Continued)

GM8155XJQ/B/T	
<b>EXTERIOR FEATURES</b>	
Outside Dimensions	22 5/8" W x 14 7/8" H x 20" D
Construction	Wrap-Around Cabinet
Power Cord Length / Type	44" - 90 degree angle
<b>DOOR FEATURES</b>	
Outer Door	Stamped steel
Window Size	12.8" W x 8.5" H
Side Swing or Pull Down Door?	Side Swing
Door Handle/Push Button	Door Handle - Pull out
Seals	Two stage (capacitive & reflective)
<b>SAFETY FEATURES</b>	
Interlock	Three door/latch operated switches (1 primary, 1 monitor, 1 secondary)
Thermal Protectors	One (1 oven cavity)
<b>OTHER SPECIFICATIONS</b>	
Electrical	120 Volt, Single Phase, 60 Hz, 1500 Watts, for use with 20 Amp Circuit
Residential Use Only	Yes
Agency Approvals	FCC, CDRH (DHHS), U.L. listed
Full Warranty	One Year - In-Home
Limited Addl Warranty on Magnetron	4 Years Additional In-Home (2nd-5th year)
Model/Serial Plate Location	Front Plate - Lower Left
Cook Guide Location	Front Frame
Approx. Net Weight (Lbs.)	52 lbs
<b>ACCESSORIES</b>	
UTC Kit	No
Over Heat Source	Yes
Trim Kit - 27"	MK1157XJQ (8172230), MK1157XJB (8172231), MK1157XJT (8172232), MK1157XJS (8172233)
Trim Kit - 30"	MK1150XJQ (8172226), MK1150XJB (8172227), MK1150XJT (8172228), MK1150XJS (8172229)
<b>LITERATURE</b>	
Use and Care Guide - English & Spanish	8172190 / 3828W5A1491
Cooking Guide - English	8172205 / 3850W3D052A
Cooking Guide - Spanish	8172222 / 3850W3D052B
Installation Instructions	8172219 / 3828W5U078
Template for Built-in Kits	8172220 / 4922W5A012A
Tech Sheet	8172214 / 3840W5T089A

# COMPONENT ACCESS

This section instructs you on how to service each component inside the Model GM8155XJ Microwave Convection Oven. The components and their locations are shown below.

## MICROWAVE OVEN COMPONENT LOCATIONS

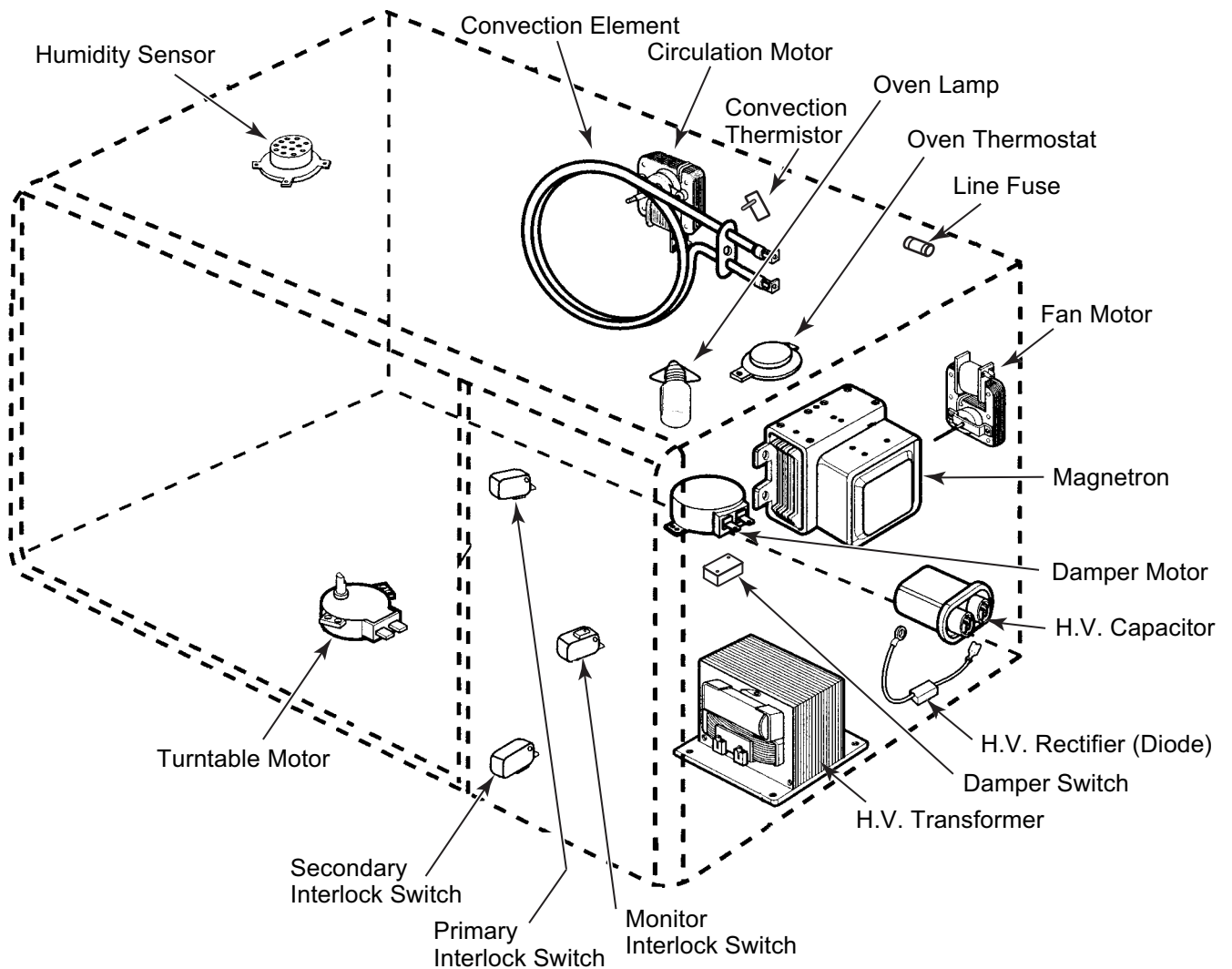

## REMOVING THE MICROWAVE OVEN CABINET

### **! WARNING**

#### **Electrical Shock Hazard**

Disconnect power before servicing.  
Replace all panels before operating.  
Failure to do so could result in death or electrical shock.

**CAUTION:** When you work on the microwave oven, be careful when handling the sheet metal parts. Sharp edges may be present, and you can cut yourself if you are not careful.

1. Disconnect the electrical power to the microwave oven.
2. Open the microwave oven door and remove the glass turntable and roller assembly from inside the oven cavity, then close the door.



Turntable & Roller Assembly

3. Remove the five rear flange screws and the two right side screws from the microwave oven cabinet. NOTE: The two bottom flange screws are T-20 tamper-resistant torx screws.

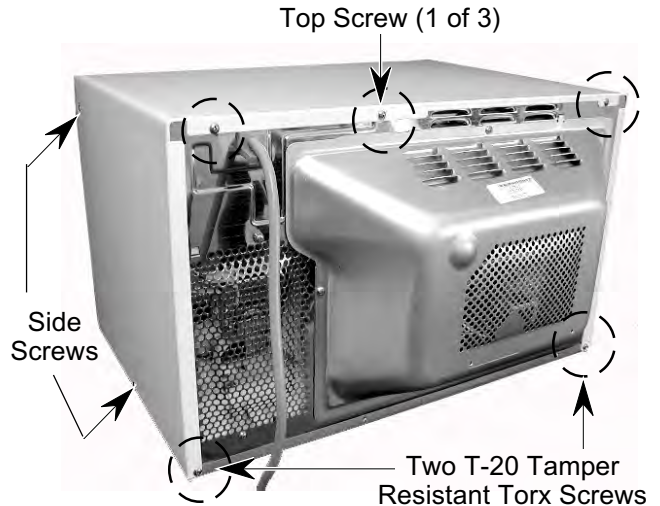

4. Pull the cabinet back, unhook it from the sides and top of the front panel, and remove the cabinet.



Unhook From Front Panel

# REMOVING THE ELECTRONIC OVEN CONTROL

## **! WARNING**

### **Electrical Shock Hazard**

Disconnect power before servicing.  
Replace all panels before operating.  
Failure to do so could result in death or electrical shock.

**CAUTION:** When you work on the microwave oven, be careful when handling the sheet metal parts. Sharp edges may be present, and you can cut yourself if you are not careful.

1. Disconnect the electrical power to the microwave oven.
2. Remove the cabinet from the microwave oven (see page 2-2 for the procedure).
3. Remove the screw from the top of the electronic oven control (EOC).

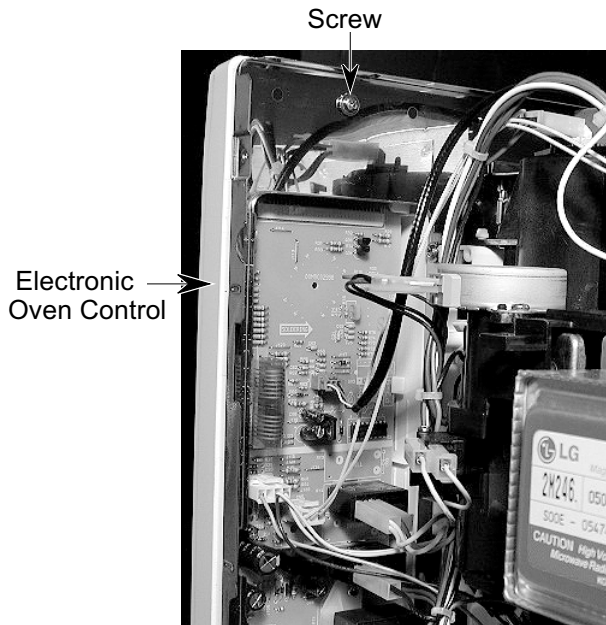

4. Open the microwave oven door.

5. From the front of the unit, slide the electronic oven control up, unhook the four side tabs from the chassis slots, and pull the EOC forward.

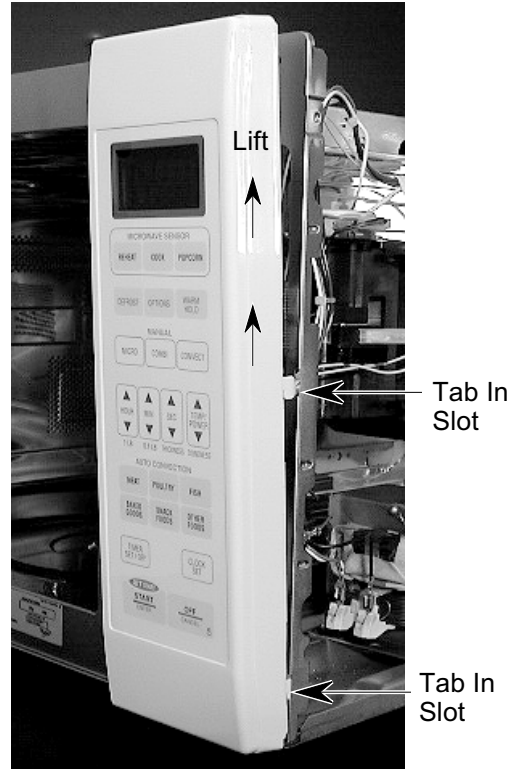

6. Disconnect the wire connectors from the EOC board.
7. To remove the circuit board from the EOC panel:
  - a) Lift the locking ring and remove the end of the ribbon cable from connector CN3.

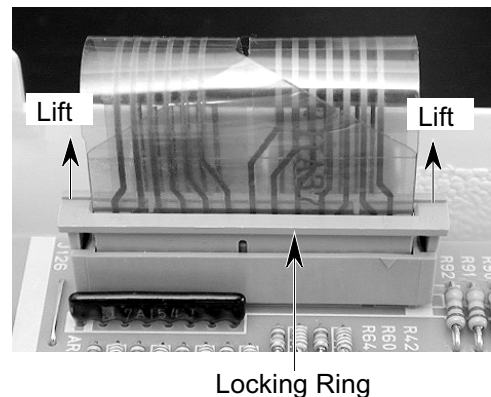

Continued on the next page.

b) Remove the three screws and unclip the board from the two locking arms.

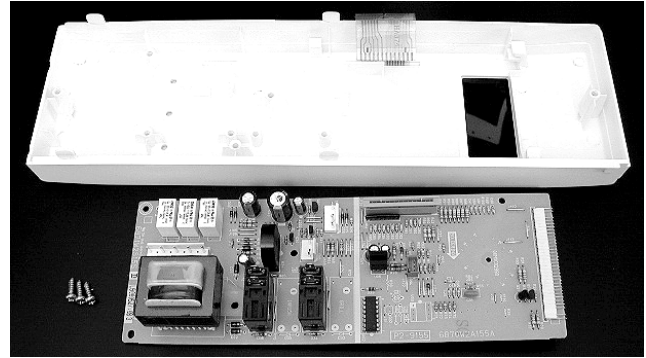
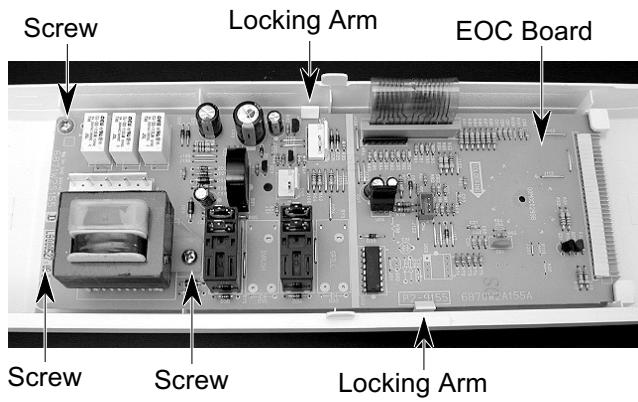



# REMOVING THE DOOR INTERLOCK SWITCHES

## **! WARNING**

### **Electrical Shock Hazard**

Disconnect power before servicing.  
Replace all panels before operating.  
Failure to do so could result in death or electrical shock.

**CAUTION:** When you work on the microwave oven, be careful when handling the sheet metal parts. Sharp edges may be present, and you can cut yourself if you are not careful.

1. Disconnect the electrical power to the microwave oven.
2. Remove the cabinet from the microwave oven (see page 2-2 for the procedure).

**CAUTION:** The three door interlock switches are mounted in a plastic holder (see below). The locking arms that hold the switches in place are easily broken if bent too far. Do not overbend the arms.

**NOTE:** You may find it easier to service the door switches with the electronic oven control removed. The procedure is shown on page 2-3.

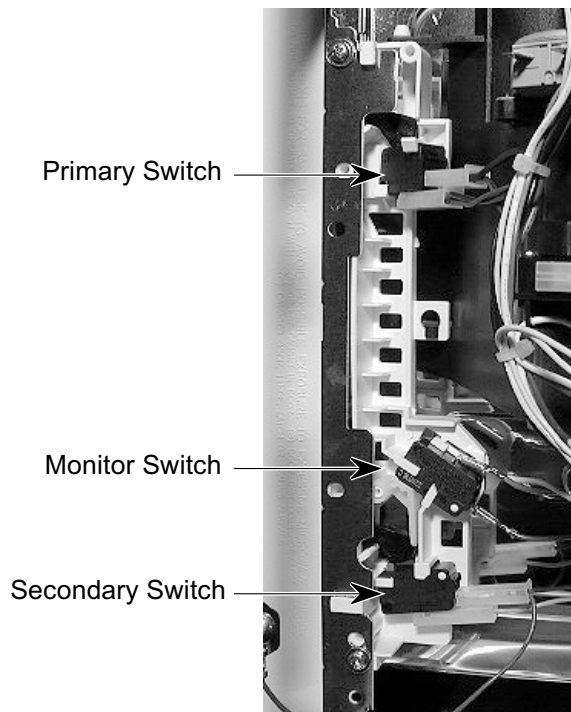

3. To remove the primary door interlock switch:

- a) Disconnect the wire connector from the terminals.

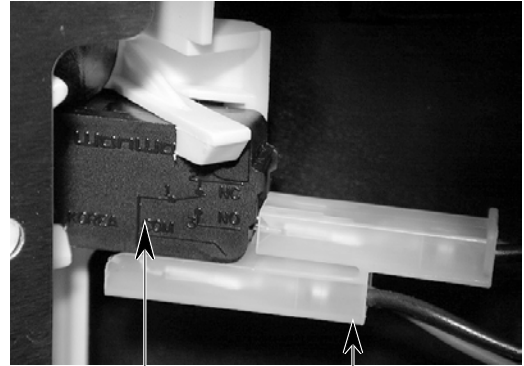

Primary (Top) Door Switch      Wire Connector

- b) Carefully pull out on the switch while you raise the locking arm, and remove the switch from the plastic holder.

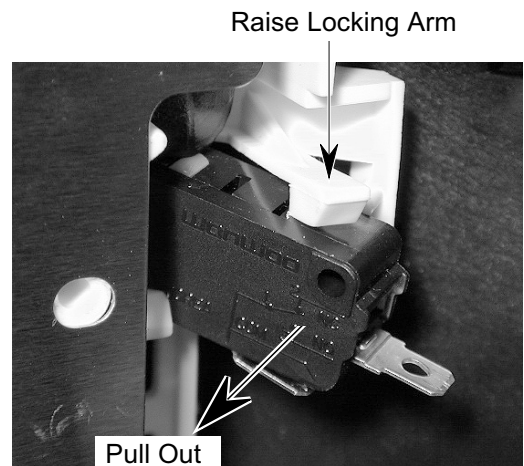

**Continued on the next page.**

4. **To remove the monitor or secondary door interlock switch:**

- a) Disconnect the wire connector from the terminals.

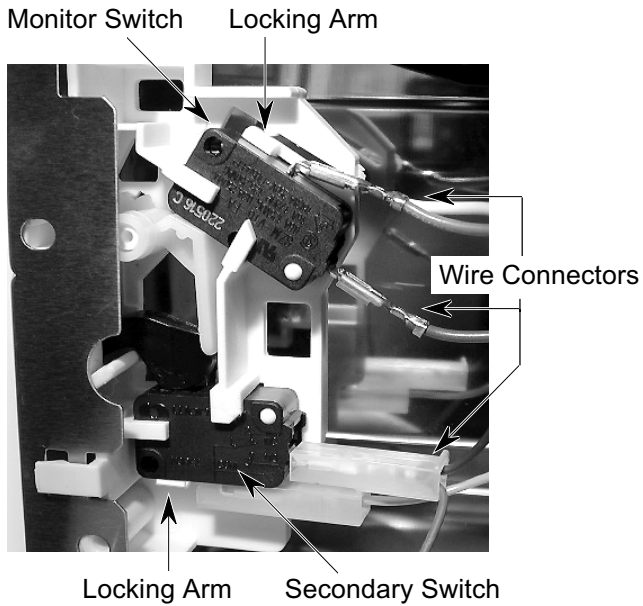

**CAUTION:** When you press in on the locking arm to remove the switch in the next step, be careful not to press in too far, or you will break the arm off. If this happens, you will have to replace the entire switch bracket.

- b) Press in on the locking arm, (refer to the previous photo), rotate the switch so it is free of the arm, and pull the switch off the pivot pin.

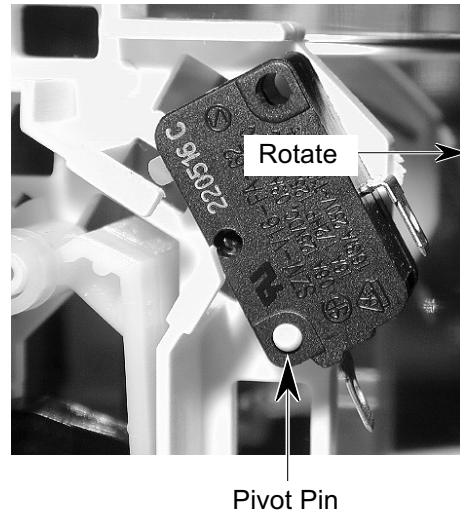

## REMOVING THE HUMIDITY SENSOR

### **! WARNING**

#### **Electrical Shock Hazard**

Disconnect power before servicing.  
Replace all panels before operating.  
Failure to do so could result in death or electrical shock.

**CAUTION:** When you work on the microwave oven, be careful when handling the sheet metal parts. Sharp edges may be present, and you can cut yourself if you are not careful.

1. Disconnect the electrical power to the microwave oven.
2. Remove the cabinet from the microwave oven (see page 2-2 for the procedure).
3. Remove the 2 screws from the top cover.

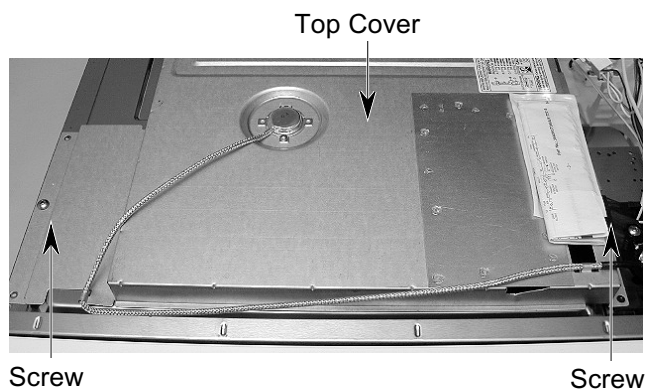

4. Remove the mounting screw from the humidity sensor, lift the sensor and slide the tab out of the slot in the top cover, and remove the sensor.

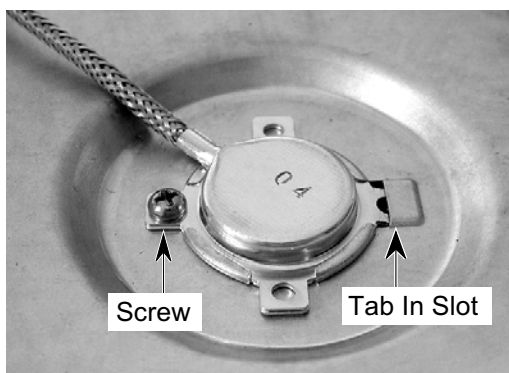

5. Lift the front of the top cover and bend the two clips out just enough to remove the humidity sensor cable from them.

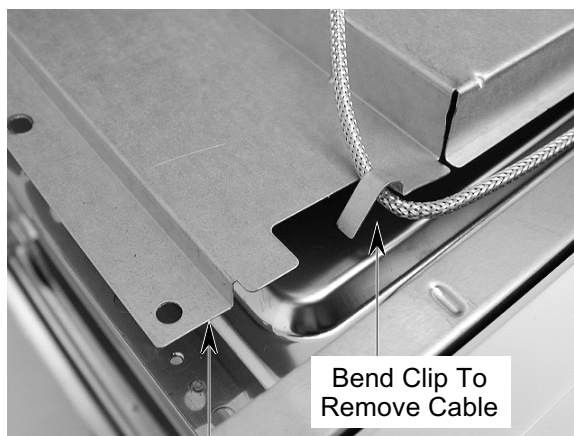

Lift Top Cover

6. Disconnect humidity sensor connector CN4 from the electronic oven control board.

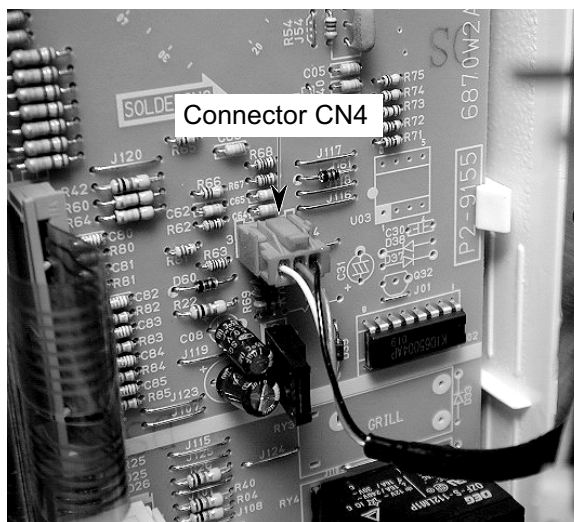

# REMOVING THE OVEN LAMP, THE DAMPER MOTOR, & DAMPER SWITCH

## **! WARNING**

### **Electrical Shock Hazard**

Disconnect power before servicing.  
Replace all panels before operating.  
Failure to do so could result in death or electrical shock.

**CAUTION:** When you work on the microwave oven, be careful when handling the sheet metal parts. Sharp edges may be present, and you can cut yourself if you are not careful.

1. Disconnect the electrical power to the microwave oven.
2. Remove the cabinet from the microwave oven (see page 2-2 for the procedure).
3. **To remove the oven lamp:**
  - a) Disconnect the wire connector from the lamp terminals.
  - b) Remove the mounting screw from the base.

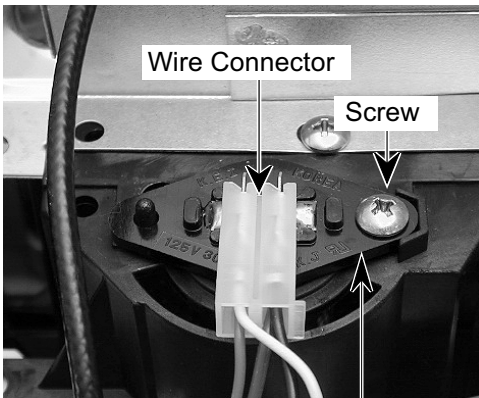

Oven Lamp Base

- c) Pull the oven lamp out of the unit.

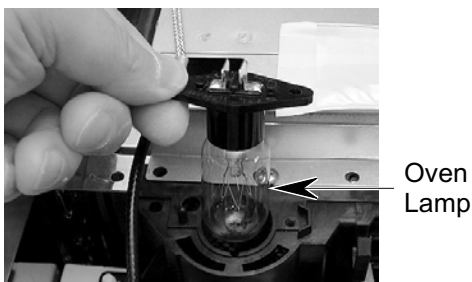

4. **To remove the damper motor:**
  - a) Disconnect the wire connector from the motor terminals.
  - b) Remove the two mounting screws.

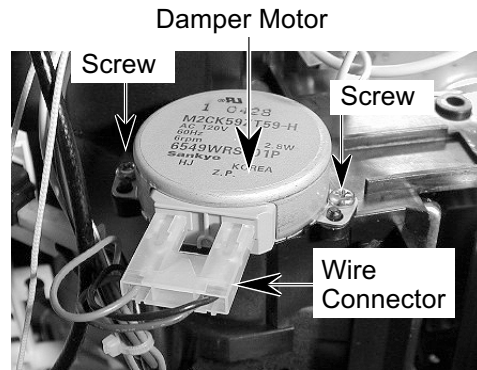

**REASSEMBLY NOTE:** When you reinstall the damper motor, align the flat of the motor shaft with the flat of the air damper hole, and insert the shaft into the hole.

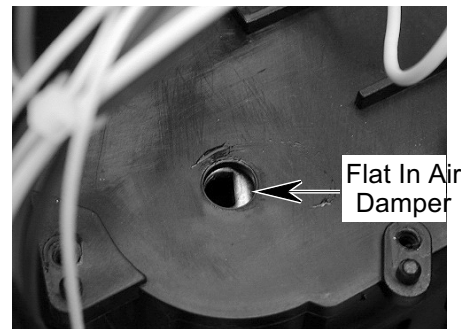

5. **To remove the damper switch:**
  - a) Disconnect the wire connector from the switch terminals.
  - b) Remove the mounting screw.

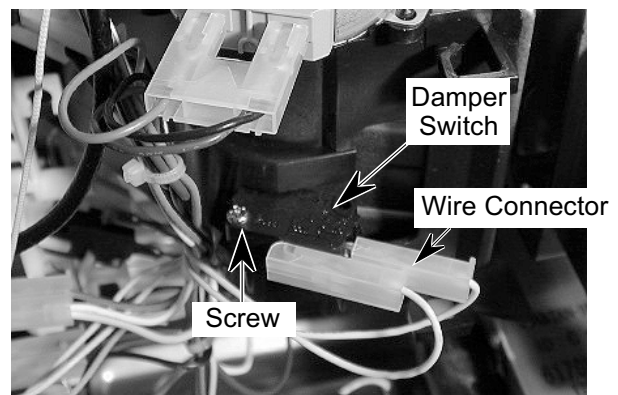

## REMOVING THE OVEN THERMOSTAT

### **! WARNING**

#### **Electrical Shock Hazard**

Disconnect power before servicing.  
Replace all panels before operating.  
Failure to do so could result in death or electrical shock.

**CAUTION:** When you work on the microwave oven, be careful when handling the sheet metal parts. Sharp edges may be present, and you can cut yourself if you are not careful.

1. Disconnect the electrical power to the microwave oven.
2. Remove the cabinet from the microwave oven (see page 2-2 for the procedure).

3. Disconnect the wire connectors from the oven thermostat terminals.

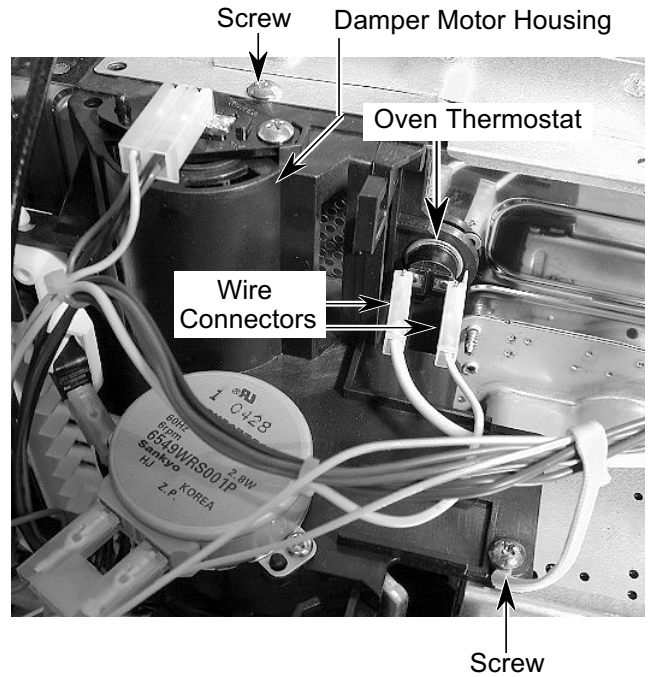

4. Remove the two indicated screws from the damper motor housing.
5. Pull the damper motor housing out and remove the oven thermostat.

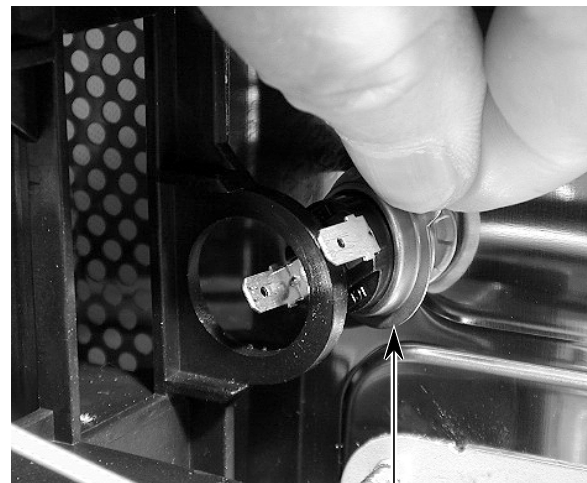

Oven Thermostat

## REMOVING THE MAGNETRON

### **! WARNING**

#### **Electrical Shock Hazard**

Disconnect power before servicing.  
Replace all panels before operating.  
Failure to do so could result in death or electrical shock.

**CAUTION:** When you work on the microwave oven, be careful when handling the sheet metal parts. Sharp edges may be present, and you can cut yourself if you are not careful.

1. Disconnect the electrical power to the microwave oven.
2. Remove the cabinet from the microwave oven (see page 2-2 for the procedure).

**CAUTION:** Discharge the high voltage capacitor terminals with a 20,000 ohm resistor to chassis ground.

3. Disconnect the filament connector from the magnetron terminals.
4. Remove the wire strap screw and the four magnetron mounting screws and remove the magnetron from the waveguide.

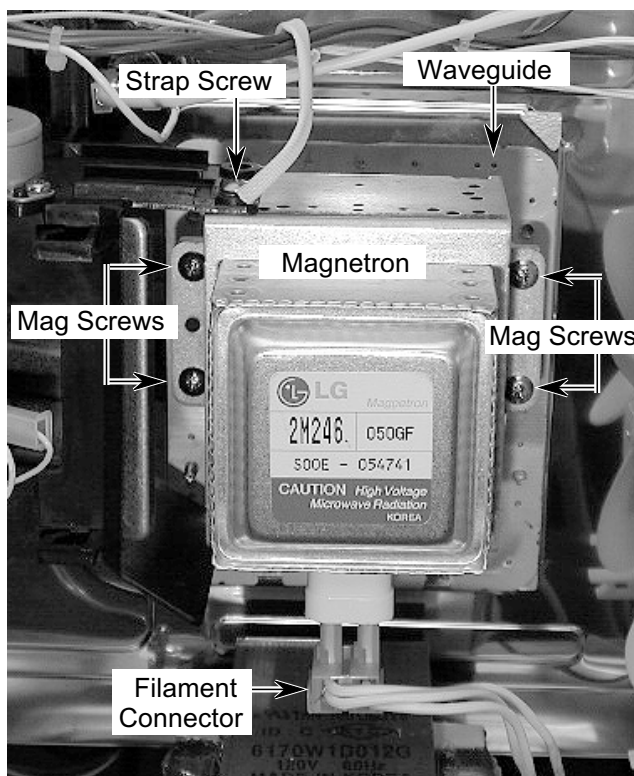

# REMOVING THE HIGH VOLTAGE TRANSFORMER

## **! WARNING**

### **Electrical Shock Hazard**

Disconnect power before servicing.  
Replace all panels before operating.  
Failure to do so could result in death or electrical shock.

**CAUTION:** When you work on the microwave oven, be careful when handling the sheet metal parts. Sharp edges may be present, and you can cut yourself if you are not careful.

1. Disconnect the electrical power to the microwave oven.
2. Remove the cabinet from the microwave oven (see page 2-2 for the procedure).

**CAUTION:** Discharge the high voltage capacitor terminals with a 20,000 ohm resistor to chassis ground.

3. Disconnect the two primary wire connectors from the high voltage transformer terminals.
4. Disconnect the filament connector from the magnetron and the secondary winding connectors from the high voltage capacitor.

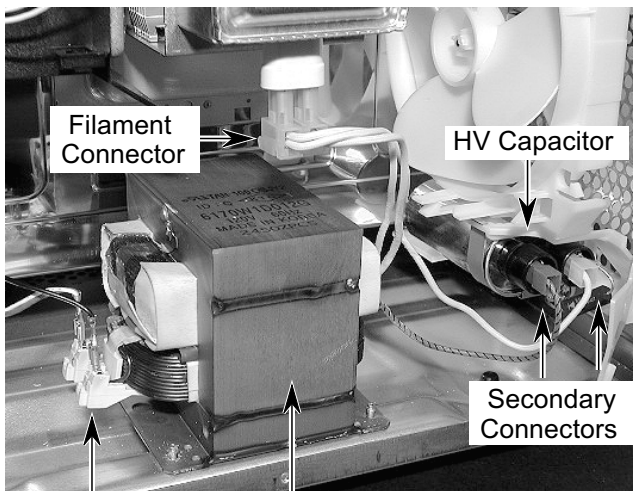

Primary Connectors      HV Transformer

5. Position the microwave oven on its left side so that the bottom of the oven is accessible.

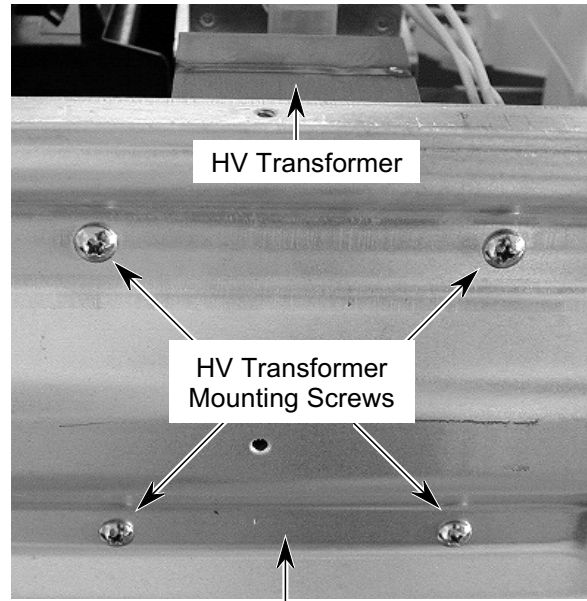

**Bottom Of Oven**

6. Remove the four high voltage transformer mounting screws from the bottom of the oven. Hold the transformer with one hand to keep it from falling.

## REMOVING THE LINE FUSE & FUSEHOLDER

### **! WARNING**

#### **Electrical Shock Hazard**

Disconnect power before servicing.  
Replace all panels before operating.  
Failure to do so could result in death or electrical shock.

**CAUTION:** When you work on the microwave oven, be careful when handling the sheet metal parts. Sharp edges may be present, and you can cut yourself if you are not careful.

1. Disconnect the electrical power to the microwave oven.
2. Remove the cabinet from the microwave oven (see page 2-2 for the procedure).

3. Disconnect the two wire connectors from the line fuse terminals.
4. Unsnap the 20A line fuse from the fuseholder.
5. Remove the screw from the fuseholder and remove it from the bracket.

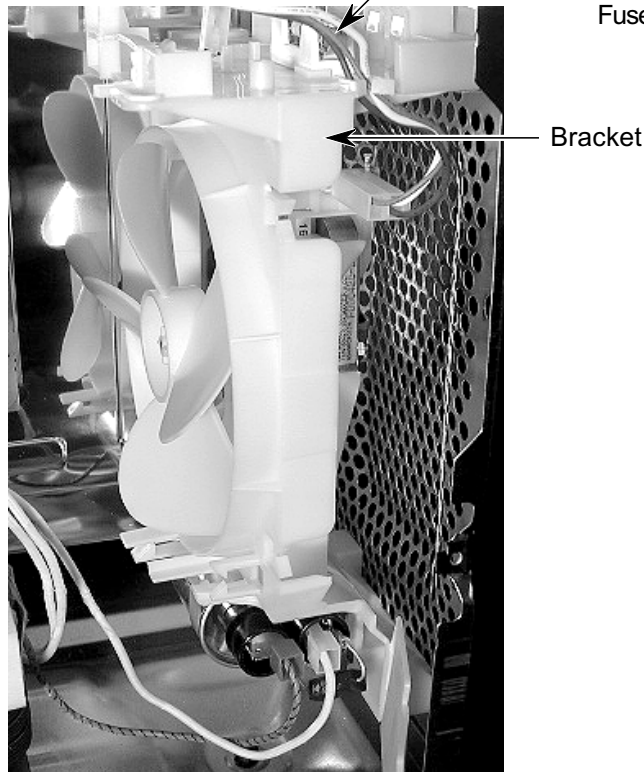
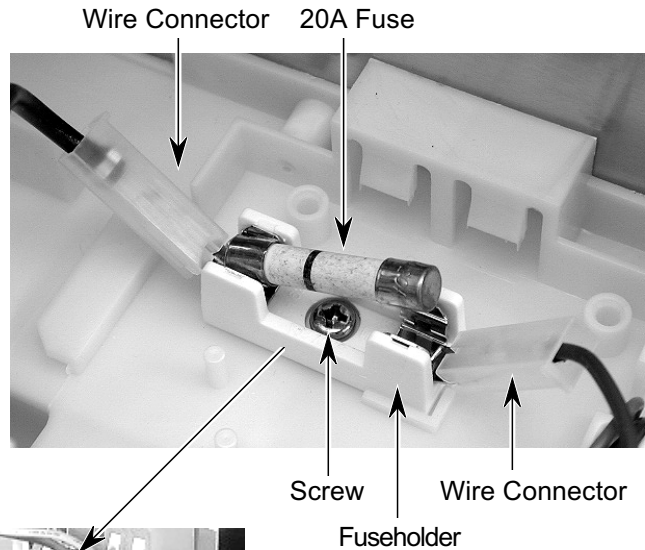



# REMOVING THE HIGH VOLTAGE RECTIFIER, THE HIGH VOLTAGE CAPACITOR, AND THE FAN MOTOR

## **! WARNING**

### **Electrical Shock Hazard**

Disconnect power before servicing.  
Replace all panels before operating.  
Failure to do so could result in death or electrical shock.

**CAUTION:** When you work on the microwave oven, be careful when handling the sheet metal parts. Sharp edges may be present, and you can cut yourself if you are not careful.

1. Disconnect the electrical power to the microwave oven.
2. Remove the cabinet from the microwave oven (see page 2-2 for the procedure).

**CAUTION: Discharge the high voltage capacitor terminals with a 20,000 ohm resistor to chassis ground.**

3. **To remove the high voltage rectifier:**
  - a) Open the cover on the mounting bracket.

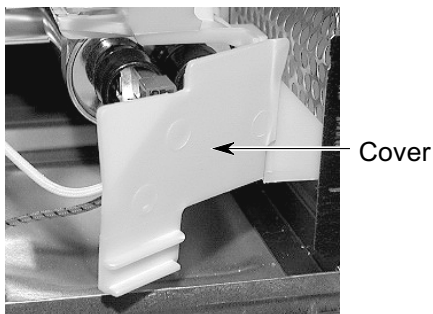

- b) Disconnect the high voltage rectifier lead from the high voltage capacitor terminal.

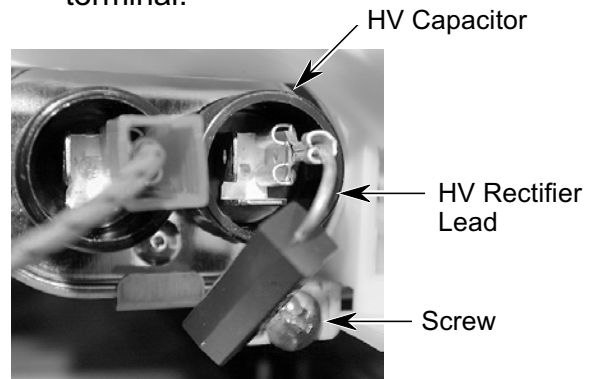

- c) Remove the mounting screw from the other lead of the high voltage rectifier.

**To remove the high voltage capacitor & fan motor, perform the following steps.**

4. Remove the two mounting bracket screws from the rear panel of the microwave oven.

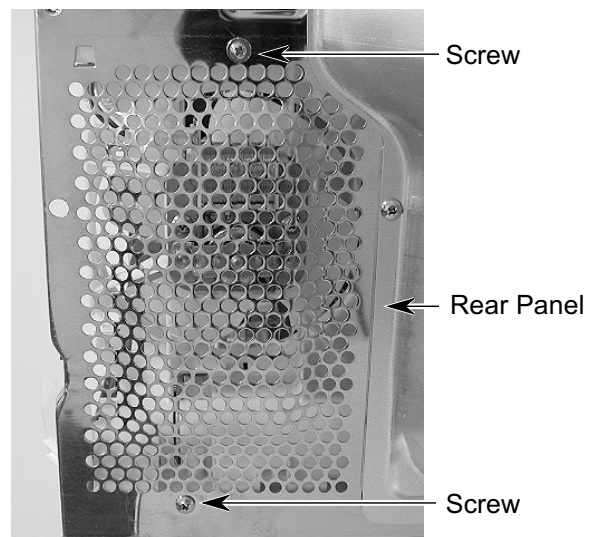

**Continued on the next page.**

5. Disconnect the wire connectors from the line fuse terminals, the fan motor, and the high voltage capacitor, and remove the bracket assembly.

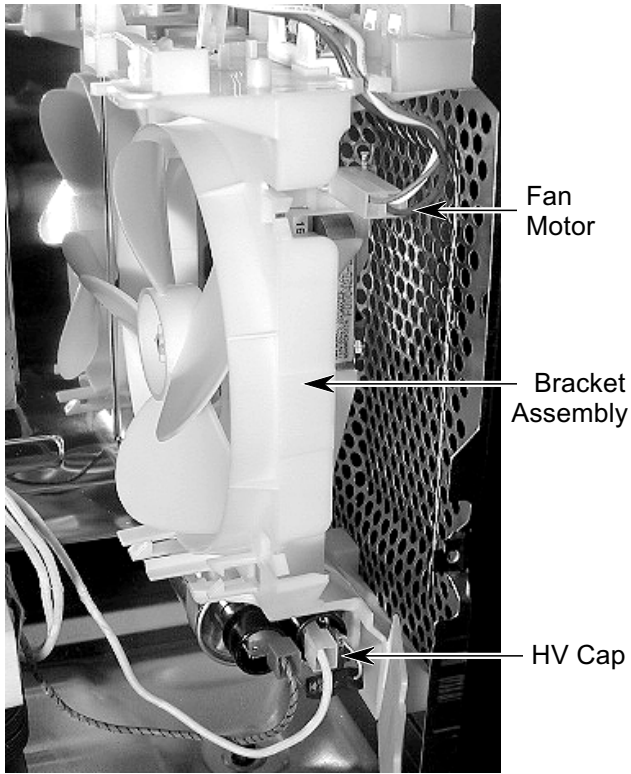

7. **To remove the fan motor:**
  - a) Pull the fan off the motor shaft.

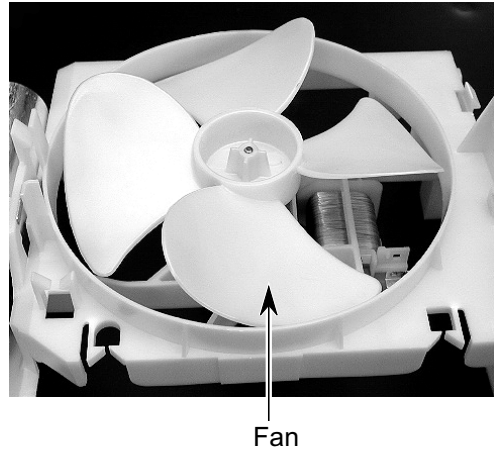

- b) Remove the two screws from the fan motor and remove the motor from the bracket.

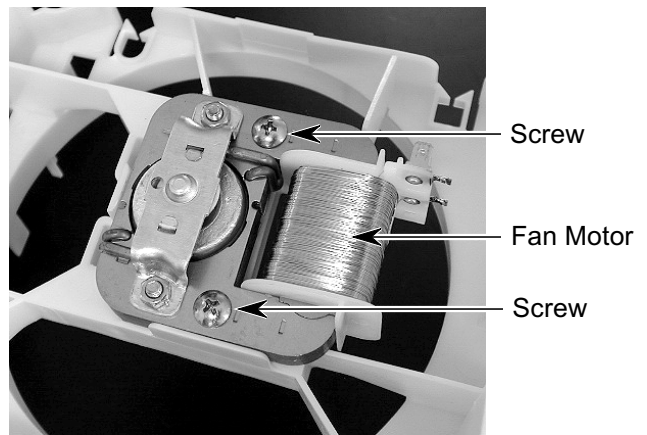

6. **To remove the high voltage capacitor:**
  - a) Disconnect the high voltage rectifier lead from the terminal of the high voltage capacitor.

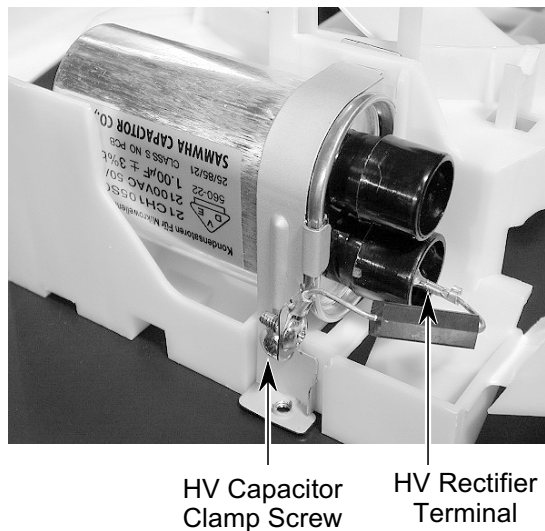

- b) Remove the clamp screw and remove the high voltage capacitor from the bracket.

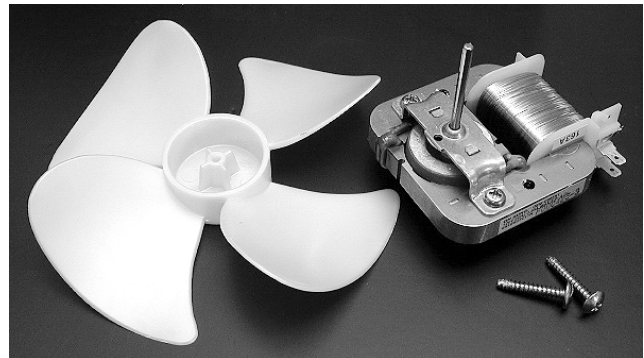

# REMOVING THE CONVECTION THERMISTOR, CIRCULATION MOTOR, & CONVECTION ELEMENT

## **! WARNING**

### **Electrical Shock Hazard**

Disconnect power before servicing.  
 Replace all panels before operating.  
 Failure to do so could result in death or electrical shock.

**CAUTION:** When you work on the microwave oven, be careful when handling the sheet metal parts. Sharp edges may be present, and you can cut yourself if you are not careful.

1. Disconnect the electrical power to the microwave oven.
2. Remove the cabinet from the microwave oven (see page 2-2 for the procedure).
3. **To remove the convection thermistor:**
  - a) Remove the four screws from the rear convection cover.
  - b) Pull the top cover tab out of the slot, lift the cover, pull the two lower tabs from their slots, and remove the cover.

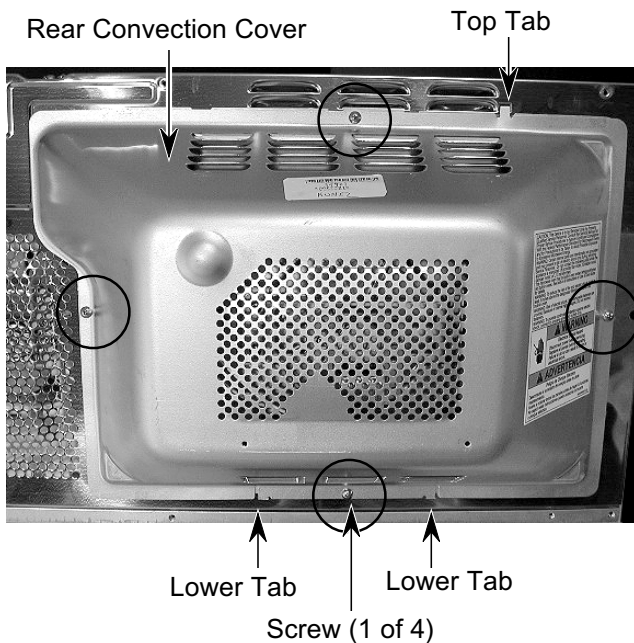

- c) Remove the thermistor mounting screw.

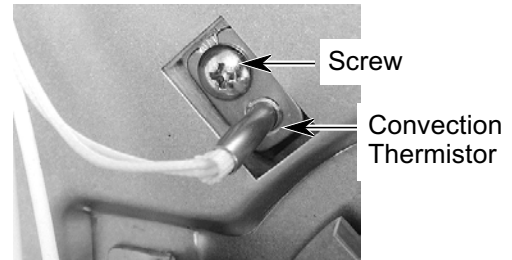

- d) Disconnect the wire connector at electronic oven control plug CN5.

Thermistor Connector CN5

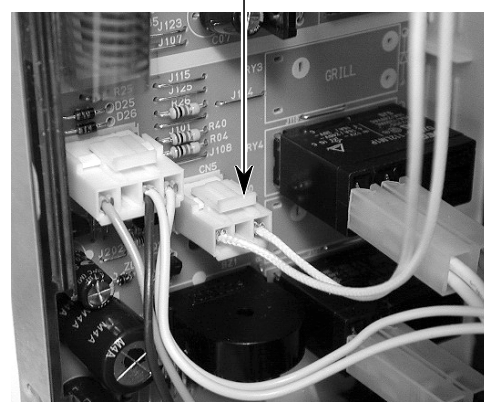

4. **To remove the circulation motor:**
  - a) If not already done, remove the rear convection cover (see steps 3a & 3b).
  - b) Remove the four 7 mm hex-washer nuts from the convection mounting cover, remove the cover from the studs, and lean it against the rear of the unit.

7 mm Nut (1 of 4) Convection Thermistor

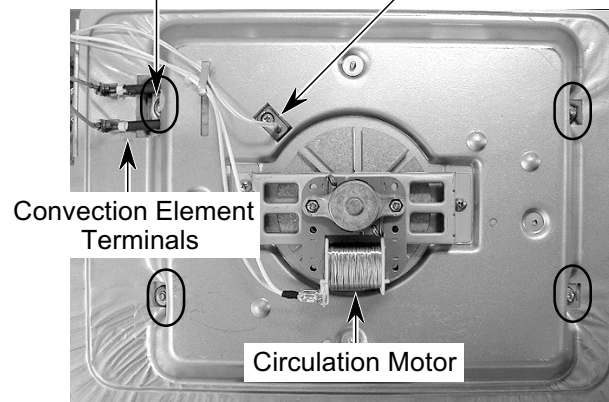

Continued on the next page.

- c) Remove the two wire connectors from the circulation motor terminals.

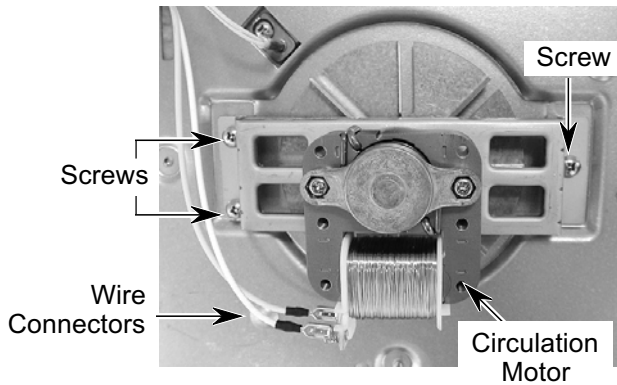

- d) Remove the three circulation fan motor mounting bracket screws and remove the motor and bracket.

- e) Remove the 7 mm nut, split washer, flat washer, and outer fan from the circulation motor shaft.

7 mm Nut On Outer Fan

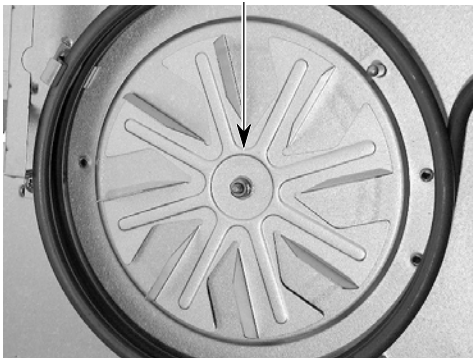

- f) Remove the spacer and inner fan from the circulation motor shaft.

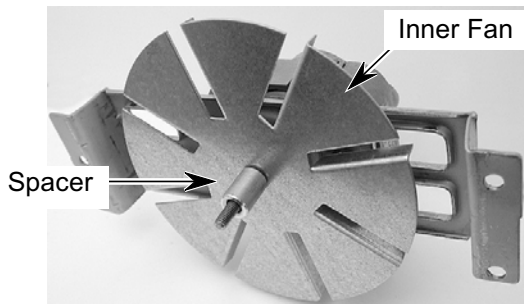

- g) Remove the two 7 mm nuts and remove the circulation motor from the bracket.

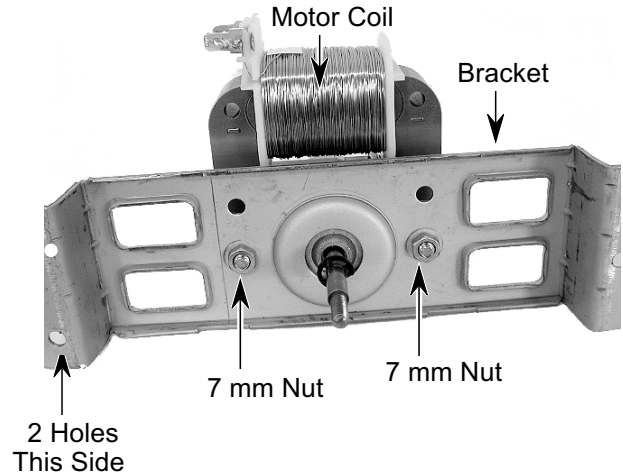

**REASSEMBLY NOTE:** Make sure that you mount the circulation motor on the bracket with the two bracket holes to the left and the motor coil positioned up, as shown above.

**5. To remove the convection element:**

- a) If not already done, remove the rear convection cover (see steps 3a & 3b on page 2-15).
- b) Remove the two screws and split washers from the ends of the element and remove the two wire connectors.

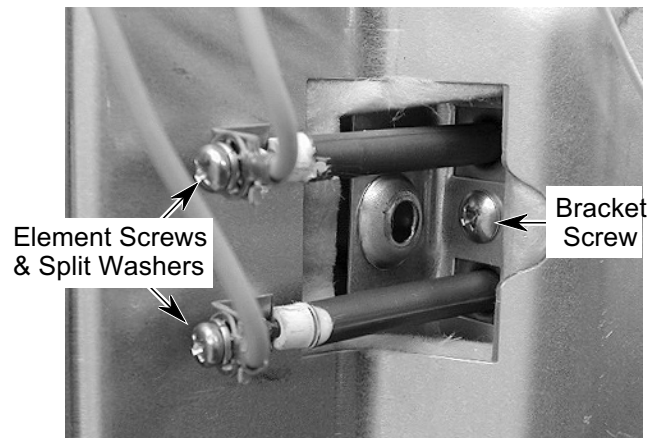

- c) Remove the mounting screw from the element bracket.
- d) If not already done, remove the convection mounting cover from the back of the unit (see step 4b on page 2-15).

- e) Remove the two mounting screws from the convection element brackets and remove the element.

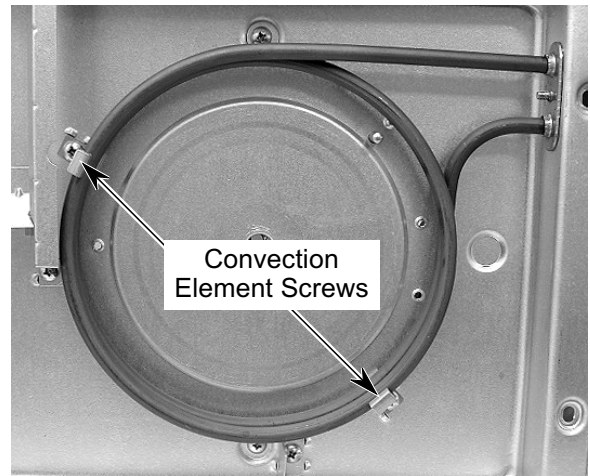

# REMOVING THE TURNTABLE MOTOR

## ⚠️ WARNING

### Electrical Shock Hazard

Disconnect power before servicing.  
 Replace all panels before operating.  
 Failure to do so could result in death or electrical shock.

**CAUTION:** When you work on the microwave oven, be careful when handling the sheet metal parts. Sharp edges may be present, and you can cut yourself if you are not careful.

1. Disconnect the electrical power to the microwave oven.
2. Remove the cabinet from the microwave oven (see page 2-2 for the procedure).
3. Open the microwave oven door and lift the turntable spindle off the turntable motor shaft.

Turntable Spindle

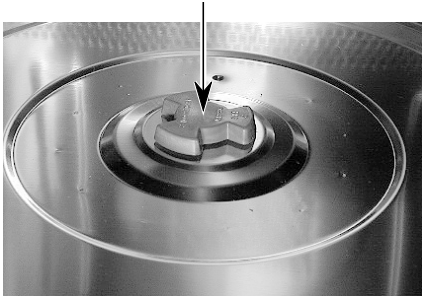

4. Turn the microwave oven on its left side.

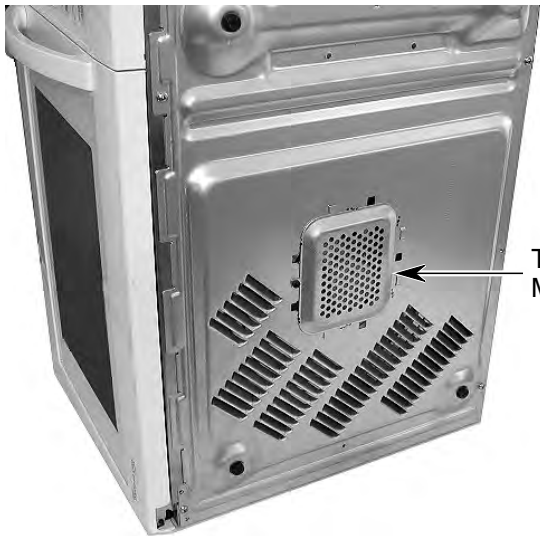

Turntable Motor Cover

5. Use a pair of wire cutters and clip the six areas between the holes on the turntable motor cover, and remove the cover.

Cut Here (1 of 6 Places)

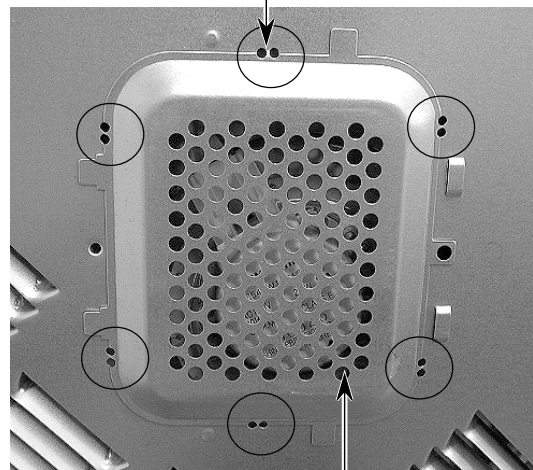

Turntable Motor Cover

6. Remove the wire connector from the turntable motor terminals, and then remove the two screws.

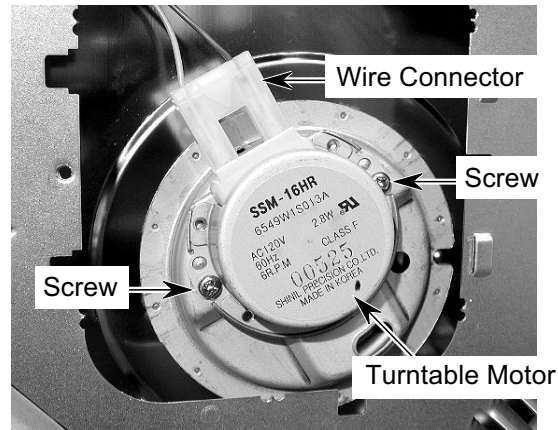

Wire Connector

Screw

Screw

Turntable Motor

**REASSEMBLY NOTE:** To install the cover over the turntable motor, insert the two tabs into the slots and use a #6 screw to secure it.

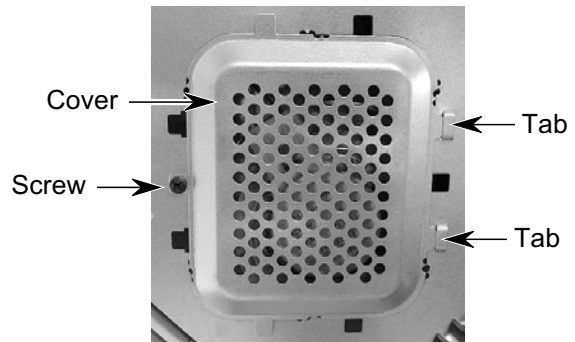

Cover

Screw

Tab

Tab

# REMOVING THE OVEN DOOR, THE SWITCH ACTUATORS, AND THE OUTER GLASS

## **! WARNING**

### **Electrical Shock Hazard**

Disconnect power before servicing.  
Replace all panels before operating.  
Failure to do so could result in death or electrical shock.

**CAUTION:** When you work on the microwave oven, be careful when handling the sheet metal parts. Sharp edges may be present, and you can cut yourself if you are not careful.

1. Disconnect the electrical power to the microwave oven.
2. Open the microwave oven door and remove the choke cover. To do this:
  - a) Use a small screwdriver and pry out on the indicated corner of the choke cover until the bottom locking tab pops out.

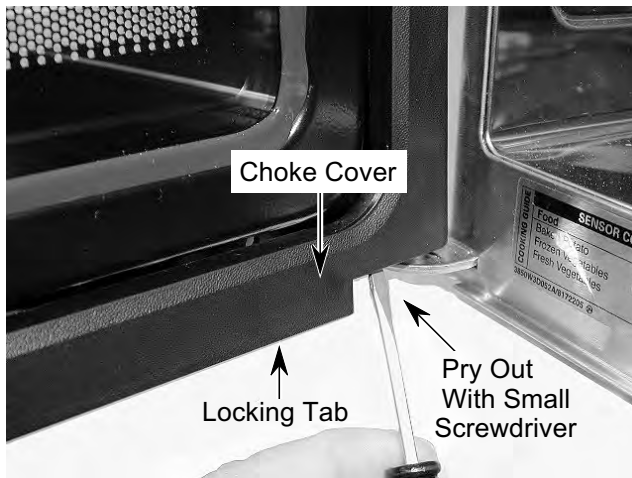

- b) Use a putty knife and pry out along the inner edge of the choke cover.
- c) Pull out on the cover to release all of the locking tabs, and remove the cover from the door.

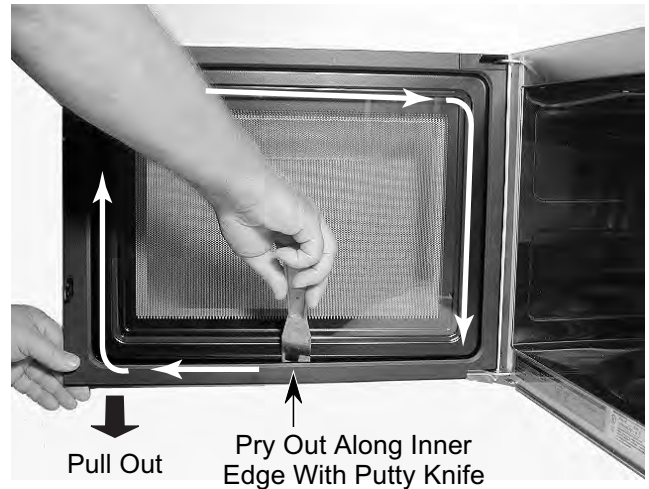

### 3. To remove the oven door:

- a) Lift the door and remove the bottom hinge pin from its bracket hole, then lower the door and remove the top hinge pin from its bracket hole.



- b) Place the door on a padded surface with the handle and outer glass facing down.

**Continued on the next page.**

4. To remove the switch actuators:

a) Remove the two inner door frame screws.

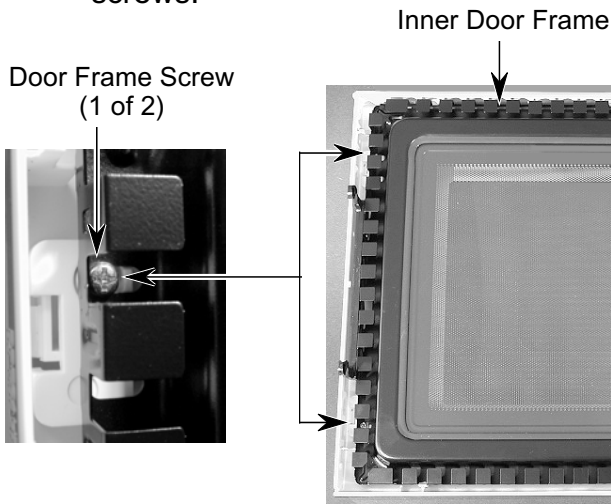

b) Start at the lower right corner of the door and unclip the locking tabs along the bottom and right sides of the inner door frame while you lift the frame.

c) When the inner door frame is free of the tabs, slide the frame out of the 3 top holders and remove it.

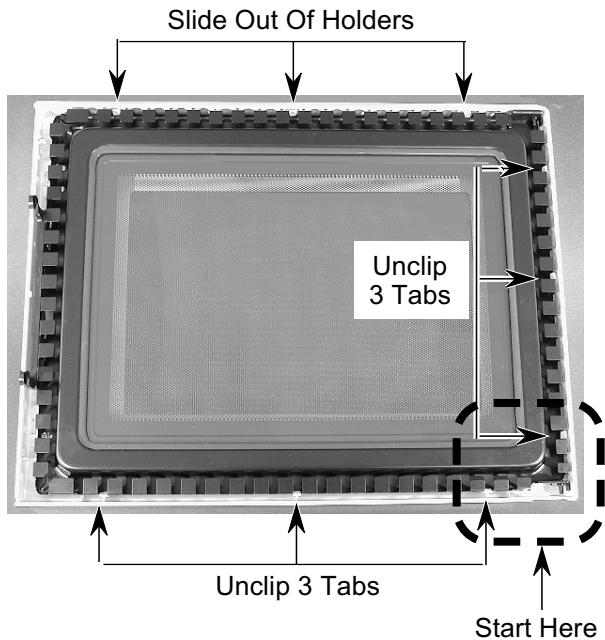

d) Remove the end of the spring from the actuators.

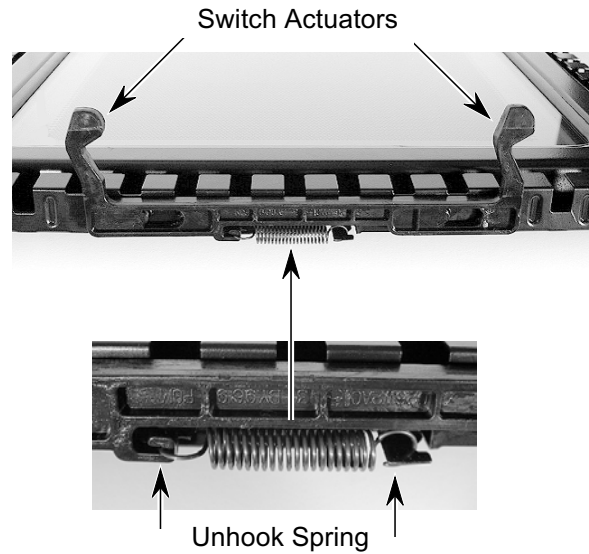

e) Unhook the actuators from the slots in the inner door frame.

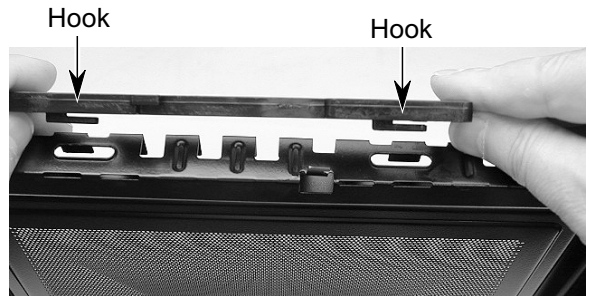



**5 To remove the outer glass:**

- a) Use a screwdriver and push the 10 locking tabs (see the arrows below) back so they are not over the glass.

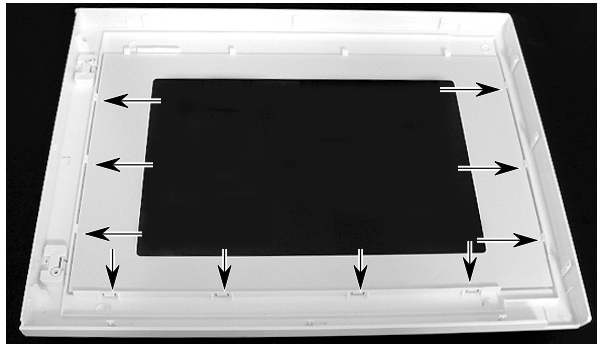

Outer Glass →

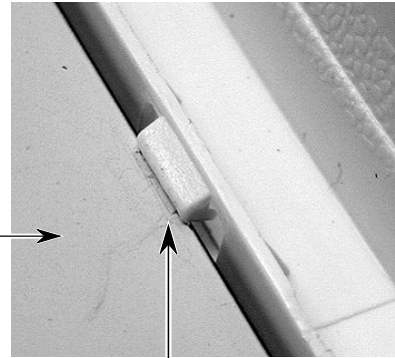

Tab Over Outer Glass

- b) Lift the glass and remove it from the door frame.

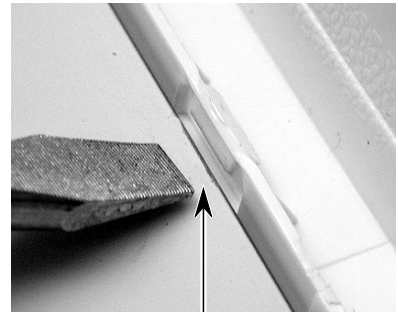

Tab Pushed Back

— NOTES —

# COMPONENT TESTING

Before testing any of the components, perform the following checks:

- The most common cause for control failure is corrosion on connectors. Therefore, disconnecting and reconnecting wires will be necessary throughout test procedures.
- All tests/checks should be made with a VOM or DVM having a sensitivity of 20,000 ohms-per-volt DC, or greater.
- Check all connections before replacing components, looking for broken or loose wires, failed terminals, or wires not pressed into connectors far enough.
- Any voltage checks must be made with all connectors attached to the boards.
- Resistance checks must be made with power cord unplugged from outlet, and with wiring harness or connectors disconnected.

## THE TURNTABLE AND DAMPER MOTORS

### **! WARNING**

#### **Electrical Shock Hazard**

Disconnect power before servicing.  
Replace all panels before operating.  
Failure to do so could result in death or electrical shock.

### **! WARNING**

#### **Electrical Shock Hazard**

Disconnect power before servicing.  
Replace all panels before operating.  
Failure to do so could result in death or electrical shock.

### TURNTABLE MOTOR

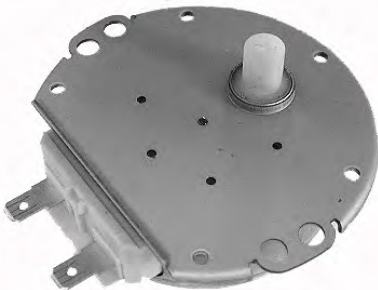

Refer to page 2-18 for the procedure for servicing the turntable motor.

1. Disconnect the electrical power to the microwave oven.
2. Disconnect the wires from the turntable motor terminals.
3. Set the ohmmeter to the R x 1 scale.
4. Touch the ohmmeter leads to the motor terminals. The meter should indicate 25  $\Omega$ .

### DAMPER MOTOR



Refer to page 2-8 for the procedure for servicing the damper motor.

1. Disconnect the electrical power to the microwave oven.
2. Disconnect the wires from the damper motor terminals.
3. Set the ohmmeter to the R x 1K scale.
4. Touch the ohmmeter leads to the motor terminals. The meter should indicate between 2900 and 3400  $\Omega$ .

## THE FAN AND CIRCULATION MOTORS

### **! WARNING**

#### **Electrical Shock Hazard**

Disconnect power before servicing.  
Replace all panels before operating.  
Failure to do so could result in death or electrical shock.

### **! WARNING**

#### **Electrical Shock Hazard**

Disconnect power before servicing.  
Replace all panels before operating.  
Failure to do so could result in death or electrical shock.

### FAN MOTOR



Refer to page 2-13 for the procedure for servicing the fan motor.

1. Disconnect the electrical power to the microwave oven.
2. Disconnect the wires from the fan motor terminals.
3. Set the ohmmeter to the R x 1 scale.
4. Touch the ohmmeter leads to the motor terminals. The meter should indicate approximately 50  $\Omega$ .

### CIRCULATION MOTOR



Refer to page 2-15 for the procedure for servicing the circulation motor.

1. Disconnect the electrical power to the microwave oven.
2. Disconnect the wires from the circulation motor terminals.
3. Set the ohmmeter to the R x 1 scale.
4. Touch the ohmmeter leads to the motor terminals. The meter should indicate approximately 30  $\Omega$ .

# THE LINE FUSE, HIGH VOLTAGE RECTIFIER (DIODE), & HIGH VOLTAGE CAPACITOR

Refer to page 2-12 for the procedure for servicing the line fuse, and page 2-13 for the high voltage rectifier (diode) and high voltage capacitor.

1. Disconnect the electrical power to the microwave oven.

## Line Fuse W/Fuseholder

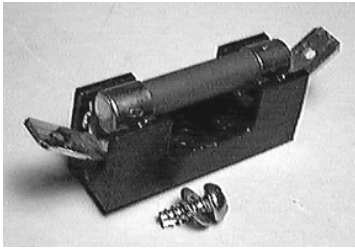

2. **To test the line fuse:**

- a) Unclip the fuse from the fuseholder.
- b) Set the ohmmeter to the R x 1 scale.
- c) Touch the ohmmeter leads to the ends of the fuse. The meter should indicate continuity if the fuse is good. If the fuse is open, the meter will indicate infinity.

## High Voltage Rectifier (Diode)

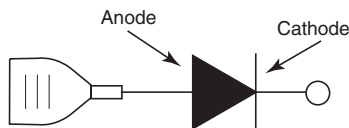
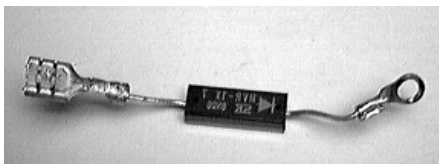

3. **To test the high voltage rectifier:**

- a) Disconnect the diode lead from the high voltage capacitor.

- b) Set the ohmmeter to the R x 10K scale.
- c) Touch the positive ohmmeter lead to the anode lead of the diode and the negative lead to the cathode. The meter should indicate continuity.

Reverse the ohmmeter leads on the diode and the meter should indicate infinity.

## High Voltage Capacitor



4. **To test the high voltage capacitor:**

- a) Disconnect the diode and wires from the high voltage capacitor terminals.
- b) Set the ohmmeter to the R x 10K scale.
- c) Touch the ohmmeter leads to the capacitor terminals. The meter should indicate several thousand ohms, and gradually return to infinity.

# THE CONVECTION ELEMENT & HUMIDITY SENSOR

## **! WARNING**

### **Electrical Shock Hazard**

Disconnect power before servicing.  
Replace all panels before operating.  
Failure to do so could result in death or electrical shock.

### **CONVECTION ELEMENT**



Refer to page 2-15 for the procedure for servicing the convection element.

1. Disconnect the electrical power to the microwave oven.
2. Disconnect the wires from one of the element terminals.
3. Set the ohmmeter to the R x 1K scale.
4. Touch the ohmmeter leads to the terminals. The meter should indicate approximately 10  $\Omega$ .

## **! WARNING**

### **Electrical Shock Hazard**

Disconnect power before servicing.  
Replace all panels before operating.  
Failure to do so could result in death or electrical shock.

### **HUMIDITY SENSOR**



Refer to page 2-7 for the procedure for servicing the humidity sensor.

1. Disconnect the electrical power to the microwave oven.
2. Disconnect the humidity sensor connector from the electronic oven control at CN4.
3. Set the ohmmeter to the R x 1K scale.
4. Touch the ohmmeter leads to the following wires at the connector pin slots:  
Black to red = 6200  $\Omega$   
Black to white = 3000  $\Omega$   
Red to white = 3000  $\Omega$

# THE CONVECTION THERMISTOR & OVEN THERMOSTAT

## **! WARNING**

### **Electrical Shock Hazard**

Disconnect power before servicing.  
Replace all panels before operating.  
Failure to do so could result in death or electrical shock.

## **CONVECTION THERMISTOR**

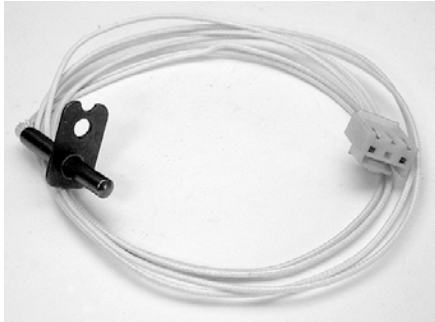

Refer to page 2-15 for the procedure for servicing the convection thermistor.

1. Disconnect the electrical power to the microwave oven.
2. Disconnect the convection thermistor connector from the electronic oven control at CN5.
3. Set the ohmmeter to the R x 10K scale.
4. Touch the ohmmeter leads to connector pin slots 1 and 3. The meter should indicate approximately 210 K $\Omega$ .

## **! WARNING**

### **Electrical Shock Hazard**

Disconnect power before servicing.  
Replace all panels before operating.  
Failure to do so could result in death or electrical shock.

## **OVEN THERMOSTAT**



Refer to page 2-9 for the procedure for servicing the oven thermostat.

1. Disconnect the electrical power to the microwave oven.
2. Disconnect the wires from the oven thermostat terminals.
3. Set the ohmmeter to the R x 1 scale.
4. Touch the ohmmeter leads to the thermostat terminals. At room temperature, the meter should indicate continuity (closed contacts).

# THE MAGNETRON & HIGH VOLTAGE TRANSFORMER

## ! WARNING

### Electrical Shock Hazard

Disconnect power before servicing.  
Replace all panels before operating.  
Failure to do so could result in death or electrical shock.

## MAGNETRON

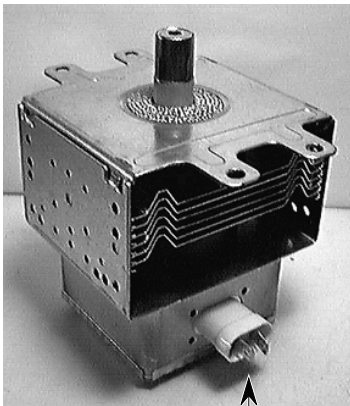

Filament Terminals

Refer to page 2-10 for the procedure for servicing the magnetron.

1. Disconnect the electrical power to the microwave oven.
2. Disconnect the wires from the filament terminals.
3. Set the ohmmeter to the R x 1 scale.
4. Touch the ohmmeter leads to the filament terminals. The meter should indicate less than 1  $\Omega$ .
5. Set the ohmmeter to the R x 100 scale.
6. Touch one of the ohmmeter leads to the chassis and the other lead to the filament terminals. The meter should indicate infinity (no continuity).

## ! WARNING

### Electrical Shock Hazard

Disconnect power before servicing.  
Replace all panels before operating.  
Failure to do so could result in death or electrical shock.

## HIGH VOLTAGE TRANSFORMER

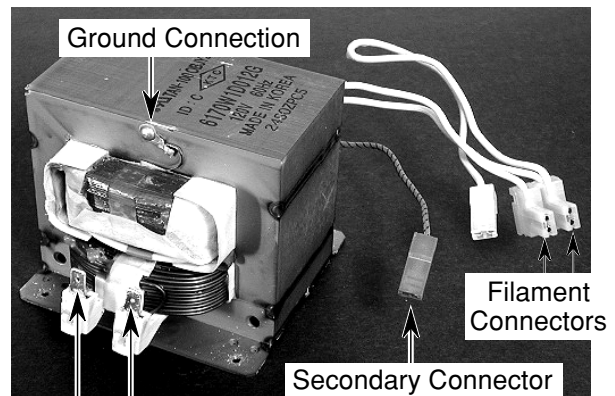

Primary Terminals

Refer to page 2-11 for the procedure for servicing the high voltage transformer.

1. Disconnect the electrical power to the microwave oven.
2. Disconnect the high voltage transformer secondary and filament wire connectors from the high voltage capacitor and magnetron.
3. Disconnect the two wires from the primary terminals.
4. Set the ohmmeter to the R x 1 scale.
5. Touch the ohmmeter leads to the two primary terminals. The meter should indicate between .3 and .6  $\Omega$ .
6. Touch the ohmmeter leads to the two filament wire connectors. The meter should indicate less than 1  $\Omega$ .
7. Touch one ohmmeter lead to the red with a black stripe secondary wire, and the other lead to the ground connection on the transformer. The meter should indicate 0  $\Omega$  (short circuit).



## THE DAMPER & DOOR INTERLOCK SWITCHES

# ! WARNING

### Electrical Shock Hazard

Disconnect power before servicing.  
 Replace all panels before operating.  
 Failure to do so could result in death or electrical shock.

### DAMPER & DOOR INTERLOCK SWITCHES



Refer to page 2-8 for the procedure for servicing the damper switch and page 2-5 for the door interlock switches.

1. Disconnect the electrical power to the microwave oven.
2. Set the ohmmeter to the R x 1 scale.
3. **To test the damper switch:**
  - a) Disconnect the wires from the damper switch terminals.
  - b) Touch the ohmmeter leads to the two terminals. The meter should indicate infinity (no continuity).
  - c) Touch the ohmmeter leads to the switch terminals and press the switch actuator. The meter should indicate 0 Ω (continuity).

4. Use the following tests to check the desired door interlock switch:

- a) **Primary switch:** Disconnect the wire connector from the terminals.
  - b) With the door closed, touch the ohmmeter leads to the switch terminals. The meter should indicate 0 Ω (continuity).
  - c) With the door open, touch the ohmmeter leads to the switch terminals. The meter should indicate infinity (no continuity).
- a) **Monitor switch:** Disconnect the wires from the terminals.
  - b) With the door closed, touch the ohmmeter leads to the switch terminals. The meter should indicate infinity (no continuity).
  - c) With the door open, touch the ohmmeter leads to the switch terminals. The meter should indicate 0 Ω (continuity).
- a) **Secondary switch:** Disconnect the wire connector from the terminals.
  - b) With the door closed, touch the ohmmeter leads to the switch terminals. The meter should indicate 0 Ω (continuity).
  - c) With the door open, touch the ohmmeter leads to the switch terminals. The meter should indicate infinity (no continuity).

Door Switch	Door Closed	Door Open
Primary	Continuity	No Continuity
Monitor	No Continuity	Continuity
Secondary	Continuity	No Continuity

— NOTES —

# DIAGNOSIS & TROUBLESHOOTING

## TOUCH PANEL CONTINUITY TEST

1. Remove the electronic oven control from the microwave oven (see page 2-3 for the procedure).
2. Set the ohmmeter to the R x 1 scale.
3. Refer to the "Touch Panel Continuity Diagram," and touch the ohmmeter leads to the indicated conducting paths on the "Flex Circuit Connector Diagram." Press the keypad indicated in the chart for the circuit under test. The meter should indicate continuity if the switch is working properly.

Touch Panel Continuity Diagram

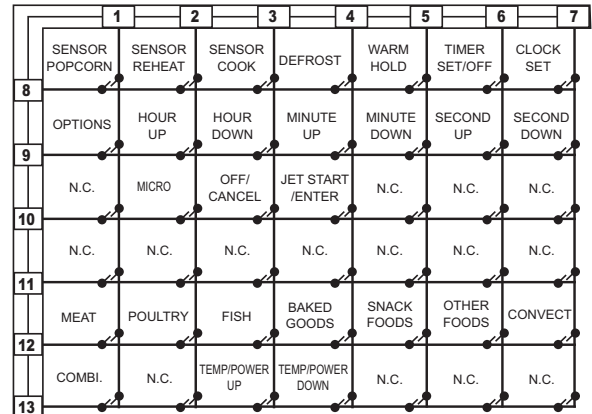

Electronic Oven Control Board Layout

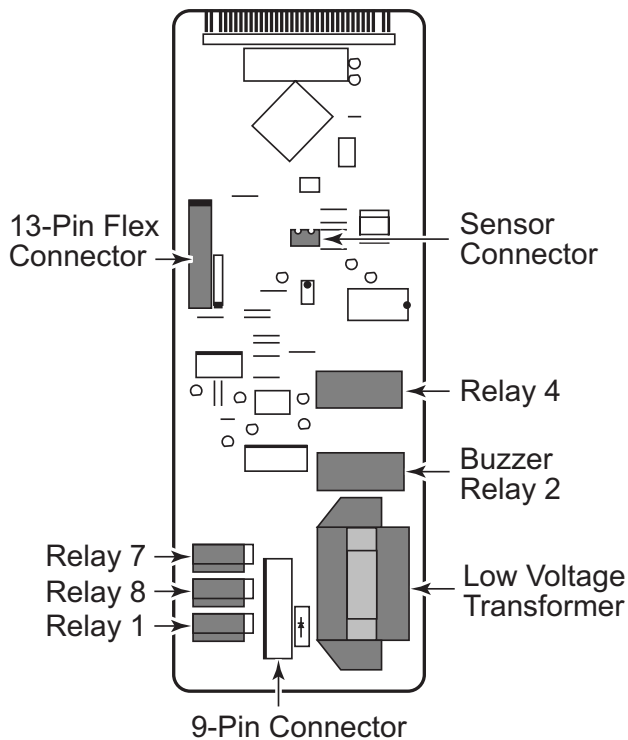

Flex Circuit Connector Diagram

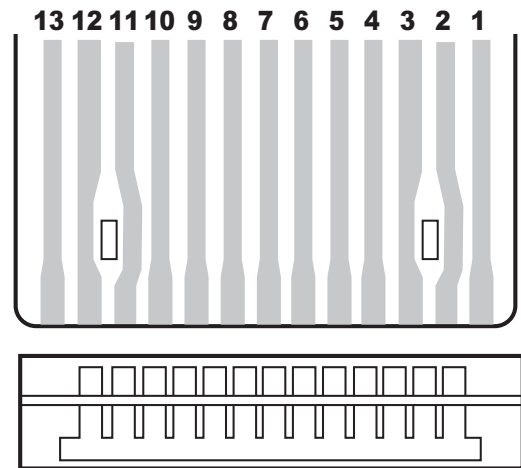

## MICROWAVE OVEN POWER OUTPUT TEST

The power output of the magnetron can be measured by the following test: (for accurate results, the line voltage must be 120 VAC and the oven cavity must be clean).

1. Fill a glass measuring cup with one cup (250 ml) of "lukewarm" (68°F / 20°C) to (77°F / 25°C) tap water.

2. Place the cup of water in the center of the oven.
3. Operate the microwave oven at HIGH power.
4. The water should boil within 3-1/2 to 4 minutes.

NOTE: Times longer than 4 minutes may indicate that the operating voltage is lower than 110 volts, or that there is a problem with the oven.

## TROUBLESHOOTING CHART

PROBLEM	CAUSE
<p><b>The microwave oven will not run.</b></p>	<ul style="list-style-type: none"> <li>• The door is not firmly closed and latched.</li> <li>• The START keypad was not touched.</li> <li>• The directions were not exactly performed.</li> <li>• An earlier programmed operation is still running.</li> <li>• The time was not set after touching the MICRO keypad.</li> </ul>
<p><b>Microwave cooking times seem too long.</b></p>	<ul style="list-style-type: none"> <li>• The electrical supply to the wall outlets is low, or is lower than normal. Check to find out if the line voltage is low.</li> <li>• The COOK POWER is not at the recommended setting.</li> <li>• Larger amounts of food need longer cooking times.</li> </ul>
<p><b>The turntable will not turn.</b></p>	<ul style="list-style-type: none"> <li>• The turntable is not correctly in place. Make sure that the turntable has the correct-side facing up and is sitting securely on center spindle.</li> <li>• The support is not operating correctly. Remove the turntable, check that the turntable spindle is properly in place, and restart the oven.</li> </ul>
<p><b>The display shows a time counting down, but the oven is not cooking.</b></p>	<ul style="list-style-type: none"> <li>• The oven door is not closed completely.</li> <li>• The control is set as a kitchen timer. Touch TIMER SET/OFF to cancel the Minute Timer.</li> </ul>
<p><b>The programming tone cannot be heard.</b></p>	<ul style="list-style-type: none"> <li>• The tones have been disabled. Refer to the “Use and Care Guide” for the procedure on setting the tones.</li> </ul>
<p><b>The fan seems to be running slower than normal.</b></p>	<ul style="list-style-type: none"> <li>• The oven has been stored in a cold area. The fan will run slower until the oven warms up to the normal room temperature.</li> </ul>
<p><b>The display indicates “:”.</b></p>	<ul style="list-style-type: none"> <li>• A power failure has occurred. Reset the clock.</li> </ul>

If none of the items above is causing the problem, refer to “Requesting Assistance or Service” on page 6-1.

# WIRING DIAGRAM & STRIP CIRCUITS

## WIRING DIAGRAM

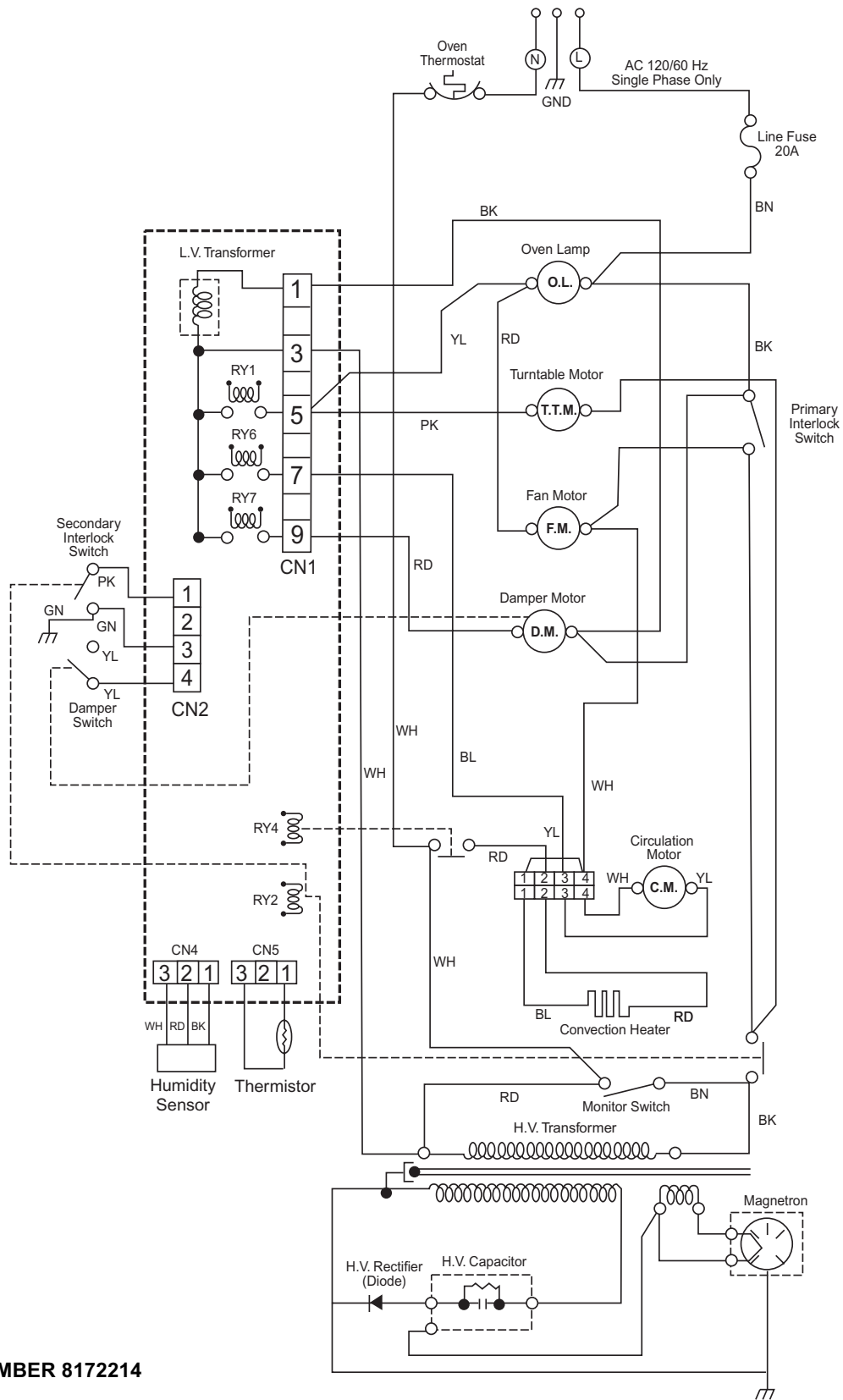

PART NUMBER 8172214

# STRIP CIRCUITS

## MICROWAVE PLUGGED IN

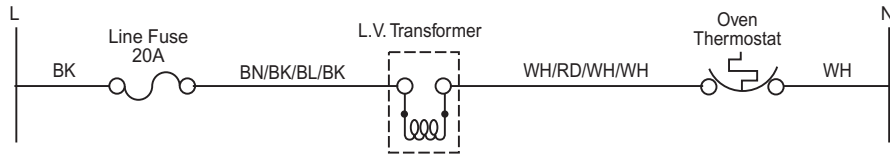

## MICROWAVE COOKING ON

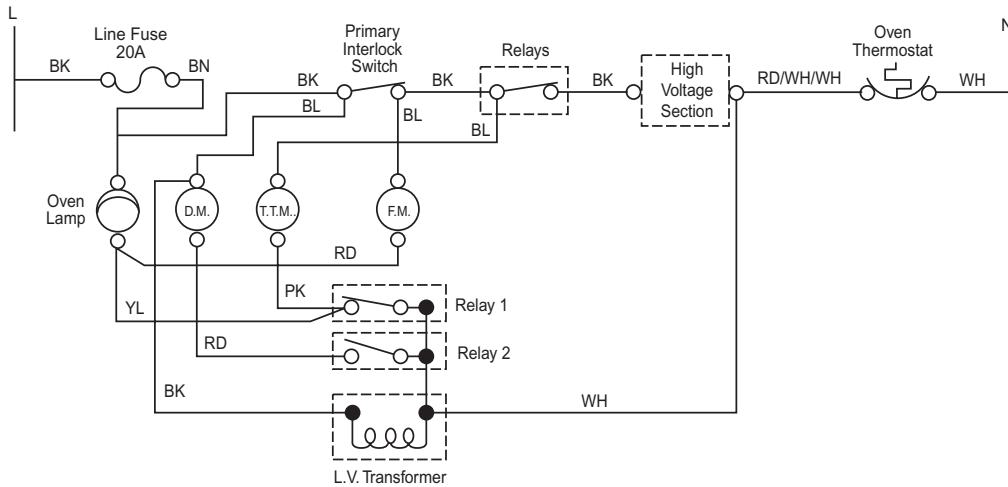

## MICROWAVE CONVECTION COOKING ON

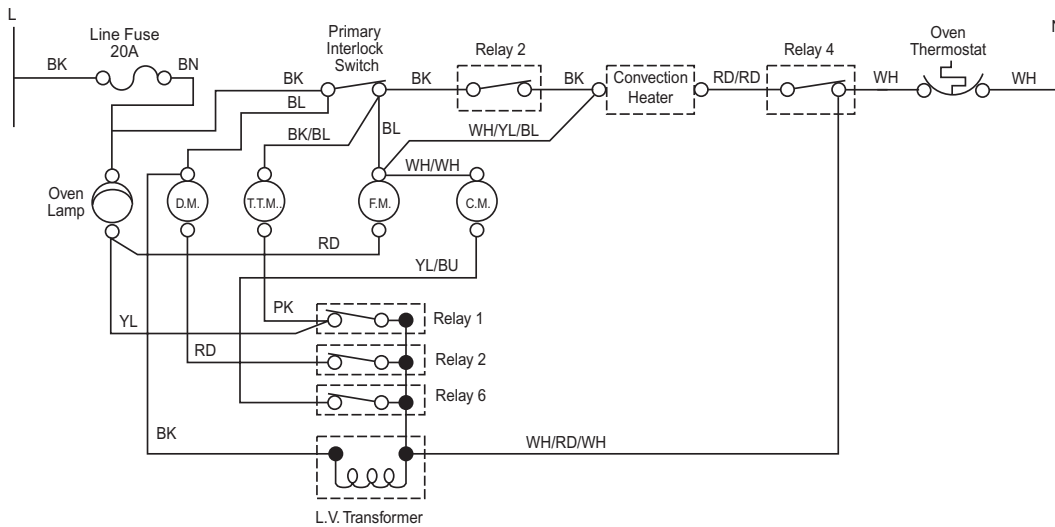

## MICROWAVE DOOR OPEN

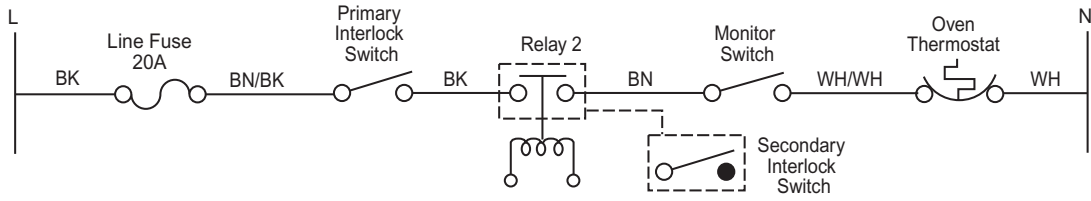

---

## MICROWAVE DOOR CLOSED

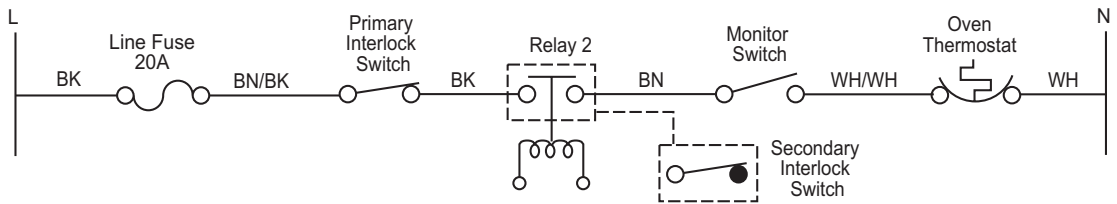

— NOTES —



# TECH TIPS

## REQUESTING ASSISTANCE OR SERVICE

To avoid unnecessary service calls, please check the “Diagnosis & Troubleshooting” on page 4-1.

If you need assistance or service, call the Whirlpool Customer Interaction Center toll free at:

**1-800-253-1301.**

Our consultants are available to assist you.

When calling, please know the purchase date, and the complete model and serial number of your appliance (see the “A Note to You” section in the Use & Care Guide). This information will help us better respond to your request.

Our consultants provide assistance with:

- Features and specifications on our full line of appliances.
- Installation information.
- Accessory and repair parts sales.
- Specialized customer assistance (Spanish speaking, hearing impaired, limited vision, etc.).
- Referrals to local dealers, service companies, and repair parts distributors.

Whirlpool-designated service technicians are trained to fulfill the product warranty, and provide after-warranty service, anywhere in the United States. To locate the Whirlpool designated service company in your area, you can also look in your telephone directory Yellow Pages.

If you need further assistance, you can write to Whirlpool Corporation with any questions or concerns at:

Whirlpool Brand Home Appliances  
Customer Interaction Center  
c/o Correspondence Dept.  
MD 8020  
553 Benson Road  
Benton Harbor, MI 49022-2400

Please include a daytime phone number in your correspondence.

# WHIRLPOOL MICROWAVE-CONVECTION OVEN WARRANTY

LENGTH OF WARRANTY:	WHIRLPOOL WILL PAY FOR:	WHIRLPOOL WILL NOT PAY FOR:
<p><b>ONE-YEAR FULL WARRANTY</b> From Date of Purchase.</p>	<p>FSP® Replacement parts and repair labor costs to correct defects in materials or workmanship. Service must be provided by a Whirlpool-designated servicing company.</p>	<p>A. Service calls to:</p> <ol style="list-style-type: none"> <li>1. Correct the installation of the microwave-convection oven.</li> <li>2. Instruct you how to use the microwave-convection oven.</li> <li>3. Replace house fuses or correct house wiring.</li> <li>4. Replace owner-accessible light bulbs.</li> </ol> <p>B. Repairs when microwave-convection oven is used in other than normal single-family household use.</p>
<p><b>LIMITED FOUR-YEAR WARRANTY</b> Second through fifth year from Date of Purchase.</p>	<p>FSP® Replacement magnetron tube on microwave-convection ovens if defective in materials or workmanship.</p>	<p>C. In-home service. Your microwave-convection oven must be taken to a Whirlpool-designated service company, except when your microwave oven is installed over an approved oven using an approved built-in kit.</p> <p>D. Damage to the microwave-convection oven resulting from accident, alteration, misuse, abuse, fire, flood, acts of God, or use of products not approved by Whirlpool Corporation.</p> <p>E. Any labor costs during the limited warranty.</p> <p>F. Repairs to parts or systems resulting from unauthorized modifications made to the appliance.</p> <p>G. Replacement parts or repair labor costs for units operated outside the United States.</p>

**WHIRLPOOL CORPORATION SHALL NOT BE LIABLE FOR INCIDENTAL OR CONSEQUENTIAL DAMAGES.** Some states do not allow the exclusion or limitation of incidental or consequential damages, so this exclusion or limitation may not apply to you. This warranty gives you specific legal rights, and you may also have other rights which vary from state to state.

**Outside the 50 United States, this warranty does not apply. Contact your authorized Whirlpool dealer to determine if another warranty applies.**

If you need service, first see “Diagnosis & Troubleshooting” on page 4-1. After checking “Diagnosis & Troubleshooting,” additional help can be found by checking the “Requesting Assistance or Service” on the previous page, or by calling our Customer Interaction Center telephone number, **1-800-253-1301**, from anywhere in the U.S.A.

