



CONSUMER SERVICES TECHNICAL  
EDUCATION GROUP PRESENTS

L-68



## Front-Loading Automatic Washer



**Model Numbers:**  
GHW9100L GHW9200L

JOB AID  
Part No. 8178076



## FORWARD

This Whirlpool Job Aid, “Front-Loading Automatic Washer,” (Part No. 8178076), provides the technician with information on the installation and service of the Front-Loading Automatic Washer. It is to be used as a training Job Aid and Service Manual. For specific information on the model being serviced, refer to the “Use and Care Guide” or “Tech Sheet” provided with the washer.

The Wiring Diagram used in this Job Aid is typical and should be used for training purposes only. Always use the Wiring Diagram supplied with the product when servicing the unit.

## GOAL AND OBJECTIVES

The goal of this Job Aid is to provide detailed information that will enable the service technician to properly diagnose malfunctions and repair the Whirlpool Front-Loading Automatic Washer.

The objectives of this Job Aid are:

- Understand and follow proper safety precautions.
- Successfully troubleshoot and diagnose malfunctions.
- Successfully perform necessary repairs.
- Successfully return the washer to its proper operational status.



WHIRLPOOL CORPORATION assumes no responsibility for any repairs on our products by anyone other than Authorized Service Technicians.

# TABLE OF CONTENTS

<b>GENERAL INFORMATION</b> .....	1-1
Safety First .....	1-1
Model/Serial Number Designators .....	1-2
Specifications .....	1-3
Pedestal Warranty .....	1-3
Washer Warranty .....	1-4
<b>INSTALLATION CONSIDERATIONS</b> .....	2-1
Installation Requirements .....	2-1
Installation Instructions (Washer) .....	2-3
Installation Instructions (Pedestal) .....	2-6
<b>THEORY OF OPERATION</b> .....	3-1
<b>COMPONENT ACCESS</b> .....	4-1
Component Location .....	4-1
Component Access .....	4-2
<b>COMPONENT TESTING</b> .....	5-1
Central Control Unit .....	5-1
Component Checks .....	5-2
Motor Control Unit .....	5-4
Line Filter .....	5-5
Dispenser .....	5-5
Pressure Switch .....	5-6
Heating Element and Temperature Sensor .....	5-6
<b>DIAGNOSIS AND TROUBLESHOOTING</b> .....	6-1
Suds Detection .....	6-1
Door Locking and Unlocking .....	6-2
Unbalance Detection Routine .....	6-3
Error Codes .....	6-4
Diagnostic Test .....	6-8
Troubleshooting Chart .....	6-10
Cycle Charts .....	6-12
<b>WIRING DIAGRAM</b> .....	7-1
<b>TECH TIPS</b> .....	8-1

**-- NOTES --**

# GENERAL

## IMPORTANT SAFETY INFORMATION

**Your safety and the safety of others are very important.**

We have provided many important safety messages in this manual and on the appliance. Always read and obey all safety messages.



This is the safety alert symbol.

This symbol alerts you to potential hazards that can kill or hurt you and others.

All safety messages will follow the safety alert symbol and either the word "DANGER" or "WARNING." These words mean:

**! DANGER**

**You can be killed or seriously injured if you don't immediately follow instructions.**

**! WARNING**

**You can be killed or seriously injured if you don't follow instructions.**

All safety messages will tell you what the potential hazard is, tell you how to reduce the chance of injury, and tell you what you can happen if the instructions are not followed.

**! WARNING**



**ELECTRICAL SHOCK HAZARD**

**Disconnect power before servicing.**

**Replace all panels before operating.**

**Failure to do so can result in death or electrical shock.**

**! WARNING**



**ELECTRICAL SHOCK HAZARD**

**Plug into a grounded 3 prong outlet.**

**Do not remove ground prong.**

**Do not use adapter.**

**Do not use an extension cord.**

**Failure to follow these instructions can result in death, fire, or electrical shock.**

**! WARNING**

**Excessive Weight Hazard**

**Use two or more people to move and install washer.**

**Failure to do so can result in back or other injury.**

# WHIRLPOOL MODEL & SERIAL NUMBER DESIGNATORS

## MODEL NUMBER

MODEL NUMBER	<b>G</b>	<b>H</b>	<b>W</b>	<b>9100</b>	<b>L</b>	<b>W</b>	<b>0</b>
PRODUCT GROUP G = Gold Line Laundry							
PRODUCT IDENTIFICATION H = Horizontal Axis - Domestic							
FEATURE CODE W = Resource Saving							
FEATURE CODE 9100 = Non-Heated 9200 = Heated							
YEAR OF INTRODUCTION L = 2002							
COLOR CODE W = White/Grey Q = White/Blue							
ENGINEERING CHANGE 0 = Basic Release; 1 = First Revision; 2 = Second Revision							

## SERIAL NUMBER

SERIAL NUMBER	<b>CS</b>	<b>L</b>	<b>36</b>	<b>50001</b>
MANUFACTURING SITE CS = Schorndorf, Germany				
YEAR OF MANUFACTURE L = 2001				
WEEK OF MANUFACTURE				
PRODUCT SEQUENCE NUMBER				

**Tech Sheet  
(Right Side  
Panel)**

**Model/Serial  
Number Plate  
(Left side of  
Door Opening)**



## SPECIFICATIONS

<b>Model Number</b>	GHW9100LW/Q	GHW9200LW/Q
<b>Color</b>	W = White/Grey Q = White/Blue	W = White/Grey Q = White/Blue
<b>Electrical Requirements</b>		
Heating Power	No Heating Element	1,000W
Max. Current	12A	12A
Rated Current	15A	15A
Voltage	120V	120V
Frequency	60Hz	60 Hz
<b>Gallons/Normal Cycle</b>	15.8 Gal./60 L	15.8 Gal./60 L
<b>Capacity</b>	19.8 lbs. (9 kg.)	19.8 lbs. (9 kg.)
<b>Volume</b>	3.7 cu. ft. (IEC equivalent)	3.7 cu. ft. (IEC equivalent)
<b>Max. Spin Speeds</b>	900 RPM	1100 RPM
<b>Dimensions</b>		
Height	37.4" (950mm)	37.4" (950mm)
Height (Feet Extended)	38.2" (970mm)	38.2" (970mm)
Width	27" (686mm)	27" (686mm)
Depth	30.3" (770mm)	30.3" (770mm)
Weight	245 lbs. (111kg.)	245 lbs. (111kg.)
<b>Installation Options</b>	Pedestal Stackable	Pedestal Stackable
<b>Programs</b>		
Program Selector	Rotary 8 Programs	Rotary 12 Programs
Temperature Selector	Buttons (3 levels)	Buttons (5 levels)
Spin Speed	Buttons (4 levels)	Buttons (5 levels)

## WHIRLPOOL PEDESTAL WARRANTY

### Full One-Year Warranty on Mechanical parts.

For one year from the date of purchase, when this **Pedestal** is installed with the listed washer or dryer and operated according to the instructions provided in the washer or dryer Owner's Manual or Use and Care Guide, supplier will repair or replace any of its mechanical parts if defective in material or workmanship.

### Warranty Restriction

If the **Pedestal** is subject to other than private family use and or used with any other product than those listed in the installation instructions, the warranty is null and void.

# WARRANTY

## WHIRLPOOL WASHER WARRANTY

LENGTH OF WARRANTY:	WHIRLPOOL WILL PAY FOR:	WHIRLPOOL WILL NOT PAY FOR:
<b>FULL ONE-YEAR WARRANTY</b> FROM DATE OF PURCHASE	FSP® replacement parts and repair labor costs to correct defects in materials or workmanship. Service must be provided by a Whirlpool-designated service company.	<p>A: Service calls to:</p> <ol style="list-style-type: none"> <li>1. Correct the installation of the washer</li> <li>2. Instruct you how to use the washer.</li> <li>3. Replace house fuses or correct house wiring.</li> </ol> <p>B. Repairs when the washer is used in other than normal, single-family house hold use.</p> <p>C. Pickup and delivery. The washer is designed to be repaired in the home.</p> <p>D. Damage to the washer caused by accident, alterations, misuse, abuse, fire, flood, acts of God, or use of products not approved by Whirlpool.</p> <p>E. Repairs to parts or systems resulting from unauthorized modifications made to the washer.</p> <p>F. Replacement parts or repair labor costs for units operated outside the United States.</p>
<b>LIMITED TWO-YEAR WARRANTY</b> FROM DATE OF PURCHASE	For two years from the date of purchase, FSP® replacement parts only to correct defects in the electronic control boards if defective in material or workmanship.	
<b>LIMITED FIVE-YEAR WARRANTY</b> FROM DATE OF PURCHASE	For five years from the date of purchase, FSP® replacement parts only to correct defects in the drive system belt and pulley if defective in material or workmanship.	
<b>LIMITED FIVE-YEAR WARRANTY</b> FROM DATE OF PURCHASE	For five years from the date of purchase, FSP® replacement parts only to correct defects in the porcelain top, (GHW9200), or powder coat top, (GHW9100), if defective in material or workmanship.	
<b>LIMITED TEN-YEAR WARRANTY</b> FROM DATE OF PURCHASE	For ten years from the date of purchase, FSP® replacement parts only to correct defects in the plastic tub if defective in material or workmanship.	
<b>LIMITED LIFE-TIME WARRANTY</b> FROM DATE OF PURCHASE	For the life of the washer from the date of purchase, FSP® replacement parts only to correct defects in the stainless steel basket if defective in material or workmanship.	



# INSTALLATION INFORMATION

## INSTALLATION REQUIREMENTS

### Tools and Parts

Assemble the necessary tools and supplies before beginning the washer installation. The parts supplied are in the washer basket.

#### Tools needed for connecting the water inlet hoses

- Pliers (that open to 1 9/16 in.)
- Flashlight (optional)

#### Tools needed for installation

- Open end wrench 5/8 in. (17 mm) and 1/2 in. (13 mm)
- Level
- Wood block (2" x 4")
- Ruler or measuring tape

#### Parts supplied:



Beaded strap



Transport Bolt Hole Plug (4)

### Alternate Parts You May Need

#### If You Have

#### You Will Need to Buy

Laundry tub or standpipe taller than 96 in. (2.4 m)

Sump pump system (if not already available)

Overhead sewer

Standard 20 gal. (76 L), 30 in. (76.2 cm) tall drain tub or utility sink and sump pump (available from local plumbing suppliers)

Floor drain

Siphon break, Part Number 285834; additional drain hose Part Number 8318155; and connector kit, Part Number 285835

Drain hose too short

Drain hose extension kit, Part Number 285863

Water faucets beyond reach of fill hoses

2 longer water fill hoses: 6 ft. (1.8 m) Part Number 76314, 10 ft. (3.0 m) Part Number 350008

### Optional Pedestal

A pedestal may be purchased separately for this washer. This pedestal will add about 14 inches to the height of your unit for a total vertical height of approximately 52 inches (132 cm).



Optional Pedestal

### Location Requirements

Selecting the proper location for your washer improves performance and minimizes noise and possible washer "walk."

Your washer can be installed under a custom counter, or in a basement, laundry room, closet, or recessed area. (See "Drain System.")

Companion appliance location requirements should also be considered. Proper installation is your responsibility.

### You will need

- A water heater set to deliver 120°F (49°C) water to the washer.
- A grounded electrical outlet located within 5 ft. (1.5 m) of where the power cord is attached to the back of the washer. (See "Electrical Requirements.")
- Hot and cold water faucets located within 4 ft. (1.2 m) of the hot and cold water fill valves, and water pressure of 20-100 psi (137.9-689.6 kPa).
- A level floor with a maximum slope of 1 in. (2.5 cm) under entire washer. Installing the washer on carpeting is not recommended.
- A sturdy and solid floor to support the washer with a total weight (water and load) of 400 lbs. (180 kg).

Do not operate your washer in temperatures below 32°F (0°C). Some water can remain in the washer and can cause damage in low temperatures.

## Washer Dimensions

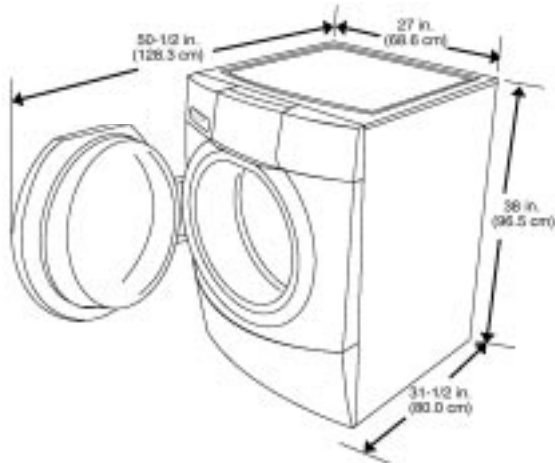

### Custom undercounter installation

The dimensions shown are for the minimum spacing allowed.

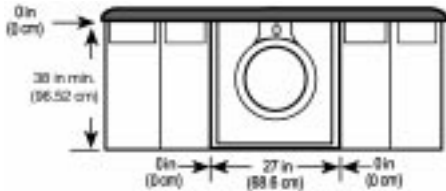

### Recessed area or closet installation

The dimensions shown are for the minimum spacing allowed.

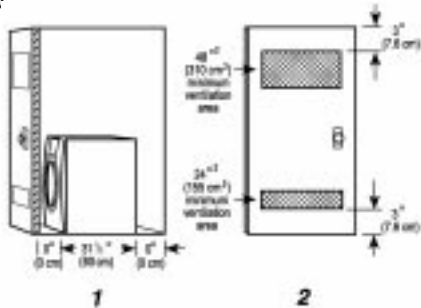

1. Side view - closet or confined area  
2. Closet door with vents

- Additional spacing should be considered for ease of installation and servicing.
- Additional clearances might be required for wall, door and floor moldings.
- Additional spacing of 1 in. (2.5 cm) on all sides of the washer is recommended to reduce noise transfer.
- For closet installation, with a door, the minimum ventilation openings in the top and bottom of the door are required (view 2). Louvered doors with equivalent ventilation openings in the top and bottom are acceptable.

## Drain System

The washer can be installed using the standpipe drain system (floor or wall), the laundry tub drain system, or the floor drain system. Select the drain hose installation method you need. (See “Alternate Parts You May Need.”)

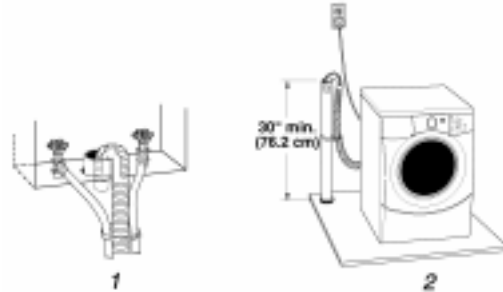

### Standpipe drain system - wall or floor (view 1 & 2)

The standpipe drain requires a minimum diameter standpipe of 2 in. (5 cm). The minimum carry-away capacity can be no less than 17 gal (64 L) per minute.

The top of the standpipe must be at least 30 in. (76.2 cm) high and no higher than 96 in. (2.4 m) from the bottom of the washer.

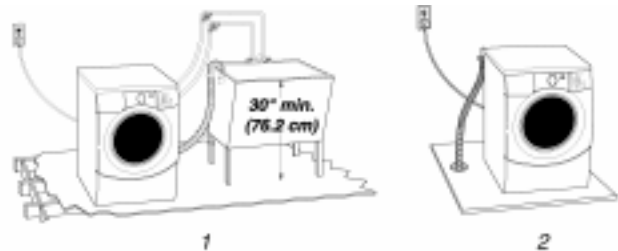

The laundry tub needs a minimum 20 gal. (76 L) capacity. The top of the laundry tub must be at least 30 in. (76.2 cm) above the floor.

### Floor drain system (view 2)

The floor drain system requires a siphon break that may be purchased separately. (See “Alternate Parts You May Need.”)

The siphon break must be a minimum of 28 in. (71 cm) from the bottom of the washer. Additional hoses might be needed.

## Electrical Requirements

### **! WARNING**



#### **ELECTRICAL SHOCK HAZARD**

**Plug into a grounded 3 prong outlet.**

**Do not remove ground plug.**

**Do not use an adapter.**

**Do not use an extension cord.**

**Failure to follow these instructions can result in death or electrical shock.**

- A 120-volt, 60-Hz., AC-only, 15- or 20-ampere, fused electrical supply is required. Time-delay fuse or circuit breaker is recommended. It is recommended that a separate circuit serving only this appliance be provided.
- This washer is equipped with a power supply cord having a 3 prong ground plug.
- To minimize possible shock hazard, the cord must be plugged into a mating, 3 prong, ground-type outlet, grounded in accordance with local codes and ordinances. If a mating outlet is not available, it is the personal responsibility and obligation of the customer to have the properly grounded outlet installed by a qualified electrician.
- If codes permit and a separate ground wire is used, it is recommended that a qualified electrician determine that the ground path is adequate.
- Do not ground to a gas pipe.
- Check with a qualified electrician if you are not sure the washer is properly grounded.
- Do not have a fuse in the neutral or ground circuit.

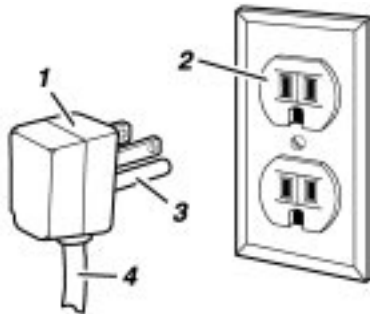

1. 3 prong grounding plug
2. 3 prong grounding-type wall receptacle
3. Grounding prong
4. Power supply cord

## GROUNDING INSTRUCTIONS

### **For a grounded, cord-connected washer:**

This washer must be grounded. In the event of a malfunction or breakdown, grounding will reduce the risk of electrical shock by providing a path of least resistance for electric current. This washer is equipped with a cord having an equipment-grounding conductor and a grounding plug. The plug must be plugged into an appropriate outlet that is properly installed and grounded in accordance with all local codes and ordinances.

**WARNING:** Improper connection of the equipment-grounding conductor can result in a risk of electric shock. Check with a qualified electrician or serviceman if you are in doubt as to whether the appliance is properly grounded.

Do not modify the plug provided with the appliance –  
if it will not fit the outlet, have a proper outlet installed by a qualified electrician.

### **For a permanently connected washer:**

This washer must be connected to a grounded metal, permanent wiring system, or an equipment grounding conductor must be run with the circuit conductors and connected to the equipment-grounding terminal or lead on the appliance.

## INSTALLATION INSTRUCTIONS

### Remove Transport System

### **! WARNING**

#### **Excessive Weight Hazard**

**Use two or more people to move and install washer.**

**Failure to do so can result in back or other injury.**

**IMPORTANT:** Position the washer so that the rear of the unit is within approximately 3 feet (90 cm) of the final location.

There are 4 bolts in the rear panel of the washer that support the suspension system during transportation.



1. Using a ½ in. (13 mm) wrench, loosen each of the bolts.
2. Once the bolt is loose, move it to the center of the hole and completely pull out the bolt, including the plastic spacer covering the bolt and the cable attached to the bolt. The power cord will be attached to all 4 bolts.



3. Once all 4 bolts are removed, remove the power cord from each bolt holder, and discard bolts, plastic spacers, and cables.
4. Close the holes with the transport bolt hole plugs.

### Route the Drain Hose

Proper routing of the drain hose protects your floors from damage due to water leakage. Carefully read and follow these instructions.

The drain hose is connected to your washer.

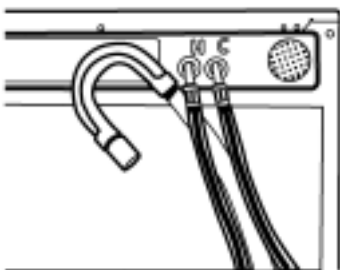

**To prevent drain water from going back into the washer:**

- Do not straighten the drain hose, and do not force excess drain hose into standpipe. Hose should be secure, but loose enough to provide a gap for air.
- Do not lay excess hose on the bottom of the laundry tub.

### Floor drain

You may need additional parts. (See Floor Drain under "Alternate Parts You May Need.")

## Connect the Inlet Hoses

### Connect the inlet hoses to the water faucets

Make sure the washer basket is empty.

1. Attach the hose with the red color indicator to the hot water faucet. Screw on coupling by hand until it is seated on the washer.
2. Attach the hose with the blue color indicator to the cold water faucet. Screw on coupling by hand until it is seated on the washer.
3. Using pliers, tighten the couplings with an additional two-thirds turn.

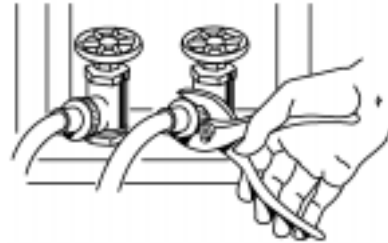

**NOTE: Do not overtighten.** Damage to the coupling can result.

4. Turn on the water faucets and check for leaks. **NOTE:** Replace inlet hoses after 5 years of use to reduce the risk of hose failure. Record hose installation or replacement dates on the hoses for future reference.

Periodically inspect and replace hoses if bulges, kinks, cuts, wear, or leaks are found.

## Secure the Drain Hose

1. Drape the power cord over the washer top.
2. Secure the drain hose to the laundry tub leg or standpipe with the beaded strap provided. (See illustration.)

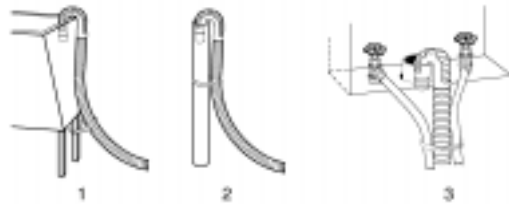

If the washer faucets and the drain standpipe are recessed, put the hooked end of the drain hose in the standpipe. Tightly wrap the beaded strap around the water inlet hoses and the drain hose.

Do not force excess drain hose into the standpipe.

## Level the Washer

Properly leveling your washer prevents excessive noise and vibration.

1. Check the levelness of the washer by placing a level on the top edge of the washer, first side-to-side, then front-to-back.

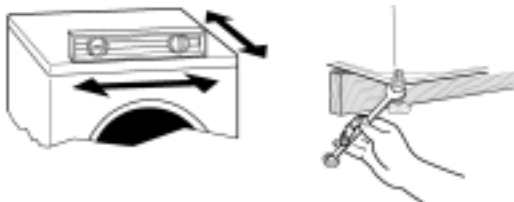

If the washer is against a wall, move the washer out slightly before tipping back. If the washer is not level, first prop the front with a wood block (2" x 4") and adjust the feet as necessary; then prop the back and adjust feet as necessary. Repeat this step until washer is level.

2. After the washer is level, use a 5/8 in. (17 mm) open-end wrench to turn the nuts on the feet tightly against the washer cabinet. All 4 feet must be tightened. If the nuts are not tight against the washer cabinet, the washer may vibrate.
3. Slide the washer to its final location.
4. Confirm the levelness of the washer.

## Complete Installation

1. Check the electrical requirements. Be sure that you have the correct electrical supply and the recommended grounding method. (See "Electrical Requirements.")
2. Check to be sure all parts are now installed. If there is an extra part, go back through the steps to see which step was skipped.

**! WARNING**



**ELECTRICAL SHOCK HAZARD**

**Plug into a grounded 3 prong outlet.**

**Do not remove ground plug.**

**Do not use an adapter.**

**Do not use an extension cord.**

**Failure to follow these instructions can result in death or electrical shock.**

3. Check to be sure you have all of your tools.
4. Dispose/recycle all packaging materials.
5. Check to be sure the water faucets are on.
6. Check for leaks around faucets and inlet hoses.
7. Plug into a grounded 3 prong outlet.
8. Read "Washer Use & Care Manual."

To test and to clean your washer, measure ½ the normal recommended amount of powdered or liquid High Efficiency (HE) detergent or ¼ the normal recommended amount of regular powdered or liquid detergent. Pour the detergent into the detergent dispenser. Select NORMAL/CASUAL, and then select START. Allow the washer to complete one whole cycle.

# INSTALLATION INSTRUCTIONS

## Pedestal

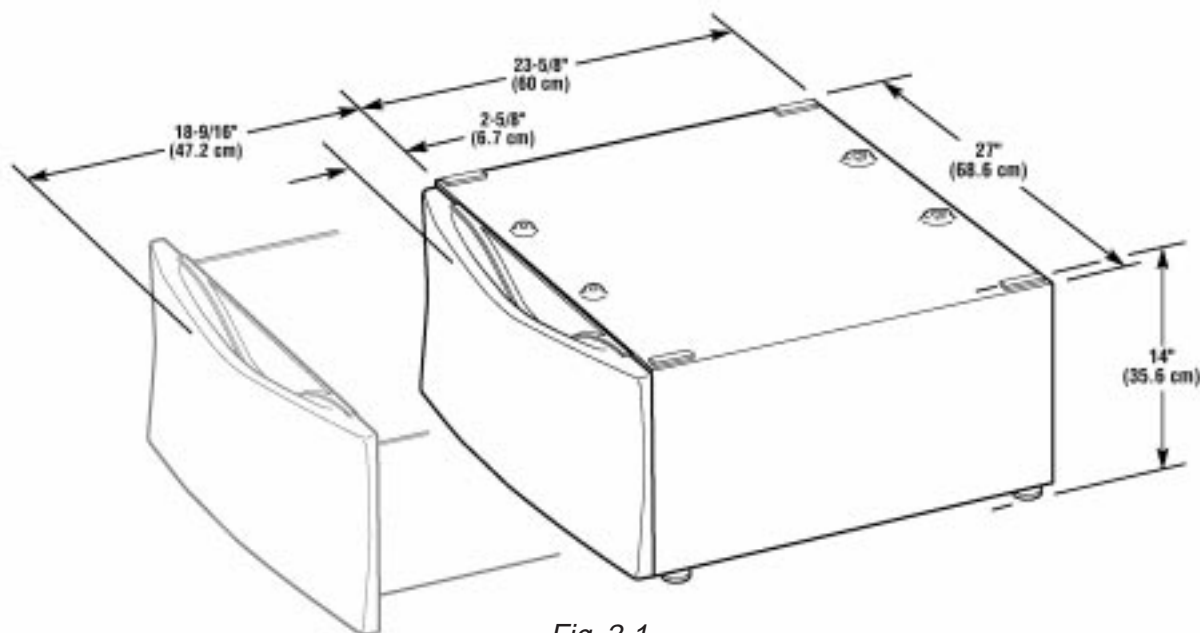

Fig. 2-1

### **! WARNING**

#### **EXCESSIVE WEIGHT HAZARD**

Use two or more people to move washer and dryer.

Failure to do so can result in back or other injury.

### **Before you start...**

**Important:** If the washer is already installed, it must be uninstalled.

See installation instructions that came with the washer for tools required.

### **Uninstalling the Washer**

1. Turn off the hot and cold water faucets.
2. Briefly start the wash cycle to release any pressure in the fill hoses.
3. Unplug the power supply cord.

4. Remove the "HOT" and "COLD" fill hoses from the back of the washer.
5. Disconnect the drain hose from the washer and drain any water in the hose into a bucket.
6. Pull the washer away from the wall so it can be tipped on its back.
7. Protect the floor with a large piece of cardboard cut from the pedestal carton. Lay the washer on its back so that the cardboard is under the entire lower back edge of the washer. (Fig. 2-2) Go to "Installing the Pedestal".

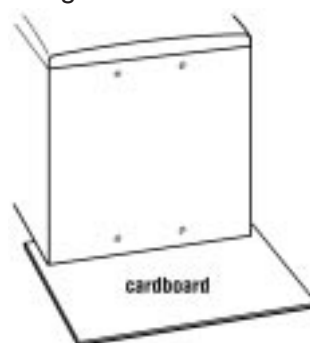

Fig. 2-2

## Installing the Pedestal

1. Open the pedestal drawer. Remove the envelope taped inside the drawer. This envelope contains four (4) #12 x 5/8" (1.6 cm) hex head sheet metal screws that will be used in Steps 4 and 5.
2. Remove the Phillips head screw from both drawer sides and set the aside. (Fig. 2-3) Remove the drawer and set it aside. Push the slides back into the pedestal.

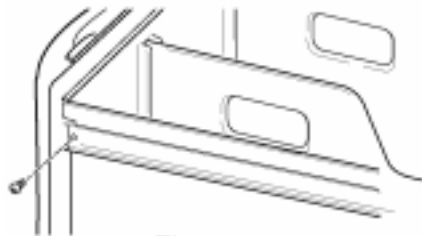

Fig. 2-3

3. The washer has feet already installed. They must be removed, prior to installing the pedestal.
4. Partially install the two (2) lower hex head sheet metal screws leaving a space of about 3/8" (2 cm) between the screw head and the bottom of the washer. (Fig. 2-4)

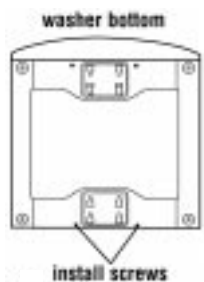

Fig. 2-4

5. Move the pedestal against the washer bottom. Slide the pedestal's keyhole slots over the lower two (2) partially installed screws. (Fig. 2-5)

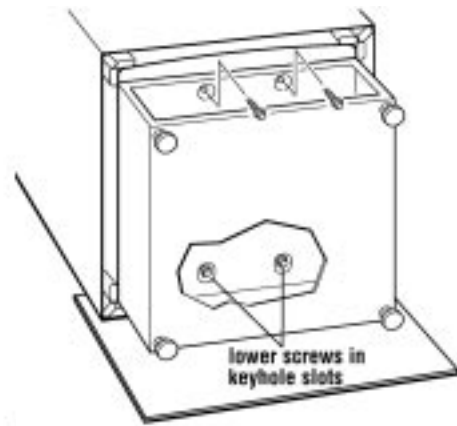

Fig. 2-5

Lift the pedestal toward the front of the washer and install the two (2) remaining hex head sheet metal screws. **Tighten all four screws completely.**

6. Tip the washer and pedestal assembly back to an upright position. Remove protective cardboard.
7. Slide the washer close to its final location.
8. Follow the Installation Instructions that came with the washer to finish installing or reinstalling. (i.e., hoses, vents, etc.)
9. Level the washer from side to side and front to back.

Place a level on the top. Locate the 1/4" hex nut on the top of each pedestal foot. Reach inside the pedestal and use a 1/4" hex head ratchet or open-end wrench to adjust the feet up or down as needed to level the washer. (Fig. 2-6)

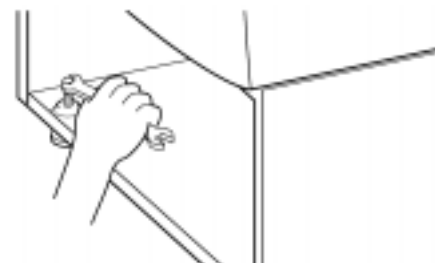
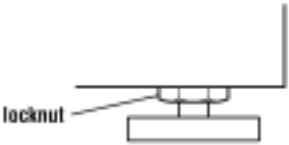

Fig. 2-6

10. When the washer is level, use a 9/16" open-end wrench to securely tighten all four (4) feet locknuts against the pedestal. *(Fig. 2-7)* **The locknuts must be tightened.**



*Fig. 2-7*

11. Pull both drawer slides out and reassemble the drawer to the drawer slides with the two (2) Phillips head screws. *(Fig. 2-8)* Use of the two (2) dividers is optional. Close the drawer.

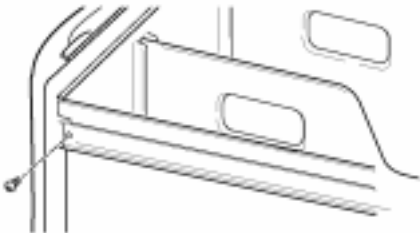

*Fig. 2-8*



# THEORY OF OPERATION

## INTRODUCTION

The **duet™** and **duet™** Front-Loading Automatic Washers present a number of new features and operating characteristics quite different from previous models. In addition to the introduction of front-loading operation, The washers contain a number of unique operating features designed to increase clothes cleaning ability while offering very high water and energy conservation.

### Water System

The water system consists of the hot and cold water inlet valves, a water temperature sensor, a water flowmeter and control and the dispenser distribution system along with a traditional pressure switch.

### Water Inlet Valves -

The hot and cold water inlet valves are located at the back of the washer. These valves receive a control signal from the Central Control Unit to manage the temperature of incoming water. The temperatures are determined by the specific wash cycle selected and a temperature sensor located in the wash tub. To improve cleaning of heavily soiled clothing and to provide a sanitizing feature, the water temperature can be increased through the use of a heating element located in the bottom of the tub, (GHW9200 model only).

### Flowmeter

Water flow, or the quantity of water introduced throughout any cycle is monitored by a flowmeter and Central Control Unit. When the flowmeter registers a maximum of 10.5 gal. (40 L), and the Central Control Unit has not detected the pressure switch trip, the water valves will be shut off and an error code will show in the digital display. The flowmeter is also used to introduce additional water into the tub for higher water levels, based on cycle requirements. Refer to page 6-12 for more details.

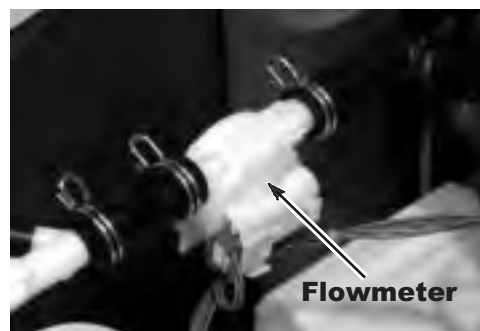

Fig. 3-1

### Dispenser Distribution System

All wash and rinse water is introduced into the wash tub through a Dispenser Distribution System located in the top left corner of the washer. The system consists of a motor that turns a cam gear. The cam follower will divert the incoming water to one or more of the follow water inlet modes:

- Detergent Dispensing
- Bleach Dispensing
- Fabric Softener Dispensing
- Rinse Dispensing (no additives)

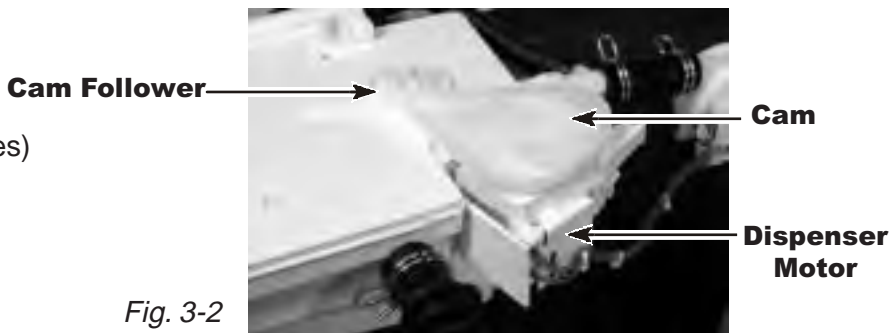

Fig. 3-2

The dispenser drawer has four separate compartments for adding laundry products to the wash load. These compartments are:

1. Prewash Detergent Compartment
2. Main Wash Detergent Compartment
3. Bleach Compartment
4. Fabric Softener Compartment

Laundry products are diluted and dispensed automatically at the proper time during the wash cycle.

The separator in the Prewash and Main Wash Detergent Compartment can be moved to accommodate either liquid or powdered detergents. (Fig. 3-4)

The drawer release lever (shown here is the normal position) can be installed in alternate position (A) to accommodate stacking a matching dryer on top of the washer. (Fig. 3-4)

Refer to Use and Care Guide for the Front-Loading Automatic washer for proper use of laundry products.

There are two routes for the water to enter the wash tub. Most of the water flows through the dispenser assembly. A small portion of the water flow around the dispensers and is used to wash the door window.

1. Main Inlet Tube (Fig. 3-5, A)
2. Window Washer Inlet Tube (Fig. 3-5, B)

### Air Vent System

As a safety feature, the washer is designed to allow fresh air to circulate through the tub. An inlet vent at the rear of the washer brings air into the tub. (Fig. 3-6A) The fresh air is vented through the dispenser assembly vent tube and out the front of the dispenser drawer cutout. (Fig. 3-6B)

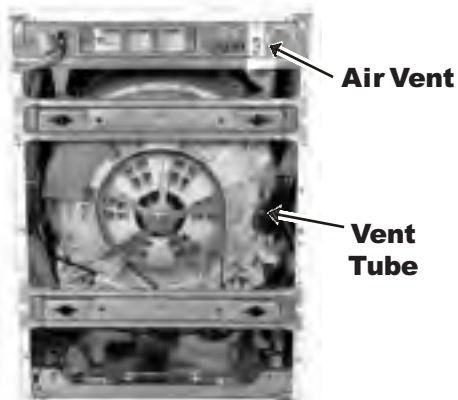

Fig. 3-6A

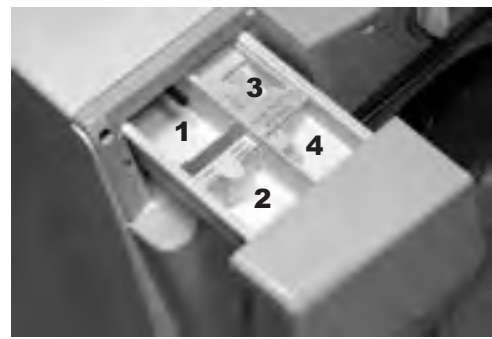

Fig. 3-3

### Separator in Front Position

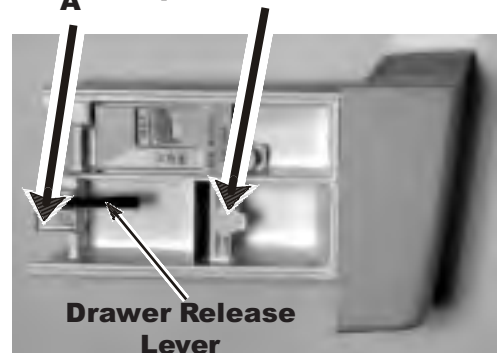

Fig. 3-4

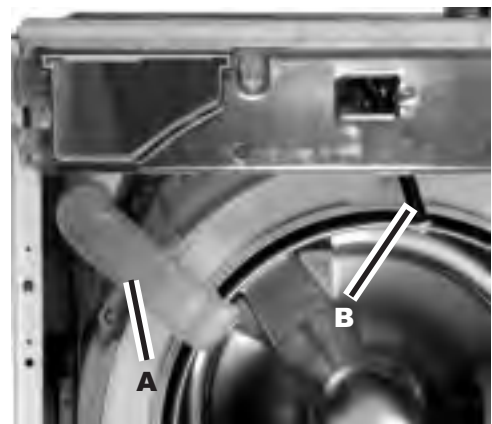

Fig. 3-5

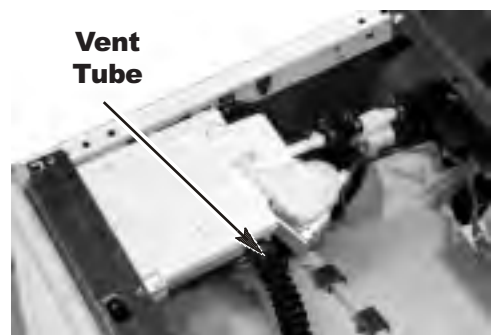

Fig. 3-6B

## Pressure Switch

The pressure switch is located in the top right rear corner of the washer. (Fig. 3-7) This switch senses water level in the wash tub. The control signal from the pressure switch is sent to the Central Control Unit and is used to determine the amount of water introduced into the wash tub during the wash cycle.

The pressure switch also senses the suds level in the wash tub. If excessive sudsing occurs, the washer starts an automatic suds routine. The display will show the word "Sud". The automatic suds routine adds additional rinse and drain operations until the suds level is reduced.

If an overfill condition is detected by the pressure switch, the CCU will turn on the drain pump and attempt to stop filling.

**Pressure Switch**



Fig. 3-7

## Customer Interface and Cycle Selection

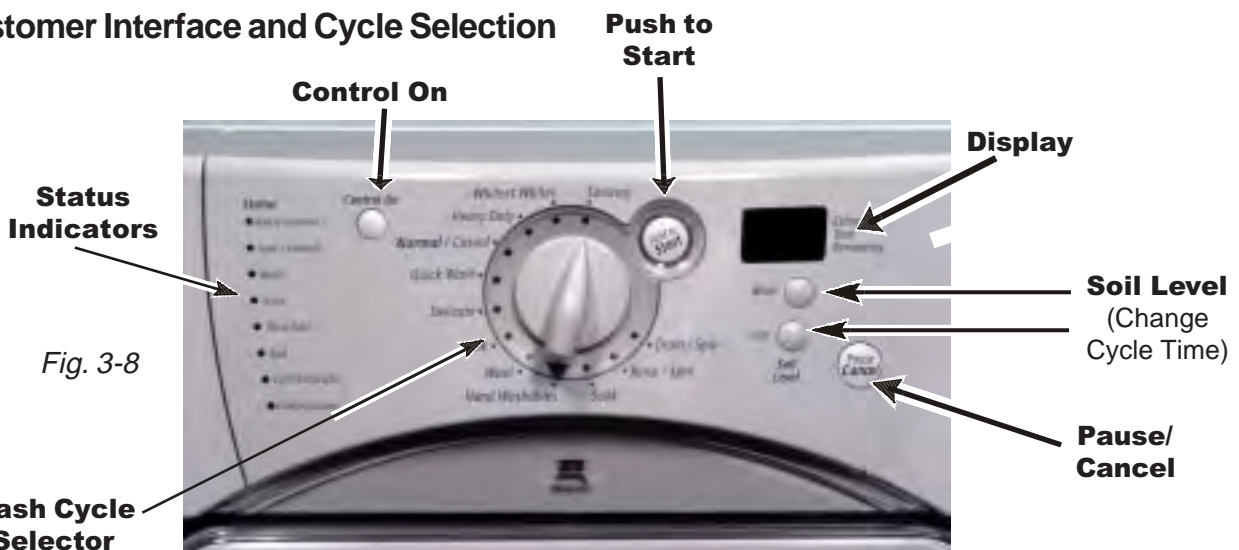

Fig. 3-8

**Control On** - The Control On button must be pressed before initiating any cycle selection.

**Status Indicators** - These lights show which portion of the cycle the washer is operating. They also indicate when additional items can be added to the wash cycle and when the controls are locked.

**Wash Cycle Selector** - Choose a Wash Cycle by turning the knob to the desired cycle. Each cycle is designed for different types of fabric and soil levels. (See Table 3-1, Page 3-5)

**Display** - The display provides such information as time remaining for selected wash cycle and error codes.

**Soil Level** - Pressing this button will change the length of the wash cycle. Heavy will add time to a normal wash cycle, light will shorten a normal wash cycle.

**Push to Start** - The Push to Start button must be pressed to initiate any wash cycle. Press and hold the START button for one second.

**Pause/Cancel** - Pressing this button will allow changing any option or changing a wash cycle after the wash cycle has begun. Press the PAUSE/CANCEL button, select the desired Option, press and hold the START button for one (1) second. To cancel a cycle and select a new one, press the PAUSE/CANCEL button, select the new cycle, select the desired options, press and hold the START button for one (1) second.

## CYCLE DESCRIPTION

### **Sanitary**

Use this cycle to clean heavily soiled colorfast fabrics. This cycle combines a very hot water temperature and fast speed tumbling to help ensure the removal of heavy soils and stains. It is recommended that you set your hot water heater to 120° F (49° C) to ensure proper performance during this cycle. The Sanitary cycle also helps kill bacteria, even when no bleach is used. Extra high speed spin helps shorten drying time. The heating element in the tub will heat the wash water to 153°F during this cycle.

### **Whitest Whites**

This cycle is especially designed for cleaning loads of soiled white fabrics with the addition of bleach. Hot washing temperatures assure optimal bleach activity. An additional rinse provides optimal rinse performance to avoid chlorine residues on your laundry. This cycle combines fast speed tumbling, longer wash time, and extra high speed spin to shorten drying time.

### **Heavy Duty**

Use this cycle to wash loads of sturdy, colorfast fabrics and normally soiled garments. This cycle combines fast speed tumbling, longer wash time, and extra high speed spin to shorten drying times. If the water temperature is lower than needed for this cycle, the heater will warm the water to the optimum temperature.

### **Normal/Casual**

Use this cycle to wash loads of no-iron fabrics such as sport shirts, blouses, casual business clothes, permanent press blends, cottons and linens, and synthetic fabrics. This cycle combines medium speed tumbling, high speed spin, and a load cooling process to reduce wrinkling.

### **Quick Wash**

Use this cycle to wash small loads of lightly soiled garments that are needed in a hurry. This cycle combines fast speed tumbling, a shortened wash time, and extra high speed spin to shorten drying time.

### **Delicate**

Use this cycle to wash sheer fabrics and lingerie. This cycle combines low speed tumbling and low speed spin for gentle fabric care.

### **Silk**

Use this cycle to clean washable silk garments. (Check label instructions to make sure that garment is washable.) This cycle gently tumbles and drains without spinning to gently clean garments and minimize wrinkling. Because there is no spinning action, garments will contain a higher amount of water at the end of this cycle.

### **Wool**

Use this cycle to clean washable woolen garments. (Check label instructions to make sure that garment is washable.) This cycle features gentle tumbling and low speed spin to minimize creasing and shrinkage.

### **Hand Washables**

Use this cycle to clean hand washable and special-care garments. Similar to the way garments are hand washed in a sink, the wash action of this cycle combines periods of extra low speed tumbling and soaking. Extra low speed spin reduces wrinkling.

<b>PRESET CYCLE SETTINGS</b>			
<b>Cycle</b>	<b>Soil level</b> (cycle time)	<b>Water Temp</b>	<b>Spin Speed</b>
<b>Sanitary</b>	More (120 min.)	Extra Hot/Cold	Extra High
<b>Whitest Whites</b>	More (70 min.)	Hot/Cold	Extra High
<b>Heavy Duty</b>	More (90 min.)	Hot/Cold	Extra High
<b>Normal/Casual</b>	Normal (45 min.)	Warm/Cold	High
<b>Quick Wash</b>	Less (30 min.)	Warm/Cold	Extra High
<b>Delicate</b>	Normal (35 min.)	Warm/Cold	Medium
<b>Silk</b>	Normal (30 min.)	Cold/Cold	No Spin
<b>Wool</b>	Normal (35 min.)	Cold/Cold	Medium
<b>Hand Washables</b>	Normal (35 min.)	Cold/Cold	Extra Low

Table 3-1

### **Soak**

Use the Soak cycle to remove small spots of set-in stains on fabrics. This cycle provides a soak time with warm or cold water followed by drain. Extra water, a short tumbling phase for equal distribution of the laundry, and a soaking time without basket movement improve the removal of set-in stains. Drain without spin assures gentle treatment even for delicate articles.

### **Rinse/Spin**

Use the Rinse/Spin cycle to get a rinse and spin only. This cycle combines fast speed tumbling and extra high speed spin. If desired, you can reduce the spin speed by selecting the speed you want from the SPIN SPEED modifier. A Rinse/Spin cycle is useful for loads that need rinsing only or for adding fabric softener to a load.

### **Drain/Spin**

Use the Drain/Spin cycle to drain your washer or to drain and spin your wash load. The spin speed is preset to extra high. If desired, you can reduce the spin speed by selecting the speed you want from the SPIN SPEED modifier.

**NOTE:** Loads of synthetics, delicate fabrics, handwashables, and woolens should be drained with no spin or low spin speed to avoid fabric stress.

# Option Selection

D = Default, X = Available, - = Not Available

## MODEL GHW9200L

CYCLE NAMES	OPTIONS						SOIL LEVEL MODIFIERS						WATER TEMPERATURES						SPIN SPEEDS					
	Prewash	Ex-Rinse	Rinse Hold	Auto Soak	More	Norm	Less	C/C	W/C	W/W	H/C	Super H/C	ExH 1100	H 1000	M 800	Ex L 300	No Spin							
Main Cycles																								
Sanitary	X	X	X	X	X	D	X	-	-	-	-	D	D	X	X	X	X							
Whitest Whites	X	D	X	X	X	D	X	X	X	X	D	-	D	X	X	X	X							
Heavy Duty	X	X	X	X	X	D	X	X	X	X	D	-	D	X	X	X	X							
Normal/Casual	X	X	X	X	X	D	X	X	X	X	D	-	X	D	X	X	X							
Quick Wash	-	X	X	X	X	D	X	X	X	X	-	-	D	X	X	X	X							
Delicate	X	X	X	X	X	D	X	X	X	X	-	-	-	X	D	X	X							
Silk	-	X	X	-	X	D	X	D	X	X	-	-	-	-	-	-	D							
Wool	-	X	X	-	X	D	X	D	X	X	-	-	-	X	D	X	X							
Hand Washables	-	X	X	-	X	D	X	D	X	X	-	-	-	-	X	D	X							
Mini Cycles																								
Soak	-	-	-	-	X	D	X	X	D	X	-	-	-	-	-	-	-							
Rinse/Spin	-	X	X	-	-	-	-	D	X	X	-	-	D	X	X	X	-							
Drain/Spin	-	-	-	-	-	-	-	-	-	-	-	-	D	X	X	X	X							

Table 3-2

## MODEL GHW9100L

CYCLE NAMES	options						SOIL LEVEL MODIFIERS						WATER TEMPERATURES						spin speeds					
	Ex-Rinse	Rinse Hold	More	Norm	Less	C/C	W/C	H/C	H 900	M 800	Ex L 300	No Spin												
Main Cycles																								
Whitest Whites	D	X	X	D	X	X	X	D	D	X	X	X												
Heavy Duty	X	X	X	D	X	X	D	X	D	X	X	X												
Normal/Casual	X	X	X	D	X	X	D	X	D	X	X	X												
Delicate	X	X	X	D	X	X	D	-	X	D	X	X												
Handwash	X	X	X	D	X	D	X	-	-	X	D	X												
Mini Cycles																								
Soak	-	-	X	D	X	X	D	-	-	-	-	-												
Rinse/Spin	X	X	-	-	-	D	X	-	D	X	X	-												
Drain/Spin	-	-	-	-	-	-	-	-	D	X	X	X												

Table 3-3

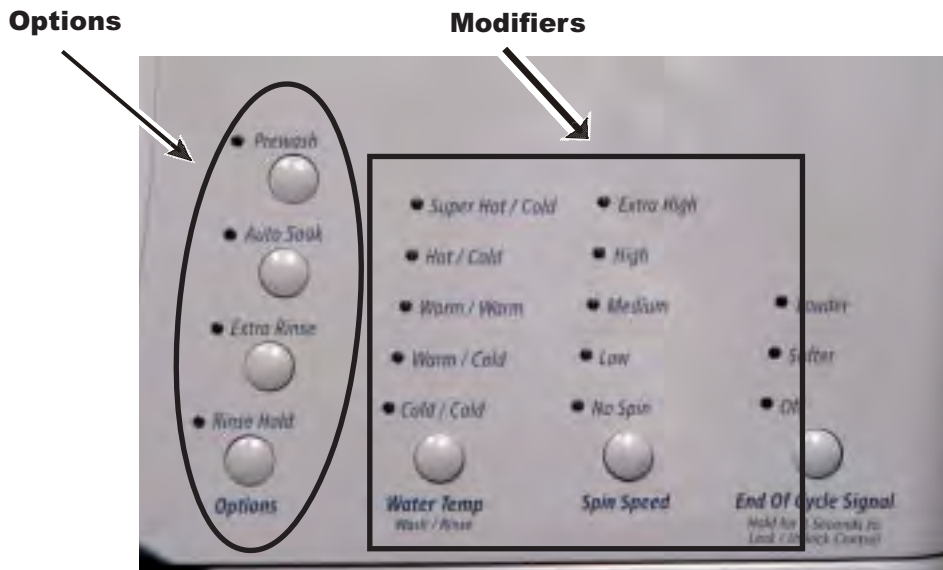

Fig. 3-9

## Options

You can customize your wash by adding OPTIONS to your cycle selections. You can add or change an option after starting a cycle anytime before the selected option begins.

- See the “Laundry Guide” for an overview of possible options for each Wash Cycle selection.
- You can select more than one option for a cycle. Some options cannot be added to some cycles. See Tables on previous page.
- If an option is available with a selected cycle, the light for that option will glow when selected.
- If an option is unavailable with a selected cycle, there will be a short tone and the light for that option will **not** glow when selected.

## Prewash

Use this option for heavily soiled loads that need pretreatment. This option adds a 15 minute prewash and drain to the main wash cycle.

- Add detergent to the Prewash and Main Wash compartments of the Dispenser Drawer.
- When using Prewash, do not use liquid detergent in the Main Wash compartment. Use powdered detergent for the main wash cycle.

**NOTE:** The Prewash and Auto Soak options cannot be selected in the same cycle.

## Auto Soak

Use the Auto Soak option for loads of heavily soiled cotton, linen, polyester or nylon with set-in stains. During Auto Soak, water will be added to the basket and the laundry will be equally distributed by a short tumbling phase. Laundry will then be soaked in phases without basket movement. After soaking, the washer drains without spinning.

**Added to a Wash Cycle:** A 30 minute soak time is added to the main wash cycle to improve removal of set-in stains.

1. Add detergent to both the Prewash and Main Wash compartments of the Dispenser Drawer.

**NOTE:** The Auto Soak and Prewash options cannot be selected in the same cycle. Use powdered detergent for the main wash cycle because liquid detergent will seep into the washer during Auto Soak.

2. Select a Wash Cycle.
3. Select AUTO SOAK.

**NOTE:** For cycles with hot wash temperatures, the soak temperature will be set to warm; otherwise, the soak temperature will be the same as the wash temperature.

4. Select and hold START (approximately 1 second). After soaking, the washer drains and the wash cycle starts.

**Without a Wash Cycle:** Provides a soak time with warm or cold water followed by drain.

1. Add detergent only to the Prewash compartment of the Dispenser Drawer.
2. Select DRAIN/SPIN or RINSE/SPIN first, then AUTO SOAK.
3. Choose the desired soak temperature.
4. Select and hold START (approximately 1 second).

**Extra Rinse**

A second rinse can be used to ensure the removal of detergent or bleach residue from garments. This option provides an additional rinse with the same water temperature as the first rinse.

**Rinse Hold**

Use this option to avoid wrinkling of your laundry when a load cannot be removed from the washer immediately. The wash cycle is paused before the final drain and spin phase so that the laundry stays in the rinse water until the cycle is continued. This provides optimal wrinkle care of your wet laundry. The door stays locked during the Rinse Hold cycle and the indicator light is flashing. Press RINSE HOLD to finish the cycle and unload the washer.

**Modifiers**

Preset cycle settings of Water Temperature, Wash/Rinse, and Spin Speed can be changed. You can change a modifier after starting a cycle anytime before the selected modifier begins.

- To change the water temperature, select the WATER TEMP button until the desired setting glows.
- To change the spin speed, select the SPIN SPEED button until the desired setting glows.
- To change the loudness of the End of Cycle Signal, select END of CYCLE SIGNAL.

**Wash/Rinse Temp**

Select a water temperature based on the type of load you are washing. Use the warmest water safe for fabrics. Follow garment label instructions.

Warm rinses leave the loads dryer than cold rinses. Warm rinses increase wrinkling. In cold climates, a warm rinse makes the load more comfortable to handle. Cold rinses save energy.

**Auto Temp Control**

ATC (Auto Temp Control) electronically senses and maintains a uniform water temperature. ATC regulates incoming hot and cold water. The ATC is automatically turned ON when a cycle is selected.

- ATC ensures consistent cleaning.
- ATC works for the wash temperature with Extra Hot/Cold, Hot/Cold, Warm/Warm, Warm/Cold, and Cold/Cold settings.
- The Cold rinse temperatures depend on the cold water at the tap.
- For the Tap Cold/Cold setting, both wash and rinse temperatures depend on the cold water at the tap.
- The Warm rinse setting regulates the water temperature at approximately 104°F (40°C).

**Water Temperature Guide**

Wash Water Temperature	Suggested Fabrics
<b>EXTRA HOT</b> 153°F (67°C)	Heavily soiled whites, diapers, towels
<b>HOT</b> 127°F (53°C) WW/HD 122°F (50°C) NORMAL	Whites and pastels Heavy Soils
<b>WARM</b> 104°F (40°C)	Bright colors Moderate to light soils
<b>COLD</b> 77°F (25°C)	Colors that bleed or fade Light soils

Table 3-4



## Touch Pad/LED Assembly

**Touchpad/LED  
Assembly**

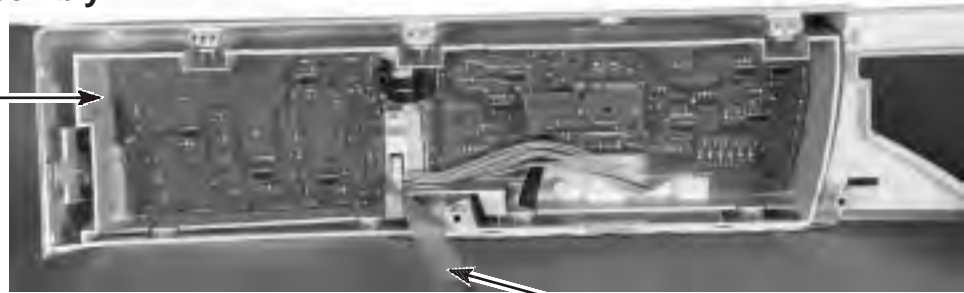

*Fig. 3-10*

**Ribbon Cable**

The Touch Pad/LED Assembly, (*Fig. 3-10*), is removed as a single assembly and is connected to the Central Control Unit by a ribbon cable. This assembly contains all of the buttons, LEDs and ribbon cable and printed circuit boards for the user to operate the washer. This interfaces the consumer inputs to the Central Control Unit.

## Central Control Unit (CCU)

The Central Control Unit is located at the top rear of the washer and is enclosed in a control box. (*Fig. 3-11*) There are no serviceable parts inside the control box. If diagnostic tests indicate any component of the CCU is defective, the entire control box must be replaced.

The CCU receives input from the touchpad/LED assembly and directly controls the dispenser, drain pump, water inlet valves, door locking and unlocking solenoids, and heating element relay. The CCU monitors the pressure switch, flowmeter, temperature sensor and door lock switches.

The CCU sends the customer selection input to the Motor Control Unit for proper motor operation.



*Fig. 3-11*

## Motor Control Unit (MCU)

The Motor Control Unit is located inside a plastic control box located in the lower front corner of the washer cabinet. (*Fig. 3-12*) The control box is shown with the access door open.

The MCU operates the drive motor at varying speeds and direction based on inputs received by the CCU to complete the cycle selected. The MCU also monitors a tachometer on the motor to confirm that the drive motor is operating at the proper speed and direction.

*Fig. 3-12*



## Drive Motor

The drive motor (*Fig. 3-13*) is a three-phase asynchronous induction type that operates at various speeds and direction based on input voltages and frequencies. A tachometer on the motor shaft sends a feedback signal to the Motor Control Unit indicating the rotation speed and direction.

*Fig. 3-13*



## Pump Motor

A separate pump/pump motor is used to drain the wash tub. (Fig. 3-14) The pump motor is 120 VAC and is attached directly to the pump. The pump has a cleanout filter located at the front that allows for the removal of large objects that may have passed from the basket. (Fig. 3-15)

**Drain Pump**

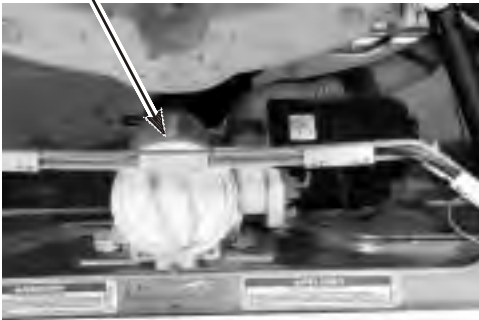

Fig. 3-14

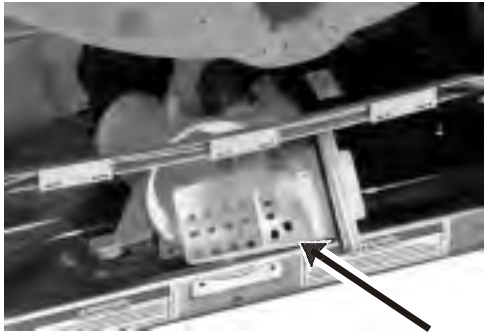
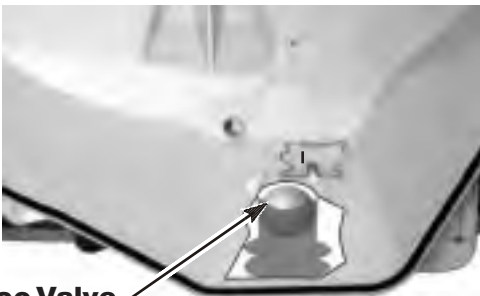

Fig. 3-15

**Large Object Filter**

## Eco Valve

The washer has a specially designed floating valve that closes during the wash portion of the cycle so that 100% of the water and detergent mixture is used on the wash load. The Eco Valve insures that no water or detergent is wasted. (Fig. 3-16 - Shown from Inside Tub)



**Eco Valve**

Fig. 3-16

## Suspension System

The wash tub is held in position with four shock absorbers attached to the bottom four corners of the tub assembly. In addition, the wash tub is suspended from the top frame of the washer with two springs attached to the sides of the unit.

Stability for this suspension system is provided by three concrete counter weights. Two are located at the front of the wash tub. One is positioned at the back of the tub. These counter weights eliminate the need for the traditional balance ring. (Fig. 3-17)

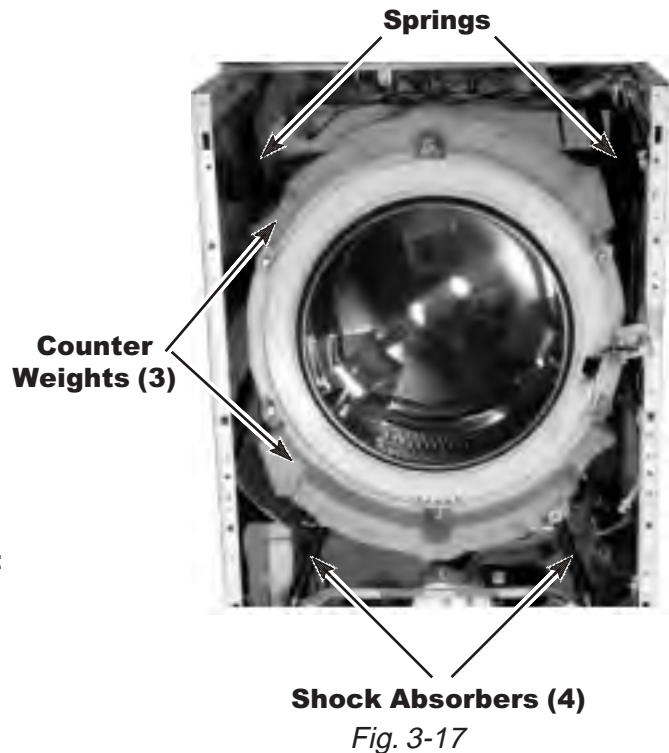

**Shock Absorbers (4)**

Fig. 3-17

## Heating Element and Temperature Sensor

Model GHW9200L provides a heating element to increase the water temperature during certain wash cycles. The temperature sensor is used with the heater to monitor water temperature in the tub. (Fig. 3-18)

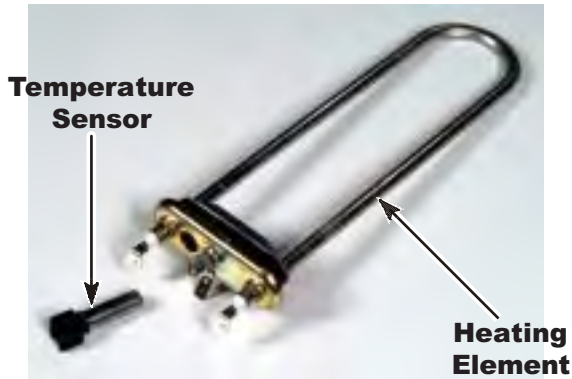

Fig. 3-18

## Door Lock/Switch Assembly

The Door Lock/Switch Assembly is located on the right side of the door opening. (Fig. 3-19 & 3-20) The assembly contains a solenoid operated latching mechanism that will electrically lock the door during a wash cycle.



Fig. 3-19



Fig. 3-20

## Heating Element Relay

A relay is used to turn the heating element on and off. The heating element relay is located in the lower right-hand side of the washer cabinet. (Fig. 3-21) The CCU operates a solenoid to close the main relay contacts, providing 120 VAC to the heating element.

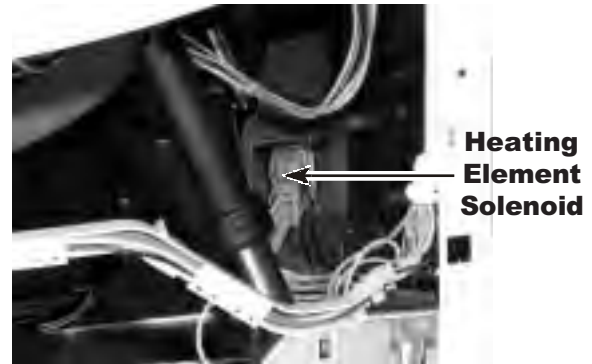

Fig. 3-21

## Panel Interlock Switches

The front and rear interlock switches (Fig. 3-22) are located immediately behind the toe and rear panels of the washer. The switches provide a grounding circuit to the drive motor and heating element, (GHW9200L), when either panel is removed for servicing.

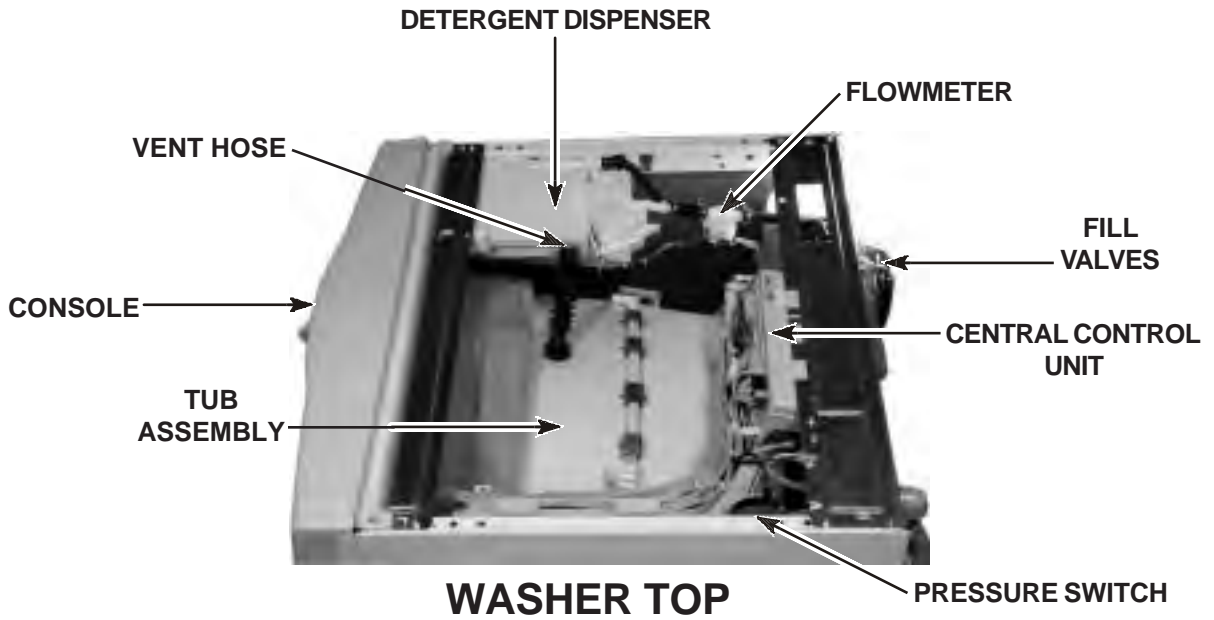

Fig. 3-22

**-- NOTES --**

# COMPONENT ACCESS

## COMPONENT LOCATION



### WASHER BACK

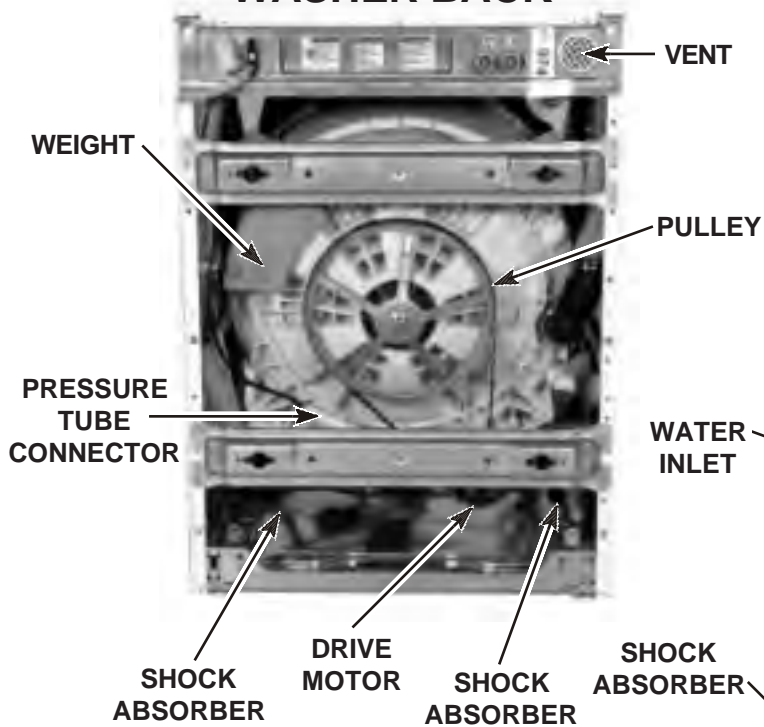

### WASHER FRONT

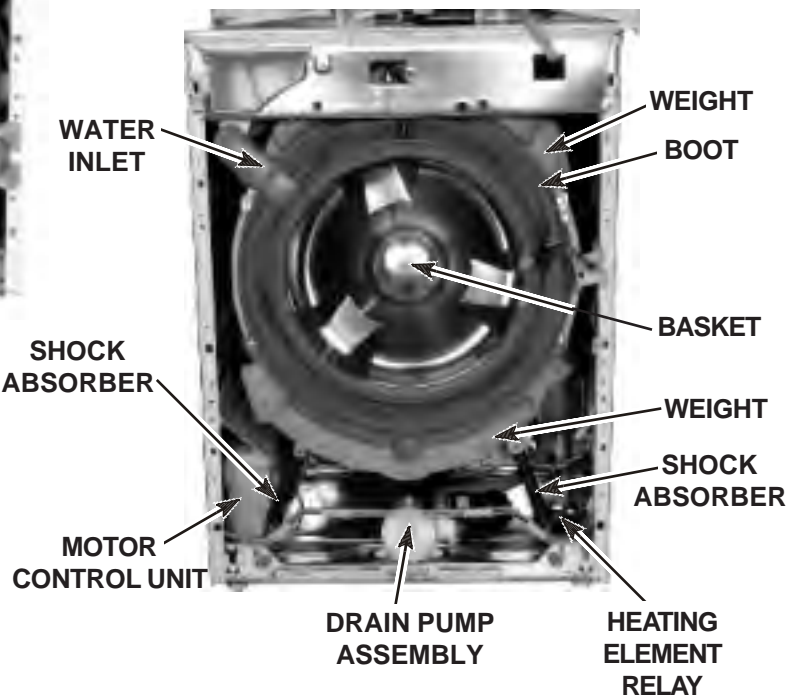

# COMPONENT ACCESS

## Required Tools

The Front-Loading Automatic Washer requires the use of Metric Sockets of various sizes, Torx T-20 and T-25 Drivers, a Crescent Wrench, a flat bladed screwdriver and a hammer.

## ACCESSING COMPONENTS IN THE CONSOLE

Components accessible in the Console include the Console Cover and the Touch Pad/LED Assembly. Access to these components requires that the top of the washer be removed.

### Removing the Washer Top

Three screws secure the washer top at the back of the washer. Remove the three screws and lift the top from the washer. (Fig. 4-4)

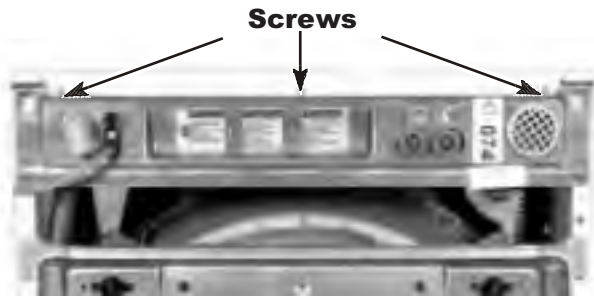

Fig. 4-4

### Removing the Console from the Cabinet

Disconnect the Touch Pad/LED Assembly ribbon connector from the left side of the Central Control Unit (Fig. 4-5) and release it from the wiring harness brackets on the right side of the washer top.

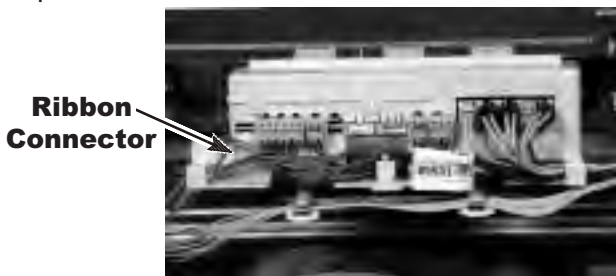

Fig. 4-5

Remove the detergent dispenser drawer by pressing down on the release tab at the back of the drawer (Fig. 4-6A) and pulling it completely out of the washer.

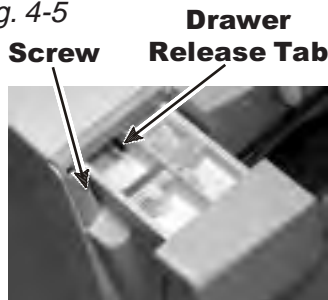

Fig. 4-6A

Once the drawer is removed, remove the screw in the recessed hole next to the drawer opening. Release the tab securing the right side of the console to the washer (Fig. 4-6B).

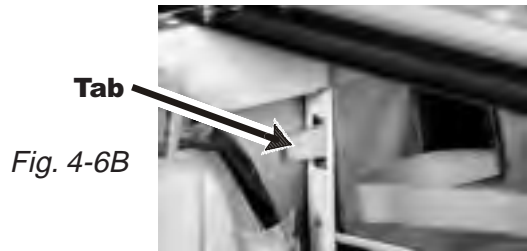

Fig. 4-6B

Open the washer door and place a flat-bladed screwdriver into the slot in the bottom center of the console (Fig. 4-6C). Push the console up to release center console tab. Be sure the ribbon cable clears the cabinet frame.

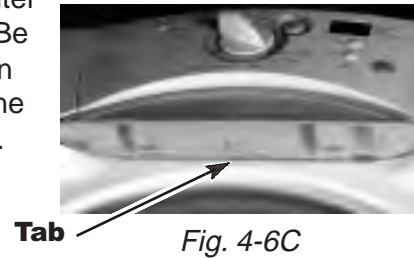

Fig. 4-6C

### Removing the Touch Pad/LED Assembly from the Console

The Touch Pad/LED Assembly is removed as a single unit and contains the Push Buttons, LEDs, cable, etc. (Fig. 4-7A) The buttons can be replaced separately as shown in Fig. 4-7B.

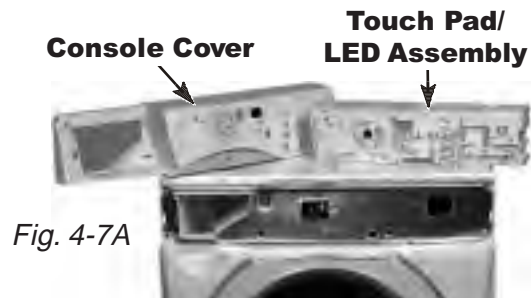

Fig. 4-7A



Fig. 4-7B

Begin by removing the cycle selector knob. There are eight tabs securing the Touch Pad/LED Assembly to the console. (Fig. 4-8) A flat bladed screwdriver will be helpful in releasing these tabs.

**Typical Release Tab**

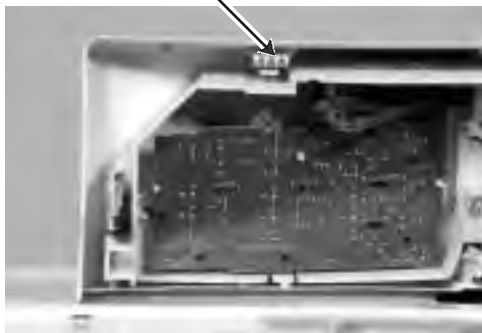

Fig. 4-8

Release these tabs in sequence from left to right around the Touch Pad/LED Assembly until all of the tabs are free and the Assembly can be lifted from the console. (Fig. 4-9)

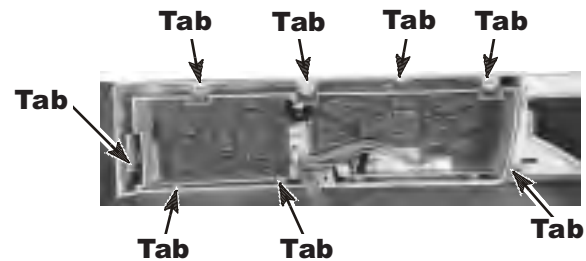

Fig. 4-9

**REMOVING THE WASHER DOOR AND DOOR SWITCH**

The washer door can be removed by removing the upper left shield cover and hinge cover. Open the door and remove three screws securing the door hinge to the washer front and lifting upward.

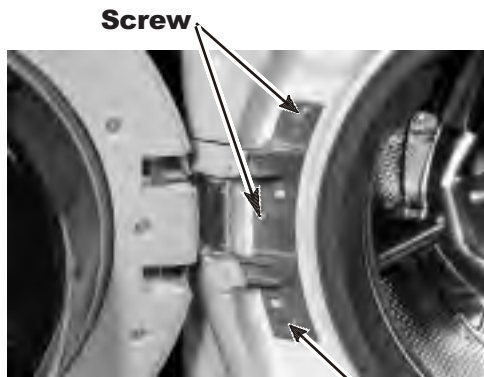

Fig. 4-10

Ease the edge of the boot off of the lip of the washer front near the door switch. (Fig. 4-12) Remove enough of the boot to gain access to the door switch behind the washer front panel.



Fig. 4-12

Access to the door switch requires that the water seal boot be removed from the front of the washer. (Fig. 4-11) Use a flat bladed screwdriver at the location of the retainer spring and pull the retainer forward and then off the perimeter of the boot.



Fig. 4-11

The door switch is secured to the washer front panel with three screws. Once these screws are removed, the door switch will remain in place until it is lifted slightly and pulled back from the washer front panel.



Fig. 4-13

## REMOVING THE WASHER FRONT PANEL

Removing the washer front panel will require that the door switch be removed and the boot be separated completely from the front panel opening. The console must also be removed.

Next, remove the three screws securing the toe panel to the front of the washer (Fig. 4-14) and remove the toe panel by lifting slightly and pulling forward.



**Screws**  
Fig. 4-14

Remove the two screws securing the bottom of the front panel to the washer, and the two screws securing the top of the front panel to the washer. The front panel can now be removed from the washer. (Fig. 4-15)



**Screws**  
Fig. 4-15

## REMOVING THE BOOT FROM THE TUB ASSEMBLY

The boot can be completely removed from the outer rim of the tub assembly.

Carefully pull the boot from around the water inlet and window washer tubes. Remove the boot retainer clamp by loosening the clamp screw located at the upper right of the tub opening. The boot can now be removed from the tub.

### REPLACING THE BOOT AND DOOR SWITCH

When replacing the boot and washer front panel, special care must be taken to assure a proper water seal and operation.

Carefully pull the nozzle from the window washer tube. Separate the plastic gasket ring from the nozzle. Insert the nozzle through the hole in the boot and slide the plastic gasket ring down the shaft of the nozzle so that the boot is securely trapped between the gasket ring and the nozzle ridge. Insert the nozzle shaft into the window washer inlet tube and insert the end of the water inlet tube into the boot.

Fit the boot around the front lip of the tub so it rests smoothly and evenly. Fit the boot clamp around the front lip of the tub and tighten the screw. Be careful not to over tighten this screw. Damage to the boot clamp or the boot could occur.

When reinstalling the door switch, be sure to insert the two tabs on the right side of the switch assembly into the slots in the plastic wiring harness guide. Failure to do this will result in unwanted noise while the machine operates.



## REMOVING THE DETERGENT DISPENSER ASSEMBLY

The Detergent Dispenser Assembly is located under the washer top. Begin by removing the washer top, console and front panel.

Separate the water inlet and window washer tube from the boot.

Pull the water inlet tube from the outlet connector of the detergent dispenser. (Fig. 4-16)

**NOTE:** When reinstalling the water inlet tube, wet the water inlet gasket on the detergent dispenser with water only. Do not use any other lubricant. Align the locator nib on the water inlet tube with the indentation on the dispenser connector and slide the tube onto the detergent dispenser assembly.

Remove the screw securing the front of the detergent dispenser assembly to the top front frame member. (Fig. 4-16)

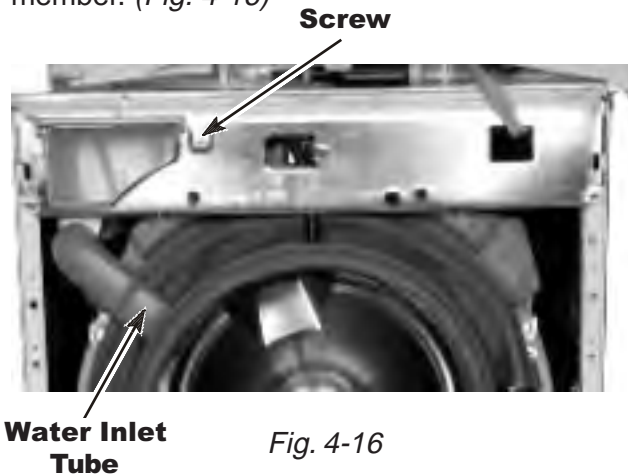

Fig. 4-16

Disconnect the vent tube from the detergent dispenser assembly. (Fig. 4-17)

Remove the screw securing the detergent dispenser assembly to the top left frame member. (Fig. 4-17) Slide the assembly back slightly and lift the assembly out.

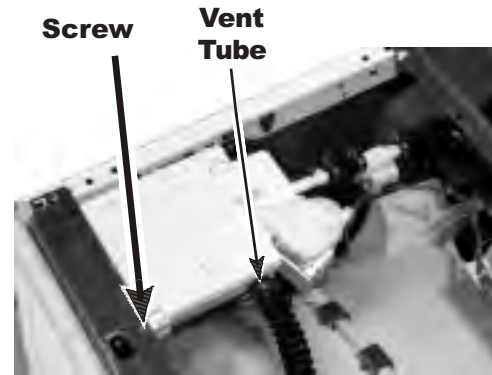

Fig. 4-17

To remove the detergent dispenser motor assembly, disconnect the cam follower spring and lift the cam follower from the diverter cam and rotate the diverter cam clockwise to access the motor mounting screws.

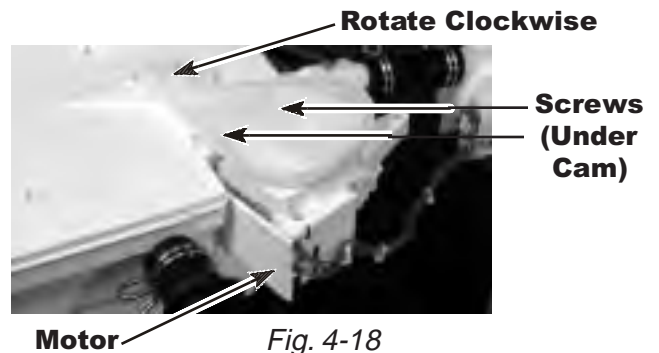

Fig. 4-18

## REMOVING THE CENTRAL CONTROL UNIT AND PRESSURE SWITCH

The Central Control Unit is a single assembly and does not contain any serviceable parts. It can be removed by lifting the top plastic tabs securing it to the back cabinet frame and sliding it towards the front of the washer. (Fig. 4-19)

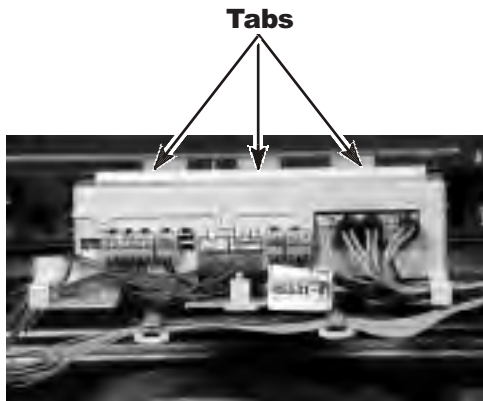

Fig. 4-19

To remove the pressure switch, first remove the wiring harness retainer from the side of the cabinet. (Fig. 4-20)

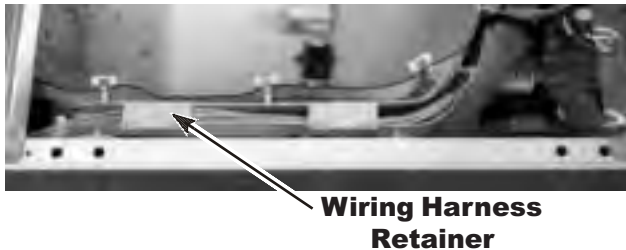

Fig. 4-20

Then disconnect the wiring harness connectors and the pressure hose and turn the pressure switch counterclockwise to release it from the cabinet. (Fig. 4-21)

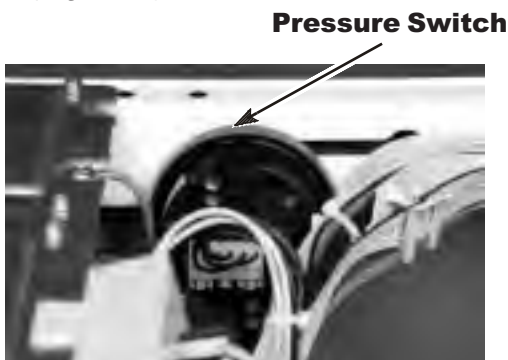

Fig. 4-21

## REMOVING THE DRIVE MOTOR

The drive motor can be removed once the back panel has been removed.

Twelve screws secure the back panel to the washer. Remove the 12 screws and remove the back panel. Remove the Drive Belt.

Disconnect the wiring harness connectors and ground wires from the drive motor terminals. Push the wiring harness tie from the motor mounting bracket.

Remove the mounting bolt securing the motor to the tub. (Fig. 4-22)

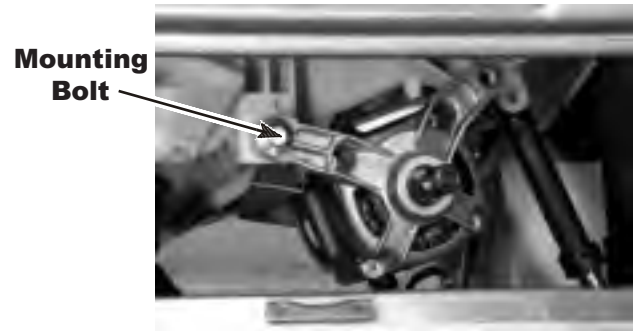

Fig. 4-22

## REMOVING THE PUMP ASSEMBLY

The pump assembly can be accessed once the toe panel has been removed.

To remove the pump assembly, begin by opening the door covering the wiring harness connector and disconnect the wiring harness from the pump motor terminals. Remove the screw securing the pump assembly to the washer frame. (Fig. 4-23) Once the pump is removed the drain hose and tub outlet hose can be removed.

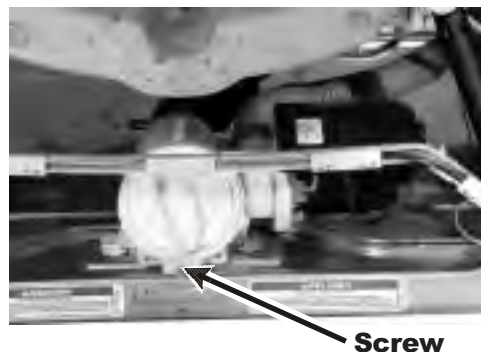

Fig. 4-23

To clean out the large item filter, turn the large knob counterclockwise and pull it out. (Fig. 4-24)

**NOTE:** It is recommended that a small pan be placed under the pump prior to removing the large item filter. There will be water in the pump housing.



Fig. 4-24

## REMOVING THE SHOCK ABSORBERS

The tub is held in position by four shock absorbers, two in front (Fig. 4-25) and two at the back. Each shock absorber can be disconnected from the tub by turning the top of the shock mount counter clockwise, 90°. The shock can be removed from the washer by turning the bottom shock mount counterclockwise, 90°.

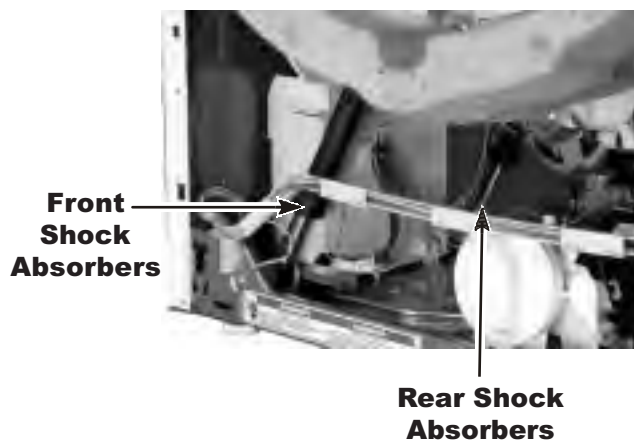

Fig. 4-25

## ACCESSING THE MOTOR CONTROL UNIT

Access to the Motor Control Unit may require removing the left front shock absorber. Separate the taped flap of the top of the MCU to the cabinet.

Using a flat bladed screwdriver, lift up on the plastic tab under the front right corner of the motor controller box. (Fig. 4-26 - INSET)



Fig. 4-26

**Place Blade of Screwdriver Here**



Fig. 4-27

Slide the box forward to release the two tabs at the back of the box from the bottom panel of the washer. (Fig. 4-27)

Open the door on the control box to access to the test points of the Motor Control Unit. (Fig. 4-28)



Fig. 4-28

## REMOVING THE HEATING ELEMENT AND TEMPERATURE SENSOR

Disconnect the wiring harness connectors from the heating element terminals and loosen but do not remove the 10-millimeter nut between the heating element terminals. (Fig. 4-29) Then slide the heating element from the tub. Slide the temperature sensor from the heating element bracket.

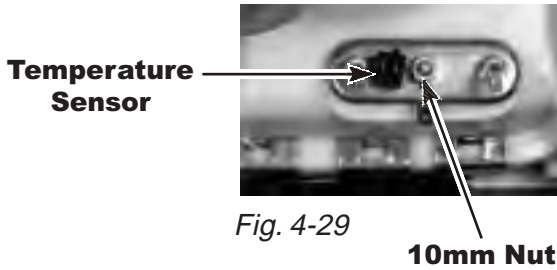

## REMOVING THE HEATING ELEMENT RELAY

Disconnect the wiring harness connectors from the relay terminals. Rotate the relay 90° counter-clockwise to release the relay from the washer base. (Fig. 4-30)

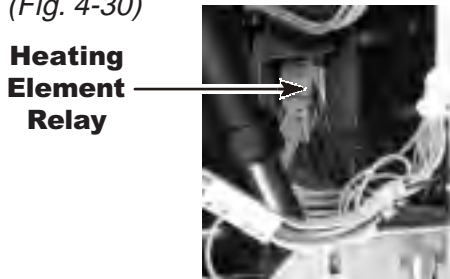

## REMOVING THE TUB AND BASKET ASSEMBLY

There are three concrete weights attached to the tub assembly. All three must be removed for safe removal of the tub assembly.

Access to the weight on the top front of the tub requires removing the six screws securing the top front frame member from the washer and removing the frame member. (Fig. 4-31A)

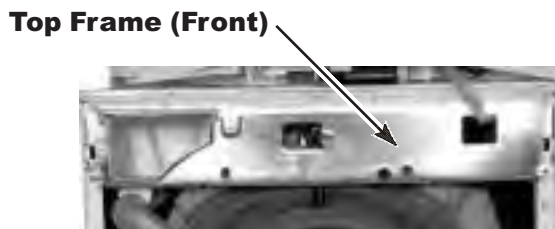

Access to the weight on the top back of the tub requires removing the two screws securing the upper transport brace to the washer and removing the brace. (Fig. 4-31B)

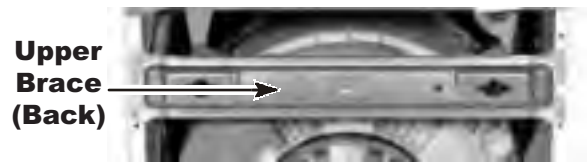

Each weight is secured to the tub by three 13-millimeter bolts. (Fig. 4-32) Remove the three bolts and lift the weight from the tub.

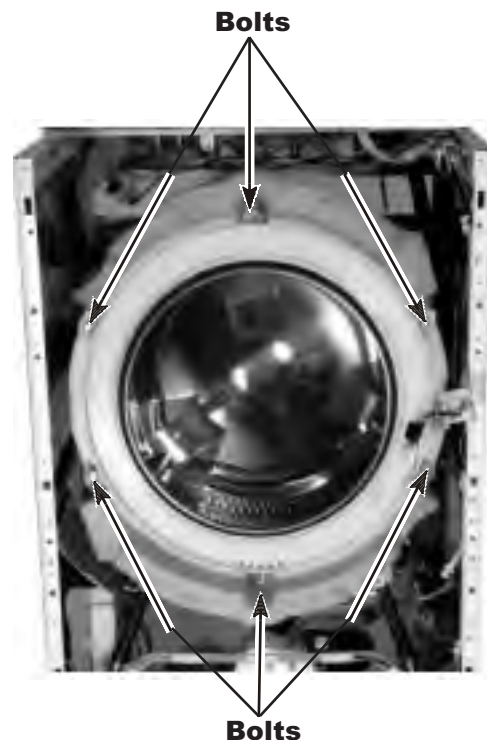

Remove the flat nuts from the tub for safekeeping. (Fig. 4-33)

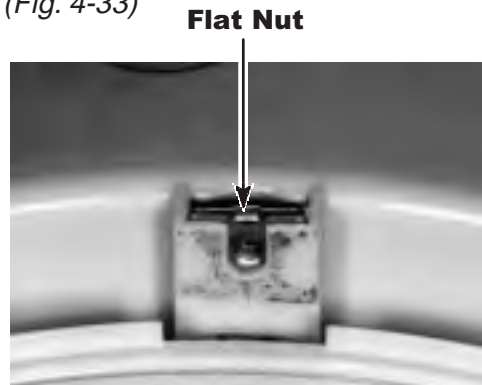

At the back of the tub assembly, remove the belt from the basket and motor pulleys. (Fig. 4-34 -1)

To remove the pulley from the basket, place the handle of a crescent wrench through the pulley and into the steel bearing hub to keep the pulley from turning. (Fig. 4-34-2)

Use a 21-millimeter socket wrench to remove the nut securing the pulley to the basket. (Fig. 4-34 -3)

Disconnect the ground wire from the bearing hub with a T-25 Torx driver. (Fig. 4-34 -4)

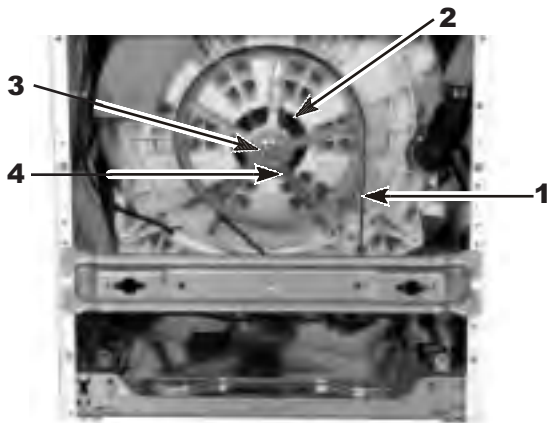
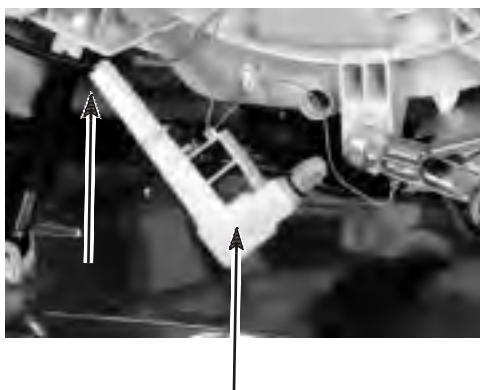

Fig. 4-34

Remove the screw securing the left end of the pressure tube connector to the tub. Then, press down on the plastic tab securing the right end of the pressure tube connector and pull it from the tub. (Fig. 4-35)



**Pressure Tube Connector  
Removed**

Fig. 4-35

Disconnect the vent hose and outlet hose from the tub.

The tub is held in position by four shock absorbers, two in front and two at the back. (Fig. 4-36) Each shock absorber can be disconnected from the tub by turning the top of the shock mount counter clockwise, 90°. The shock can be removed from the washer by turning the bottom shock mount counterclockwise, 90°.

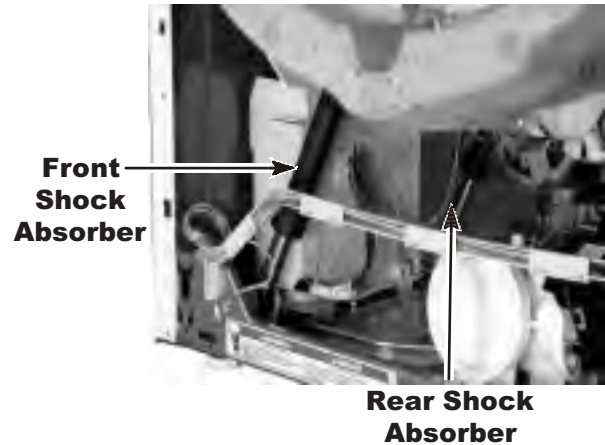

Fig. 4-36

Remove the top end of the suspension springs from the hanger slot in the top cabinet frame. To release the spring at the right side of the cabinet, it may be necessary to remove the wiring harness retainer from the cabinet.

Once the final spring is released the tub is free to be removed from the washer cabinet. (Fig. 4-37)

**NOTE:** Take care not to let the tub drop free inside the cabinet. This could result in damage to components in the cabinet or damage to the tub assembly.



Fig. 4-37

The two piece tub is held together with a number of metal clamps which can be removed by prying them off with a flat bladed screwdriver. (Fig. 4-38)



Fig. 4-38

The tub can now be separated and the basket can be pulled from the back half of the tub. (Fig. 4-39)

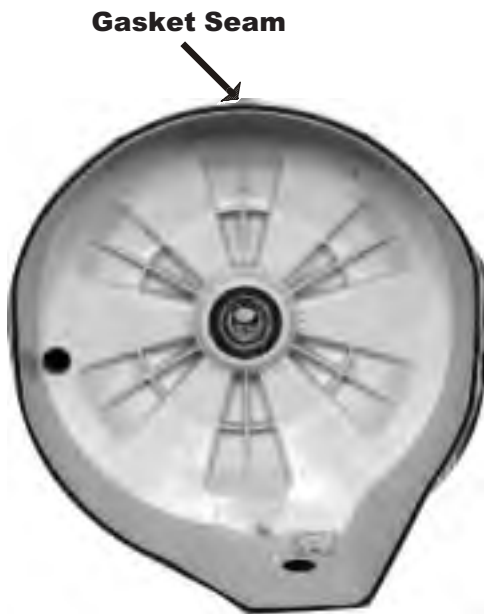

Fig. 4-39

The gasket seam is located at the top of the tub to minimize the possibility of a water leak.

## REASSEMBLING AND REINSTALLING THE TUB ASSEMBLY

When reassembling and reinstalling the tub assembly, take note of these special procedures.

1. When reassembling the tub, be sure to install all the metal clips all around the tub. A hammer may be necessary to do this.
2. When reinstalling the heater element, be sure it is inserted properly in the retainer inside the tub. (Fig. 4-40)

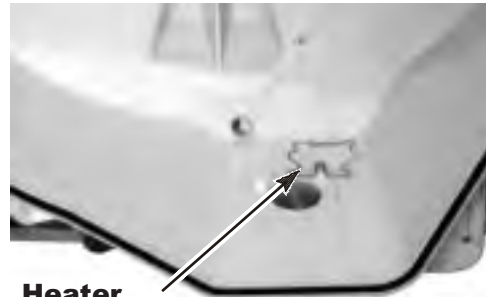

Heater Retainer

Fig. 4-40

3. When reinstalling the tub, be sure to hook the springs into the holes towards the front of the tub as well as the front of the cabinet.
4. A small piece of duct tape may be necessary to hold the flat nut in place when replacing the front bottom concrete weight. (Fig. 4-41)

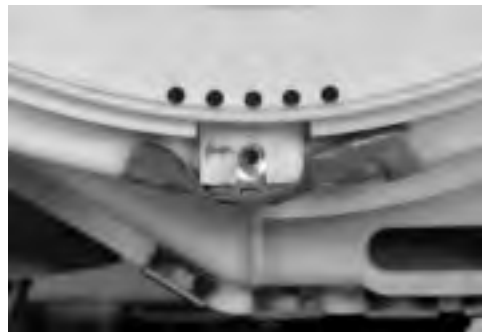
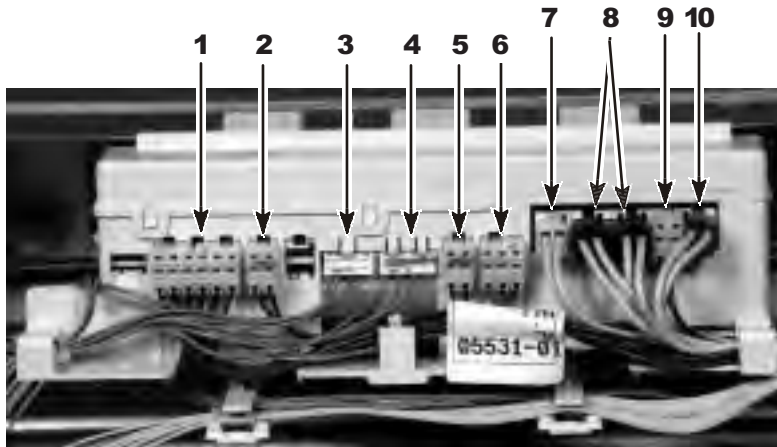

Fig. 4-41

# COMPONENT TESTING

## CENTRAL CONTROL UNIT

### Connector Location



- |                                  |                                    |
|----------------------------------|------------------------------------|
| <b>1. Pressure Switch</b>        | <b>6. Door Lock Solenoids</b>      |
| <b>2. Temperature Sensor</b>     | <b>7. Motor Control Unit Power</b> |
| <b>3. Dispenser Switch/Motor</b> | <b>8. Door Lock Main Switches</b>  |
| <b>4. Inlet Valves</b>           | <b>9. Heating Element Relay</b>    |
| <b>5. Drain Pump</b>             | <b>10. Line Filter</b>             |

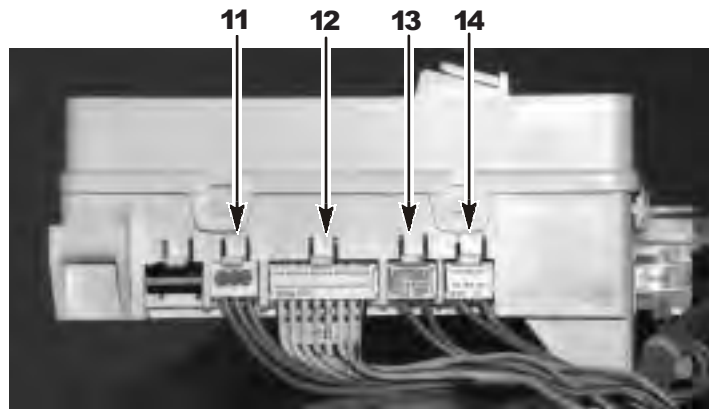

- 11. Serial Comm Link**
- 12. Touchpad/LED Ribbon Cable**
- 13. Door Switch**
- 14. Flowmeter**

# ! WARNING



## ELECTRICAL SHOCK HAZARD

Disconnect power before servicing.

Replace all panels before operating.

Failure to do so can result in death or electrical shock.

## COMPONENT CHECKS

Continuity checks can be made on various components of the washer from the connectors on the Central Control Unit. Before performing any of these tests, disconnect the washer from the wall outlet. In addition, disconnect the wiring harness connector from the Central Control Unit before making any continuity tests.

### Pressure Switch

The pressure switch can be checked at various water levels. Disconnect the pressure switch connector from the control box.



Water Level	Test Points	Reading
Empty	4 to 6	0 ohms
Suds Detect	1 to 2	0 ohms
L1	4 to 5	0 ohms
Overflow	3 to 4	0 ohms

### Temperature Sensor



Temperature	Results
32° F (0° C)	35.9K $\Omega$
86° F (30° C)	9.7K $\Omega$
104° F (40° C)	6.6K $\Omega$
122° F (50° C)	4.6K $\Omega$
140° F (60° C)	3.2K $\Omega$
158° F (70° C)	2.3K $\Omega$
203° F (95° C)	1K $\Omega$

### Dispenser Switch and Motor

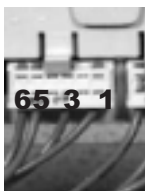

	Test Points	Reading
Switch	6 to 5	0 ohms
Motor	3 to 1	1400 ohms



## Water Inlet Solenoids



Hot Water Solenoid  
Cold Water Solenoid

### Test Points

7 to 5  
3 to 1

### Reading

800 ohms  
800 ohms

## Drain Pump Motor



### Test Points

2 to 1

### Reading

15 ohms

## Door Lock/Unlock Solenoids

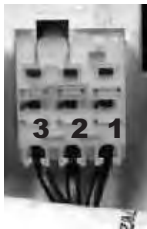

Unlock Solenoid  
Lock Solenoid

### Test Points

3 to 2  
3 to 1

### Reading

60 ohms  
60 ohms

## Door Lock Main Switches

To check the door lock main switches, the door must be locked. Begin by selecting a cycle and press START. You will hear the door lock solenoid engage. Unplug the washer from the wall outlet and check for continuity at the following points.

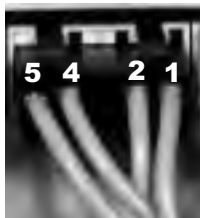

Main Switch 1  
Main Switch 2

### Test Points

5 to 4  
2 to 1

### Reading

0 ohms  
0 ohms

## Heating Element Relay Solenoid



**Test Points**  
2 to 1

**Reading**  
15 ohms

## Door Switch



**Door Closed**  
**Door Open**

**Test Points**  
2 to 1  
2 to 1

**Reading**  
0 ohms  
Infinity

## MOTOR CONTROL UNIT

### Connector Location

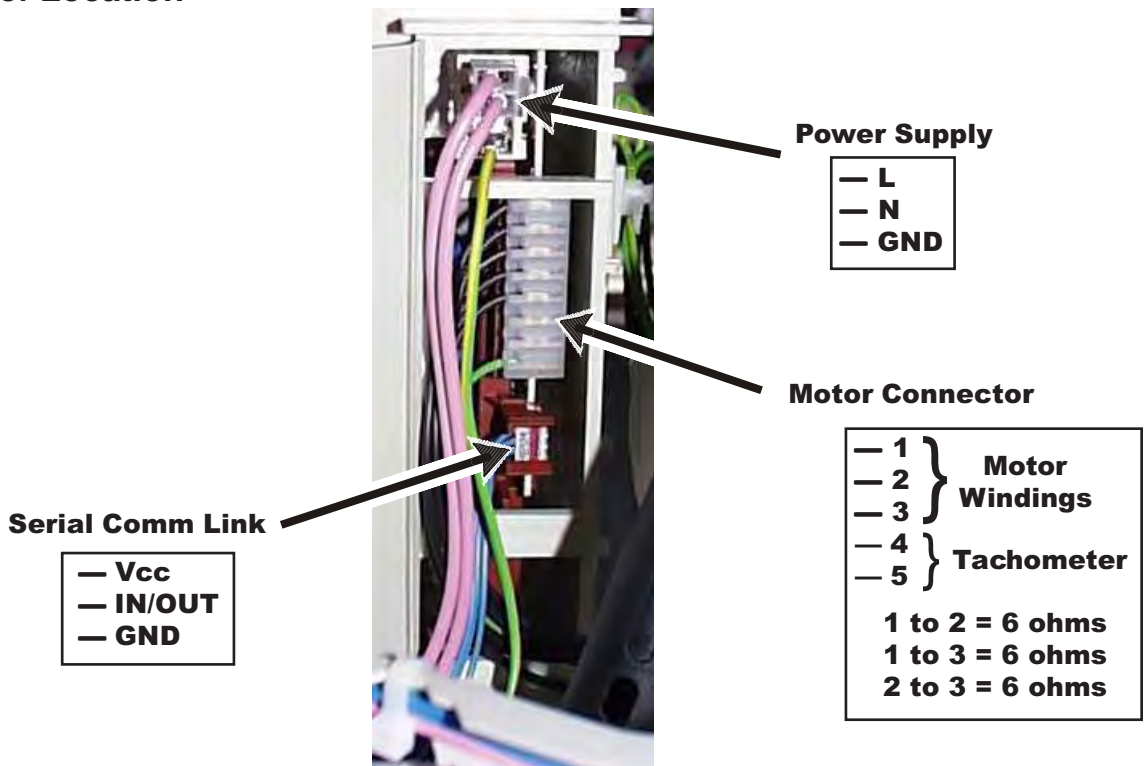

## LINE FILTER

### Test Points

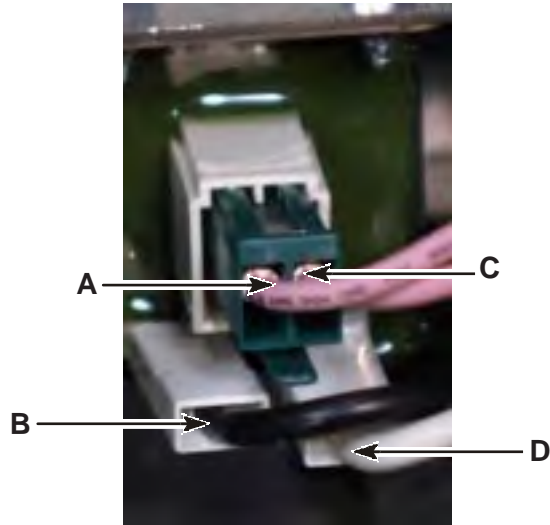

A to B = 0 ohms  
C to D = 0 ohms

## DISPENSER

### Connector Location

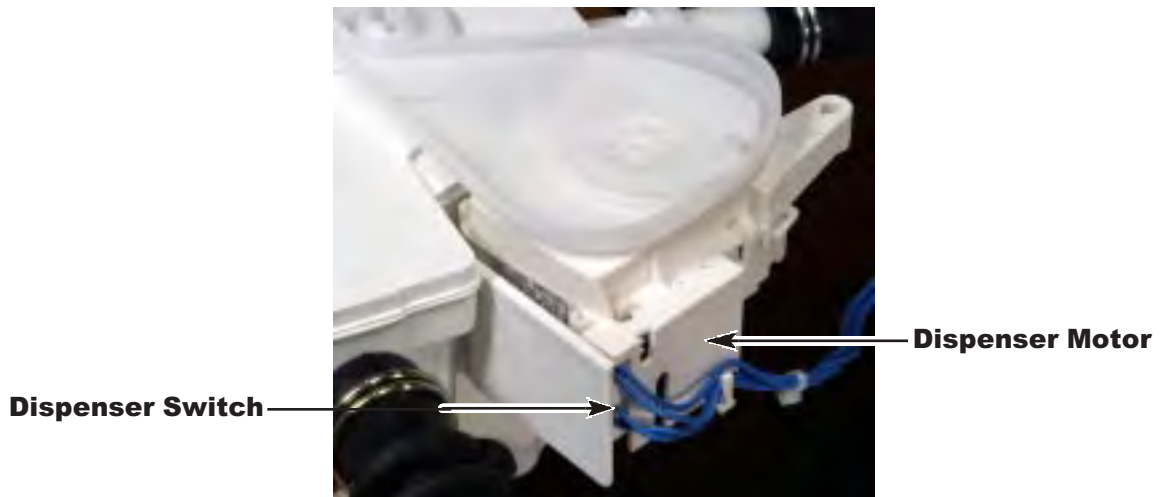

Dispenser Motor Continuity Check - 1400  $\Omega$

# PRESSURE SWITCH

## Connector Location



22 24 21 26 11 14 Blank

### Water Level

- Empty
- Suds Detect
- Level 1
- Overflow

### Contacts Made

- 21 to 22
- 11 to 14
- 21 to 24
- 21 to 26

# HEATING ELEMENT and TEMPERATURE SENSOR

## Connector Location

### Heating Element Terminals

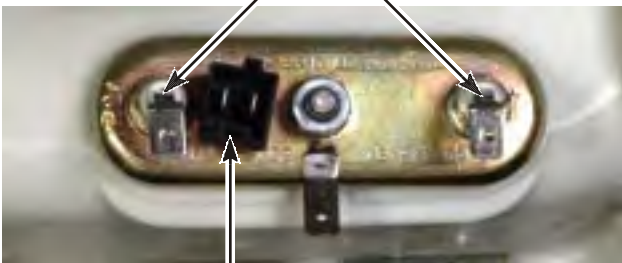

### Temperature Sensor Terminals

## Heating Element

Test Points	Reading
Between Terminals	15 ohms

## Temperature Sensor

Temperature	Results
32° F (0° C)	35.9K $\Omega$
86° F (30° C)	9.7K $\Omega$
104° F (40° C)	6.6K $\Omega$
122° F (50° C)	4.6K $\Omega$
140° F (60° C)	3.2K $\Omega$
158° F (70° C)	2.3K $\Omega$
203° F (95° C)	1K $\Omega$

# HEATING ELEMENT RELAY SOLENOID



A to B = 15 ohms

# DIAGNOSIS & TROUBLESHOOTING

## SUDS DETECTION

### During Drain Routine

During the Drain Routine, the water level is checked continuously. Normal drain will occur until the pressure switch senses no water in the wash tub and there is no foam (suds). The drain pump will operate an additional 15 seconds after the pressure switch reports no water or foam.

If the drain routine operates for four (4) minutes and the pressure switch senses any foam (suds) in the wash tub, the Central Control Unit will start the "Kill-Foam" Routine. (See description of this Routine below.) After the Kill-foam Routine is concluded, the Drain Routine will restart. If, after four (4) minutes the pressure switch still senses foam in the wash tub, the Central Control Unit will go into Failure Mode. The digital display will show, F02.

### During Spin (Extract) Routine

During the Spin/Extract Routine the water level is checked continuously. If, during this routine, the pressure switch senses the presence of foam (suds) in the wash tub, the Central Control Unit will stop the drive motor and the basket will stop spinning. The electronic control will count the number of spin repetitions that are attempted due to foam (suds). There are a maximum of three (3) attempts for each Spin/Extract Routine.

### Kill-Foam Routine

1. The Remaining Time counter is stopped.
2. The digital display shows Sud.
3. The Drain Pump is turned OFF.
4. The Central Control Unit will fill the wash tub with 1 gal. (4 L) of cold water.
5. While the tub is filling the basket will tumble 1 sec. ON/15 Sec. OFF.
6. Once the tub is filled, the drive motor will turn OFF and the basket will rest without any movement for five (5) minutes.
7. After the five (5) minute rest, the remaining time counter will restart and the digital display will show the remaining time left in the routine.

**NOTE:** If the Kill-Foam routine was initiated during a Spin/Extract Routine, the tumbling action will be reduced to a cycle of 3 sec. ON/13 sec. OFF. If, at the end of either the Drain or Spin/Extract Routines, a suds condition still remains, the digital display will show Sud. Sud will also be displayed for a short period at the end of a cycle, if a Suds condition was detected during the cycle. This will alert the consumer to reduce the amount of detergent in subsequent uses.

# DOOR LOCKING AND UNLOCKING

## Locking

The Door Locking Routine will only start if the door is securely closed and the Door Switch Contact is CLOSED.

1. The Door Lock Relay is energized whenever a wash cycle is started. The relay is operated for 40 milliseconds.
2. During the next three (3) seconds, the contacts on the door lock are checked by the central control unit
  - a. If the contacts are CLOSED, this routine is finished.
  - b. If the contacts are still open after 3 seconds, the Central Control Unit energizes the Door Lock Relay for 40 ms and then checks the door lock contacts for 3 seconds. This will occur a maximum of 6 times. If the door is not locked after 6 trials, the Central Control Unit will enter a failure mode and the digital display will show FdL.

## Unlocking

**Unlocking will occur only under the following conditions:**

1. The drive motor speed equals 0 or the time since the drive motor STOP command has been sent to the Motor Control Unit is greater than 180 seconds.
2. The time since the inlet valve was CLOSED is greater than five (5) seconds.
3. If the temperature of the water is greater than 122°F (50° C), the water will be drained before unlocking will occur.
4. If the water level is higher than the wash level in the Delicate, Wool or Handwash cycles, the water will be drained before unlocking will occur.

**The Unlocking Routine is:**

1. The Door Unlock Relay is energized for 40 ms.
2. During the next three (3) seconds, the contacts of the Door Lock are checked. If the contacts are OPEN, the Unlocking Routine is finished.
3. If the contacts are still CLOSED after three (3) seconds, the Central Control Unit energizes the Door Unlock Relay for 40 ms. and then check the door lock contacts for three (3) seconds. If the door is not unlocked after 6 trials, the Central Control Unit will enter a failure mode and the digital display will show FdU.

## Child Security Routine

The Child Security Routine is initiated at the start of any wash cycle.

1. The Door is Locked.
2. The tub fills with Cold water for three (3) seconds.
3. The door is Unlocked for five (5) seconds.
4. The door is Locked and the wash cycle begins.

## Unbalance Detection Routine

The unbalance detection routine occurs during the distribution ramp (while basket spin is accelerating from 40 to 400 rpm). At 400 rpm the motor is decelerated and the rate of deceleration is monitored by the CCU. The motor is then ramped up to 400 rpm and shut off. The rate of deceleration is monitored again and compared to the first deceleration rate. Based on this comparison, the CCU can determine whether an unbalanced condition exists or not.

- a. If the Motor Control Unit does not sense an unbalanced condition, the ramp will continue.
- b. If the Motor Control Unit senses an unbalanced condition, the drive motor is stopped.

## ERROR CODES

DISPLAY	EXPLANATION AND RECOMMENDED PROCEDURE
<b>F/H</b>	<p><b>No water detected entering machine or Pressure switch trip not detected.</b></p> <p>If after 30 seconds the control does not detect water entering machine and then valves will be turned off and the error code will be displayed.</p> <p>Or</p> <p>If the control has turned the water valves on and after 8 minutes the flow meter has detected 10.5 gallons of water passing through it, but has not detected the pressure switch trip, the valves will be turned off and the error code will flash.</p> <p><b>Press PAUSE/CANCEL twice to clear the display.</b></p> <p><b>Potential Causes</b></p> <ul style="list-style-type: none"> <li>• If there is no water in the unit: <ul style="list-style-type: none"> <li>• Make sure that both valves at the water source(s) are turned on all the way.</li> <li>• Check for plugged or kinked inlet hoses or plugged screens in the inlet valves</li> <li>• Verify inlet valve operation</li> </ul> </li> <li>• If there is water in the unit: <ul style="list-style-type: none"> <li>• Verify Drain pump operation</li> <li>• Pressure Switch Hose is in good condition and properly connected to Tub and Pressure switch</li> </ul> </li> <li>• Verify there is not a siphon problem</li> <li>• Verify wire harness connections to; Inlet Valves, Pressure Switch, Drain Pump, Flow Meter, and Central Control Unit (CCU)</li> <li>• Check all hoses for possible leaks</li> <li>• Verify pressure switch operation</li> <li>• Verify flow meter operation</li> <li>• Verify CCU operation</li> </ul>
<b>F/02</b>	<p><b>Long Drain</b></p> <p>If the drain time exceeds 8 minutes, the water valves are turned off and “F/02” is flashed.</p> <p><b>Press PAUSE/CANCEL twice to clear the display.</b></p> <p><b>NOTE: After 4 minutes the “Sud” error will be displayed, then 4 minutes later the F/02 error code will be displayed.</b></p> <p><b>Potential Causes</b></p> <ul style="list-style-type: none"> <li>• Check the drain hose and make sure it is not plugged or kinked</li> <li>• Check the electrical connections at the pump and make sure the pump is running.</li> <li>• Check the drain pump filter for foreign objects</li> <li>• If the above does not correct the problem replace the pump</li> </ul>
<b>F/05</b>	<p><b>Water Temperature Sensor Error</b></p> <p>If during the water heating step in the wash cycle, the water temperature sensor (NTC) value is out of range, or the heating element circuit has failed, the “F/05” error code will be displayed.</p> <p><b>Potential Causes</b></p> <ul style="list-style-type: none"> <li>• Check the Water Temperature Sensor, Heating Element and Element Relay</li> <li>• Check connections to the Sensor, Heating Element and Relay</li> </ul>



## ERROR CODES

DISPLAY	EXPLANATION AND RECOMMENDED PROCEDURE
<b>F/06</b>	<p><b>Drive Motor Tachometer Error</b></p> <p>The control is unable to properly detect motor speed and the machine will shut down. If a failure occurs during high-speed spin the door will be unlocked after 3 minutes.</p> <p><b>Potential Causes</b></p> <ul style="list-style-type: none"> <li>• Check wire harness connections between the Drive Motor/Tachometer and the Motor Control Unit (MCU), and between the MCU and the Central Control Unit (CCU)</li> <li>• Check the Drive Motor</li> <li>• Check the MCU</li> <li>• Check the Wire Harness</li> </ul>
<b>F/07</b>	<p><b>Motor Control Unit Error</b></p> <p>The Central Control Unit has detected a short in the motor control unit. If a failure occurs during high-speed spin the door will be unlocked after 3 minutes.</p> <p><b>Potential Causes</b></p> <ul style="list-style-type: none"> <li>• Check wire harness connections between the Drive Motor and the Motor Control Unit (MCU), and between the MCU and the Central Control Unit (CCU)</li> <li>• Check the MCU</li> <li>• Check the Drive Motor</li> <li>• Check the Wire Harness</li> </ul>
<b>F/09</b>	<p><b>Overflow Condition</b></p> <p>If the Overflow contact on the pressure switch is Closed for more than 60 seconds an Overflow condition will occur. In an Overflow condition, the Door will remain locked, and the Drain Pump will run constantly, even if PAUSE/CANCEL is pressed twice and the Display is cleared. Unplug the unit to service.</p> <p><b>Potential Causes</b></p> <ul style="list-style-type: none"> <li>• Check the drain hose and make sure it is not plugged or kinked</li> <li>• Check Wire Harness connections to the Drain Pump, Pressure Switch, and Central Control Unit (CCU)</li> <li>• Check/ Clean Drain Pump Filter of foreign objects</li> <li>• Check for Drain Pump Failure</li> <li>• Check the Inlet Valve for proper shut off</li> <li>• Check the Pressure switch for proper operation</li> </ul>
<b>F/10</b>	<p><b>Motor Control Unit (MCU) Heat Sink Thermal Trip</b></p> <p>If the thermal protector on the MCU heat sink gets too hot, it will open the thermal protector on the heat sink which will stop motor functions and an "F/10" will be displayed.</p> <p><b>Potential Causes</b></p> <ul style="list-style-type: none"> <li>• Check for Proper Installation, verify the unit is not located near a source of heat and has proper ventilation.</li> <li>• Check Wire Harness connections to the MCU, the motor, and Central Control Unit (CCU)</li> <li>• Check the Drive system for any worn or failed components</li> <li>• Check MCU</li> <li>• Check Motor</li> </ul>

## ERROR CODES

DISPLAY	EXPLANATION AND RECOMMENDED PROCEDURE
<b>F/11</b>	<p><b>Serial Communication Error</b></p> <p>Communication between the Central Control Unit (CCU) and the Motor Control Unit (MCU) cannot be sent correctly.</p> <p><b>Potential Causes</b></p> <ul style="list-style-type: none"> <li>• Check Wire Harness connections to the MCU, the motor, and Central Control Unit (CCU)</li> <li>• Check the Drive system for any worn or failed components</li> <li>• Check MCU</li> <li>• Check CCU</li> <li>• Check Motor</li> <li>• Check Wire Harness</li> </ul>
<b>F/13</b>	<p><b>Dispenser Circuit Error</b></p> <p>If the dispenser motor is not able to be driven to it's proper position.</p> <p><b>Potential Causes</b></p> <ul style="list-style-type: none"> <li>• Check mechanical linkage from dispenser motor to the top of the dispenser.</li> <li>• Check Wire Harness connections to the dispenser motor and Central Control Unit (CCU)</li> <li>• Check Dispenser Motor</li> </ul>
<b>F/14</b>	<p><b>EEPROM Error</b></p> <p>The Central Control Unit (CCU) receives it's data from an EEPROM onboard the CCU. If there is an error reading this data it will cause this error.</p> <p><b>Potential Causes</b></p> <ul style="list-style-type: none"> <li>• A power glitch may cause this error. Try unplugging the Unit for two minutes to see if that fixes the error.</li> <li>• Check CCU.</li> </ul>
<b>F/15</b>	<p><b>Motor Control Unit (MCU) Error</b></p> <p>If the MCU detects multiple resets or errors during a wash cycle it will go into this error mode.</p> <p><b>Potential Causes</b></p> <ul style="list-style-type: none"> <li>• Check Wire Harness connections to the MCU, the motor, and Central Control Unit (CCU)</li> <li>• Check Drive belt</li> <li>• Check MCU</li> <li>• Check Motor</li> <li>• Check Wire Harness</li> </ul>
<b>Sud</b>	<p><b>SUDS LOCK (Overdose of Detergent detected during the Wash Cycle)</b></p> <p>The motor control unit senses a suds lock condition by analyzing the current draw on the drive motor. If "Sud" is displayed a potential suds lock is detected. This may signify a bad pump, an extra heavy load, excessive detergent, or excessive suds.</p>

## ERROR CODES

DISPLAY	EXPLANATION AND RECOMMENDED PROCEDURE
	<p><b>Potential Causes</b></p> <ul style="list-style-type: none"> <li>• If too much detergent was used, run the unit through a Rinse/ Spin cycle then a Normal cycle without adding any detergent. This should clear the unit of the excess detergent.</li> <li>• Check the drain hose and make sure it is not plugged or kinked</li> <li>• Check Wire Harness connections to the Drain Pump, Pressure Switch, and Central Control Unit (CCU)</li> <li>• Check/ Clean Drain Pump Filter of foreign objects</li> <li>• Check Drain Pump</li> <li>• Check the Pressure Switch</li> <li>• Check CCU</li> </ul>
<b>F/dL</b>	<p><b>Door Lock Error</b></p> <p>A Door Lock Error occurs if the door cannot be locked. It will try to lock it 6 times before displaying the error.</p> <p><b>Potential Causes</b></p> <ul style="list-style-type: none"> <li>• Door Lock Mechanism broken or removed from the Door</li> <li>• Check Door Lock/Switch Assembly</li> <li>• Check the wire harness connections to the Door Lock/Switch Assembly and Central Control Unit (CCU)</li> <li>• Door Lock/Switch Assembly Failure</li> </ul>
<b>F/dU</b>	<p><b>Door Unlock Error</b></p> <p>A Door Unlock Error occurs if the door cannot be unlocked. It will try to unlock the door 6 times before displaying the error.</p> <p><b>Potential Causes</b></p> <ul style="list-style-type: none"> <li>• Door Lock Mechanism broken.</li> <li>• Check Door Lock/Switch Assembly for foreign objects</li> <li>• Check Wire Harness connections to the Door Lock/Switch Assembly and Central Control Unit (CCU)</li> <li>• Door Lock/Switch Assembly Failure</li> </ul> <p><i>Note:</i> The Door Lock/Switch Assembly can be manually unlocked. See Section Seven, <b>TECH TIPS</b></p>

## DIAGNOSTIC TEST

The control must be in the OFF state before pressing the touch-pad sequence to start the test.

### Starting the test mode

Close the door.

Press the Control On button.

Select the DRAIN/SPIN cycle.

Select NO SPIN by pressing the SPIN SELECT button, as needed.

Push Prewash Option button four (4) times within five (5) seconds. C:00 will show in the display.

**NOTE:** If Model does not have PREWASH Mode as an option, press RINSE/HOLD.

If the Starting procedure fails, push PAUSE/CANCEL button. Then repeat the starting sequence.

### Test Program Control during Execution

To advance to the next step of the test procedure, push Prewash Option button two (2) times.

### Overview Test Program

Indication	Control Action	Actuators to be Checked
C:00	Door is Locked	Door Lock System
C:01	Filling by cold water inlet valve	Flowmeter, Cold water inlet valve
C:02	Distribution system is set to Prewash position	Dispenser motor, Dispenser contact
C:03	Fill by hot water inlet valve	Hot water inlet valve
C:04	Basket rotates clockwise at wash speed	Motor, MCU control
C:05	Heater is switched ON. Basket rotates clockwise with wash speed. If there is not enough water in the tub, the water inlet valve will be switched ON to fill-in the minimum water quantity. <b>NOTE:</b> On GHW 9100 Models only the Temperature Sensor will be checked	Heater, Temperature Sensor
C:06	Drain Pump is ON	Drain Pump
C:07	Basket rotates counterclockwise from 35 to 90 rpm within 15 seconds	Motor, MCU control
C:08	Basket rotates counterclockwise with max. speed Basket speed > 1100 rpm	Motor, MCU control

## Motor Continuity Test

Disconnect the wire harness from the motor and measure the resistance of the motor windings.

Motor Connector	Results
Pin 1 to Pin 2	Normal = approximately 6 $\Omega$ Abnormal = infinity
Pin 2 to Pin 3	Normal = approximately 6 $\Omega$ Abnormal = infinity
Pin 1 to Pin 3	Normal = approximately 6 $\Omega$ Abnormal = infinity

## Water Temperature Sensor

Disconnect the wire harness from the water temperature sensor and measure the resistance of the sensor.

Temperature	Results
32° F (0° C)	35.9K $\Omega$
86° F (30° C)	9.7K $\Omega$
104° F (40° C)	6.6K $\Omega$
122° F (50° C)	4.6K $\Omega$
140° F (60° C)	3.2K $\Omega$
158° F (70° C)	2.3K $\Omega$
203° F (95° C)	1K $\Omega$

## TROUBLESHOOTING GUIDE

PROBLEM	POSSIBLE CAUSE/TEST
WON'T POWER UP. (touch-pads do not respond when pressed)	<p><b>Note: Possible Cause/Tests MUST be performed in the sequence shown for each problem.</b></p> <ol style="list-style-type: none"> <li>1. Check the line voltage and for blown fuses.</li> <li>2. Check for voltage going to Central Control Unit (CCU) by listening for a <b>click</b> in the CCU when unit is plugged in. If <b>no click</b> replace CCU.</li> <li>3. <b>Unplug</b> the unit before continuing.</li> <li>4. Check continuity of line cord and line filter.</li> <li>5. Check harness connections to CCU.</li> <li>6. Check touch-pad/LED assembly.</li> </ol>
WON'T START CYCLE	<ol style="list-style-type: none"> <li>1. Open and close the door. The door has to be opened between consecutive wash cycles.</li> <li>2. Check the door switch/lock unit using the diagnostics.</li> <li>3. If Door is Locked, Drain the Unit.</li> <li>4. Check the wire harness connections.</li> <li>5. Check the touch-pad/LED assembly.</li> </ol>
WON'T SHUT OFF	<ol style="list-style-type: none"> <li>1. Check for a Fault/Error Code on the display.</li> <li>2. Press PAUSE/CANCEL button on the touch-pad twice.</li> <li>3. Check the touch-pad/LED assembly</li> <li>4. Check that the Drain hose and Drain Pump Filter is clear of foreign objects and not plugged.</li> <li>5. Check Drain Pump.</li> <li>6. Check the CCU.</li> </ol>
CONTROL WON'T ACCEPT SELECTIONS	<ol style="list-style-type: none"> <li>1. Press PAUSE/CANCEL button on the touch-pad twice.</li> <li>2. Drain the unit, then check that the Drain hose and Drain Pump Filter is clear of foreign objects.</li> <li>3. Check/ Replace Touch-pad/LED assembly.</li> <li>4. Check harness connections.</li> <li>5. Check the CCU.</li> </ol>
WON'T DISPENSE	<ol style="list-style-type: none"> <li>1. Verify the unit is level.</li> <li>2. Verify Dispenser Drawer is not clogged with detergent.</li> <li>3. Check water connections to the unit and within the unit. Check for plugged screen in water source.</li> <li>4. Check Dispense motor.</li> <li>5. Check harness connections.</li> <li>6. Check CCU.</li> </ol>
WON'T FILL	<ol style="list-style-type: none"> <li>1. Check installation.</li> <li>2. Check inlet valves.</li> <li>3. Check water connections to the unit and within the unit. Check for plugged screen in water source.</li> <li>4. Check Operating Pressure Switch.</li> <li>5. Check the CCU.</li> <li>6. Check under problem "WON'T DISPENSE"</li> </ol>

<b>PROBLEM</b>		<b>POSSIBLE CAUSE/TEST</b>	
		<b>Note: Possible Cause/Tests MUST be performed in the sequence shown for each problem.</b>	
OVER FILLS			<ol style="list-style-type: none"> <li>1. Verify the unit is level.</li> <li>2. Check pump drain system – this could indicate a failure to drain.</li> <li>3. Check Operating Pressure Switch.</li> <li>4. Check Pressure Switch hose.</li> <li>5. Check Flow Meter operation.</li> <li>6. Check the CCU.</li> </ol>
BASKET WON'T ROTATE			<ol style="list-style-type: none"> <li>1. Check Drive belt.</li> <li>2. Check Drive motor.</li> <li>3. Check Wire Harness connections.</li> <li>4. Check Motor Control Unit.</li> </ol>
MOTOR OVERHEATS			<ol style="list-style-type: none"> <li>1. Check Drive motor.</li> <li>2. Check Wire Harness connections.</li> <li>3. Check Drive belt.</li> <li>4. Check Motor Control Unit.</li> </ol>
WON'T DRAIN			<ol style="list-style-type: none"> <li>1. Check Wire Harness connections.</li> <li>2. Check Drain pump.</li> <li>3. Check Drain pump motor.</li> <li>4. Check that the Drain hose and Drain Pump Filter is clear of foreign objects.</li> <li>5. Check the CCU.</li> </ol>
MACHINE VIBRATES			<ol style="list-style-type: none"> <li>1. Remove Shipping system.</li> <li>2. Check installation.</li> <li>3. Check leveling feet.</li> <li>4. Check leveling feet lock nuts.</li> <li>5. Check for weak floor.</li> </ol>
INCORRECT WATER TEMPERATURE			<ol style="list-style-type: none"> <li>1. Check that the Inlet Hoses are connected properly.</li> <li>2. Check the Water Heater and Wire Harness connections to it.</li> <li>3. Check Water Temperature Sensor for an abnormal condition.</li> <li>4. Check the CCU.</li> </ol>

# READING THE CYCLE CHARTS

## Sample Cycle Chart

hand washables																
wash phase		mainwash				rinse		additional rinse			rinse soft			extract		
movement	speed (rpm)	0	31	31	0	0	31	0	0	31	0	0	31	0	800	
	reversing															
	on:mx sec / off:ry sec	0	1.5/30.5	1.5/30.5	0	0	1.5/31.5	0	0	1.5/31.5	0	0	1.5/31.5	0		
	spin cycle														LS3	
level																
	L1															
temp	dispenser box	mw				mw		mw			mw			soft		
	fill	cold, warm				tap cold		tap cold			tap cold			warm		
	heating															
	time	variable	60 sec	5.7 min	var	var	3 min	var						2.3 min	var	3 min
	door	closed				closed		closed			closed			closed		
options	pump (LF + 15s)	off				on		off			on			off		on
	2nd rinse								2 min							
	rinse hold													stop		

### Movement

- **Speed (rpm)** - Revolutions per minute of basket spin.
- **Reversing** - In this example the basket will rotate counterclockwise for 1.5 seconds, stop for 30.5 seconds, then rotate clockwise for 1.5 seconds, stop for 30.5 seconds and then repeat the sequence throughout the wash and rinse portions of the cycle.
- **Spin Cycle** - The spin cycle is described in the charts on pages 6-20 through 6-22. In this example the Hand Washable cycle will use the LS3 spin profile.

### Level

- The pressure switch can detect three levels of water in the tub. L1 indicates the operating water level. In this example the water level allowed through out the cycle is level 2. In other cycles the water level can vary from L1 to L3. The pressure switch will fill to the L1 level, then the flowmeter will allow an additional 50% for L2 and an additional 150%, (from L1), to the L3 level.

### Dispenser Box

- This line describes which portion of the dispenser box will be used during the cycle. In this example only the Main Wash (mw) and Fabric Softener (soft) are used. Other portions of the dispenser box are; Prewash (pw) and Bleach (bleach).

### Temp

- **Fill** - The water temperature is variable based on consumer input and what is allowable by the cycle.
- **Heating** - This depends on whether the unit is equipped with a heating element and whether the cycle calls for heating. In this example the heater is not used

### Time

- This line describes the length of time each portion of the cycle will take. The time for each fill portion is based on input from the pressure switch.

### Door

- The door is locked throughout the cycle except for the Child Security Routine.



## Pump

- **Lf +15s** - The pump will turn on and drain the tub to lowest setting, (Suds Detect), and then run for an additional 15 seconds.

## Options

- **2nd rinse** - If this option is selected by the consumer, this line indicates when it will occur during the main cycle and it's duration.
- **rinse hold** - If this option is selected by the consumer, this line will indicate when it will occur during the main cycle. Pressing Rinse Hold again will allow the main cycle to continue.

# WHIRLPOOL GHW9200L

## sanitary

wash phase speed (rpm)	soak		prewash		mainwash		cool down to 127°F		rinse bleach		additional rinse		rinse soft		extract					
	40	35	40	40	35	40	800	40	35	800	40	35	800	40	35	250	600	1100	35	
reversing on/tx sec / off/tx sec	10/6	2/00	10/6	13/3	10/6	13/3	10/6	LS 1	13/3	10/6	13/3	10/6	LS 2	10/6					8/8	
spin cycle																			LS 2	ES
LI																				
dispenser box																				
fill																				
heating																				
time	5 min	18 min																		
door	closed	open	closed	open	closed	open	closed	open	closed	open	closed	open	closed	open	closed	open	closed	open	closed	open
pump (LI + 15s)	off	on	off	on	off	on	off	on	off	on	off	on	off	on	off	on	off	on	off	on
soak																				
prewash																				
2nd rinse																				
rinse hold																				
options																				

## whitest whites

wash phase speed (rpm)	soak		prewash		mainwash		cool down to 127°F		rinse bleach		additional rinse		rinse soft		extract					
	40	35	40	40	35	40	800	40	35	800	40	35	800	40	35	250	600	1100	35	
reversing on/tx sec / off/tx sec	10/6	2/00	10/6	13/3	10/6	13/3	10/6	LS 1	13/3	10/6	13/3	10/6	LS 2	10/6					8/8	
spin cycle																			LS 2	ES
LI																				
dispenser box																				
fill																				
heating																				
time	5 min	13 min																		
door	closed	open	closed	open	closed	open	closed	open	closed	open	closed	open	closed	open	closed	open	closed	open	closed	open
pump (LI + 15s)	off	on	off	on	off	on	off	on	off	on	off	on	off	on	off	on	off	on	off	on
soak																				
prewash																				
2nd rinse																				
rinse hold																				
options																				

# WHIRLPOOL GHW9200L

## heavy duty

wash phase	soak	prewash	mainwash	cool down to 127°F	rinse bleach	additional rinse	rinse soft	extract
speed [rpm]	40	35	40	800	800	40	35	250
reversing				40	35	800	40	600
on: sec / off: sec	10:06	2:00	10:06	13:03	10:06	13:03	10:06	1100
spin cycle				10:06	LS 1	LS 1	LS 2	ES
L1								
dispenser box	pw							
fill	pw							
temp:	cold...warm	cold...warm	soil level less: cold...hot normal: warm	tap cold	tap cold	tap cold	tap cold...warm	
heating			less: no heating normal: up to 120°F					
time	5 min 18 min	18 min	2-11 min 13-28 min	4 min	4 min	3-4 min	110 s	150 s 5.6min 2 min
door	closed	closed	closed	closed	closed	closed	closed	closed
pump (L1 + 15s)	off	on	off	on	off	on	off	on
soak								
prewash								
2nd rinse								
rinse hold								coop

## Normal/Casual

wash phase	soak	prewash	mainwash	cool down to 99°F	rinse bleach	additional rinse	rinse soft	extract
speed [rpm]	40	35	40	35	250	40	35	250
reversing				40	35	800	40	600
on: sec / off: sec	10:06	2:00	10:06	10:06	10:06	10:06	10:06	1100
spin cycle				10:06	LS 1	LS 1	LS 2	ES
L1								
dispenser box	pw							
fill	pw							
temp:	cold...warm	cold...warm	soil level more/less 10:06 normal 8:0	tap cold	tap cold	tap cold	tap cold...warm	
heating								
time	5 min 18 min	18 min	7-20 min	3 min	3 min	2-4 min	110 s	16min 2 min
door	closed	closed	closed	closed	closed	closed	closed	closed
pump (L1 + 15s)	off	on	off	on	off	on	off	on
soak								
prewash								
2nd rinse								
rinse hold								stop



# WHIRLPOOL GHW9200L

## wool = silk (without extract)

	wash phase		mainwash		rinse		additional rinse		rinse soft		extract	
	speed [rpm]	0	31	31	0	0	31	0	0	31		0
drum movement	reversing	0	1,5/30,5	1,5/30,5	0	0	1,5/31,5	0	0	1,5/31,5	0	LS3
	on+ sec / off+ sec											
	spin cycle											
water level	L1											
temp	dispenser box	mw	cold, warm		mw	tap cold		mw	tap cold	mw	soft	
	fill									tap cold, warm		
	heating											
	time		60 sec	5,7 min	ver	2 min	closed	ver	2,3 min	ver	3 min	closed
	door		closed			closed			closed		closed	
	pump (LF + 15s)		off	on	off	off	on	on	off	off	on	on
options	2nd rinse							2 min				
	rinse hold										stop	

## hand washables

	wash phase		mainwash		rinse		additional rinse		rinse soft		extract	
	speed [rpm]	0	31	31	0	0	31	0	0	31		0
drum movement	reversing	0	1,5/30,5	1,5/30,5	0	0	1,5/31,5	0	0	1,5/31,5	0	LS3
	on+ sec / off+ sec											
	spin cycle											
water level	L1											
temp	dispenser box	mw	cold, warm		mw	tap cold		mw	tap cold	mw	soft	
	fill									tap cold, warm		
	heating											
	time		60 sec	5,7 min	ver	3 min	closed	ver	2,3 min	ver	3 min	closed
	door		closed			closed			closed		closed	
	pump (LF + 15s)		off	on	off	off	on	on	off	off	on	on
options	2nd rinse							2 min				
	rinse hold										stop	

# WHIRLPOOL GHW9100L

## whitest whites

	wash phase	mainwash	cool down to 127°F	rinse bleach	additional rinse	rinse soft	extract
speed (rpm)	35   40	40	800	35	800	40	250
reversing							
on+sec / off+sec	13/3	10/6		13/3	10/6	13/3	10/6
spin cycle			LS 1		LS 1		LS 2
water level	L1						
dispenser box	mw						
temperature	mw   bleach						
fill	cold... hot						
time	7.22 min	4 min	4 min	4 min	tap cold	tap cold	110 s
door	closed	closed	closed	closed	closed	closed	closed
Pump (L1 + 15s)	off	on	on	off	on	off	on
2nd rinse					3min		
rinse hold						stop	
options							

## heavy duty

	wash phase	mainwash	cool down to 127°F	rinse bleach	additional rinse	rinse soft	extract
speed (rpm)	35   40	40	800	35	800	40	250
reversing							
on+sec / off+sec	13/3	10/6		13/3	10/6	13/3	10/6
spin cycle			LS 1		LS 1		LS 2
water level	L1						
dispenser box	mw						
temperature	mw   bleach						
fill	cold... hot						
time	7.22 min	4 min	4 min	4 min	tap cold	tap cold	110 s
door	closed	closed	closed	closed	closed	closed	closed
Pump (L1 + 15s)	off	on	on	off	on	off	on
2nd rinse					3min		
rinse hold						stop	
options							

# WHIRLPOOL GHW9100L

## Normal/Casual

wash phase	mainwash		cool down to 90°F		rinse bleach		additional rinse		rinse soft		extract	
	speed (rpm)	40	35	250	40	35	600	40	35	600	40	35
reversing												
on-x sec / off-y sec	10/6		10/6		10/6		10/6		10/6			6/10
spin cycle					LS 1		LS 1		LS 1			LS 2 LS 4
water level												
dispenser box												
temperature												
fill												
time												
door												
options												

## delicate

wash phase	mainwash		cool down to 90°F		rinse bleach		additional rinse		rinse soft		extract	
	speed (rpm)	40	40	35	0	40	35	0	40	35	0	250
reversing												
on-x sec / off-y sec	10/6		6/10		6/10		6/10		6/10			6/10
spin cycle												LS 2 LS 3
water level												
dispenser box												
temperature												
fill												
time												
door												
options												

# WHIRLPOOL GHW9100L

handwash															
wash phase		mainwash				rinse				additional rinse		rinse soft		extract	
drum movement	speed [rpm]	0	31	31	0	0	31	0	0	31	0	0	31	0	800
	reversing														
	on/mx sec / off/ry sec	0	1.5/30.5	1.5/30.5	0	0	1.5/31.5	0	0	1.5/31.5	0	0	1.5/31.5	0	
spin cycle														LS3	
water level															
	L1														
temperature	dispenser box	mw				mw				mw		mw/soft			
	fill	cold..warm				tap cold				tap cold		tap cold..warm			
	time	60 sec	5.7 min			3 min						2.3 min		3 min	
	door	closed				closed				closed		closed		closed	
	pump (L1 + 15s)	off				on				off		on		on	
options	2nd rinse									2.3 min					
	rinse hold											stop			

## SPIN PROFILES

### Spin Cycle LS1

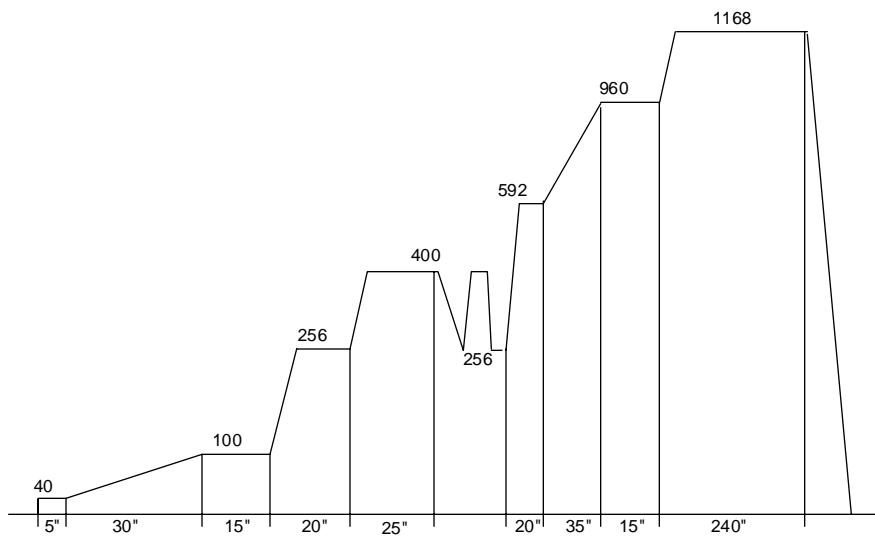



# Spin Cycle LS2

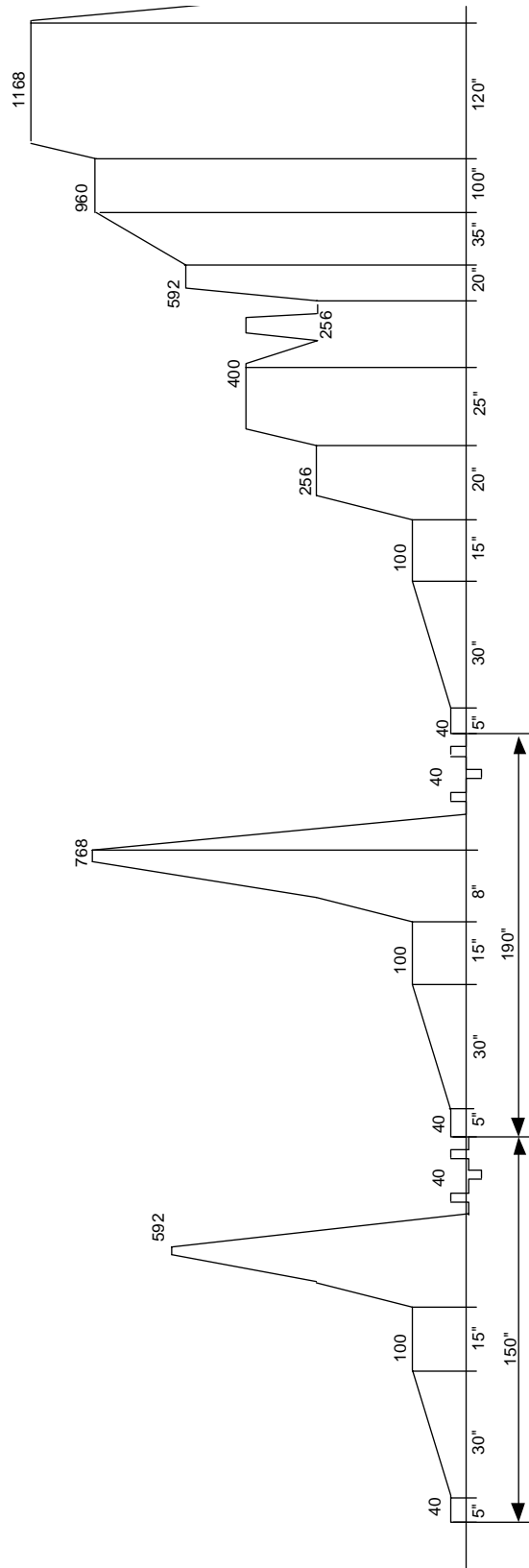

### Spin Cycle LS3

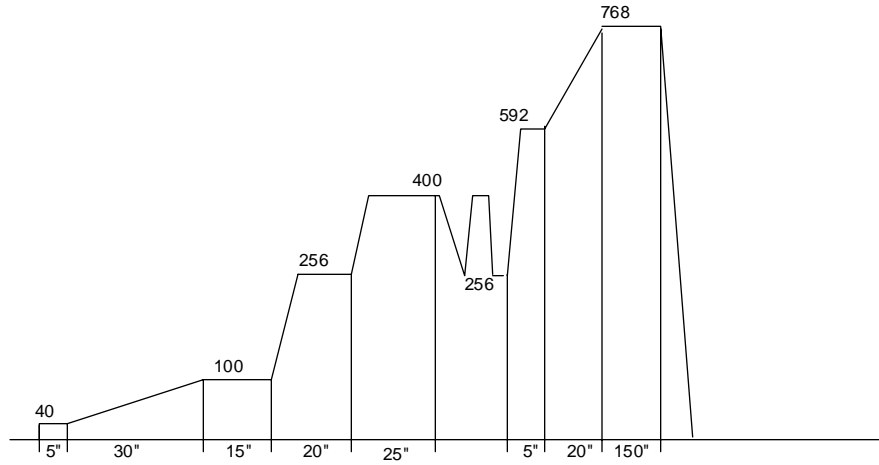

### Spin Cycle LS4

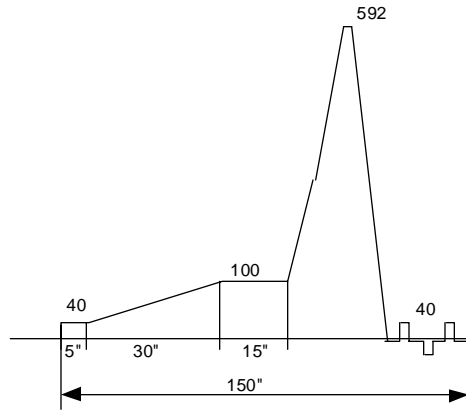

### Spin Cycle ES

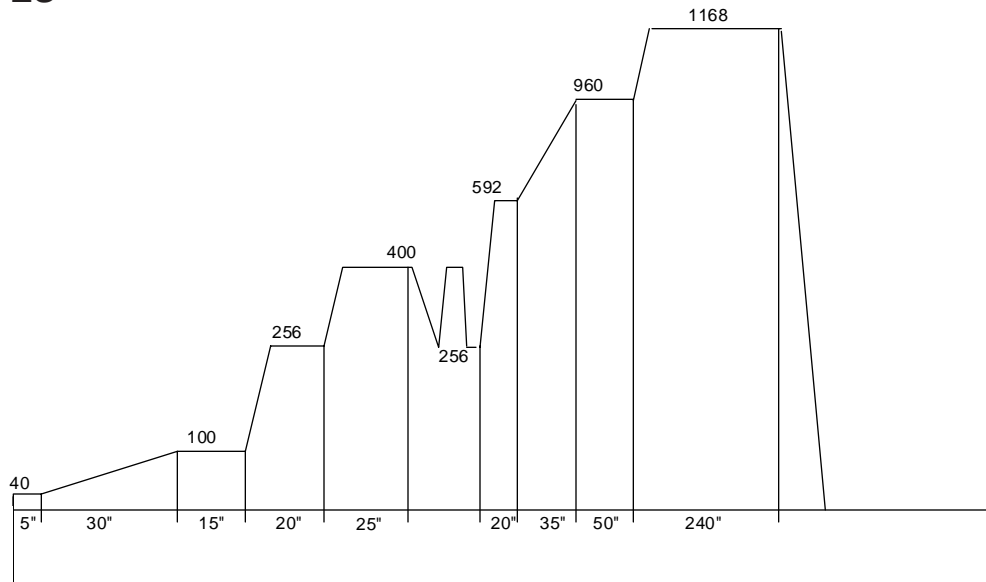

# WIRING DIAGRAM

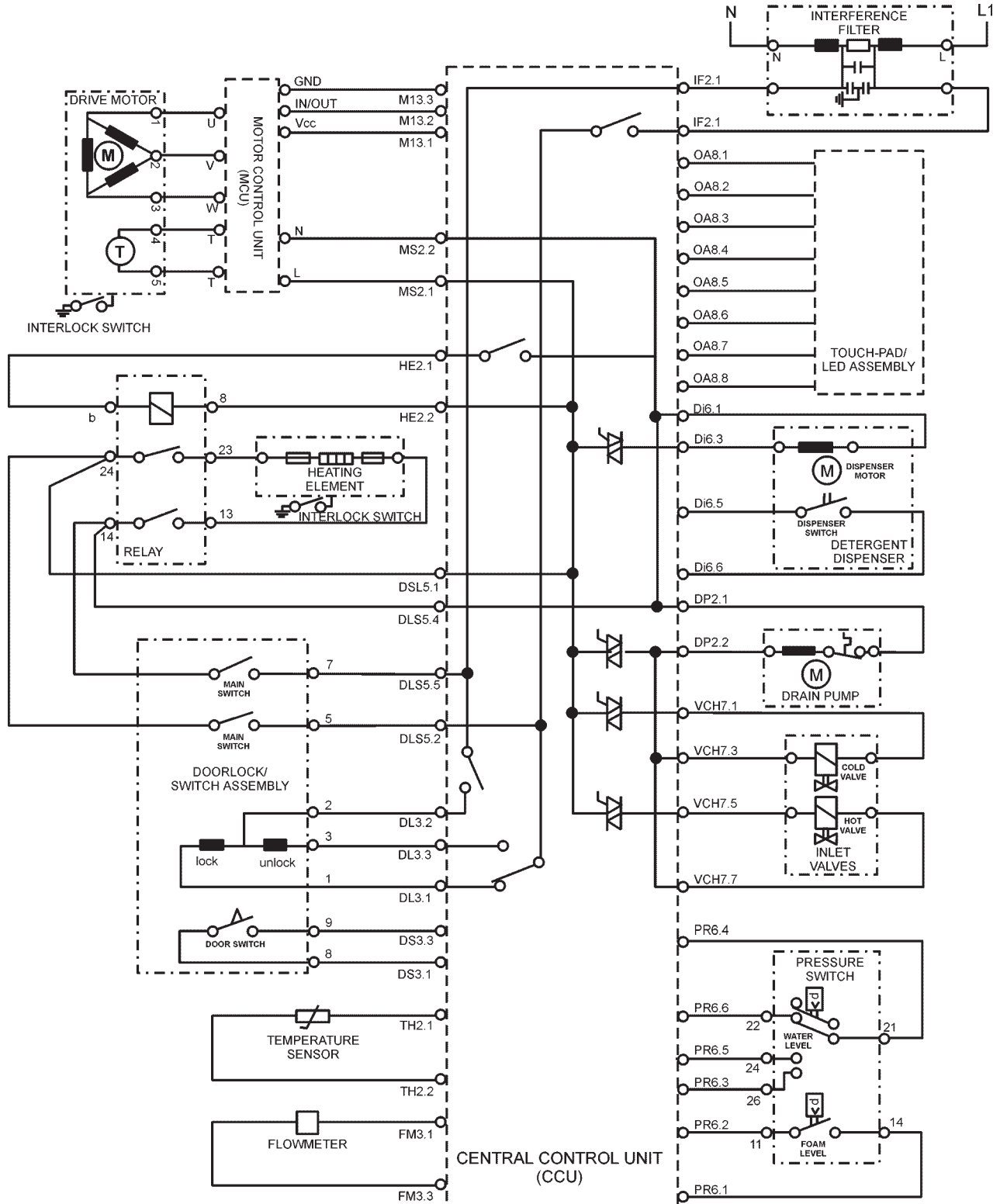

-- NOTES --

# TECH TIPS

## MANUAL DOOR LATCH

### To Manually unlock the door lock system:

1. Unplug the power cord from the outlet.
2. Remove the lower toe panel.
3. Reach up along the inside of the front panel and locate the bottom of the door latch assembly.
4. Located on the bottom of the door latch assembly is a tear-drop shaped tab.
5. Gently pull the tab down about ¼" or until a click is heard.
6. The door may now be opened.

## DOOR PLUNGER

A manual door plunger is available to prevent door closure. (Child Safety Device) When the plunger is in the OUT position (*Fig. 8-1*), it prevents the door from latching. To activate this feature, a coin is inserted in the plunger slot and rotated counterclockwise 90°. To reengage the plunger to the IN position (*Fig. 8-2*), rotate plunger 90° clockwise.



*Fig. 8-1*



*Fig. 8-2*

-- NOTES --

# **PRODUCT SPECIFICATIONS AND WARRANTY INFORMATION SOURCES**

**IN THE UNITED STATES:**

**FOR PRODUCT SPECIFICATIONS AND WARRANTY INFORMATION CALL:**

FOR WHIRLPOOL PRODUCTS: 1-800-253-1301

FOR KITCHENAID PRODUCTS: 1-800-422-1230

FOR ROPER PRODUCTS: 1-800-447-6737

**FOR TECHNICAL ASSISTANCE WHILE AT THE CUSTOMER'S HOME CALL:**

THE TECHNICAL ASSISTANCE LINE: 1-800-253-2870

**HAVE YOUR STORE NUMBER READY TO IDENTIFY YOU AS AN  
AUTHORIZED SERVICER**

**FOR LITERATURE ORDERS:**

PHONE : 1-800-851-4605

---

**IN CANADA:**

**FOR PRODUCT SPECIFICATIONS AND WARRANTY INFORMATION CALL:**

1-800-461-5681

**FOR TECHNICAL ASSISTANCE WHILE AT THE CUSTOMER'S HOME CALL:**

THE TECHNICAL ASSISTANCE LINE: 1-800-488-4791

**HAVE YOUR STORE NUMBER READY TO IDENTIFY YOU AS AN  
AUTHORIZED SERVICER**

