



CONSUMER SERVICES TECHNICAL
EDUCATION GROUP PRESENTS

CL-9

HIGH EFFICIENCY TOP LOAD COMMERCIAL WASHER

Model CAW2762K



JOB AID
Part No. 8178129

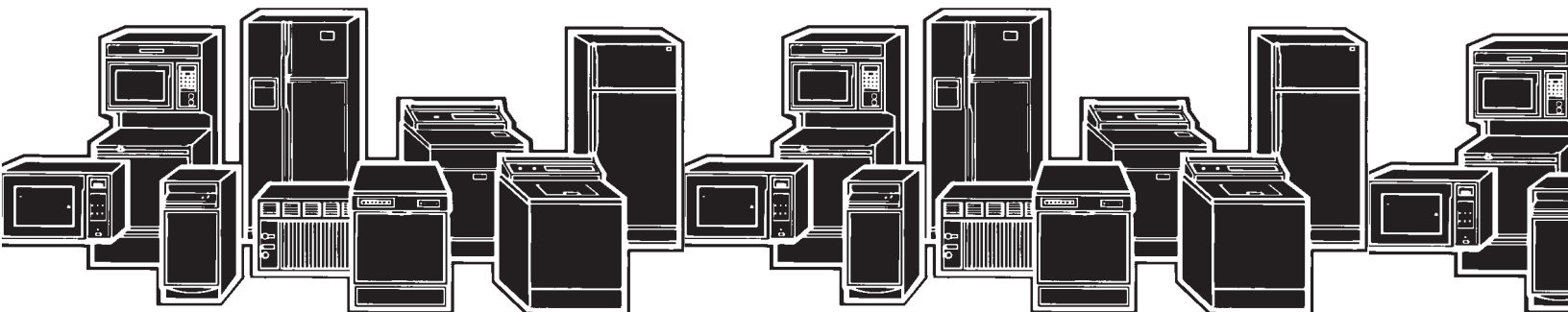

FORWARD

This Whirlpool Job Aid, “High Efficiency Top Load Commercial Washer,” (Part No. 8178129), provides the technician with information on the installation, operation, and service of the High Efficiency Top Load Commercial Washer. It is to be used as a training Job Aid and Service Manual. For specific information on the model being serviced, refer to the “Tech Sheet” provided with the washer.

The Wiring Diagram is typical and should be used for training purposes only. Always use the Wiring Diagram supplied with the product when servicing the unit.

GOALS AND OBJECTIVES

The goal of this Job Aid is to provide detailed information that will enable the service technician to properly diagnose malfunctions and repair the Whirlpool High Efficiency Top Load Commercial Washer.

The objectives of this Job Aid are to:

- Understand and follow proper safety precautions.
- Successfully troubleshoot and diagnose malfunctions.
- Successfully perform necessary repairs.
- Successfully return the washer to its proper operational status.

WHIRLPOOL CORPORATION assumes no responsibility for any repairs made on our products by anyone other than Authorized Service Technicians.

TABLE OF CONTENTS

	Page
GENERAL	1-1
Safety First	1-1
Model & Serial Number Designations	1-3
Model & Serial Number Label And Literature Pack Locations	1-4
Specifications	1-5
Warranty	1-6
INSTALLATION INFORMATION	2-1
Washer Installation Instructions	2-1
THEORY OF OPERATION	3-1
COMPONENT ACCESS	4-1
Component Locations	4-1
Removing The Console Components	4-2
Removing The Meter Case Assembly Components	4-5
Removing The Hidden Lid Switch	4-8
Removing The Pump, Motor Start Capacitor, & Motor	4-10
Removing The Agitator & Transmission	4-12
Removing The Cabinet Assembly	4-15
Removing The Dual Vacuum Break	4-17
Removing The Tub Ring, Basket, Outer Tub, And Basket Drive Assembly	4-18
Removing The Suspension System & Base Assembly	4-22
Removing The Rear Panel High Efficiency Components	4-23
COMPONENT TESTING	5-1
Diverter Valve	5-1
Motor	5-2
Motor Thermal Protector	5-3
Thermistor	5-4
Hidden Lid Switch	5-5
Motor Start Capacitor	5-5
Pressure Switch	5-6
Cycle Selector Switch Assembly	5-7
Timer Motor	5-7
Basket Drive Shaft Checks	5-8
Automatic Temperature Control	5-9
DIAGNOSIS AND TROUBLESHOOTING	6-1
Cycle Chart	6-1
Agitation Cycle Switch Closures	6-2
Sequence Chart	6-2
Bussing Diagram	6-3
Timer Label	6-3
Connectors	6-4
WIRING DIAGRAM	7-1

— NOTES —

GENERAL SAFETY FIRST

Your safety and the safety of others is very important.

We have provided many important safety messages in this Job Aid and on the appliance. Always read and obey all safety messages.



This is the safety alert symbol.

This symbol alerts you to hazards that can kill or hurt you and others.

All safety messages will follow the safety alert symbol and either the word "DANGER" or "WARNING." These words mean:

! DANGER

You can be killed or seriously injured if you don't immediately follow instructions.

! WARNING

You can be killed or seriously injured if you don't follow instructions.

All safety messages will tell you what the potential hazard is, tell you how to reduce the chance of injury, and tell you what can happen if the instructions are not followed.

! WARNING



Electrical Shock Hazard

Disconnect power before servicing.

Replace all parts and panels before operating.

Failure to do so can result in death or electrical shock.

! WARNING



Electrical Shock Hazard

Plug into a grounded 3-prong outlet.

Do not remove ground prong.

Do not use an adapter.

Do not use an extension cord.

Failure to follow these instructions can result in death, fire, or electrical shock.

! WARNING

Excessive Weight Hazard

Use two or more people to move and install washer.

Failure to do so can result in back or other injury.

⚠ WARNING



Electrical Shock Hazard

Connect green ground wire to ground screw.

Failure to do so can result in death or electrical shock.

IMPORTANT

Electrostatic Discharge (ESD) Sensitive Electronics

ESD problems are present everywhere. ESD may damage or weaken the electronic control assembly. The new control assembly may appear to work well after repair is finished, but failure may occur at a later date due to ESD stress.

- Use an antistatic wrist strap. Connect the wrist strap to the green ground connection point, or to an unpainted metal surface in the appliance.

- OR -

- Touch your finger repeatedly to a green ground connection point, or to an unpainted metal surface in the appliance.
- Before removing the part from its package, touch the antistatic bag to a green ground connection point, or to an unpainted metal surface in the appliance.
- Avoid touching electronic parts, or terminal contacts. Handle the electronic control assembly by the edges only.
- When repackaging the failed electronic control assembly in an antistatic bag, observe the previous instructions.

MODEL & SERIAL NUMBER DESIGNATIONS

MODEL NUMBER

MODEL NUMBER	Y	C	A	W	27	6	2	K	Q	0
INTERNATIONAL SALES INDICATOR OR MARKETING CHANNEL										
Y = Canada										
G = Government On Premise										
PRODUCT GROUP										
C = Commercial Laundry										
PRODUCT IDENTIFICATION										
A = Automatic Washer										
E = Electric Dryer										
G = Gas Dryer										
S = Stack Dryer										
CONTROL CODE										
E = Electronic Control										
M = Electromechanical										
P = Pushbutton Single Unit or Stacked Pair										
W = High Efficiency Top Load										
FEATURE CODE										
Cabinet Width In Inches (29" or 27")										
FEATURE / VARIATIONS										
4 = Meter Case or Coinslide Equipped Stack W/O Windows										
5 = Meter Case and Coinslide Equipped										
6 = Meter Case or Coinslide Equipped Stack With Windows										
7 = Card Reader Ready / Equipped Stacked Pair										
9 = Full Width Console										
FEATURE CODE										
0 = Electric										
1 = Single Speed or Gas										
2 = Two Speed										
YEAR OF INTRODUCTION										
J = 2000, K = 2001										
COLOR CODE										
Q = White										
ENGINEERING REVISION NUMBER										
0 = Basic, 1 = 1st Revision, 2 = 2nd Revision										

SERIAL NUMBER

SERIAL NUMBER	C	L	16	02287
MANUFACTURING SITE				
C = Clyde, OH				
YEAR OF PRODUCTION				
L = 2001, M = 2002				
WEEK OF PRODUCTION				
PRODUCT SEQUENCE NUMBER				

MODEL & SERIAL NUMBER LABEL AND LITERATURE PACK LOCATIONS

The Model & Serial Number label location is shown below. A Literature Pack (not shown) is located behind the front access panel. The pack includes a wiring diagram, parts list, and tech sheet.

Model & Serial Number Label Location



SPECIFICATIONS

MODEL NUMBER	CAW2762KQ0
GENERAL INFORMATION	Stainless steel look console, hidden lid switch, porcelain finish top and lid, galvanized, extra thick front panel, galvanized side panels, improved meter case that accepts larger coin box, coinslide or card retrofit kit, reliable single piece agitator, front panel lock ready Commercial-Grade, Color-Coded Water Inlet hoses with Brass Couplings and Drain Hose included
MOTOR Direct-Drive with Built-In Overload Protector	Two-Speed 1/2-HP 120V
AGITATION STROKES PER MINUTE/ AMPERAGE Maximum rated current	180 spm/high (5.0 AMPS no load) 120 spm/low (5.0 AMPS no load) 9.8 AMPS (120V)
MOTOR RPM	1725 HIGH, 1140 LOW
SPIN RPM	640 HIGH, 420 LOW
ELECTRICAL REQUIREMENTS	120-volt, 60 Hz., A.C. standard 15-amp breaker/ fuse branch circuit for each washer (subject to local codes)
ENERGY CONSUMPTION MEF (MODIFIED ENERGY FACTOR) MEF = C / ETe + De* WF (Water Factor) KW/cycle	1.26 KWh/Cycle/Cu. Ft.** 7.3 Gallons/cycle/cu. Ft.** 3.8178
WATER CONSUMPTION HIGH WATER LEVEL	28.5 gallons (approx.) based on 12.5 lb. load
LOW WATER LEVEL	16.3 gallons (approx.), based on 3 lb. load
AVERAGE CONSUMPTION	22.4 gallons
DIMENSIONS See illustration in installation section	43"H (at meter case top), 35"H (at lid), 27"W, 25.5"D
SHIPPING WEIGHT (EST.)	184
BASKET VOLUME	3.03 CU FT

*C = basket capacity in Cu. Ft.

E_{Te} = total machine energy (water heat plus mechanical) in kWh. De = dryer energy in kWh. Water heat (E_t) energy is obtained by using the hot gallons fill and factoring by load and temperature use values. These values depend on whether the unit in question is adaptive or user selectable for the fills.

Mechanical energy (Me) represents the energy used by just the machine (drive motor, valves, etc.). It is also factored by load and use values and is added to the water heat energy to obtain the total machine energy (E_{Te}).

Dryer energy (De) is based on RMC, which is remaining moisture content, obtained with the maximum load from the table in the energy standard.

All the formulas are in the energy standard for washers which is 10 CFR PART 430, SUBPART B

** California standard is 9.5 WF, 1.26 MEF

WARRANTY

LENGTH OF WARRANTY:	WHIRLPOOL WILL PAY FOR:	WHIRLPOOL WILL NOT PAY FOR:
LIMITED THREE-YEAR WARRANTY FROM DATE OF PURCHASE	FSP® replacement parts only to correct defects in materials or workmanship. Service must be provided by a Whirlpool-designated service company.	A. Service calls to: <ol style="list-style-type: none"> 1. Correct the installation of the washer. 2. Instruct you how to use the washer. 3. Replace fuses or correct wiring. B. Repairs when the washer is used in other than normal, commercial use. C. Pickup and delivery. The washer is designed to be repaired where it is installed. D. Damage to the washer caused by accident, alteration, misuse, abuse, fire, flood, acts of God, or use of products not approved by Whirlpool. E. Repairs to parts or systems resulting from unauthorized modifications made to the washer. F. Replacement parts for units operated outside the United States.
LIMITED FOUR-YEAR WARRANTY FROM DATE OF PURCHASE	For four years from the date of purchase, FSP® replacement parts only to correct defects in the gearcase assembly.	
LIMITED SEVEN-YEAR WARRANTY FROM DATE OF PURCHASE	For seven years from the date of purchase, FSP® replacement parts only to correct defects in the cabinet and lid assembly for rust-through, and for defects in the bearing and support assembly.	
LIMITED TEN-YEAR WARRANTY FROM DATE OF PURCHASE	For ten years from the date of purchase, FSP® replacement parts only to correct defects in the washbasket and outer tub.	

WHIRLPOOL CORPORATION SHALL NOT BE LIABLE FOR INCIDENTAL OR CONSEQUENTIAL DAMAGES.

Some states do not allow the exclusion or limitation of incidental or consequential damages, so this exclusion or limitation may not apply to you. This warranty gives specific legal rights and you may also have other rights which vary from state to state.

Outside the United States, a different warranty may apply. For details, please contact your authorized Whirlpool dealer.

If you need service, first see the “Diagnosis and Troubleshooting” section of this Job Aid. After checking “Diagnosis and Troubleshooting,” additional help can be found by calling, **1-800-NO BELTS**, from anywhere in the U.S.A., or at **www.coinop.com**.

INSTALLATION INFORMATION

WASHER INSTALLATION INSTRUCTIONS



⚠ WARNING

Electrical Shock Hazard

Disconnect power before servicing.

Replace all parts and panels before operating.

Failure to do so can result in death or electrical shock.

Check location where washer will be installed. Proper installation is your responsibility. Make sure you have everything necessary for correct installation.

Single washer installations require 30 cm (12 inch) minimum risers to provide an air cushion and prevent noise and damage to valves.

Grounded electrical outlet is required. See "Washer Electrical Requirements" on page 2-2.

Hot and cold water faucets must be within 1.2 meters (4 feet) of the back of the washer and provide water pressure 690 kPa (10-100 PSI). A pressure reduction valve should be used in the supply line where inlet pressure entering the building exceeds 690 kPa (100 PSI) to prevent damage to the washer mixing valve.

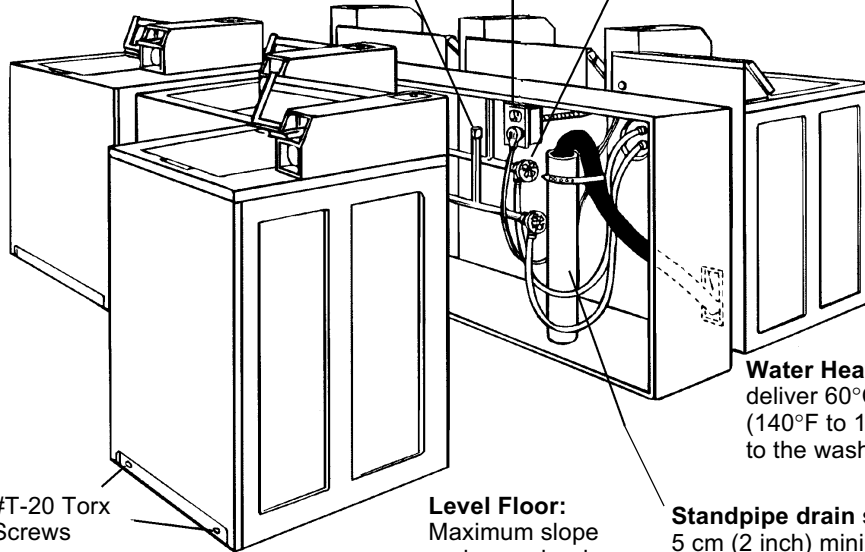

Untape and open washer lid. Remove packages and hoses from washer.

#T-20 Torx Screws

Level Floor:
Maximum slope under washer is 2.5 cm (1 inch).

Water Heater: Set to deliver 60°C to 70°C (140°F to 160°F) water to the washer.

Standpipe drain system: Needs a 5 cm (2 inch) minimum carry-away capacity of 64.4 liters (17 gallons) per minute. Top of standpipe must be at least 86.4 cm, (34 inches) high and no higher than 183 cm (72 inches) from bottom of washer.

On coin-operated washers, front access to the pump area is available by removing the two #T-20 Torx screws and then removing the front panel.

Important: Observe all governing codes and ordinances.

A floor drain should be provided under the bulkhead. Prefabricated bulkheads with electrical outlets, water supply lines, and drain facilities should be used only where local codes permit.

Support: Floor must be sturdy enough to support loaded washer weight of 143 Kg (315 pounds).

TOOLS NEEDED FOR INSTALLATION

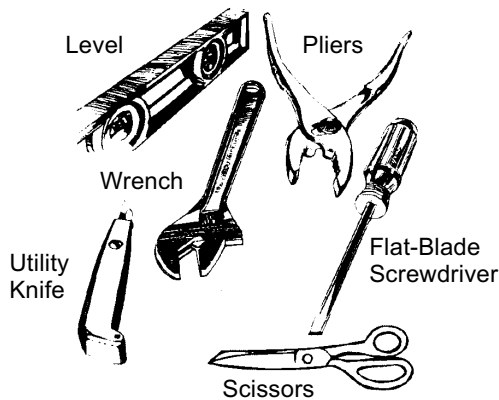

PARTS SUPPLIED FOR INSTALLATION

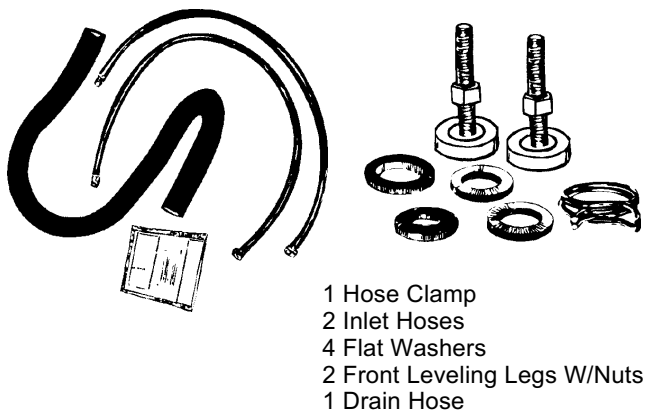

- 1 Hose Clamp
- 2 Inlet Hoses
- 4 Flat Washers
- 2 Front Leveling Legs W/Nuts
- 1 Drain Hose

WASHER ELECTRICAL REQUIREMENTS

⚠ WARNING



Electrical Shock Hazard

- Plug into a grounded 3-prong outlet.
- Do not remove ground plug.
- Do not use adapter.
- Do not use an extension cord.
- Failure to do so can result in death or electrical shock.

If codes permit and a separate ground wire is used, it is recommended that a qualified electrician determine that the ground path is adequate.

Do Not ground to a gas pipe. Check with a qualified electrician if you are not sure the washer is properly grounded.

Do Not have a fuse in the neutral or ground circuit. A 120-volt, 60-Hz, AC-only, 15- or 20-ampere fused electrical supply is required. (Time-delay fuse or circuit breaker is recommended.)

It is recommended that a separate circuit serving only this appliance be provided.

Recommended Ground Method

For the safety of the customer, this washer must be grounded. The washer is equipped with a power supply cord that has a 3-prong grounding plug.

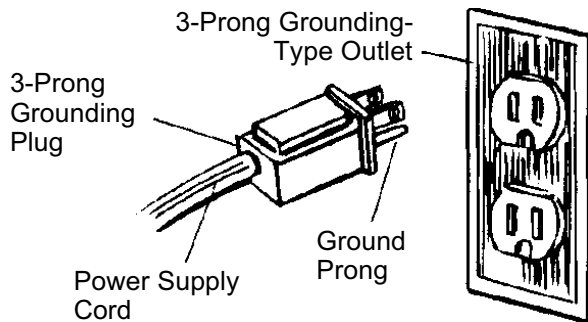

To minimize a possible shock hazard, the cord must be plugged into a mating 3-prong grounding-type receptacle, which has been grounded in accordance with National Electrical Code (ANSI/NFPA 70), and all local and state codes.

If a mating outlet is not available, it is the personal responsibility and obligation of the customer to have a properly grounded 3-prong outlet installed by a qualified electrician.

WARNING: Improper connection of the equipment-grounding conductor can result in a risk of electric shock. Do not modify the plug provided with the appliance. If it will not fit the outlet, have a proper outlet installed by a qualified electrician.

INSTALLING THE WASHER

⚠ WARNING

Excessive Weight Hazard

Use two or more people to move and install washer.

Failure to do so can result in back or other injury.

Removing the shipping strap is necessary for smooth operation. If the shipping strap is not removed, the washer will make excessive noise.

1. Do not cut yellow strap. Pull yellow strap firmly, until completely removed from washer. Depending on your model, there will be either two or three cotter pins on the end of the shipping strap when it is pulled out of the washer. The electrical plug is attached to this shipping strap.

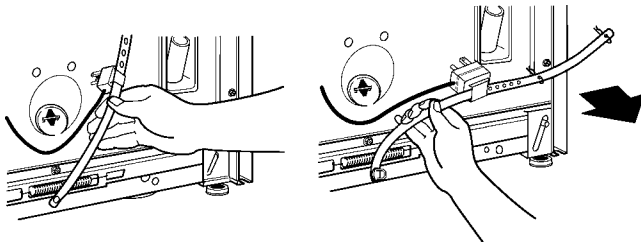

2. The shipping strap plug must be completely removed from the washer for the self-leveling legs to be released. Save the shipping strap for use in step 7.
3. Insert a flat washer into **each** end of the inlet hoses. Check that washers are firmly seated in couplings.

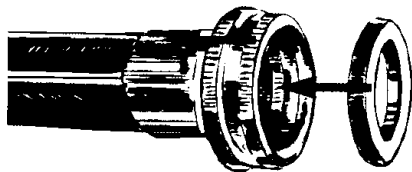

4. Attach hose to bottom inlet valve opening first. Then second hose to top inlet. Tighten couplings by hand; then use pliers to make an additional two-thirds turn. Slide washer onto cardboard or hardboard before moving across floor.

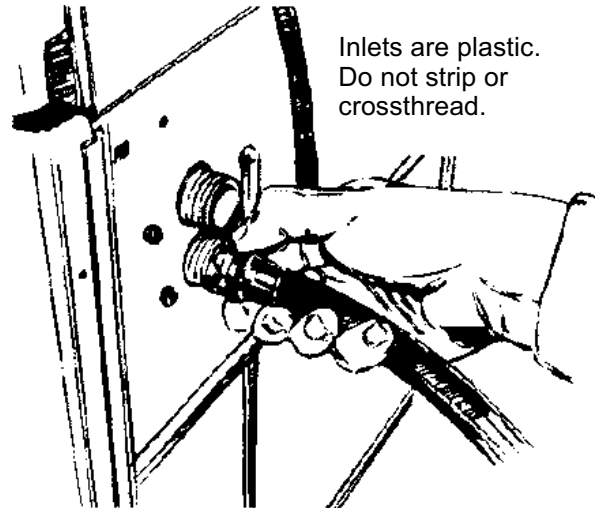

5. Move washer close to final position. Put "hook" end of drain hose into stand pipe. Estimate length of drain hose needed when washer is in final position. Hose must be cut exactly to length so "hook" end is held tightly over edge of stand pipe. If drain hose is too long, cut straight end of hose. **(Do Not cut "hook" shaped end of drain hose.)** Do not force excess length of drain hose down the standpipe. This could cause siphoning. See step 8.

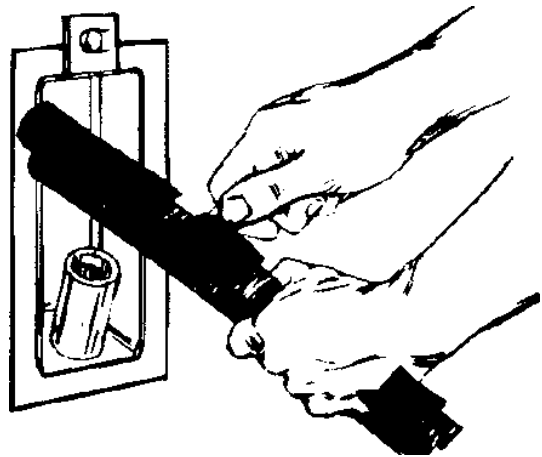

6. Place hose clamp over washer drain connector. Push drain hose onto washer connector. Use pliers to open clamp and slide clamp over drain hose. Check for good fit.

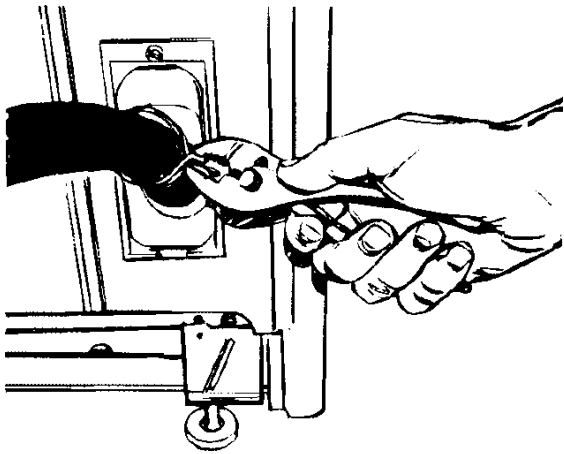

7. Measure and mark a point approximately 40.6 cm (16 inches) from the plug end of the shipping strap. Cut this shipping strap at this point.

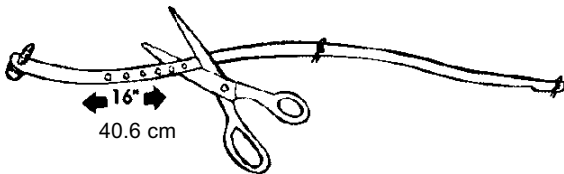

8. Put "hook" end of drain hose into standpipe. Tightly wrap the shipping strap around the stand pipe. Push plug into the nearest hole in the shipping strap. Check that hose is not twisted or kinked and is securely in place.

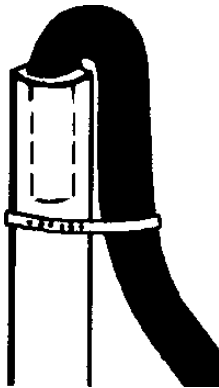

9. Before attaching water inlet hoses, run water through both faucets into a bucket. This will get rid of particles in water lines that might clog hoses. Mark which is the hot water faucet.

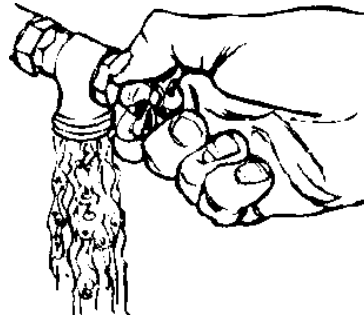

10. Attach bottom hose (inlet marked "H") to hot water faucet. Attach top (inlet marked "C") to cold water faucet. Tighten coupling to faucet by hand, then use pliers to make final two thirds turn.
11. Prop up the front of the washer about 4 in. (10.2 cm) with a wood block, or similar object. The block needs to support the weight of the washer.
12. Screw the locknut onto each foot to within 1 in. (2.5 cm) of the base.

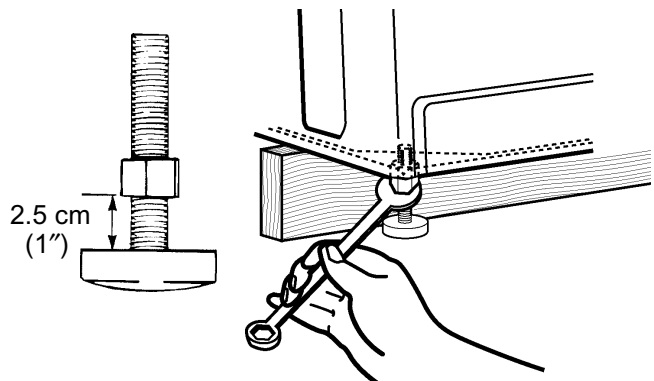

13. Screw the feet into the correct holes at the front corner of the washer until the nuts touch the washer. NOTE: Do not tighten the nuts until the washer is level, step 17.

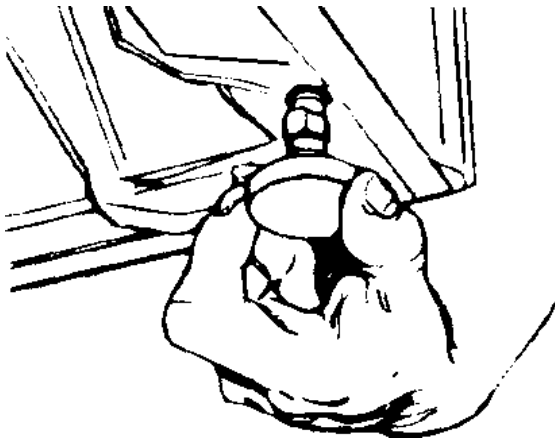

14. Tilt washer backward and remove the wood block. Gently lower washer to floor. Move washer to its permanent location. Remove cardboard or hardboard from under washer.
15. Tilt washer forward raising back legs 2.5 cm (1 inch) off of floor. To adjust rear leveling legs, gently lower washer to floor.

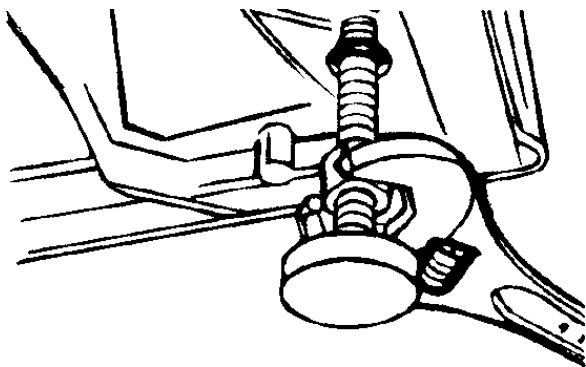

16. Check for level by placing a level on top of the washer, first side to side, then front to back.

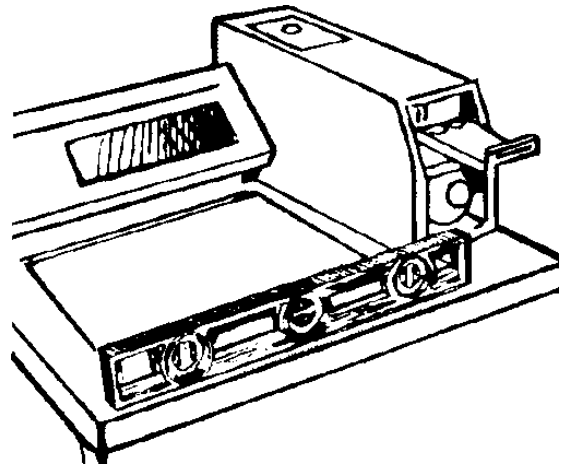

17. If washer is not level, adjust the front legs up or down. Make final check with level. Best results are obtained when the washer is tilted 1/4 bubble toward the rear and level side to side. When washer is level, use wrench to turn nuts on front legs up tightly against washer base. If nuts are not tight against washer base, the washer may vibrate.
18. Check that all parts are now installed. If there is an extra part, go back through steps to see which step was skipped.
19. Turn on water faucets and check for leaks. Tighten couplings if there is leaking. Do Not over tighten; this could cause damage to faucets.
20. Check that you have all of your tools. Check that the shipping strap with 2 cotter pins and plug was removed from the back of the washer and used to secure the drain hose. If entire strap is not removed, washer may vibrate and be noisy.
21. Untape power supply cord.
22. Plug into a grounded 3-prong outlet.
23. Install the chosen money acceptor per the instructions under the appropriate money acceptor section of this Job Aid.

MONEY ACCEPTOR INSTALLATION

A money acceptor is a mechanical or SMART card device that allows the Washer to start after value in the form of coins or card debit is input into the acceptor. The High Efficiency Top Load Commercial Washer comes from the factory without any money acceptors installed. The end user must install the money acceptor of their choice from a manufacturer of these devices. Money acceptors are available in three basic varieties: coinslides, coindrops and SMART cards. Current mechanical models can accept both slides and card readers.

Washer run time is not additive. Once the wash cycle begins, no additional time can be added. Any coinslide activity during the wash cycle is wasted.

NOTE: Whirlpool Corporation does not warranty the proper operation of field-installed, non-factory supplied accessories, such as money acceptors. Physical modification of the product in excess of bolting on accessories, may void the product warranty.

COINSLIDE INSTALLATION

⚠️ WARNING



Electrical Shock Hazard

Disconnect power before servicing.

Replace all parts and panels before operating.

Failure to do so can result in death or electrical shock.

The following procedure will guide the user through coinslide installation and vend price change for a factory equipped or ESD vertical 8 coinslide. The procedure will be similar for other coinslides. Consult the manufacturers instructions for other models.

If the coinslide is installed in the washer, it must be removed prior to changing the vend price. If the coinslide has not yet been installed, skip to step 6.

1. Unplug washer or disconnect power.
2. Remove meter case top access panel.
3. Remove any existing money acceptor if currently installed. If the current acceptor is a coinslide, unscrew the coinslide retaining bolt with a 5/16" socket by turning counterclockwise, and remove the bolt.

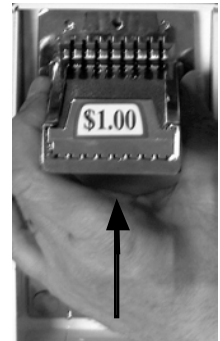
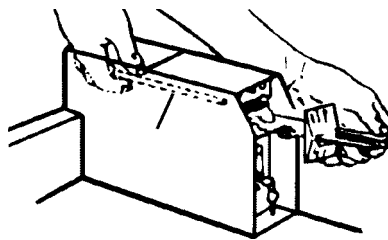

4. Push the coinslide up, and then remove from the meter case.
5. Coinslides and extensions are available from manufacturers of these devices, pictured is typical for use on all mechanical models.



6. Install the washer coinslide extension onto the coinslide using the screws packed with the coinslide kit. The vend price may now be adjusted from \$.25 to \$2.00 on a V8 coinslide as needed. To change the vend price, follow steps 7-14.



7. Set the coinslide and extension assembly on a level surface and remove the return spring(s) from the spring bracket.

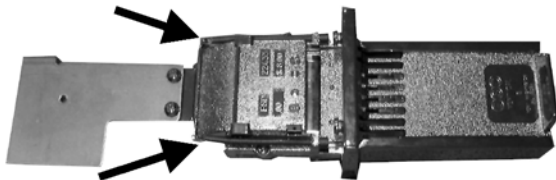

8. Place coins in the coinslide of the proper vend amount (factory preset on coin-equipped models is \$1.00) and push the coinslide all the way in until the coins drop through the coinslide.

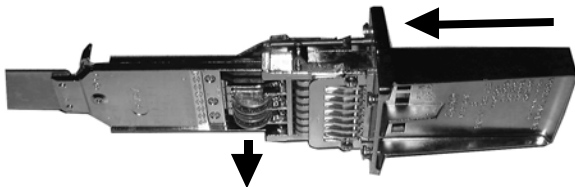

9. With the coinslide still all the way inserted, remove the spring bracket screw and spring bracket.

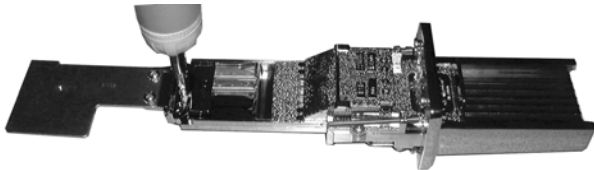

10. Remove the coin inserts (2 blank, 2 functional) from the coinslide area shown below.

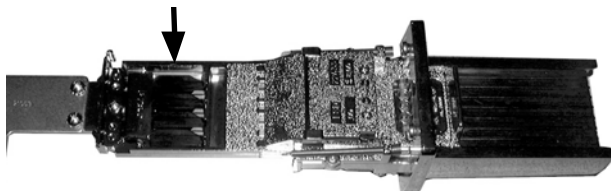

NOTE: The coinslide comes with enough inserts to increase or decrease the vend price by \$.50. If a higher or lower vend price is desired, more functional or blank inserts are necessary. Inserts may be ordered from Whirlpool Corporation only for models that come factory coinslide equipped, or coinslides manufactured by ESD. If the coinslide is other than Whirlpool factory equipped, additional inserts must be ordered from the coinslide manufacturer.

\$.25 US insert (Whirlpool Corp. part #8316265)

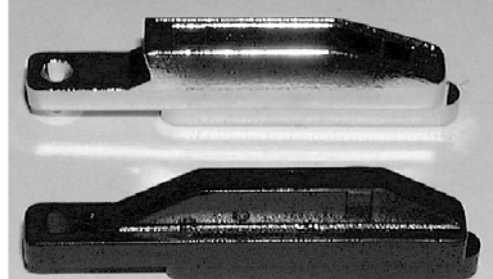

Insert blank (Whirlpool Corp. part # 8316264)

11. Turn the coinslide upside down and remove the three screws in the insert retaining plate.

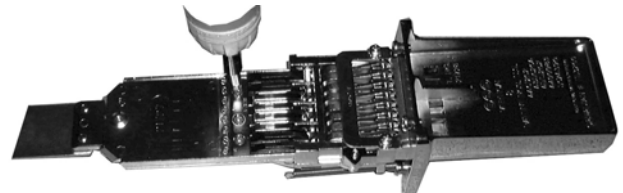

12. To increase the vend price, remove blank inserts and insert the metal functional inserts. To decrease the vend price, remove functional inserts and add blank inserts.

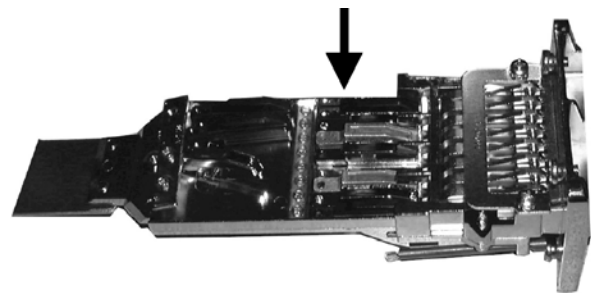

- Reinstall the three insert retaining plate screws, flip the coinslide over, and reinstall unused inserts (up to 4 count). Reinstall the spring bracket and retaining screw.

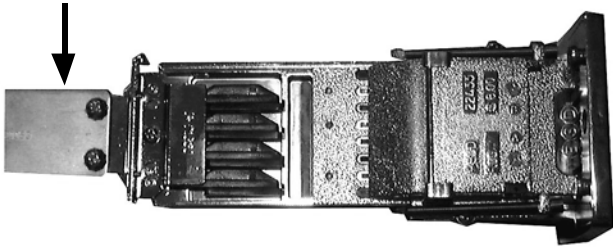

- Release the coinslide and reinstall the coinslide return spring(s) onto the spring bracket.
- Insert coins into the coinslide and test prior to installation of the coinslide into the washer.
- The coinslide may need to be partially pushed in to install it into the meter case (see photo A).
- Insert the coinslide and extension assembly into the meter case and push down slightly to lock into place (see photo B).

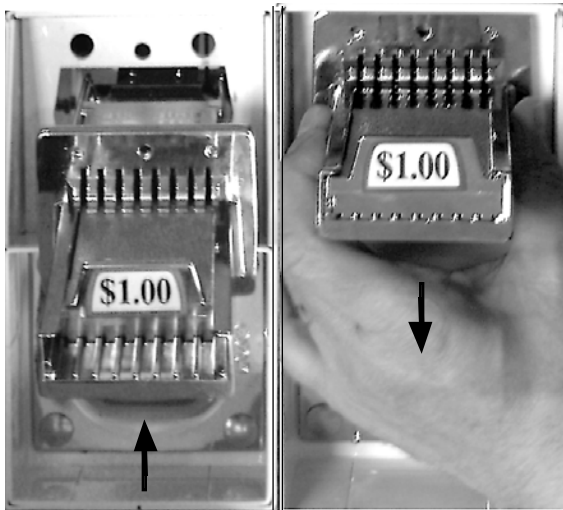

A

B

- Insert the coinslide retaining bolt from the meter case top access panel into the back of the coinslide, and hand tighten to start the threads prior to using any tools to avoid stripping the coinslide or retaining bolt threads.

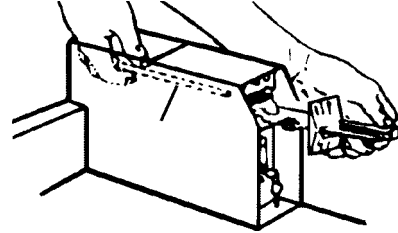

- Affix the proper new vend price sticker to the front of the coinslide.
- Reinsert the timer access panel and lock.
- Plug in washer or reconnect power.
- Insert coins to insure the cycle starts.
- Insert the coin box into the meter case lower opening. The coin box can be loosened or tightened by adjusting the four corner screws inside the coin box.



- The completed installation is pictured from the top and the side of the meter case.

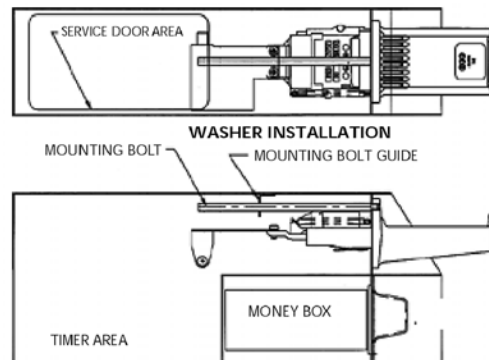

SMART CARD INSTALLATION

⚠ WARNING



Electrical Shock Hazard
Disconnect power before servicing.
Replace all parts and panels before operating.
Failure to do so can result in death or electrical shock.

1. Unplug washer or disconnect power.
2. Remove meter case top access panel.
3. Remove any existing money acceptor if currently installed.
4. Remove the coinslide adapter plate from the meter case by removing the three hex mounting nuts; one from the top on the coin vault opening and two from the front top of the timer access opening.
5. Release the coin funnel from the meter case by releasing the plastic retaining clips and turning the funnel up as shown, then remove the funnel through the timer access panel.

Adapter Plate

Coin Funnel

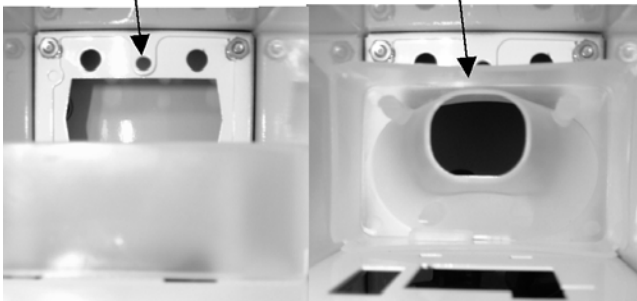

6. Unpack the SMART card reader and wiring harness included with the card reader kit.

7. Remove the two T-15 Torx screws from the bottom of the control panel console and swing the console open into the service position.

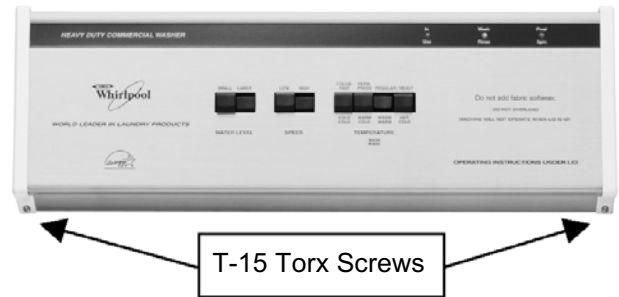

8. Thread the wiring harness from the console into the meter case through the harness opening in the rear of the meter case.
9. Thread the wiring harness, included with the SMART card kit, through the opening in the left rear of the meter case into the console.

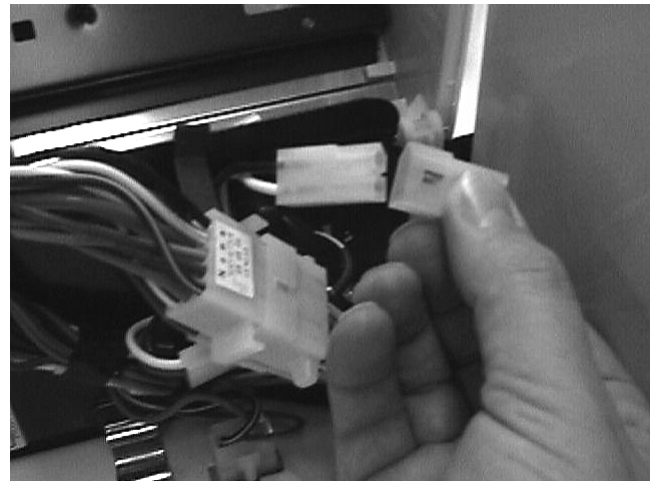

10. Connect the harness to the 2-pin auxiliary power connector in the console.
11. Attach any additional components or connections to the washer, as specified in the SMART card manufacturer's installation instructions.

12. Close the console and replace the two Torx T-15 screws.
13. Install the card reader into the upper meter case opening. Push the card reader into the meter case, then lock it by pushing down slightly.

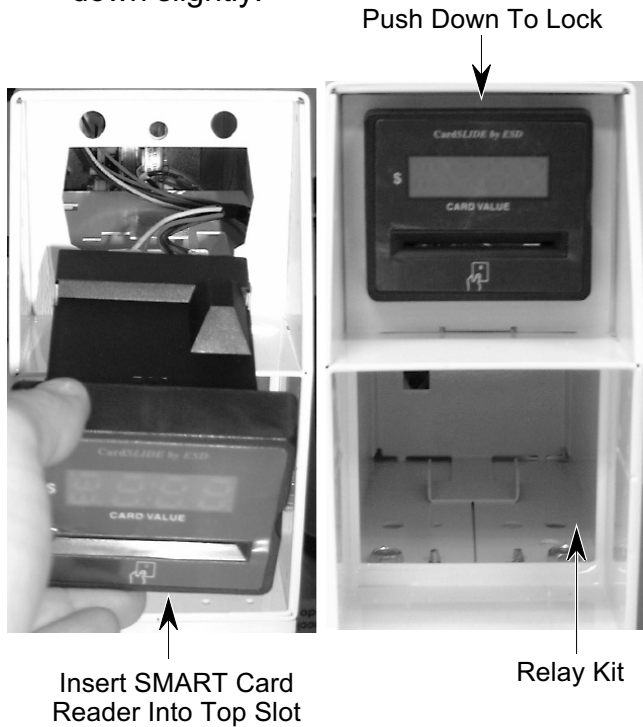

14. Install the card reader retaining screw included with the kit, or a standard coinslide retaining bolt.
15. Reconnect power and set the vend price on the set up card.
16. Snap the coin box cover plate over the coin box opening.
17. Reinstall the meter case top access panel.
18. Insert the set up card into the card reader and verify vend settings match on the washer display and the card reader display.
19. Insert the user card to verify proper operation.

THEORY OF OPERATION

The Whirlpool High Efficiency Top Load Commercial Washer is the first top-loading washing machine to receive *Energy Star*[®] designations.



Look for the label

The *Energy Star*[®] program was established by the U.S. Department of Energy and the U.S. Environmental Protection Agency to help consumers quickly and easily identify products that save energy and help protect the environment. As an *Energy Star*[®] partner, Whirlpool Corporation has determined that products bearing this mark meet the *Energy Star*[®] guidelines for energy efficiency.

The High Efficiency Top Load Commercial Washer is designed to successfully wash clothes with up to approximately 28% less water per load*.

The washer uses a series of “spray rinses” rather than a “deep rinse,” as in other conventional washers. As water is sprayed onto the spinning clothes, they become saturated with water and detergent. The rinse water is then extracted from the spinning clothes, and diverted back into the basket, where it is recirculated, and sprayed back onto the spinning clothes in the sequence specified in the cycle progression chart, shown on page 3-3.

* Source: Battelle Pacific Northwest Laboratory-testing compares the High Efficiency Top Load Commercial Washer to a General Electric baseline top-loading washer.

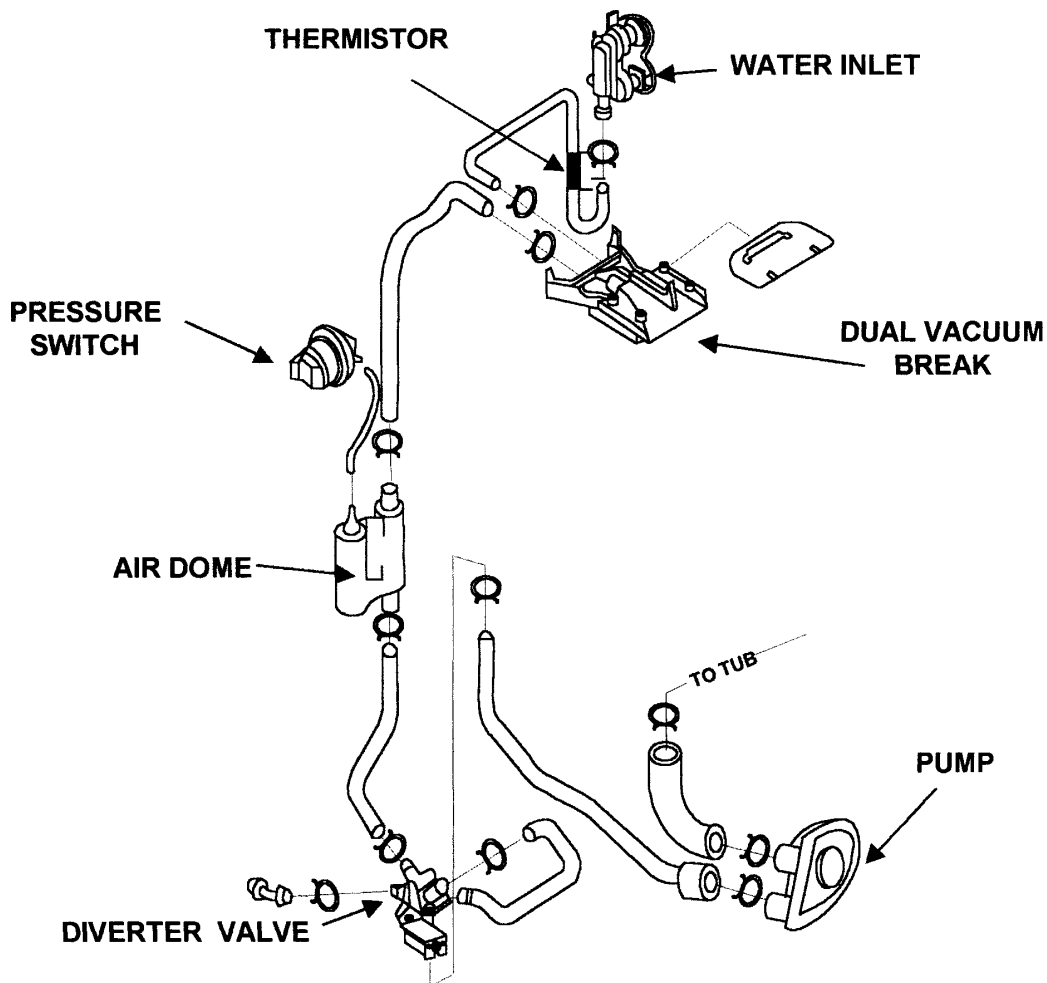

Two water levels allow efficient use of the washer for both large and small loads. Four wash/rinse temperature combinations help to provide the right washing conditions for a wide range of fabrics: Heavy (Hot/Cold), Regular (Warm/Warm), Permanent Press (Warm/Cold), and Colorfast (Cold/Cold).

The High Efficiency Top Load Commercial Washer has the following unique components:

- Automatic Temperature Control.
- A recirculation system (dual vacuum break, diverter valve, second and third pressure switches, and an extra air dome).
- A total of three pressure switches:
 - The first to control the high water level.
 - The second for the low water level.
 - The third to control water level during the fill and recirculate portion of the spray rinse.

- An additional splash shield on the tub ring, and a splash shield on the washer top, prevent water and suds from spraying up over the tub ring onto the floor.

During the cycle, the water level switch for the selected water level (high or low) must be in the empty position in order for the rinse switch to be powered (see the illustration below).

The High Efficiency Top Load Commercial Washer uses four short duration fresh spray rinses in place of a standard wash cycle drain and spin. During the rinse portion of the cycle, the washer has 5 recirculating fresh spray rinses in place of a deep rinse. Next is a final recirculation only rinse for 1.5 minutes prior to final spin.

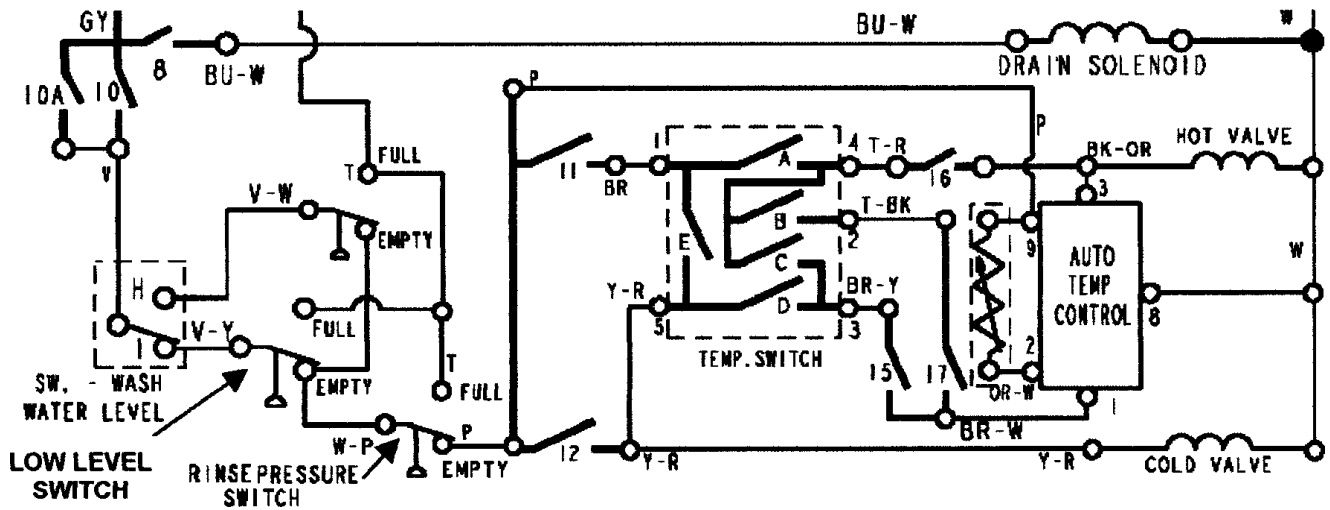

CYCLE PROGRESSION CHART

TYPICAL TOP LOAD WASHER		CAW2762K		
	WASHER FUNCTION	COMPONENTS OPERATING	WASHER FUNCTION	COMPONENTS OPERATING
WASH	FILL	FILL VALVE	FILL	FILL VALVE, ATC*
	AGITATE	TIMER MOTOR, DRIVE MOTOR IN AGITATE DIRECTION	AGITATE	TIMER MOTOR, DRIVE MOTOR IN AGITATE DIRECTION
	DRAIN	TIMER MOTOR DRIVE MOTOR IN SPIN DIRECTION HIGH	ADVANCED SPRAY (RECIRCULATE VALVE POWERED OPEN TO ALLOW DRAINING)	DRIVE MOTOR LOW SPEED IN SPIN DIRECTION, TIMER MOTOR, DRAIN SOLENOID, FILL VALVE ON FOR 4 SHORT DURATION ATC* CONTROLLED SPRAYS
	PAUSE (3-5 SECONDS FOR NEUTRAL DRAIN LOCK TO SPIN)	TIMER MOTOR		
	SPIN	TIMER MOTOR DRIVE MOTOR IN SPIN DIRECTION HIGH	DRAIN (RECIRCULATE VALVE POWERED OPEN TO ALLOW DRAINING)	TIMER MOTOR, DRIVE MOTOR LOW SPEED IN SPIN DIRECTION, DRAIN SOLENOID
RINSE	FILL	FILL VALVE	PAUSE (30 SECONDS TO REDUCE SUDS)	TIMER MOTOR
			ATC* FILL/ RECIRCULATE SPIN (30 SECONDS)	DRIVE MOTOR HIGH SPEED IN SPIN DIRECTION, TIMER MOTOR, RINSE LIGHT, ATC*, FILL VALVE (UNTIL SPRAY TIME ENDS OR RECIRCULATE LEVEL FULL)
	RINSE (AGITATE)	TIMER MOTOR DRIVE, MOTOR IN AGITATE DIRECTION	DRAIN/SPIN	DRIVE MOTOR HIGH SPEED IN SPIN DIRECTION, TIMER MOTOR, DRAIN SOLENOID, RINSE LIGHT
	DRAIN	TIMER MOTOR DRIVE MOTOR IN SPIN DIRECTION HIGH	ATC* FILL/ RECIRCULATE SPIN (30 SECONDS)	DRIVE MOTOR HIGH SPEED IN SPIN DIRECTION, TIMER MOTOR, RINSE LIGHT, ATC*, FILL VALVE (UNTIL SPRAY TIME ENDS OR RECIRCULATE LEVEL FULL)
	PAUSE (3-5 SECONDS FOR NEUTRAL DRAIN LOCK TO SPIN)	TIMER MOTOR	DRAIN/SPIN (90 SECONDS)	DRIVE MOTOR HIGH SPEED IN SPIN DIRECTION, TIMER MOTOR, DRAIN SOLENOID, RINSE LIGHT
	SPIN	TIMER MOTOR DRIVE MOTOR IN SPIN DIRECTION HIGH	ATC* FILL/ RECIRCULATE SPIN (30 SECONDS)	DRIVE MOTOR HIGH SPEED IN SPIN DIRECTION, TIMER MOTOR, RINSE LIGHT, ATC*, FILL VALVE (UNTIL SPRAY TIME ENDS OR RECIRCULATE LEVEL FULL)
			DRAIN/SPIN (90 SECONDS)	DRIVE MOTOR HIGH SPEED IN SPIN DIRECTION, TIMER MOTOR, DRAIN SOLENOID, RINSE LIGHT
			ATC* FILL/ RECIRCULATE SPIN (30 SECONDS)	DRIVE MOTOR HIGH SPEED IN SPIN DIRECTION, TIMER MOTOR, RINSE LIGHT, ATC*, FILL VALVE (UNTIL SPRAY TIME ENDS OR RECIRCULATE LEVEL FULL)
			DRAIN/SPIN (90 SECONDS)	DRIVE MOTOR HIGH SPEED IN SPIN DIRECTION, TIMER MOTOR, DRAIN SOLENOID, RINSE LIGHT
			ATC* FILL/ RECIRCULATE SPIN (2 MINUTES)	DRIVE MOTOR HIGH SPEED IN SPIN DIRECTION, TIMER MOTOR, RINSE LIGHT, ATC*, FILL VALVE (UNTIL SPRAY TIME ENDS OR RECIRCULATE LEVEL FULL)
			RECIRCULATE/SPIN (90 SECONDS)	DRIVE MOTOR HIGH SPEED IN SPIN DIRECTION, TIMER MOTOR, RINSE LIGHT
			DRAIN/SPIN (5 MINUTES)	DRIVE MOTOR HIGH SPEED IN SPIN DIRECTION, TIMER MOTOR, DRAIN SOLENOID, SPIN LIGHT

* ATC operates only when a Warm or Hot cycle temperature selection is made to insure hot water temperature is 100°F, and warm water is 70°F, both maintained within ±5°F.

— NOTES —

COMPONENT ACCESS

This section instructs the technician on how to service each component inside the High Efficiency Top Load Commercial Washer. The front washer components and their locations are shown below. The High Efficiency components are shown on page 4-23.

COMPONENT LOCATIONS

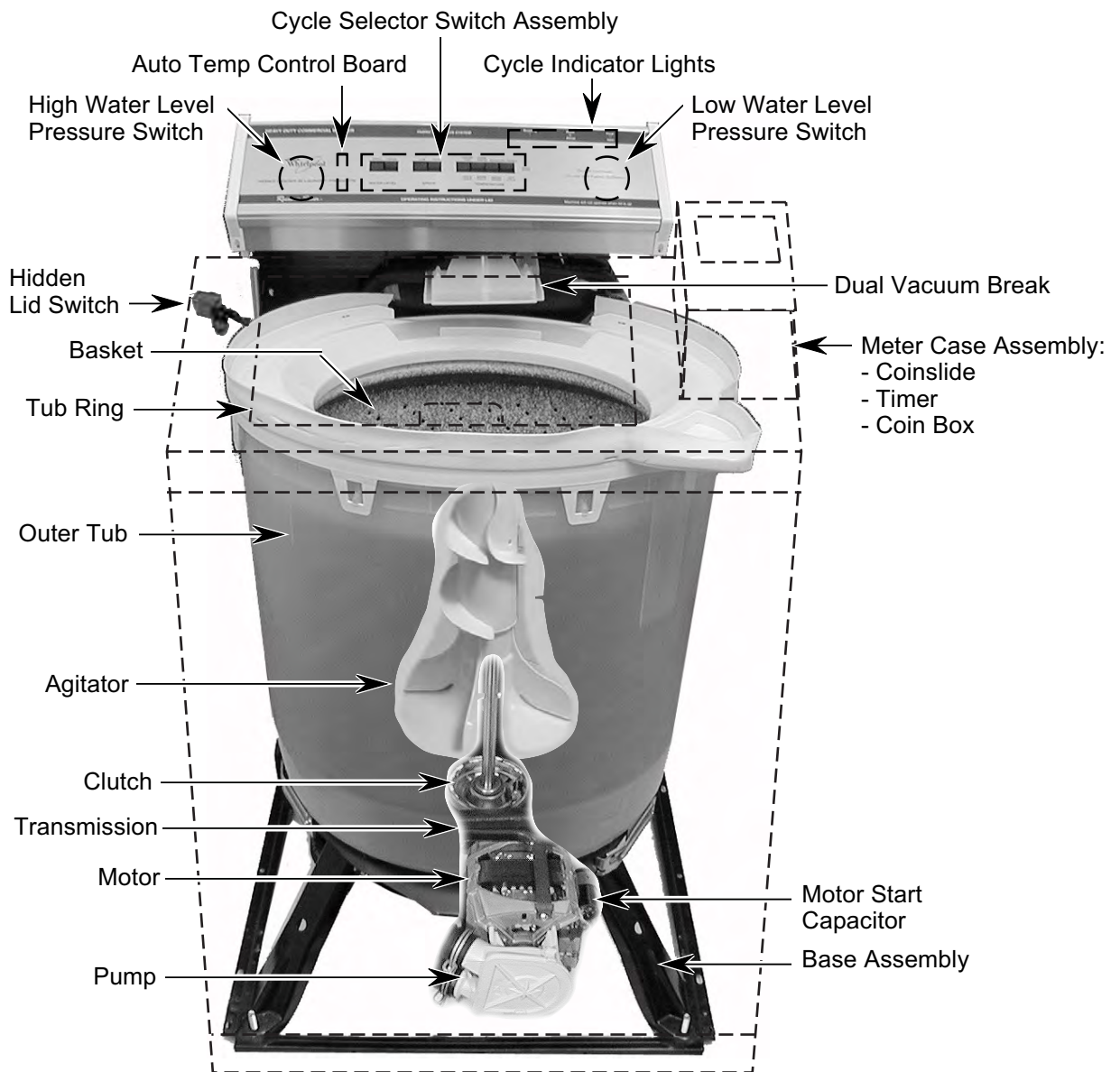

REMOVING THE CONSOLE COMPONENTS

⚠️ WARNING



Electrical Shock Hazard

Disconnect power before servicing.

Replace all parts and panels before operating.

Failure to do so can result in death or electrical shock.

The console consists of the following serviceable components:

- Water Level Pressure Switches
- Cycle Indicator Lights (3)
- Cycle Selector Switch Assembly
- Auto Temp Control Board
- End Cap

1. Unplug washer or disconnect power.
2. Remove the two T-15 Torx screws from the console.

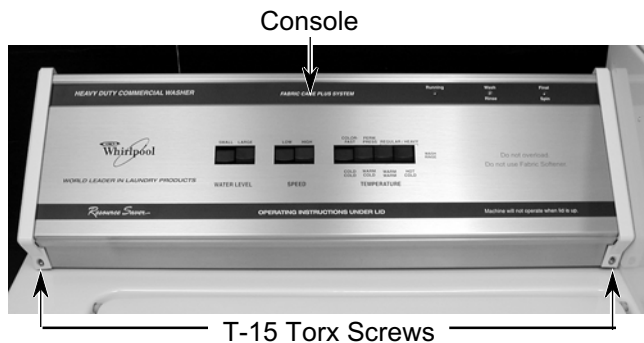

3. Rotate the console back on its two hinges to the service position.

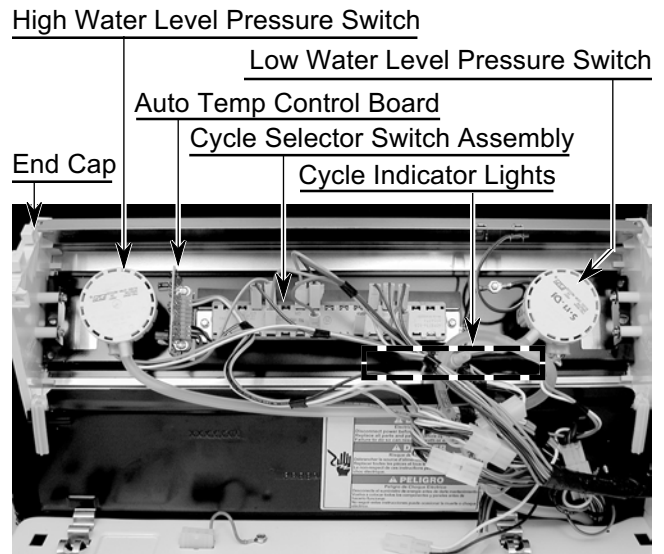

4. To remove a water level pressure switch:

- a) Push in on the locking arm and rotate the switch in either direction, until the square extrusion on the switch aligns with the cutout in the console support bracket, and remove the switch.

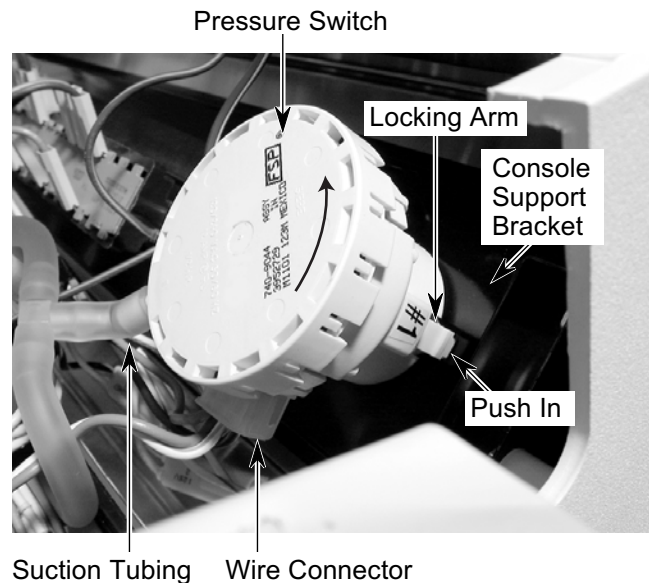

- b) Disconnect the suction tubing from the switch.
- c) Pull out on the locking arm of the wire connector to release it, and pull the connector off the switch pins.

5. **To remove a cycle indicator light:**

NOTE: All three indicator lights must be removed and replaced as an assembly.

- a) Press in slightly on the body and slide it off the lens.
- b) Disconnect the 6-pin connector from the main harness.

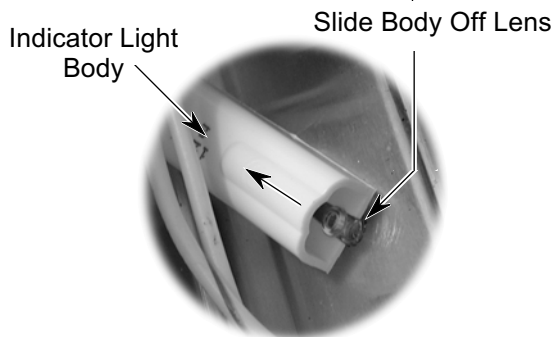
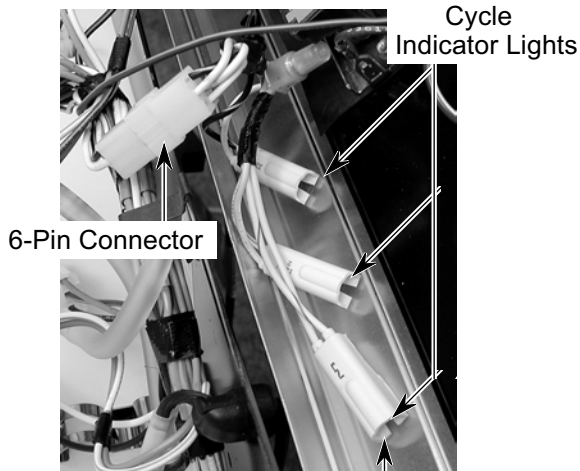

6. **To remove the cycle selector switch assembly:**

- a) Disconnect the 11 wire connectors and the green ground wire from the switch terminals.
- b) Remove the two hex-head screws.
- c) Remove the switch from the console.

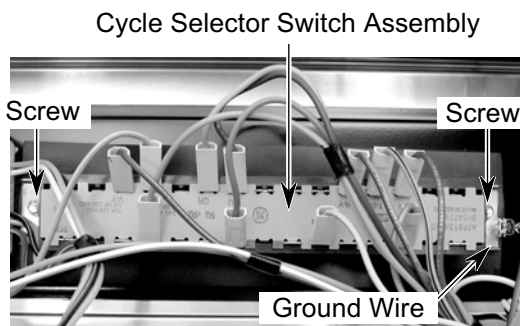

! WARNING

Electrical Shock Hazard Connect green ground wire to ground terminal. Failure to do so can result in death or electrical shock.

- d) Prior to reinstallation, make sure the switch seal is clean and flat between the switch face and the console.
- e) Reinstall the switch in the console and tighten the two hex-head screws.
- f) Reconnect the 11 wire connectors and the green ground wire terminal to the same locations from which removed.

NOTE: Refer to the Electrostatic Discharge information on page 1-2 before performing the next step.

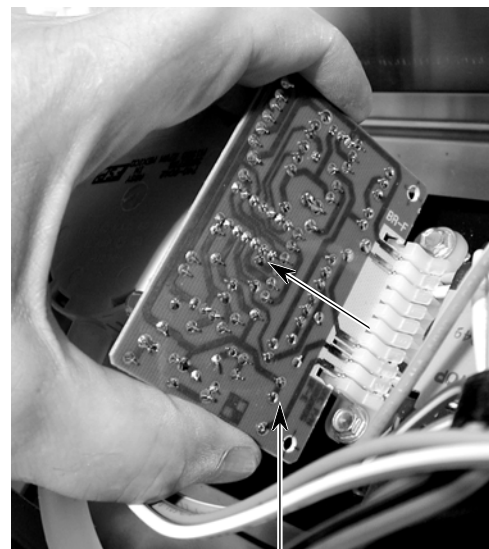
7. **To remove the auto temp control board,** pull the board out of the connector. Handle the board only by the edges.



Auto Temp Control Board

Continued on the next page.

8. **To remove an end cap from the console:**

- a) Remove the hex-head screw from the back of the end cap.

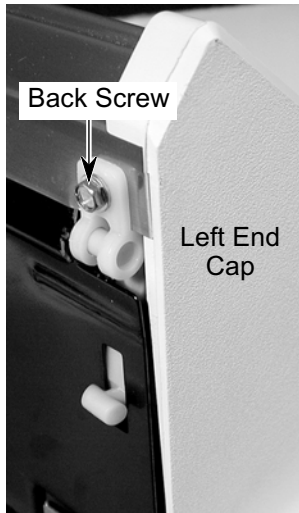

- b) Remove the two hex-head screws from the console support bracket, and slide the end cap off the end of the panel.



- c) If a mounting stud is not installed on the new end cap, remove the stud from the old cap, and install it on the new one.

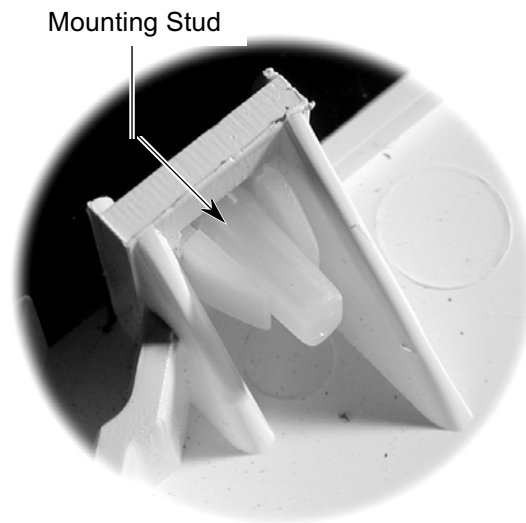
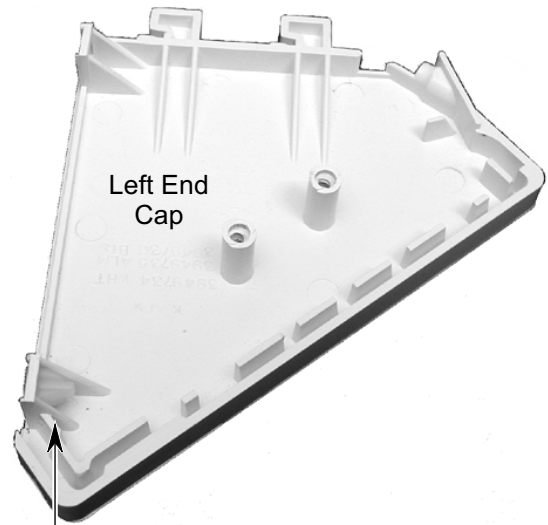

REMOVING THE METER CASE ASSEMBLY COMPONENTS

⚠️ WARNING



Electrical Shock Hazard
Disconnect power before servicing.
Replace all parts and panels before operating.
Failure to do so can result in death or electrical shock.

The meter case assembly consists of the following serviceable components:

- The Money Acceptor
- Timer
- Meter Case
- Coin Box

1. Unplug washer or disconnect power.
2. Unlock the service access door and remove it from the top of the meter case.

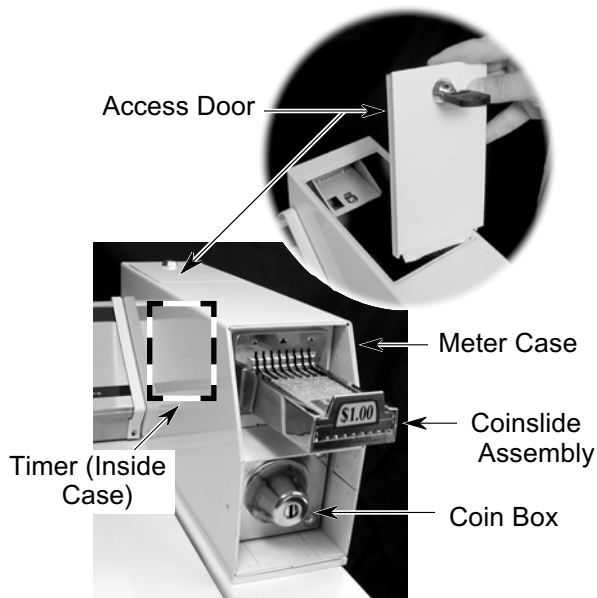

3. To remove the coinslide assembly:
 - a) Using a 5/16" socket, unscrew the retaining bolt from the coinslide, and remove the bolt from inside the meter case.

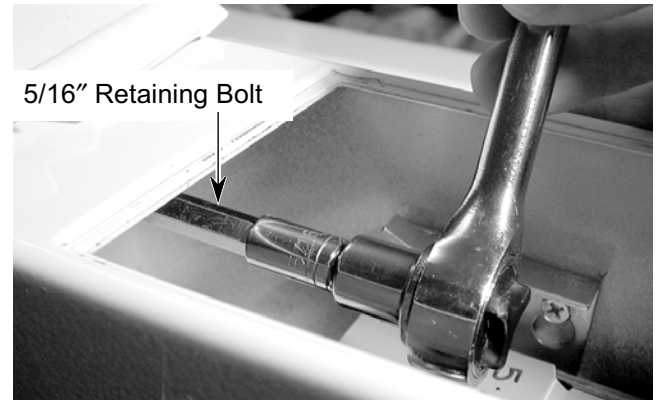

- b) Lift the coinslide to release it from the holes in the meter case, and pull it forward out of the meter case.



Continued on the next page.

NOTE: A coinslide is the most common money acceptor, and is referenced in this procedure.

4. To remove the timer:

- a) Using a 5/16" socket, unscrew the retaining bolt from the coinside, and remove the bolt from inside the meter case.

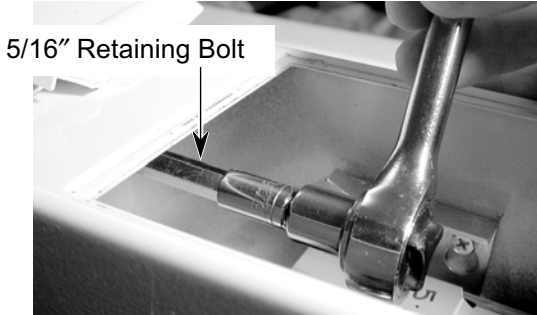

- b) Loosen (do not remove) the two timer bracket screws from the inside of the meter case.

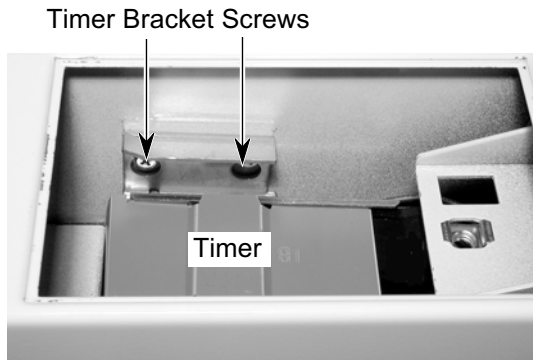

- c) Unplug the two 9-pin timer wiring harness connectors at the console.
- d) Disconnect the main harness connector from the cycle selector switch assembly.

Cycle Selector Switch Connectors (9)



9-Pin Connectors

- e) Lift the timer assembly off the bracket screws and remove it from the meter case.

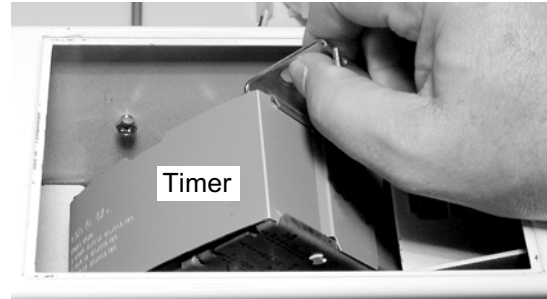

- f) Loosen the two setscrews on the timer clutch hub and pull the timer clutch assembly off the timer shaft.

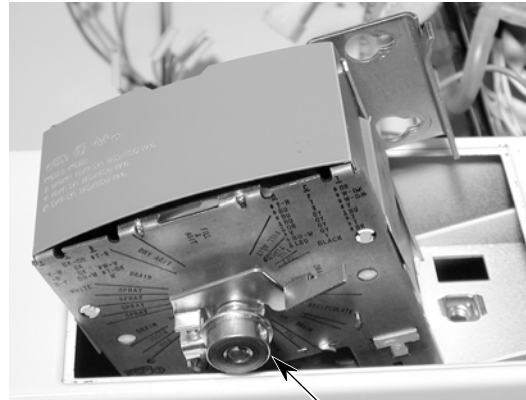

Timer Clutch Hub With 2 Setscrews

- g) Remove the two 5/16" hex-head screws and ground wire from the timer bracket and remove the bracket.
- h) Disconnect the two wire connectors from the timer.

5/16" Hex-Head Screws & Ground Wire

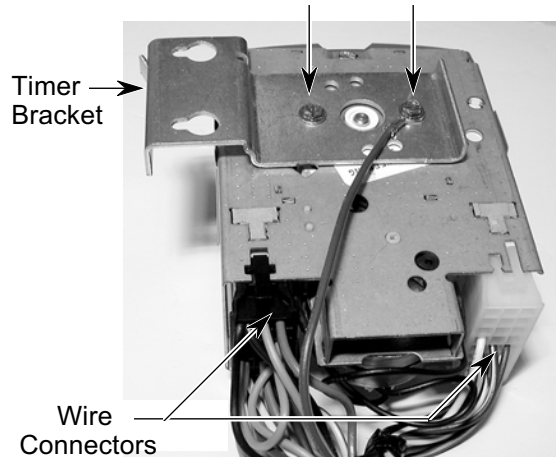

⚠️ WARNING



Electrical Shock Hazard
Connect green ground wire to ground screw.
Failure to do so can result in death or electrical shock.

- i) To reinstall the timer, reconnect the two wiring connectors to the timer.
- j) Reinstall the ground wire onto the timer bracket.
- k) Reinstall the timer bracket onto the timer, and secure using the two 5/16" hex screws.
- l) Reinstall the timer clutch assembly onto the timer shaft, making sure the top of the timer clutch hub is even with the top of the timer shaft.
- m) Position the indicated setscrew over the flat portion of the timer shaft, as shown in the photo below.
- n) Rotate the timer clutch assembly to the OFF position (shown on the timer case) before mounting the timer assembly into the meter case.

Timer Clutch Hub Even With Top Of Timer Shaft

Setscrew Over Flat On Shaft

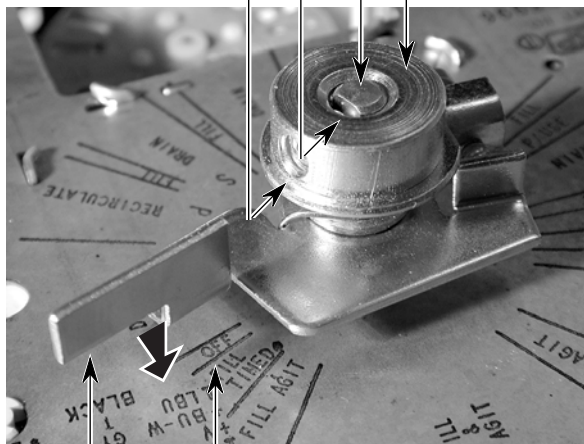

Clutch Assembly At OFF Position

5. To remove the meter case:

- a) Remove the coinslide assembly and the timer from the meter case (see pages 4-5 through 4-7 for the procedures).
- b) Unlock and remove the coin box.



- c) Unsnap the locking arms from the bottom of the coin funnel and remove the funnel from the meter case.
- d) Remove the 1/2" hex-head screws from the front and rear of the meter case, then lift the meter case off the washer, and remove it.

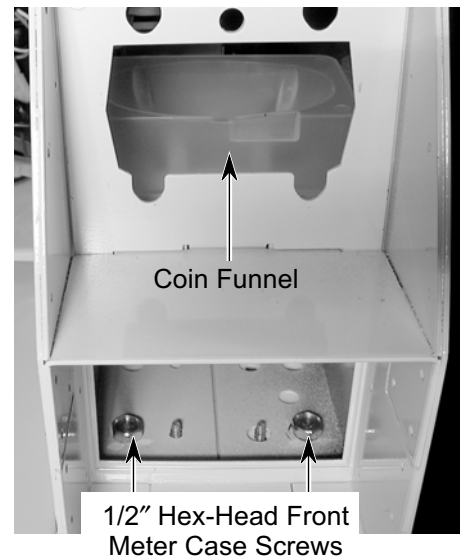

REASSEMBLY NOTE: Operate the coinslide to make sure that the coinslide extension engages the timer clutch arm and starts the cycle.

REMOVING THE HIDDEN LID SWITCH

⚠️ WARNING



Electrical Shock Hazard
Disconnect power before servicing.
Replace all parts and panels before operating.
Failure to do so can result in death or electrical shock.

1. Unplug washer or disconnect power.

2. Position the console to its service position (see page 4-2 for the procedure).
3. Disconnect the main harness connector from the hidden lid switch connector.
4. Remove the 5/16" hex-head screw from the hidden lid switch ground wire.
5. Press the locking arm on the lid switch connector to release it, and push the connector out of the cutout.
6. Remove the two hidden lid switch mounting screws.

NOTE: If necessary, the washer can be operated in all cycles with the cabinet removed. Install a jumper wire in the lid switch harness connector as shown.

IMPORTANT: Use extreme caution when operating the washer with the cabinet removed.

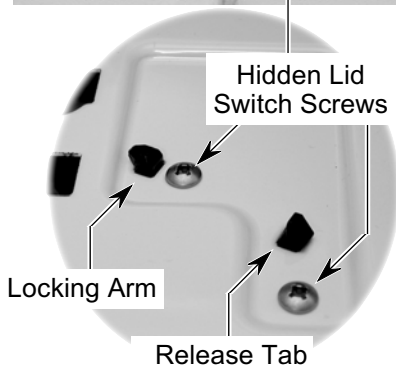
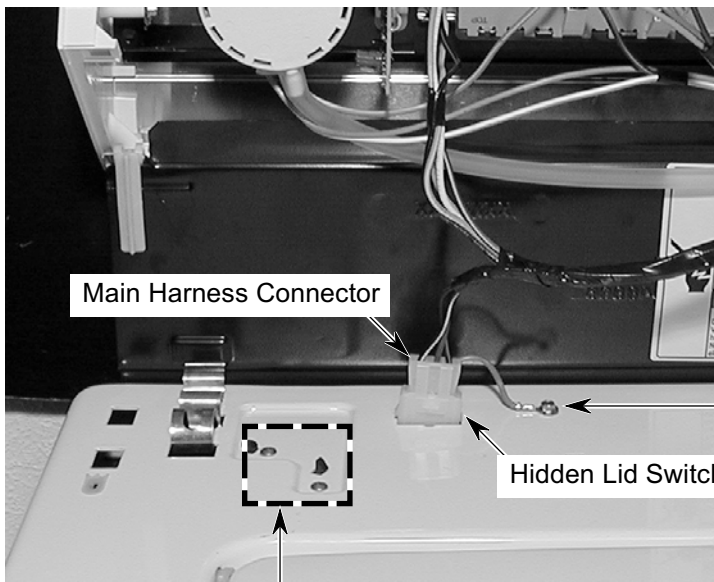
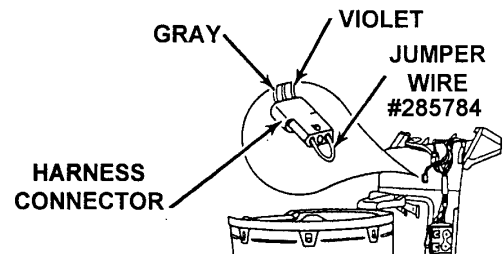

7. Raise the washer lid.
8. From the left side of the unit, reach between the cabinet top and the tub ring and grasp the hidden lid switch. With your other hand, press the release tab on the hidden lid switch on the cabinet top, and remove the switch.

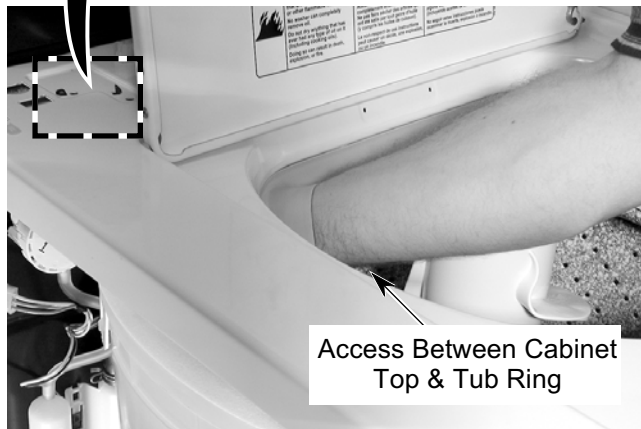

! WARNING

<p>Electrical Shock Hazard Connect green ground wire to ground screw. Failure to do so can result in death or electrical shock.</p>

9. To reinstall the switch, mount the switch into the washer top by first inserting the locking arm toward the back of the washer.
10. Push the release tab through the forward hole in the washer top.
11. Insert the ground wire through the harness connector opening in the washer top.
12. Insert the harness connector into the harness connector opening and lock into place.
13. Reinstall the 5/16" hex-head screw securing the lid switch ground wire to the washer top.
14. Reinstall the two switch mounting screws.

REMOVING THE PUMP, MOTOR START CAPACITOR, & MOTOR

⚠️ WARNING



Electrical Shock Hazard
Disconnect power before servicing.
Replace all parts and panels before operating.
Failure to do so can result in death or electrical shock.

1. Unplug washer or disconnect power.
2. Remove the two T-20 Torx screws from the bottom of the front panel.
3. To remove the front panel, pull the bottom forward to release it from the two top retaining clips, and remove the panel.

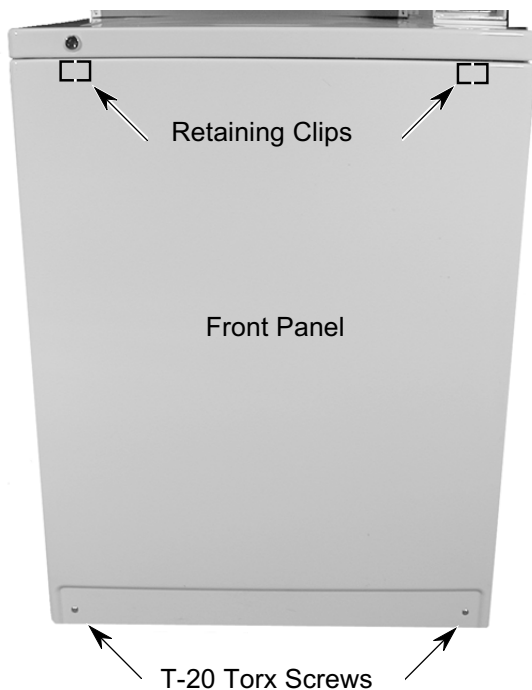

NOTE: The pump, motor start capacitor, and motor can more easily be accessed by tilting the washer back, or by laying it on its rear panel.

4. To remove the pump:

- a) Release the two pump spring clips and pull the pump away from the motor.
- b) Place a container near the two pump hoses to catch the water, then remove the clamps from the inlet and outlet hoses, and pull them off the pump.

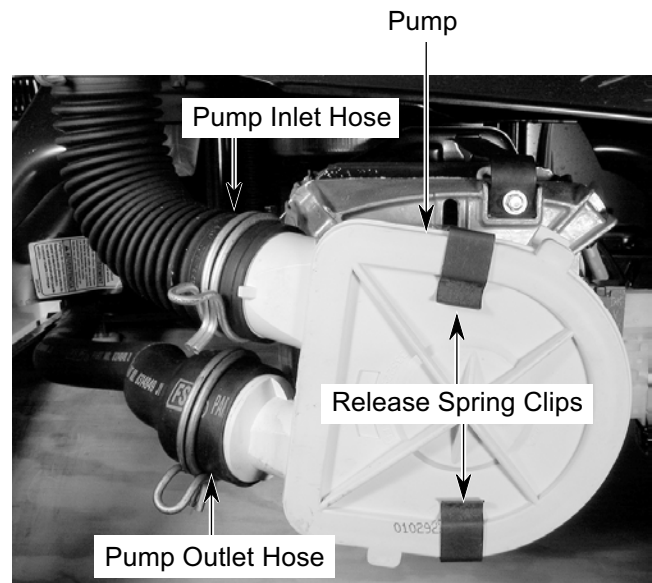
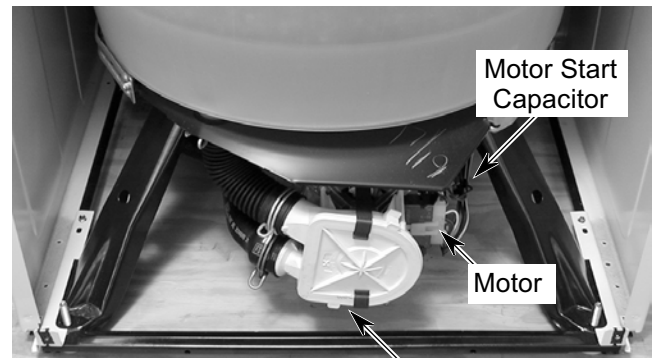

REASSEMBLY NOTE: Position the pump on the motor shaft with the feet in the bracket indents (circled below).

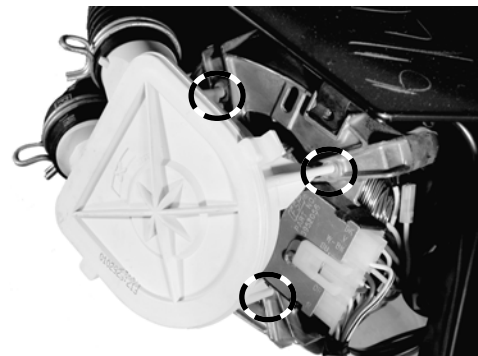

5. **To remove the motor start capacitor:**

- a) Disconnect the two wires from the motor start capacitor terminals.
- b) Loosen the hex-head screw on the capacitor clamp and slide the capacitor out.

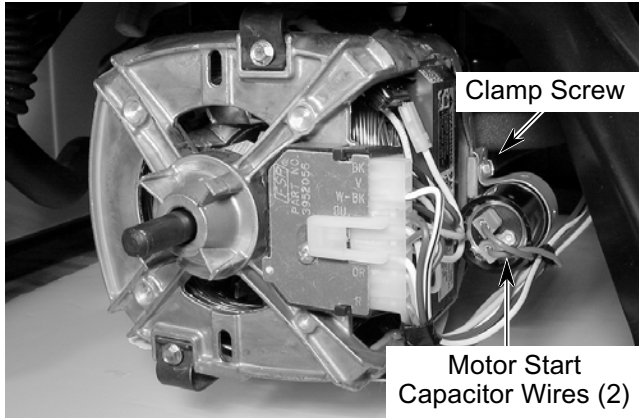

6. **To remove the motor:**

- a) Remove the pump (see step 4 for the procedure).
- b) Raise the locking arm and disconnect the wire connector from the motor.
- c) Disconnect the two wires from the motor start capacitor terminals.
- d) Remove the hex-head screw from each of the two motor mounting spring clips.

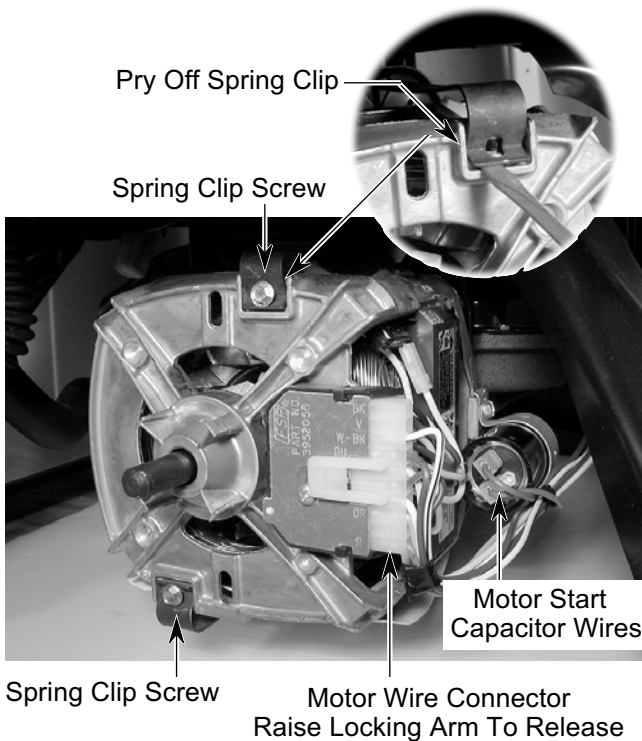

- e) Support the bottom of the motor with one hand to keep it from dropping, then pry the end of the top spring clip off the motor with a screwdriver, (see the round inset), and remove the lower spring clip.
- f) Lower the front of the motor until the motor coupler pins disengage from the motor coupler isolator, and remove the motor.



- g) Remove the following components from the motor:

- Motor Coupler
- Motor Start Capacitor & Clamp
- Rubber Motor Mounts (4)
- Cardboard Shield

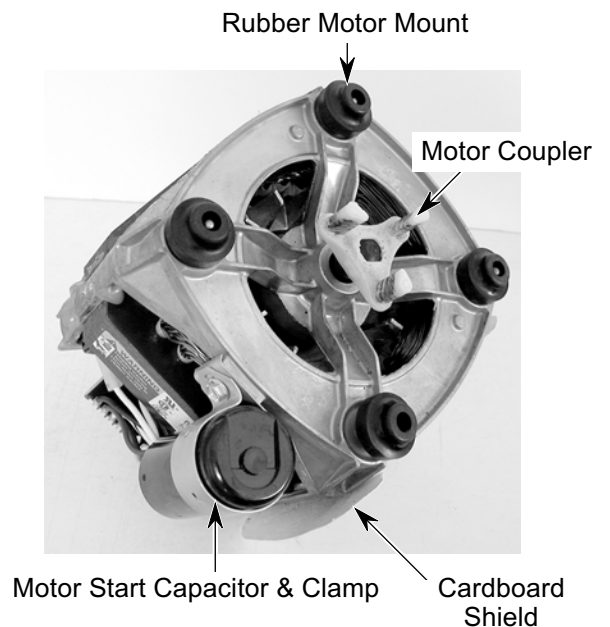

REMOVING THE AGITATOR & TRANSMISSION

⚠️ WARNING



Electrical Shock Hazard
Disconnect power before servicing.
Replace all parts and panels before operating.
Failure to do so can result in death or electrical shock.

1. Unplug washer or disconnect power.
2. **To remove the agitator:**
 - a) Unsnap the agitator cap from the agitator and remove it.



- b) Pull off the air dome cover and remove the rubber O-ring from inside the agitator.
- c) Remove the bolt from the agitator and lift the agitator out of the washer.

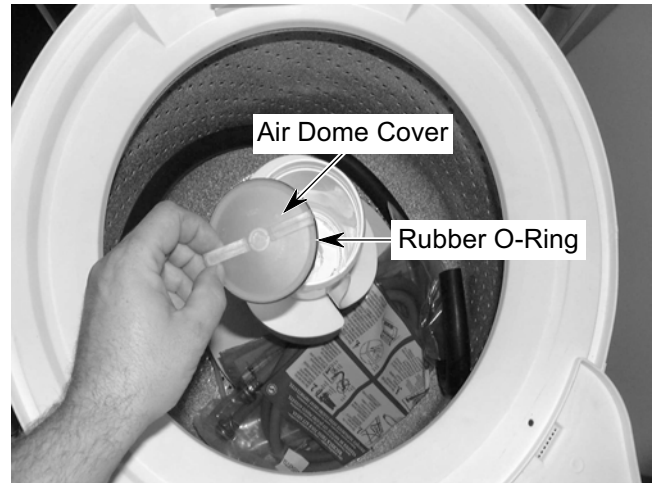

3. **To remove the transmission:**
 - a) Tape the washer lid closed.
 - b) Tilt the washer back at a 45° angle, or lay it on its back panel.
 - c) Unclip the two spring clips from the pump and remove the pump from the motor shaft (see step 4 on page 4-10).
 - d) Disconnect the motor wire connector and the two motor capacitor wires (see step 6 on page 4-11).
 - e) Disconnect the harness clip from the transmission.

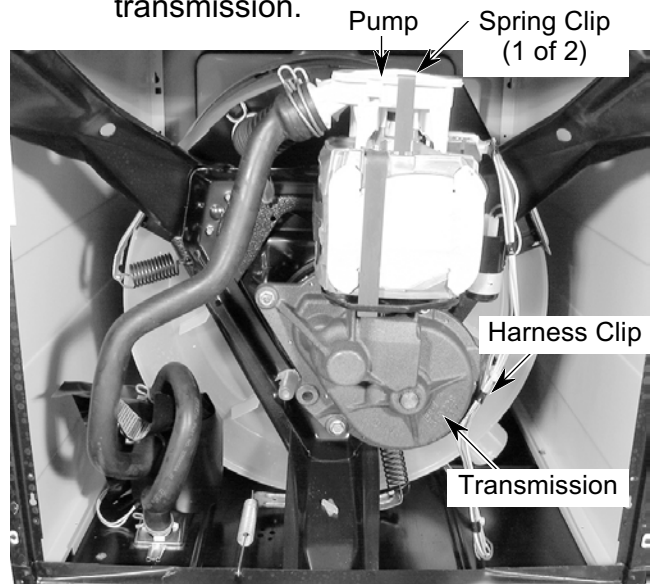

- f) Remove the three 1/2" bolts from the transmission and pull the transmission and motor assembly away from the washer.

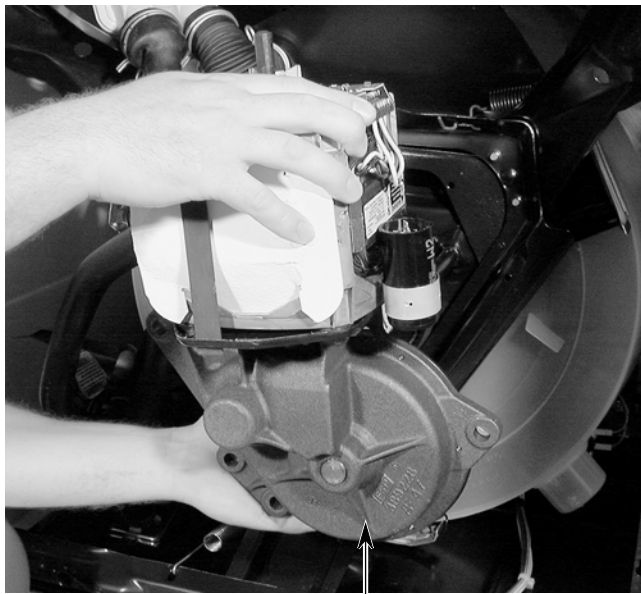
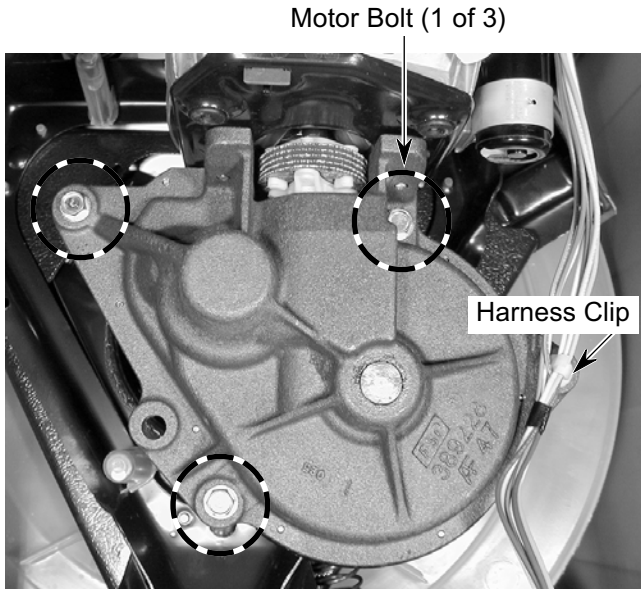

Pull Transmission & Motor From Washer

Refer to the photos in the next column.

- g) Remove the thrust washer from the agitator shaft.
- h) Use a screwdriver and unsnap the spring retaining clip from the agitator shaft.
- i) Use a screwdriver and unsnap the clutch retaining ring from the agitator shaft.

- j) Slide the clutch off the agitator shaft.
- k) Slide the anti-rattle clip off the agitator shaft.

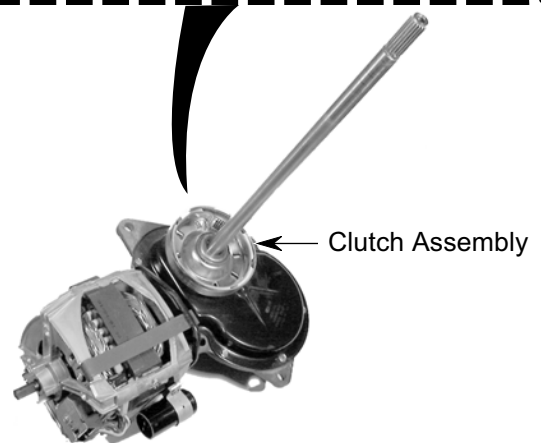
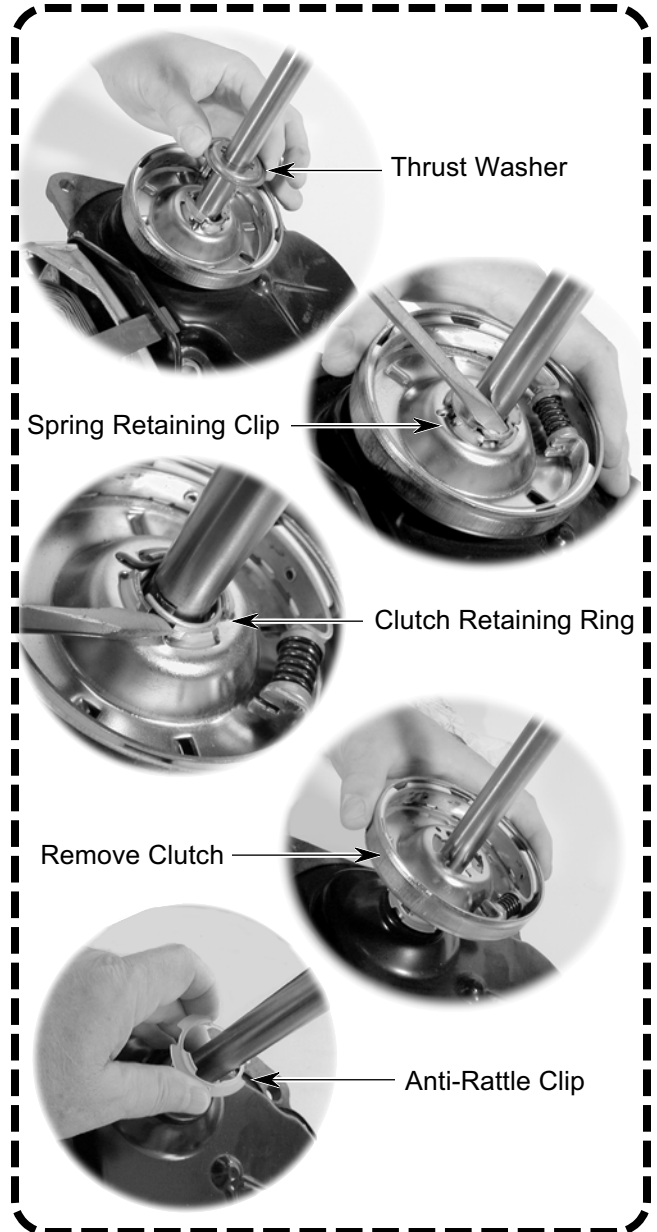

- l) Use a pair of pliers and remove the pad assembly from the clutch drum.

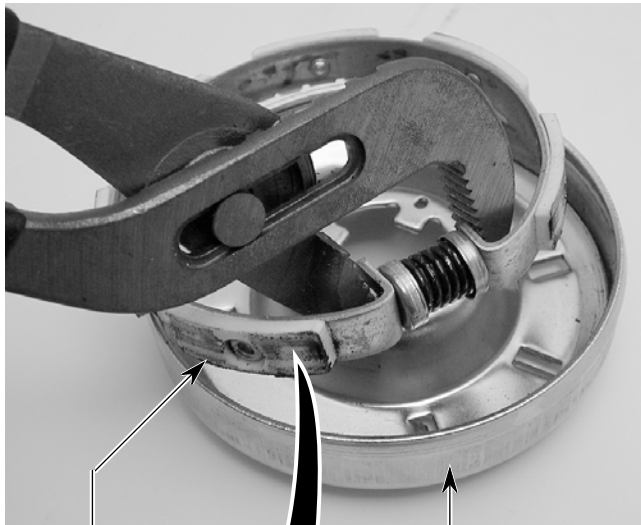

Clutch Pad Assembly

Drum

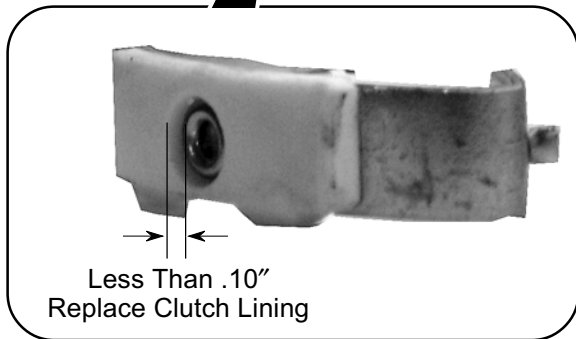

- m) Clean the inner surface of the clutch drum and the clutch pad assembly surfaces with an approved solvent, such as brake cleaner. Both assemblies must be free of dirt, oil, and grease so that the proper spin speed and water extraction may be achieved.
- n) Inspect the inside contact surface of the drum for scratch marks, or uneven wear. Inspect the clutch pad assembly for loose, or worn pads (see the inset photo above). If the distance between the clutch pad contact surface and the clutch pad rivet head is less than .10", replace the clutch assembly with part **#3953062**.

NOTE: The standard 3-pad clutch assembly cannot be substituted for the stock 6-pad clutch. The additional loads associated with the recirculating spray rinse system requires the 6-pad clutch for proper operation.

- o) Remove the motor from the transmission (see step 6 on page 4-11 for the procedure).
- p) Remove the two 1/2" hex-head bolts from the motor plate and remove the plate.

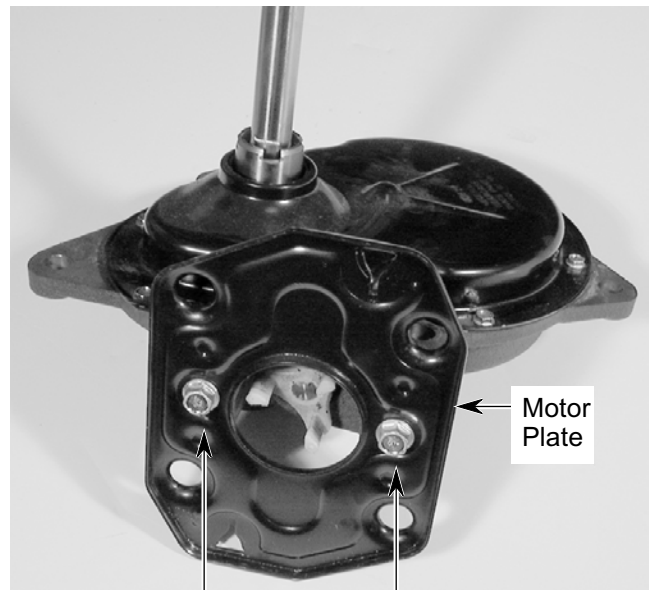

1/2" Hex-Head Bolts

Motor Plate

REMOVING THE CABINET ASSEMBLY

!WARNING



Electrical Shock Hazard
Disconnect power before servicing.
Replace all parts and panels before operating.
Failure to do so can result in death or electrical shock.

You will need to remove the cabinet assembly to service the following components:

- Dual Vacuum Break
- Tub Ring
- Basket
- Outer Tub
- Basket Drive Assembly
- Skate Plate & Suspension Pads
- Base Assembly

1. Unplug washer or disconnect power.
2. Position the console to its service position (see page 4-2 for the procedure).
3. Disconnect the two 9-pin wire harness connectors from the timer.
4. Disconnect the main harness from the hidden lid switch connector.

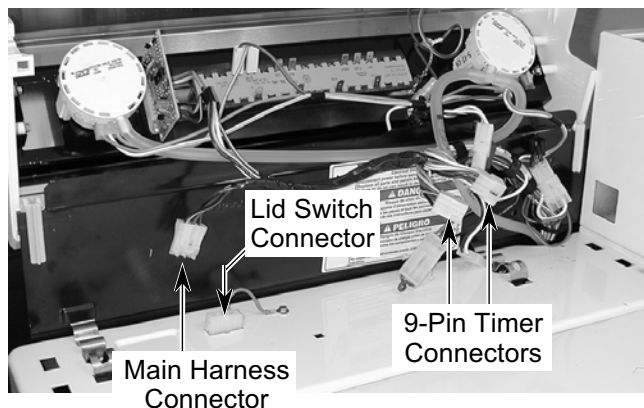

5. Use a screwdriver and unsnap the two cabinet spring clips from the cabinet top.

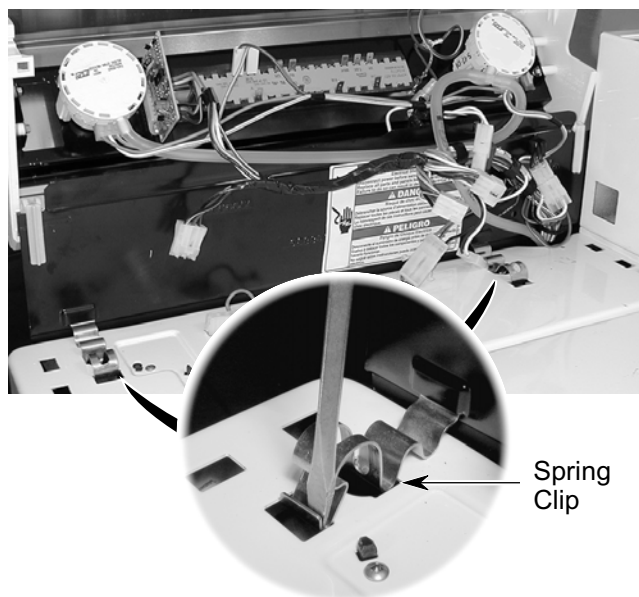

6. Use a screwdriver and unsnap the two cabinet side straps from the back of the washer.

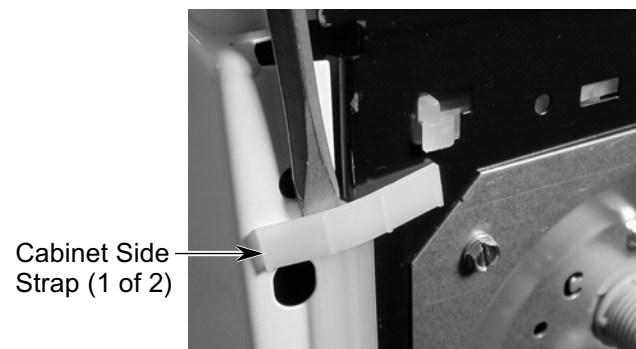

7. Remove the cabinet front panel (see page 4-10 for the procedure).
8. Remove the two bottom 5/16" side panel hex-head screws.



9. Lift the cabinet slightly and tip it forward on its front edges. **IMPORTANT:** The cabinet will not stand on its own in the upright position.



NOTE: When removing the cabinet, the basket must be pulled forward to avoid damage to the tub ring shield.

REASSEMBLY NOTE: When you reinstall the cabinet, make sure that the small alignment tabs at the front and rear of each side rail are fully upright, as shown below, and not bent over. Also make sure that the side rails are straight and not deformed, otherwise, the cabinet will not fit properly.

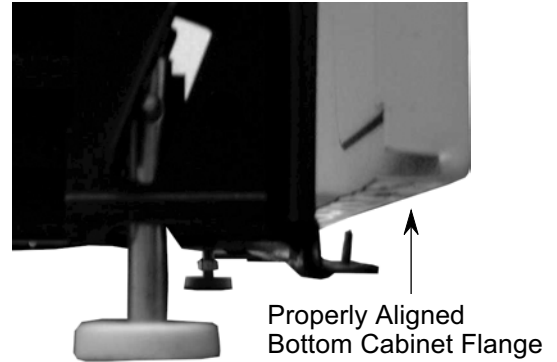
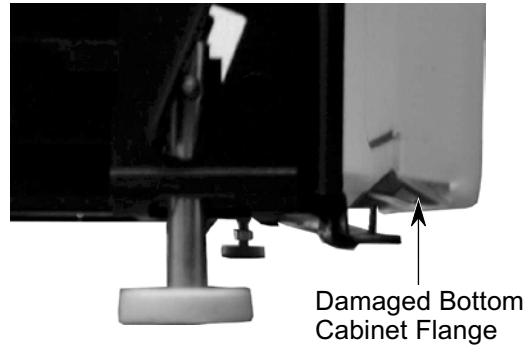
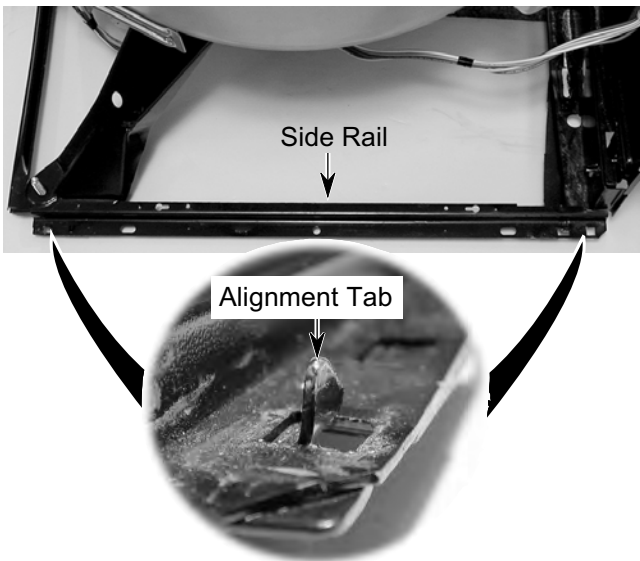

NOTE: Tension can be added to the cabinet clips to insure better frame-to-cabinet fit by adjusting the clips. Apply pressure in the direction of the arrow while holding the clip in the pliers.



REMOVING THE DUAL VACUUM BREAK

! WARNING



Electrical Shock Hazard
Disconnect power before servicing.
Replace all parts and panels before operating.
Failure to do so can result in death or electrical shock.

1. Unplug washer or disconnect power.
2. Remove the cabinet assembly from the washer (see page 4-15 for the procedure).



3. Pull sideways on the two mounting tabs of the dual vacuum break and remove them from the slots in the rear panel.

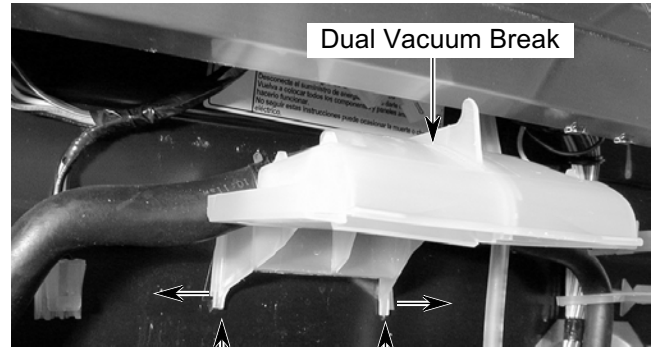

Mounting Tabs - Pull Sideways

4. Disconnect the two hoses from the dual vacuum break. Use a container to catch the water.



REMOVING THE TUB RING, BASKET, OUTER TUB, AND BASKET DRIVE ASSEMBLY

⚠️ WARNING



Electrical Shock Hazard
Disconnect power before servicing.
Replace all parts and panels before operating.
Failure to do so can result in death or electrical shock.

1. Unplug washer or disconnect power.
2. Remove the cabinet assembly (see page 4-15 for the procedure).
3. Remove the agitator (see step 2 on page 4-12 for the procedure).
4. **To remove the tub ring from the outer tub:**
 - a) Press down on the tub ring at each of the clips and pull the clips away from the outer tub catches.



- b) Lift the tub ring off the basket.

TUB RING REASSEMBLY NOTE: When you reinstall the tub ring, snap the tub ring clip with the narrow opening onto the catch on the outer tub first, then work around the ring to snap the remaining clips in place.

5. To remove the basket:

- a) Use a spanner wrench and remove the spanner nut from the drive block. Tap the spanner wrench with a hammer to loosen the nut while holding the basket.

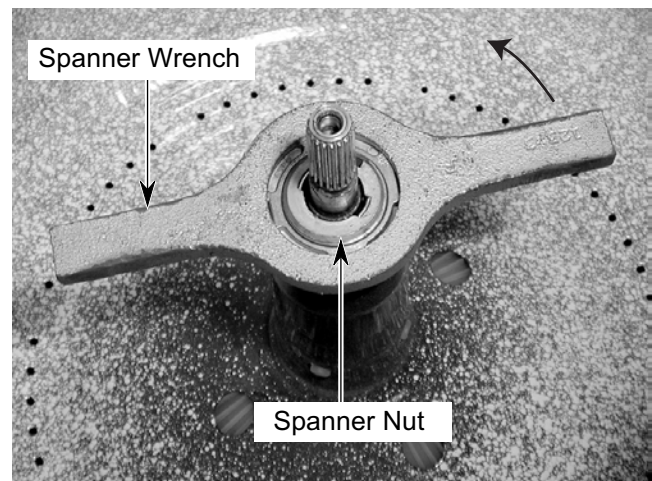

- b) Press down on one side of the basket with the heels of both hands and release the basket from the drive block, then lift the basket off the drive shaft, and out of the outer tub.

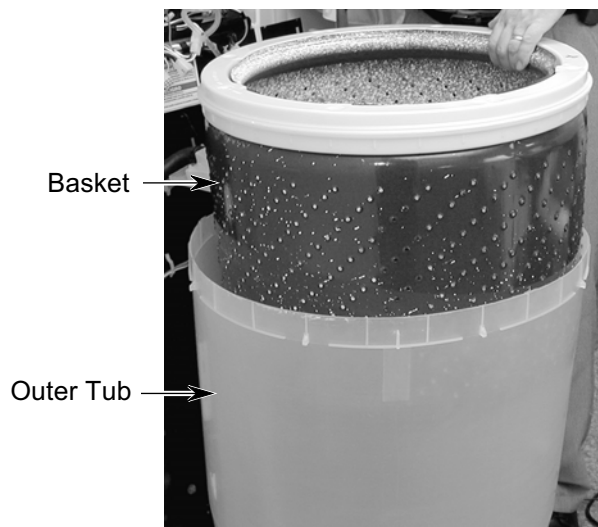

- c) Tap the bottom of the drive block with a hammer and remove it from the basket drive shaft.

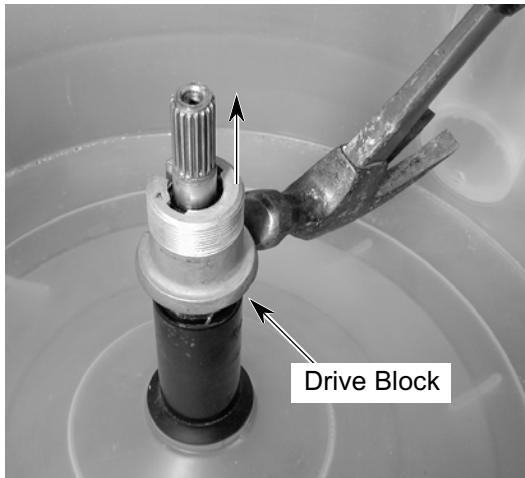

DRIVE BLOCK REASSEMBLY NOTE: When you reinstall the drive block on the basket drive, make sure that you align the two slots in the drive block with the corresponding tabs on the top of the basket drive shaft. If they are misaligned, the basket drive and drive block will fail.

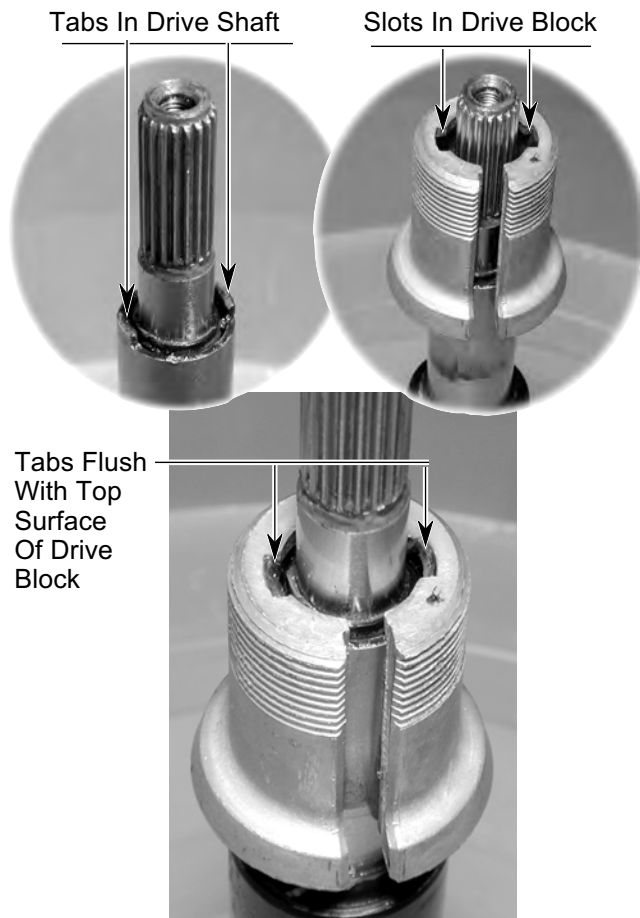

6. To remove the outer tub:

- a) Remove the end of the counterbalance spring from the hole in the frame. **NOTE:** The end of the spring is connected to the base assembly near the diverter valve. The washer in the photo below is shown laying on its rear panel.

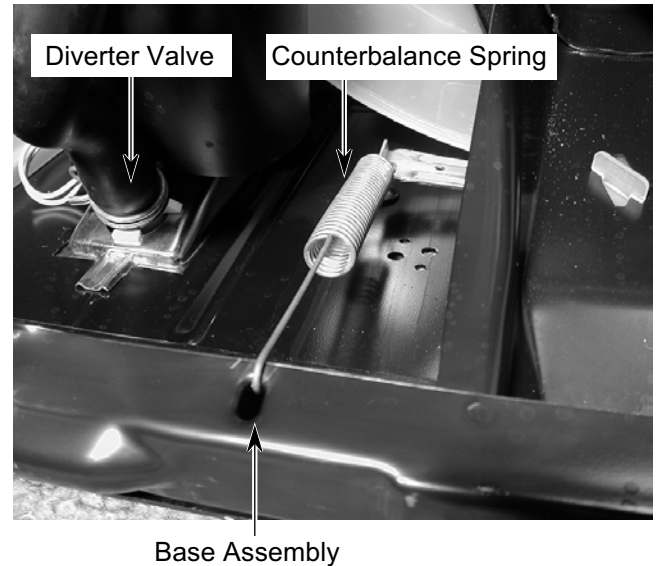

- b) Disconnect the end of the water level hose from the side of the outer tub.

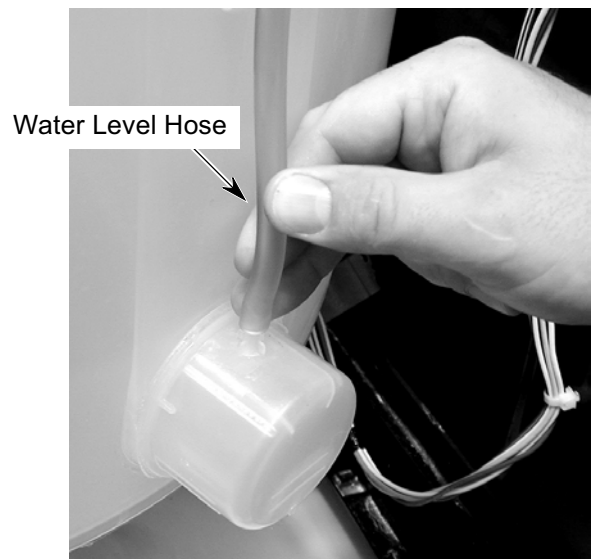

Continued on the next page.

- c) Remove the end of the tub-to-pump hose from the bottom of the outer tub.
- d) Remove the hex-head screw from each of the outer tub spring brackets.

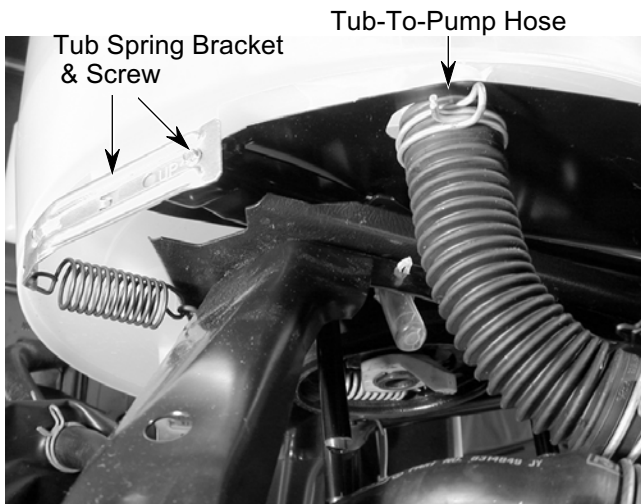

- e) Turn the outer tub while you lift it off the support assembly.

OUTER TUB REASSEMBLY NOTE: When you reinstall the outer tub, install the rear tub spring bracket first.

7. To remove the basket drive assembly:

- a) Remove the tub ring and the basket (see steps 4 and 5 on page 4-18 for the procedures).
- b) Remove the agitator and the transmission (see page 4-12 for the procedures).
- c) Turn the clutch engagement cam on the basket drive counterclockwise while pulling it toward you, and remove the basket drive from the support assembly.

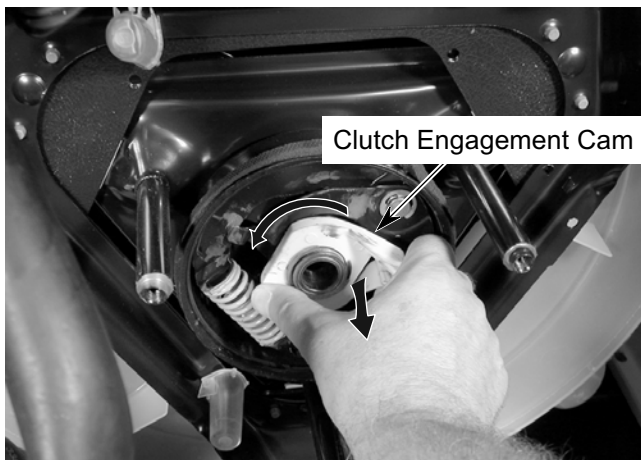

- d) Lift the basket drive support off the washer base.



SERVICE NOTES:

- While the basket drive is removed, check for shaft wear, using the procedure shown on page 5-8.

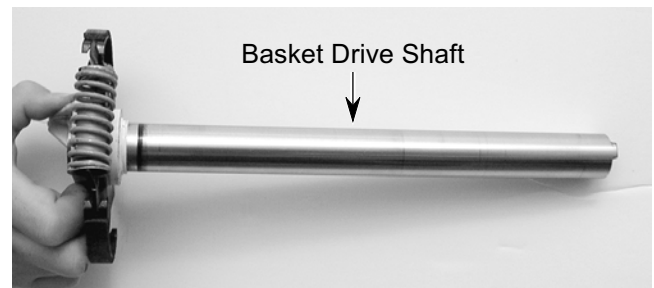

- If the brake drum on the basket drive support is removed for any reason, it will have to be properly aligned with the clutch engagement cam when it is reinstalled. If this is not done, the clutch pads and drum will wear prematurely, and the basket will contact the cabinet on spin down, causing a loud “bang.”

To align the drum with the clutch engagement cam:

- Install the brake drum on the basket drive support with its three 1/2” hex-head bolts and tighten them until they are just finger tight.
- Insert the shaft of the basket drive assembly into the basket drive support while turning the clutch engagement cam counterclockwise. Turning the clutch will compress the basket drive spring, and allow the basket drive to clear the brake drum. Push the basket drive assembly into the basket drive support until the assembly bottoms out.

- Carefully turn the clutch engagement cam counterclockwise two complete revolutions, while applying enough force to the cam to insure that the basket drive linings firmly contact the brake drum.

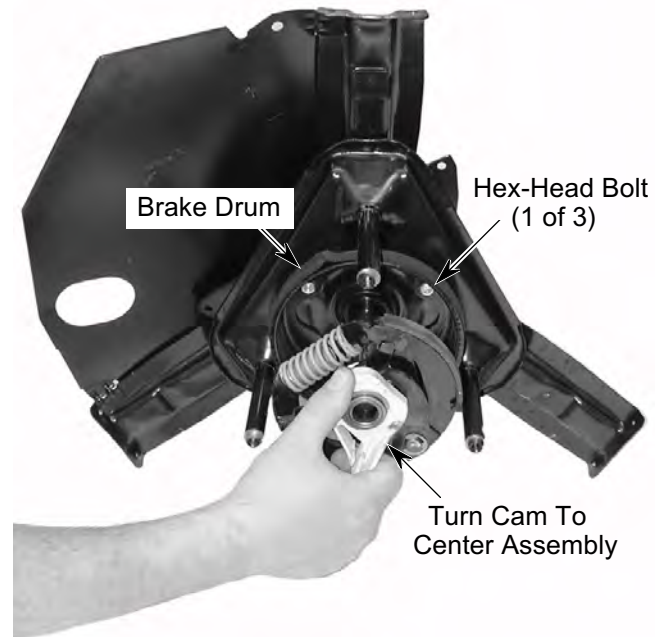

- Increase pressure on the clutch engagement cam to compress the basket drive spring, then remove the basket drive from the support. Make sure that the basket drive linings do not touch the drum during the removal process.
- Retighten each of the hex-head bolts a little at a time until all three bolts are secure.

REMOVING THE SUSPENSION SYSTEM & BASE ASSEMBLY

⚠️ WARNING



Electrical Shock Hazard

Disconnect power before servicing.

Replace all parts and panels before operating.

Failure to do so can result in death or electrical shock.

1. Unplug washer or disconnect power.
2. **To remove the skate plate and suspension pads:**
 - a) Remove the tub ring, basket, and outer tub (see steps 4 through 6 on pages 4-18 through 4-20 for the procedures).
 - b) Lift the skate plate off the base assembly.

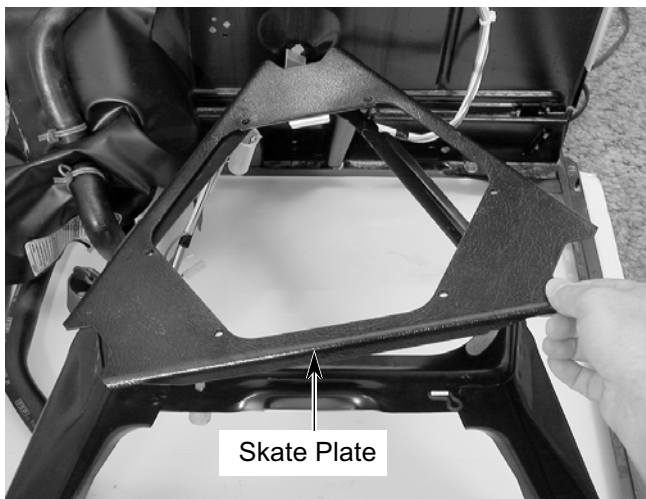

Shown With Lower Surface Facing Up

- c) Pry the three suspension pads off the top of the base assembly and replace them (see the photo at the top of the next column).

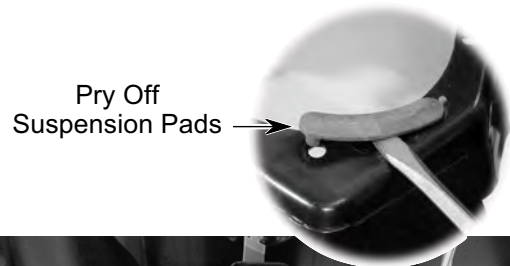

3. **To remove the base assembly:**
 - a) Remove the tub ring, basket, outer tub, and basket drive assembly (see steps 4 through 7 on pages 4-18 through 4-20 for the procedures).
 - b) Remove the skate plate (see step 2b).
 - c) Remove two 5/16" hex-head base assembly screws from the rear panel.
 - d) Remove the rear panel from the base assembly.
 - e) If you are replacing the base assembly, remove the feet, springs, etc. from the assembly. **NOTE:** The new base plate is supplied with suspension pads already installed.

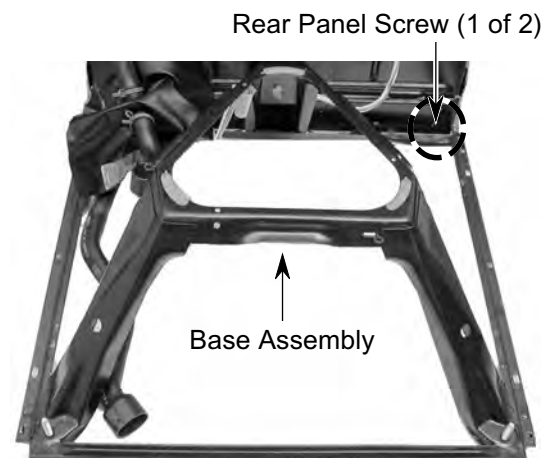

REMOVING THE REAR PANEL HIGH EFFICIENCY COMPONENTS

⚠️ WARNING



Electrical Shock Hazard
Disconnect power before servicing.
Replace all parts and panels before operating.
Failure to do so can result in death or electrical shock.

The following rear panel High Efficiency components are serviced in this section:

- Dual Water Inlet
- Thermistor
- Rinse Water Pressure Switch
- Air Dome
- Diverter Valve Assembly

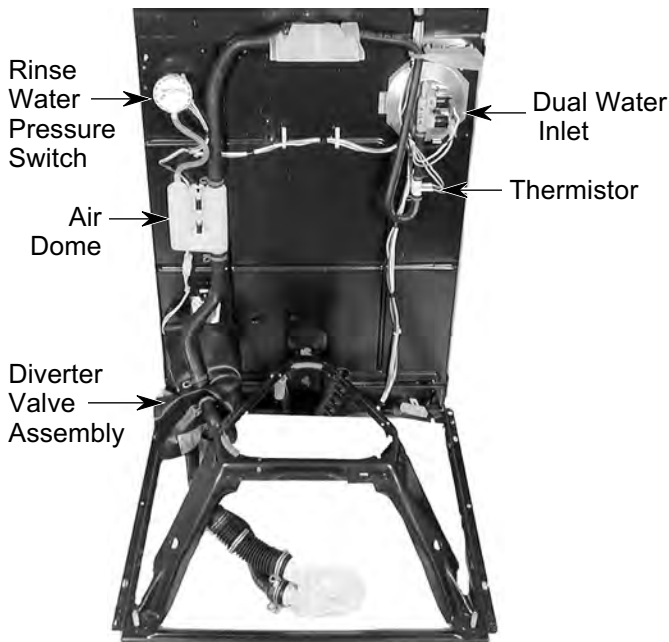

Rear Panel High Efficiency Components

1. Unplug washer or disconnect power.
2. Position the washer so that you can access the rear panel.
3. **To remove the dual water inlet:**
 - a) Remove the two 5/16" hex-head screws and the 1/4" hex-head screw from the dual water inlet mounting plate. Lift the dual water inlet to unhook it from the hole in the plate, and remove the plate from the rear panel.

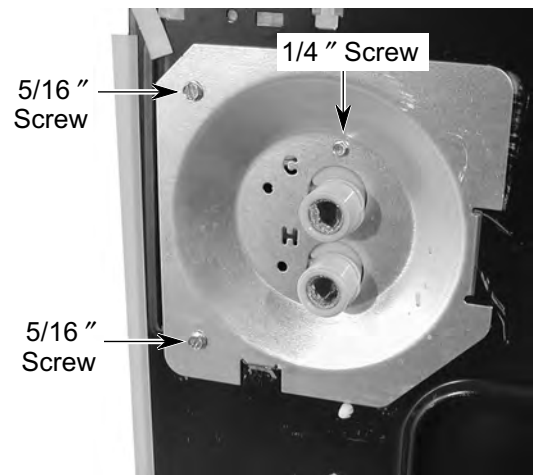

- b) Pull the dual water inlet out of the rear panel opening and disconnect the two wire connectors from the terminals. **NOTE:** Make sure to reinstall the red and white connectors as shown below.
- c) Disconnect the end of the hose and empty the water inside the hose into a container.

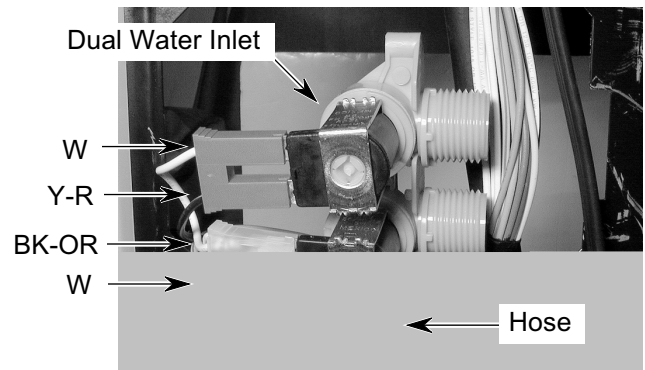

Continued on the next page.

4. To remove the thermistor:

- a) Reach inside the dual water inlet opening and grasp the thermistor, then push the two pins out of their rear panel holes, slide the thermistor mounting tab to the left, and pull it out of the slot.

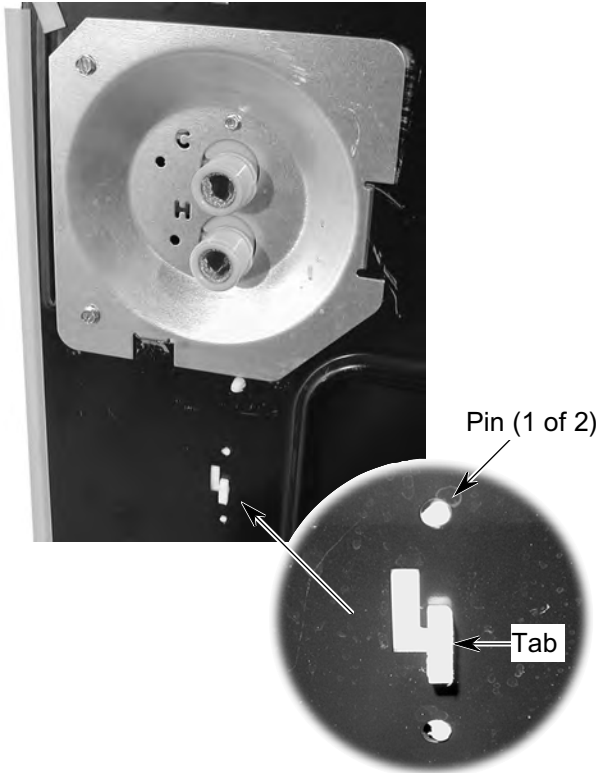

- b) Disconnect the two hoses from the thermistor.
- c) Disconnect the two wire connectors from the thermistor terminals.

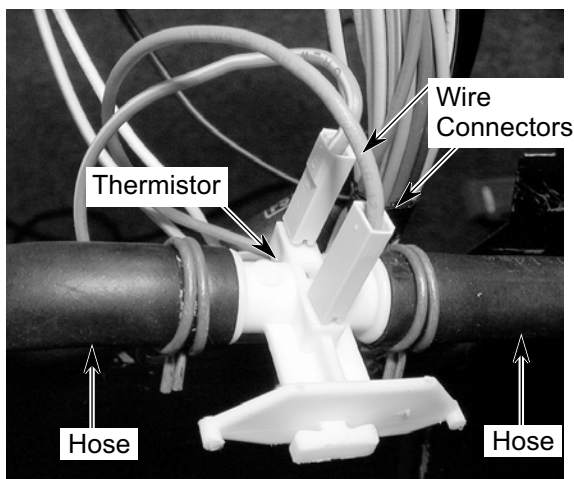

5. To remove the rinse water pressure switch and air dome:

- a) Remove the front panel from the cabinet (see page 4-10 for the procedure).
- b) Reach back and disconnect the hose and wire connector from the pressure switch.
- c) Press the locking arm on the pressure switch, then rotate the switch in either direction until the square extrusion on the switch aligns with the cutout in the rear panel, and remove the switch.

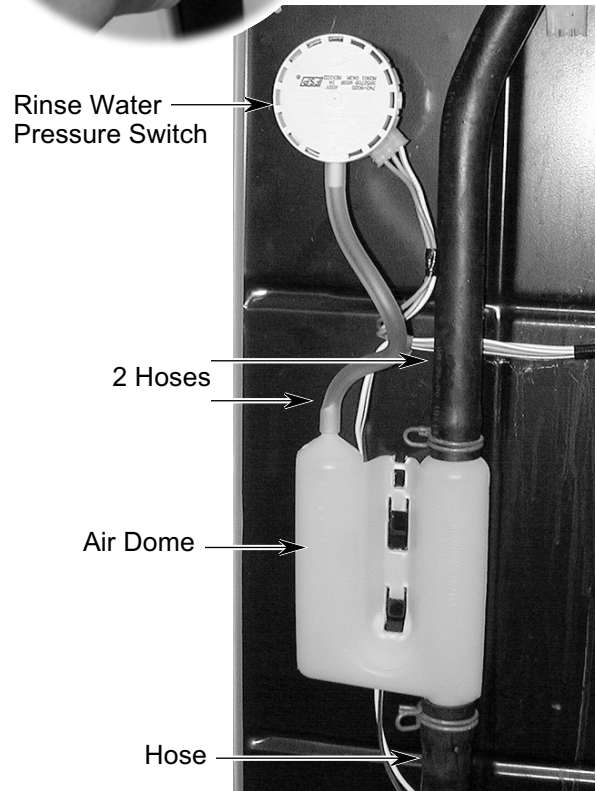
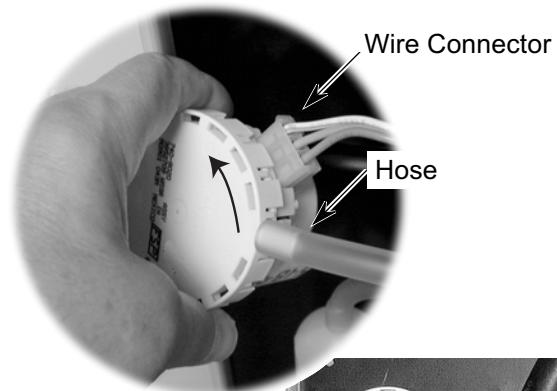

- d) Lift the air dome and unhook it from the rear panel.
- e) Disconnect the three hoses.

6. **To remove the diverter valve assembly:**

- a) On the rear panel, remove the two 3/8" hex-head diverter screws from the drain pan.
- b) Tilt the washer back at a 45° angle, or lay it on its back panel.

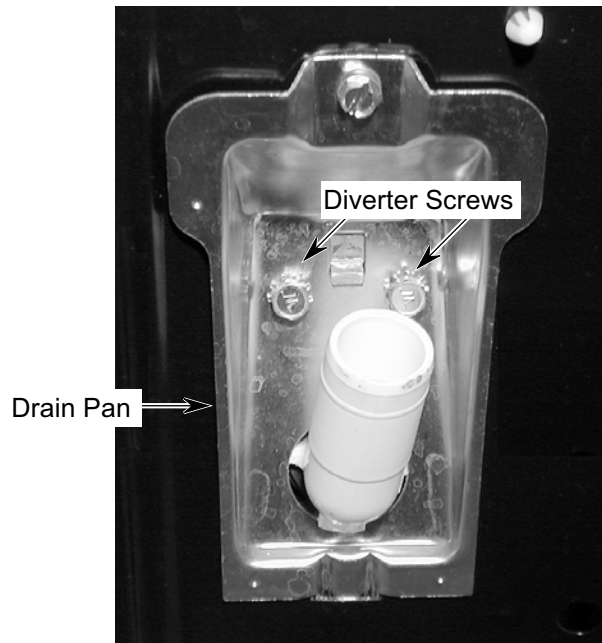

- c) Disconnect the 2-pin connector from the wiring harness.
- d) Disconnect the three hoses from the diverter valve assembly. Note the configuration of the plastic cover so you can reconnect the hoses properly.

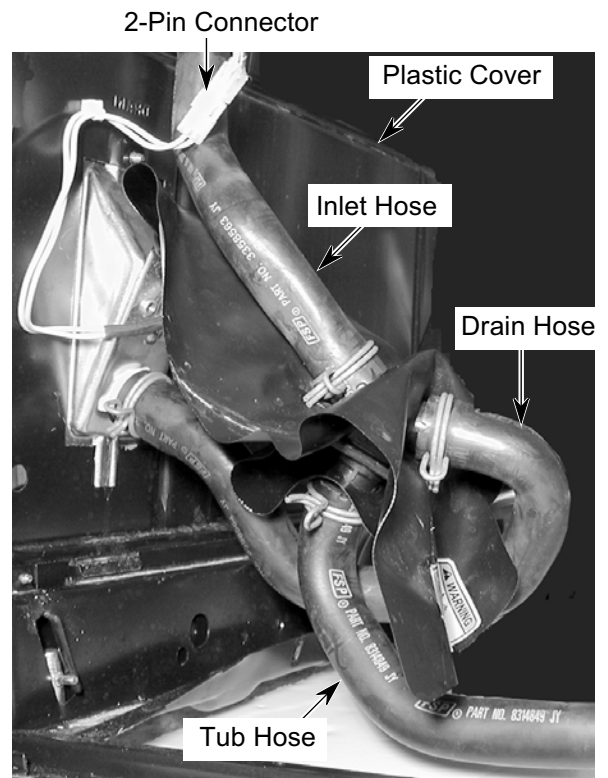

— NOTES —

COMPONENT TESTING

Before servicing, check the following:

- Plug into a grounded 3-prong outlet.
- Check for a blown household fuse or circuit breaker that has tripped.
- Check the connections before replacing a component. Look for broken or loose wires, failed terminals, or wires that are not pressed into their connectors far enough.
- Check for wire connectors that are not pressed tightly onto their terminals.
- Resistance tests must be made with the power cord unplugged from the outlet, and with the wiring disconnected.
- All tests should be made with a VOM (volt-ohmmeter) or DVM (digital voltmeter) having a sensitivity of 20,000 ohms-per-volt DC or greater.



⚠ WARNING

Electrical Shock Hazard

Disconnect power before servicing.

Replace all parts and panels before operating.

Failure to do so can result in death or electrical shock.

DIVERTER VALVE

Refer to page 4-25 for the procedure for servicing the diverter valve.

1. Unplug washer or disconnect power.
2. Set the ohmmeter to the R x 1K scale.
3. Disconnect the 2-wire connector from the wiring harness on the rear panel.
4. Touch the ohmmeter test leads to the connector pins coming from the diverter valve. The meter should indicate approximately 8k to 10k Ω .
5. Manually operate the solenoid plunger and make sure that it operates freely without binding.

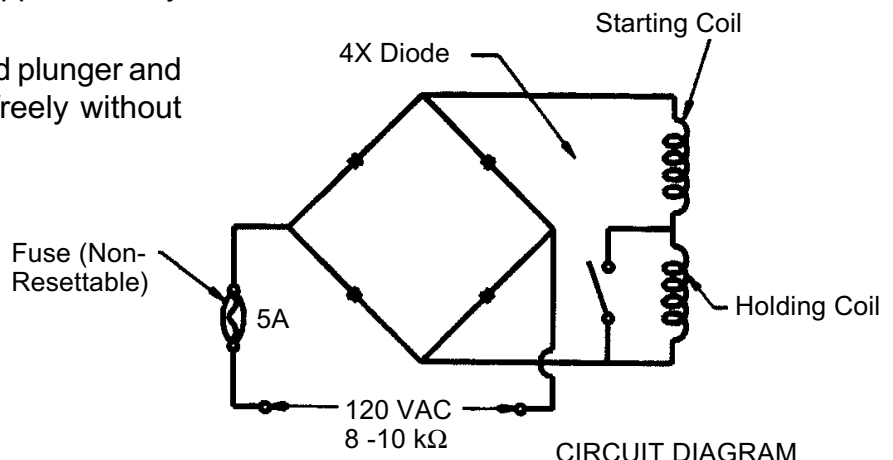
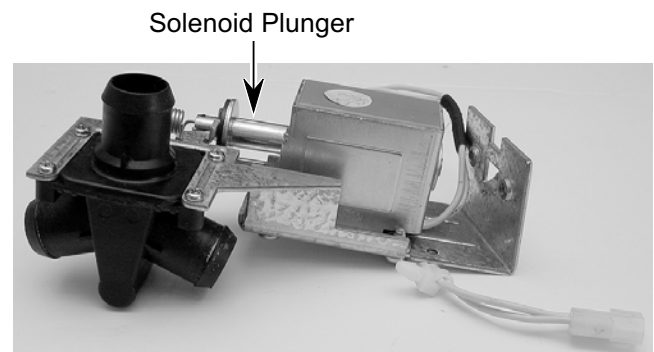



⚠️ WARNING

Electrical Shock Hazard

Disconnect power before servicing.

Replace all parts and panels before operating.

Failure to do so can result in death or electrical shock.

MOTOR

Refer to page 4-11 for the procedure for servicing the motor.

1. Unplug washer or disconnect power.
2. Set the ohmmeter to the R x 1 scale.
3. Disconnect the plug from the motor connector.
4. Touch the ohmmeter test leads to the following motor lead colors (shown on the connector plate). The meter should indicate as shown in the Motor Test Table.
5. Touch the ohmmeter test leads to the following motor switch connections. The meter should indicate as shown in the Motor Switch Test Table.

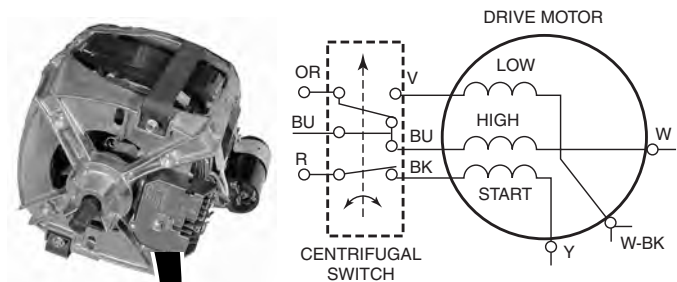

Motor Connector

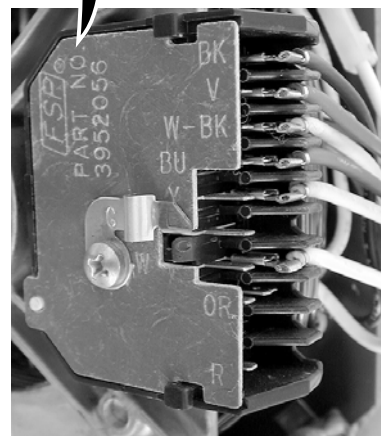

MOTOR TEST TABLE

FUNCTION	TEST TERMINALS	READING
LOW SPEED	V TO W-B	18-26 OHMS
HIGH SPEED	BU TO W	1 TO 1.5 OHMS
START WINDING	BK TO Y	5 TO 10 OHMS
THERMAL PROTECTOR	W TO W	0 OHMS

MOTOR SWITCH TEST TABLE

STATE	TEST TERMINALS	READING
AT REST	R TO BK	1 TO 2 OHMS
	OR TO BU	
	OR TO V	
AT SPEED OR SWITCH ARM RELEASED*	R TO BU	OPEN (INFINITE OHMS)
	R TO BK	
	OR TO BU	1 TO 2 OHMS
	OR TO V	
	R TO BU	

* SWITCH ARM CAN BE RELEASED BY REMOVING THE SWITCH FROM THE MOTOR



⚠️ WARNING

Electrical Shock Hazard

Disconnect power before servicing.

Replace all parts and panels before operating.

Failure to do so can result in death or electrical shock.

MOTOR THERMAL PROTECTOR

Refer to page 4-11 for the procedure for servicing the motor.

1. Unplug washer or disconnect power.
2. Set the ohmmeter to the R x 1 scale.
3. Disconnect one of the wires from the motor thermal protector.
4. Touch the ohmmeter test leads to the terminals of the motor thermal protector. The meter should indicate a closed circuit (0Ω).
5. Press the actuator button on the motor thermal protector. The meter should indicate an open circuit (infinite).

Motor Thermal Protector

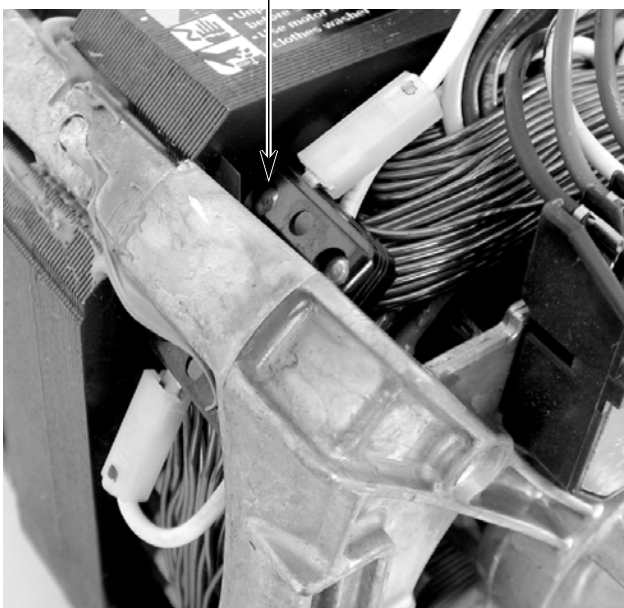

DUAL WATER INLET

Refer to page 4-23 for the procedure for servicing the dual water inlet.

1. Unplug washer or disconnect power.
2. Set the ohmmeter to the R x 1 scale.
3. Disconnect the wire connectors from the dual water inlet solenoids.
4. Touch the ohmmeter test leads to each of the solenoid terminals. The meter should indicate approximately 800 to 1300 Ω for each solenoid.

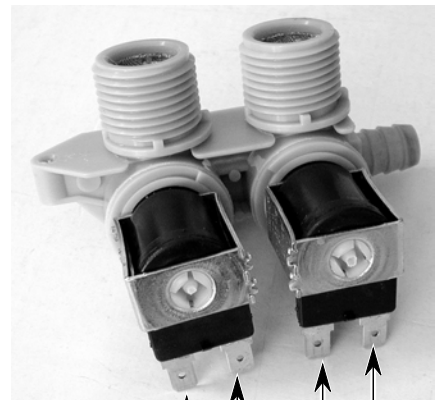

Solenoid Connectors



⚠️ WARNING

Electrical Shock Hazard

Disconnect power before servicing.

Replace all parts and panels before operating.

Failure to do so can result in death or electrical shock.

THERMISTOR

Refer to page 4-24 for the procedure for servicing the thermistor.

1. Unplug washer or disconnect power.
 2. Set the ohmmeter to the R x 10K scale.
- NOTE: The thermistor can be checked at either of two locations: the thermistor, or the ATC control board, connections 2 (OR-W) and 9 (P).
3. Disconnect the wire connectors from the thermistor or unplug ATC board.
 4. Touch the ohmmeter test leads to the thermistor terminals or ATC board connector. Depending on the temperature, the meter should indicate as shown in the Thermistor Resistance Chart.

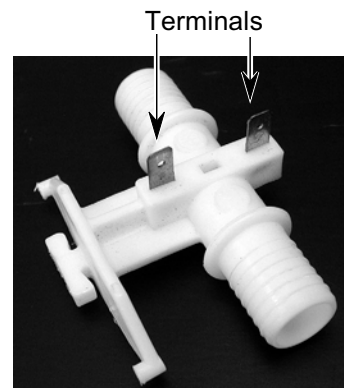

THERMISTOR RESISTANCE CHART	
Temperature (°F)	Resistance (Ohms)
40	126k - 135k
50	97k - 102k
60	75k - 78k
70	58k - 61k
80	46k - 47k
90	36k - 37k
100	28k - 30k
110	23k - 24k
120	18k - 19k
130	15k - 16k
140	12k - 13k
150	10k - 11k



⚠ WARNING

Electrical Shock Hazard

Disconnect power before servicing.

Replace all parts and panels before operating.

Failure to do so can result in death or electrical shock.

HIDDEN LID SWITCH

Refer to page 4-8 for the procedure for servicing the hidden lid switch.

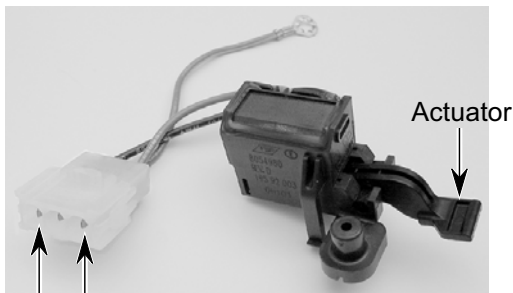

Pins 1 & 3

1. Unplug washer or disconnect power.
2. Set the ohmmeter to the R x 1 scale.
3. Disconnect the 3-wire hidden lid switch connector from the top of the washer.
4. Touch the ohmmeter test leads to hidden lid switch connector pins 1 and 3. The meter should indicate an open circuit (infinite).
5. With the ohmmeter test leads at pins 1 and 3 of the hidden lid switch connector, press the actuator on the hidden lid switch. The meter should indicate a closed circuit (0Ω).

MOTOR START CAPACITOR

Refer to page 4-11 for the procedure for servicing the motor start capacitor.



1. Unplug washer or disconnect power.
2. Set the ohmmeter to the R x 1K scale.
3. Discharge the capacitor by touching each of the terminals with a 20,000 Ω (red, black, orange) resistor to ground.
4. Disconnect the wire connectors from the capacitor terminals.
5. Touch the ohmmeter test leads to the capacitor terminals. The meter should quickly rise to a low resistance, (see the Illustration), and then gradually fall to a high resistance. To repeat the test, reverse the ohmmeter leads. The result should be the same if the capacitor is good.

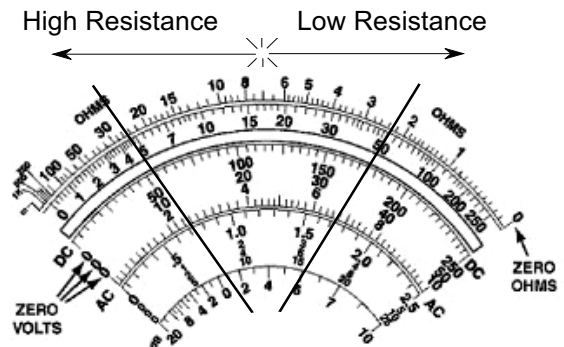



⚠️ WARNING

Electrical Shock Hazard

Disconnect power before servicing.

Replace all parts and panels before operating.

Failure to do so can result in death or electrical shock.

PRESSURE SWITCH

Refer to page 4-2 for the procedure for servicing the high and low water level pressure switches, and to page 4-24 for the procedure for servicing the rinse water pressure switch.

1. Unplug washer or disconnect power.
2. Set the ohmmeter to the R x 1 scale.
3. Disconnect the wire connector from the pressure switch.

NOTE: To activate the pressure switch, blow into the pressure hose inlet.

4. Touch the ohmmeter test leads to the test points indicated in the Water Level Switch Test Table. The switch should change states when sufficient air pressure is applied to the pressure hose inlet.

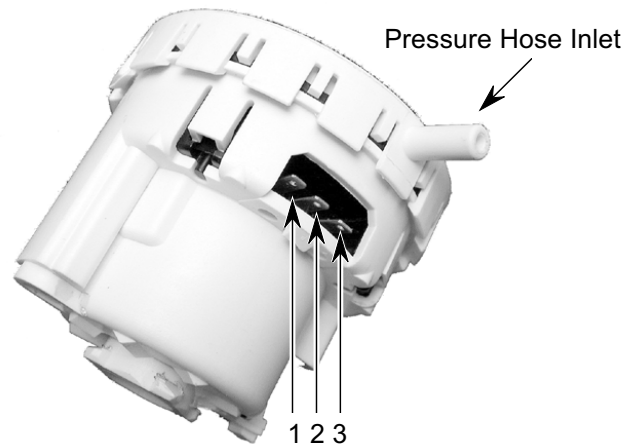

Pin 1 = Full
 Pin 2 = C (Common)
 Pin 3 = Empty

WATER LEVEL SWITCH TEST TABLE

SWITCH	LOCATION	STATE	TEST TERMINALS	WIRE COLORS	READING
RINSE WATER LEVEL SWITCH	BACK PANEL	UNDER PRESSURE	C TO EMPTY	W-P TO P	OPEN
			C TO FULL	W-P TO T	0-10 OHMS
		NO PRESSURE	C TO EMPTY	W-P TO P	0-10 OHMS
			C TO FULL	W-P TO T	OPEN
WASH HIGH LEVEL SWITCH	LEFT SIDE OF CONSOLE	UNDER PRESSURE	C TO EMPTY	V-W TO W-P	OPEN
			C TO FULL	V-W TO T	0-10 OHMS
		NO PRESSURE	C TO EMPTY	V-W TO W-P	0-10 OHMS
			C TO FULL	V-W TO T	OPEN
WASH LOW LEVEL SWITCH	RIGHT SIDE OF CONSOLE	UNDER PRESSURE	C TO EMPTY	V-Y TO W-P	OPEN
			C TO FULL	V-Y TO T	0-10 OHMS
		NO PRESSURE	C TO EMPTY	V-Y TO W-P	0-10 OHMS
			C TO FULL	V-Y TO T	OPEN



⚠️ WARNING

Electrical Shock Hazard

Disconnect power before servicing.

Replace all parts and panels before operating.

Failure to do so can result in death or electrical shock.

CYCLE SELECTOR SWITCH ASSEMBLY

Refer to page 4-3 for the procedure for servicing the cycle selector switch assembly.

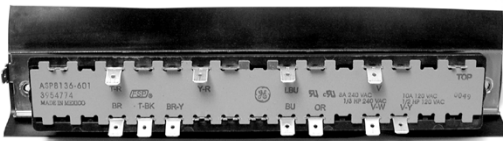

1. Unplug washer or disconnect power.
2. Set the ohmmeter to the R x 1 scale.
3. Disconnect the wires from the terminals of the switch to be measured.
4. Touch the ohmmeter test leads to the following terminals (the wire colors are shown stamped on the switch plate). Press the indicated pushbutton to activate the switch. Test the switch in both the On and Off positions. On = Closed (0Ω) - Off = Open (infinite) as indicated in the Cycle Selector Switch Test Table below.

TIMER MOTOR

Refer to page 4-6 for the procedure for servicing the timer.

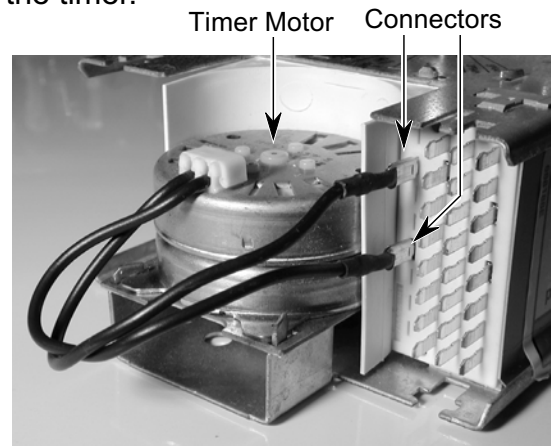

1. Unplug washer or disconnect power.
2. Set the ohmmeter to the R x 1 scale.
3. Disconnect both of the 9-pin wire connectors from the harness.
4. Disconnect one of the timer motor wire terminals from the motor connector pin.
5. Touch the ohmmeter test leads to the timer motor wire connectors. The meter should indicate between 2000 and 2800 Ω .

CYCLE SELECTOR SWITCH TEST TABLE

FUNCTION	SWITCH POSITION	WIRE COLORS	READING
WATER LEVEL	HIGH	V TO V-W	CLOSED SWITCH 0 OHMS ACROSS SWITCH TERMINALS (DISCONNECT WIRES FROM SWITCH TO INSURE PROPER READING)
	LOW	V TO V-Y	
SPIN SPEED	HIGH	LBU TO BU	
	LOW	LBU TO OR	
TEMPERATURE/ CYCLE SELECTIONS	COLD COLD	BR TO Y-R	
	WARM* COLD	BR-Y TO Y-R, BR-Y TO TR	
	WARM* WARM*	BR TO Y-R, T-R TO T-BK TO BR-Y	
	HOT* COLD	BR TO T-R, BR-Y TO Y-R	

*ATC CONTROLLED CYCLES
HOT CONTROLLED TO 100+-5, WARM CONTROLLED TO 70+-5



⚠️ WARNING

Electrical Shock Hazard

Disconnect power before servicing.

Replace all parts and panels before operating.

Failure to do so can result in death or electrical shock.

BASKET DRIVE SHAFT CHECKS

Refer to page 4-20 for the procedure for servicing the basket drive.

1. With the basket drive removed, check for excessive wear on the shaft (see below). Excessive wear can be identified by a ridge between the bearing contact surfaces, and the center area of the shaft. If ridges can be felt along the bearing wear areas (greater than .005"), replace the basket drive.
2. If replacement of the upper and lower centerpost seals is ever necessary, check for wear ridges on the basket drive shaft. If ridges are present, replace the basket drive.

BASKET DRIVE SHAFT →

Upper Centerpost Seal Wear Area →

Upper Bearing Wear Area →

Center Area Between Bearing Contact Surfaces →

Lower Bearing Wear Area →

Lower Centerpost Seal Wear Area →

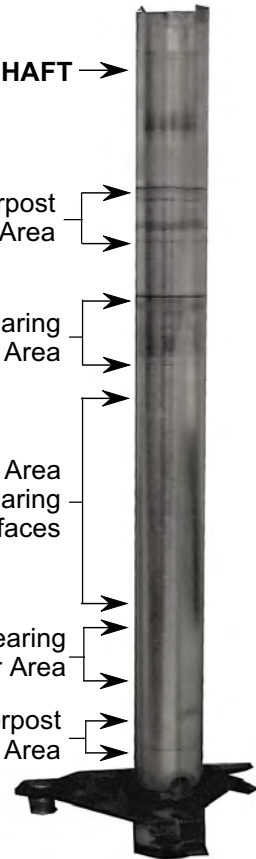



⚠️ WARNING

Electrical Shock Hazard

Disconnect power before servicing.
Replace all parts and panels before operating.
Failure to do so can result in death or electrical shock.

AUTOMATIC TEMPERATURE CONTROL

Perform the following tests in sequence.

Test 1: Non-ATC Wash Fills

NOTE: The non-ATC system must function properly before testing the ATC system.

1. Set the timer to the Fill cycle, and start the washer. The washer will begin filling.
2. Turn the water temperature switch to each of the non-ATC positions, and note the temperature of the water entering the washer at each position (COLD/COLD).

If the temperatures are not correct, or the washer is not filling, check the following for the proper operation and function:

<u>Component</u>	<u>Problem Check</u>
Timer	No fill
Water Level Switch	No fill or wrong water level
Water Temp Switch	No fill or wrong water temp
Water Valves	No fill or slow fill

Test 2: ATC Wash Fills

This tests the ATC portion of the ATC control.

1. Set the water temp switch to ATC controlled WARM/COLD.
2. The washer will begin filling.

Both the hot and cold valves operate continuously for approximately 55 seconds. After 55 seconds, the cold valve should cycle on and off, while the hot valve stays on continuously.

If the cold valve is not working properly:

1. Unplug washer or disconnect power.
2. Check the ATC board for proper installation at the connector.
3. Make sure that the harness wires are in the proper location to the connector, as shown below.

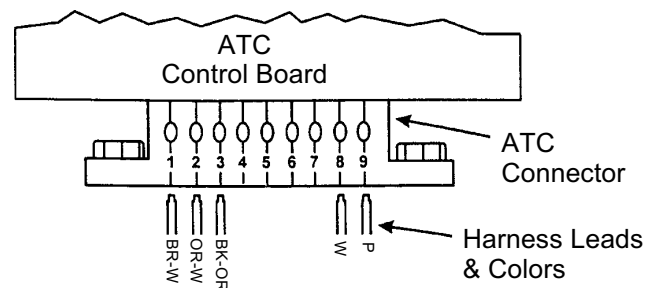

Continued on the next page.

4. Remove the ATC control board from the connector.
5. Using an ohmmeter set to the R x 10K scale, measure the thermistor resistance across the ATC connector points 2 (OR-W) and 9 (P). Compare the readings to the Thermistor Resistance Chart.

THERMISTOR RESISTANCE CHART	
Temperature (°F)	Resistance (Ohms)
40	126k - 135k
50	97k - 102k
60	75k - 78k
70	58k - 61k
80	46k - 47k
90	36k - 37k
100	28k - 30k
110	23k - 24k
120	18k - 19k
130	15k - 16k
140	12k - 13k
150	10k - 11k

- NOTE 1:** If the hot water temperature is below 120°F, the cold valve may turn off and stay off.
- NOTE 2:** If the cold water temperature is above 70°F, the cold valve may stay on continuously.
- NOTE 3:** If the thermistor is open, the cold valve will stay off. If the thermistor is shorted, the cold valve will stay on continuously.
- NOTE 4:** When the COLD/COLD cycle is selected, the ATC feature is bypassed. This will provide uncontrolled cold wash and cold rinse.

If ohmmeter reading is not correct:

1. Replace the thermistor, (see page 4-24 for the procedure), and repeat steps 1 and 2 of "ATC Wash Fills."
2. Set the water temp switch to ATC controlled WARM/WARM.
3. Start the washer. The washer will begin filling. The hot valve should cycle on and off while the cold valve operates continuously.

NOTE: If the cold water temperature is above 65°F, the hot valve may not turn on.

If the hot valve is not working properly:

1. Unplug washer or disconnect power.
2. Replace the ATC board, (see page 4-3 for the procedure), and repeat steps 2 and 3 above.

Repeat the ATC Wash Fills Test for all three (3) ATC controlled water temp switch positions.

NOTE: For additional information on the Automatic Temperature Control System, refer to Job Aid #4322334.

AGITATION CYCLE SWITCH CLOSURES

AGITATION/CYCLE SWITCH CLOSURES								
SW.	WTR LVL		SPEED		TEMPERATURE			
	LO	HI	LO	HI	COLD	75°	75°	100°
					COLD	COLD	75°	COLD
A								X
B							X	
C						X	X	
D								X
E					X	X	X	
F				X				
G			X					
H		X						
I	X							
100° F ±5°								
75° F ±5°								

SEQUENCE CHART

NOTE	ENTER STEP	TIMER CAM & SWITCH SEQUENCE		
		FIRST	SECOND	THIRD
A	1	3T, 8T, 12B, 5B OFF IN THE OFF NOTCH, SWITCHES ON CAMS 8T, 12B, 10B, 14T, 5B ARE OPEN	14T OFF THEN 14T ON	1T & 10B ON SEE NOTES 9 & 10
B	22	14B OFF	CAM 4, CAM 12	6B ON
C	26	6B OFF	6T ON DURING ADVANCE	8B ON, 6T OFF
D	27, 28, 29	6T ON DURING ADVANCE		6T OFF
E	31	6B ON, 12B OFF	8T ON, CAM 10	12T BEFORE 10B OFF
F	39	1B ON	CAM 10	12T BEFORE 10B OFF
G	35, 43, 47	12B-12T LIFT AS SHORT AS POSSIBLE	2 MAY BE ON AT END OF ADVANCE	12T BEFORE 10B OFF
H	32, 36, 40, 44	10T BEFORE 12T TO 12B. EARLY AS POSSIBLE		
I	51	14T BEFORE 12T TO 12B, 12T-14T OVERLAP IS EARLY AND AS SHORT AS POSSIBLE. 5B - NO SEQUENCE		
J	60	THIS AN ACTIVE 30 SECOND STEP. OFF IS A NOTCH BETWEEN 60 & 1 AND IS SMALL AS POSSIBLE.		

BUSSING DIAGRAM

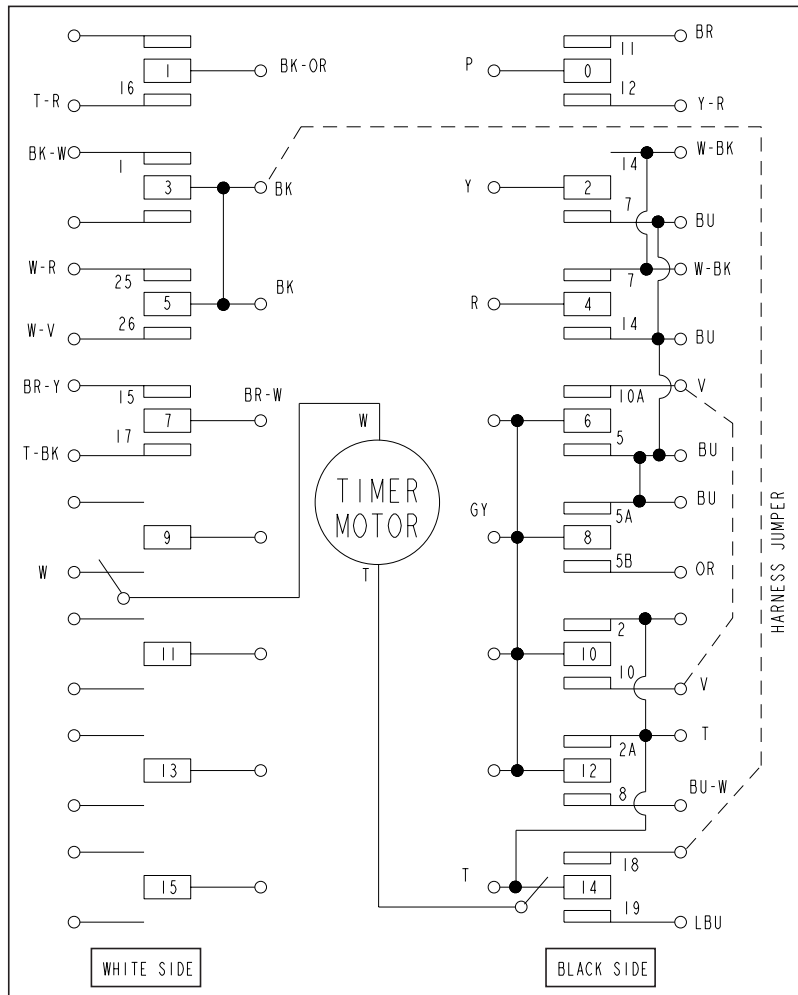

TIMER LABEL (Opposite Side From Knob)

WHITE			BLACK		
T	C	B	B	C	T
○	BK-OR	* T-R	* Y-R	P	* BR
* BK-W	BK	○	* BU	Y	* W-BK
* W-R	BK	* W-V	* BU	R	* W-BK
* BR-Y	BR-W	* T-BK	□ BU	GY	* V
○		○ W	□ OR	GY	□ BU
○		○	+ V	GY	* T
○		○	+ BU-W	GY	* T
○		○	□ LBU	T	* BK

CONNECTORS

ATC CONNECTOR

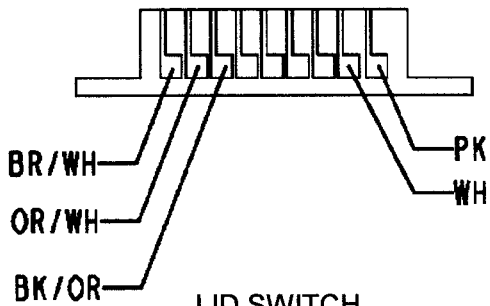

LID SWITCH

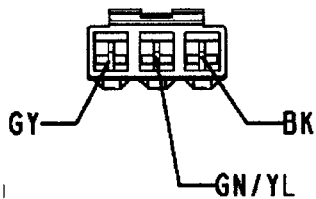

WATER LEVEL SWITCH CONNECTOR
(BOTH HIGH AND LOW)

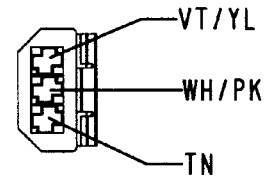

MOTOR CONNECTOR

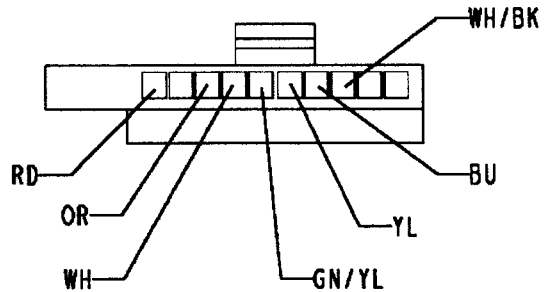

TIMER HARNESS CONNECTORS (HARNESS SIDE)

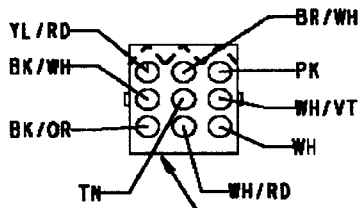

FEMALE MOLEX

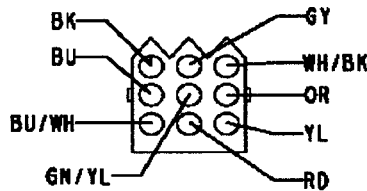

MALE MOLEX

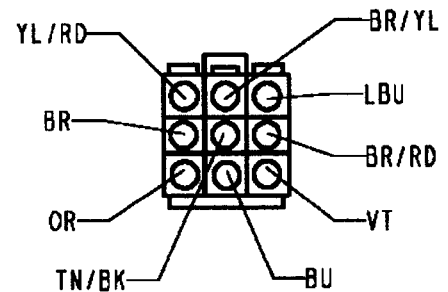

FEMALE MOLEX

TIMER CONNECTORS

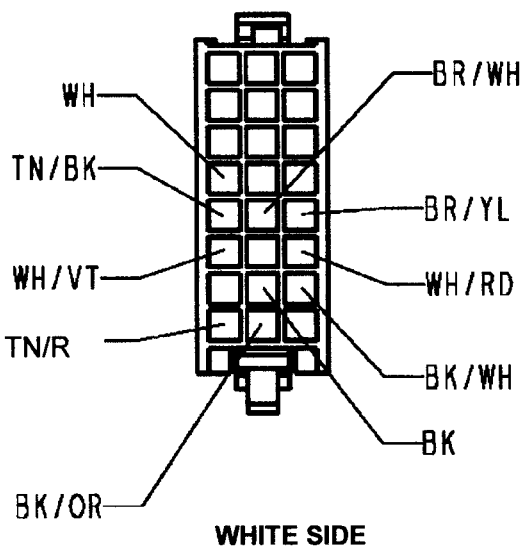

WHITE SIDE

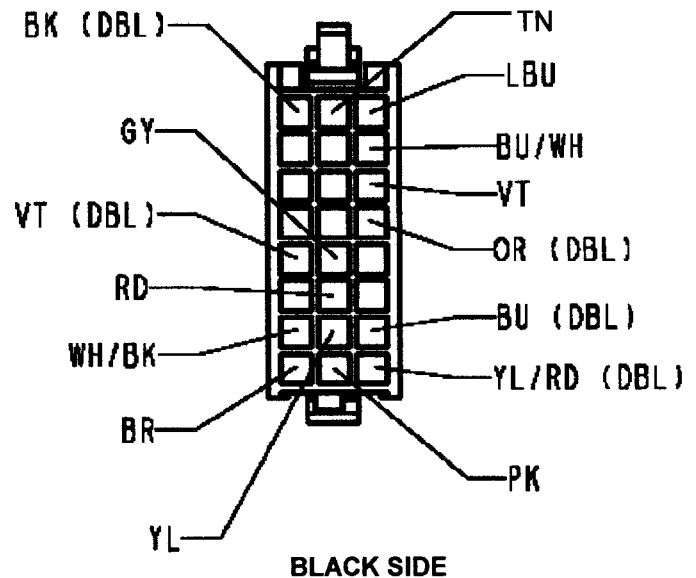

BLACK SIDE

WIRING DIAGRAM

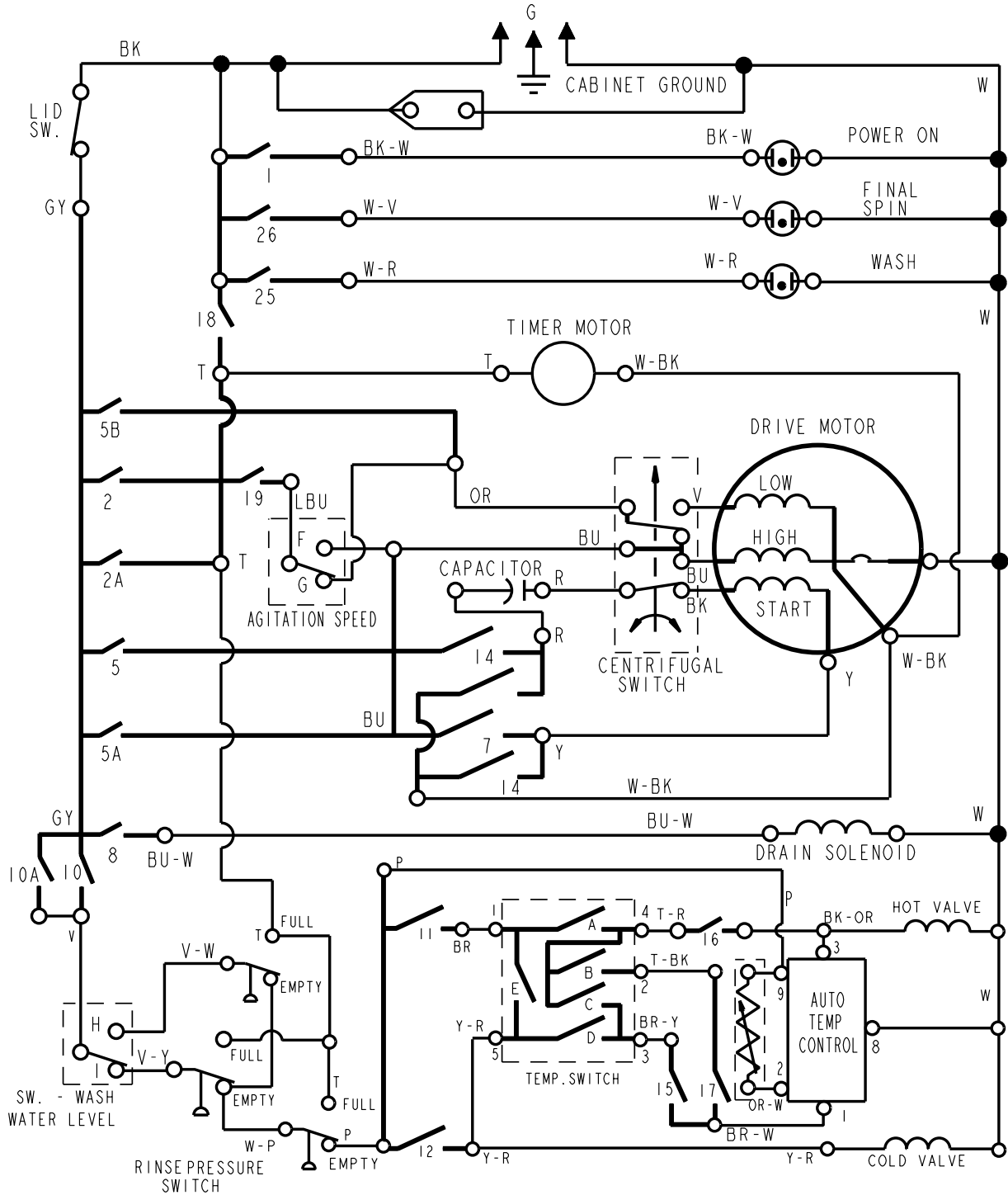

LEGEND

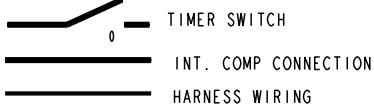

○ TERMINAL CONNECTION

● HARNESS CONNECTION

X TIMER SWITCH MAY BE OPEN OR CLOSED

— NOTES —

— U.S.A. —
**ONE STOP NUMBER FOR COMMERCIAL
LAUNDRY SUPPORT 1 800-NO BELTS**

(1 800 662-3587)

Commercial Laundry Internet Support
www.whirlpoolwebworld.com
Products and More, Commercial Laundry Link

***Or go directly to www.whirlpoolcorp.com/cltpsc
1 800-NO BELTS OPTION 1***

**FOR SALES LITERATURE ORDERS, PRODUCT AND WARRANTY INFORMATION,
ROUTE OPERATOR AND DISTRIBUTOR LOCATION:
1 800-NO BELTS OPTION 2**

**TO ORDER COMMERCIAL LAUNDRY PRODUCT:
1 800-NO BELTS OPTION 3**

**FOR WARRANTY CLAIMS STATUS, LABOR AUTHORIZATIONS OR MISSING PARTS:
1 800-NO BELTS OPTION 4**

**FOR TECHNICAL ASSISTANCE FOR ALL WHIRLPOOL
COMMERCIAL LAUNDRY PRODUCTS:
1 800-NO BELTS OPTION 5**

**FOR PARTS ORDERS:
1 800-NO BELTS OPTION 6**

