



CONSUMER SERVICES TECHNICAL  
EDUCATION GROUP PRESENTS

KM-29

# SPEEDCOOK MICROWAVE OVEN WITH CONVECTION



MODELS: GH6208XR, GH7208XR

JOB AID  
Part No. 8178545



## FORWARD

This Whirlpool Job Aid, “Speedcook Microwave Oven With Convection” (Part No. 8178545), provides the technician with information on the installation, operation, and service of the Speedcook Microwave Oven With Convection. For specific information on the model being serviced, refer to the “Use and Care Guide,” or “Tech Sheet” provided with the Speedcook Microwave Oven With Convection.

The Wiring Diagram and Strip Circuits used in this Job Aid are typical and should be used for training purposes only. Always use the Wiring Diagram supplied with the product when servicing the unit.

## GOALS AND OBJECTIVES

The goal of this Job Aid is to provide information that will enable the service technician to properly diagnose malfunctions and repair the Speedcook Microwave Oven With Convection.

The objectives of this Job Aid are to:

- Understand and follow proper safety precautions.
- Successfully troubleshoot and diagnose malfunctions.
- Successfully perform necessary repairs.
- Successfully return the microwave oven to its proper operational status.

WHIRLPOOL CORPORATION assumes no responsibility for any repairs made on our products by anyone other than Authorized Service Technicians.

# TABLE OF CONTENTS

Page

<b>GENERAL</b> .....	1-1
Microwave Oven Safety .....	1-1
Warning To Service Technicians .....	1-2
Precautions To Be Observed Before And During Servicing To Avoid Possible Exposure To Excessive Microwave Energy .....	1-3
RF Leakage Test .....	1-4
Precautions To Be Observed While Troubleshooting .....	1-5
Whirlpool Model & Serial Number Designations .....	1-6
Model & Serial Number Label And Tech Sheet Locations .....	1-7
Specifications .....	1-8
<b>INSTALLATION INFORMATION</b> .....	2-1
Installation Requirements .....	2-1
Installation Instructions .....	2-3
<b>PRODUCT OPERATION</b> .....	3-1
Parts And Features .....	3-1
Oven Control .....	3-4
Using The Quick Reference Guide .....	3-11
<b>COMPONENT ACCESS</b> .....	4-1
Component Locations .....	4-1
Removing The Bottom Cover .....	4-2
Removing A Hood Lamp Socket, Base Thermostat, & Exhaust Fan Motor .....	4-3
Removing The Turntable Motor & The Air Tube & Vent Base .....	4-5
Removing The Relay Control Board And Line Fuse .....	4-7
Removing The Oven Door Components .....	4-10
Removing The Cavity Lamp And The Hood/Light Switch Board .....	4-14
Removing The Primary, Secondary, And Monitor Interlock Switches .....	4-16
Removing The Oven From The Installation .....	4-17
Removing The Cabinet .....	4-18
Removing The FC (Forced Convection) Thermostat, The FC Motor, And The FC Ring Heater .....	4-19
Removing The FC Thermistor, And The Cavity Thermostat & Humidity Sensor .....	4-22
Removing The Grill Thermostat And Grill Elements .....	4-24
Removing The Power Supply Cord And AC Line Filter .....	4-26
Removing The FC (Forced Convection) Thermoactuator, The Magnetron Thermistor, And The Magnetron .....	4-27
Removing The Waveguide Thermostat & Exhaust Fan Motor Capacitor .....	4-29
Removing The Cooling Fan Motor .....	4-30
Removing The Inverter Board .....	4-31
Removing The Relay Board .....	4-33

	Page
<b>COMPONENT TESTING</b> .....	5-1
Base Thermostat .....	5-1
Exhaust Fan Motor .....	5-1
Turntable Motor .....	5-2
Line Fuse .....	5-2
Door Interlock Switches .....	5-3
FC Thermostat .....	5-3
FC Motor .....	5-4
FC Ring Heater .....	5-4
FC Thermistor .....	5-5
Cavity Thermostat & Humidity Sensor .....	5-5
Grill Thermostat .....	5-6
Grill Elements .....	5-6
FC Thermoactuator .....	5-7
Magnetron Thermistor .....	5-7
Magnetron .....	5-8
Waveguide Thermostat .....	5-8
Exhaust Fan Motor Capacitor .....	5-9
Cooling Fan Motor .....	5-9
<b>DIAGNOSTICS &amp; TROUBLESHOOTING</b> .....	6-1
Primary, Secondary, And Monitor Interlock Switch Checkout Procedure .....	6-1
Troubleshooting Circuit Test Chart .....	6-2
Touch Panel And Relay Control Board Tests .....	6-2
Microwave Oven Power Output Test .....	6-3
Checking The Inverter .....	6-5
<b>WIRING DIAGRAM &amp; STRIP CIRCUITS</b> .....	7-1
Schematic Diagram .....	7-1
Strip Circuits .....	7-2
<b>TECH TIPS</b> .....	8-1
Grill Cooking Options .....	8-1
High Voltage Inverter Power Supply Test .....	8-4

# GENERAL MICROWAVE OVEN SAFETY

## **Your safety and the safety of others is very important.**

We have provided many important safety messages in this Job Aid and on the appliance. Always read and obey all safety messages.



This is the safety alert symbol.

This symbol alerts you to potential hazards that can kill or hurt you and others.

All safety messages will follow the safety alert symbol and either the word “DANGER” or “WARNING.” These words mean:

**! DANGER**

**You can be killed or seriously injured if you don't immediately follow instructions.**

**! WARNING**

**You can be killed or seriously injured if you don't follow instructions.**

All safety messages will tell you what the potential hazard is, tell you how to reduce the chance of injury, and tell you what can happen if the instructions are not followed.

## WARNING TO SERVICE TECHNICIANS

To avoid possible exposure to microwave radiation or energy, visually check the oven for damage to the door and door seal before operating any oven. Use a microwave survey meter to check the amount of leakage before servicing. In the event the R.F. leakage exceeds 4 mw/cm<sup>2</sup> at 5 cm, appropriate repair must be made before continuing to service the unit. Check interlock function by operating the door latch. The oven cook cycle should cut off before the door can be opened.

The door and latching assembly contains the radio frequency energy within the oven. The door is protected by three safety interlock switches. Do not attempt to defeat them.

**Under no circumstances should you try to operate the oven with the door open.**

- Proper operation of microwave ovens requires that the magnetron be properly assembled to the waveguide and cavity. Never operate the magnetron unless it is properly installed.
- Be sure the "RF" seal is not damaged and is assembled around the magnetron dome properly when installing the magnetron.
- Routine service safety procedures should be exercised at all times.
- Untrained personnel should not attempt service without a thorough review of test procedures and safety information contained in this Job Aid.

Whirlpool microwave ovens have a monitoring system designed to assure proper operation of the safety interlock systems.

The monitor switch will immediately cause the oven fuse to blow if the door is opened and the primary door interlock switch and/or the secondary interlock switch contacts fail in a closed position.

**CAUTION: Replace a blown fuse with a 20 ampere class H fuse only.**

Test the upper and lower door interlock switches, cook relay, and monitor switch (middle switch) for proper operation as described in the component test procedures, before replacing the blown oven fuse.

**Do not attempt to repair sticking contacts of any interlock switch, safety switch, or Cook (Latch) relay. The components must be replaced.**

Any indication of sticking contacts during component tests requires replacement of that component to assure reliability of the safety interlock system.

**If the fuse is blown, the Monitor switch, and the Primary, and Secondary interlock switches must be replaced. Be sure they are properly connected.**

# PRECAUTIONS TO BE OBSERVED BEFORE AND DURING SERVICING TO AVOID POSSIBLE EXPOSURE TO EXCESSIVE MICROWAVE ENERGY

- A. Do not operate or allow the oven to be operated with the door open.
- B. Make the following safety checks on all ovens to be serviced before activating the magnetron or other microwave source, and make repairs as necessary:
  - Interlock Operation
  - Proper Door Closing
  - Seal and Sealing Surfaces (Arcing, Wear, and Other Damage)
  - Damage to or Loosening of Hinges and Latches
  - Evidence of Dropping or Abuse
- C. Before turning on the microwave power for any service test or inspection within the microwave generating components, check the magnetron, waveguide or transmission line, and cavity for proper alignment, integrity, and connections.
- D. Any defective or misadjusted components in the interlock, monitor, door seal, and microwave generation and transmission systems shall be repaired, replaced, or adjusted, using procedures described in this Job Aid, before the oven is released to the owner.
- E. A microwave leakage check to verify compliance with Federal Performance Standard should be performed on each oven prior to release to the owner.
- F. Do not attempt to operate the oven if the door glass is broken.

# RF LEAKAGE TEST

## EQUIPMENT

Electromagnetic energy leakage monitor (NARDA 8100B, HOLADAY H 1501 ).

275 ±15 ML glass beaker.

## TEST

On every service call, checks for microwave energy emission must be made according to the following manner.

1. Remove the cooking rack from the oven cavity, if the microwave oven is so equipped.
2. Place a 275±15 ML (9.3 oz.) glass of water in the center of the oven bottom.
3. Select "HIGH" cook power, turn the microwave oven on, and test for R.F. leakage at the following locations:
  - Around the cabinet at the front.
  - Around the door.
  - Across the console panel.
  - Horizontally across the door.
  - Vertically across the door.
  - Diagonally across the door.
  - Across the air vents.
  - Across the rear air vent.
  - All lockseams.
  - Weld at bottom.
  - Bottom plate.
  - Oven feet.
4. The scan speed is one inch per second.

When checking for R.F. leakage, use an approved R.F. measuring device to assure less than 4 mw/cm<sup>2</sup> emission at 5 cm distance with a maximum scan rate of 2.54 cm/second, in compliance with U.S. Government Department of Health, Education and Welfare 21CFR1030, Performance Standard for Microwave Ovens.

A properly operating door and seal assembly will normally register small emissions, but they must be no greater than 4 mw/cm<sup>2</sup> to allow for measurement uncertainty.

**NOTE:** Enter leakage readings in space BEFORE and AFTER on the service document.

All microwave ovens exceeding the emission level of 4 mw/cm<sup>2</sup> must be reported to Dept. of Service for Microwave Ovens immediately and the owner should be told not to use the microwave oven until it has been repaired completely.

If a microwave oven is found to operate with the door open, report to Dept. of Service, the manufacturer and CDRH\* immediately. Also tell the owner not to use the oven.

The monitor switch acts as the final safety switch protecting the customer from microwave radiation. If the monitor switch operated to blow the fuse when the interlocks failed, you must replace all interlock switches with new ones, because the contacts of those interlock switches may be melted and welded together.

If safety interlock/monitor switch replacement, or adjustment, is required, you must reconnect the circuit, and perform a continuity check on the monitor circuit.

All repairs must be performed in such a manner that microwave energy emissions are minimal.

Address for CDRH is:

**Office of Compliance (HFZ-312) Center for  
Devices and Radiological Health  
1390 Piccard Drive  
Rockville, MD 20850**

\* CDRH: Center for Devices and Radiological Health, Food and Drug Administration.



# PRECAUTIONS TO BE OBSERVED WHILE TROUBLESHOOTING

The microwave oven is a high voltage, high current appliance. It is free from danger during ordinary use, but extreme care should be taken during repair.

## CAUTION

Service technicians should remove their watches whenever working close to or replacing the magnetron.

## DANGER

### HIGH VOLTAGE AND HIGH TEMPERATURE (HOT/LIVE) OF THE INVERTER POWER SUPPLY

The high voltage inverter power supply circuit supplies very high voltage and very high current for the magnetron tube. Though it is free from danger in ordinary use, extreme care should be taken during repair. The current is extremely large, and so danger exists because of its high current and high voltages.

The aluminum heat sink is also energized with high voltage (HOT), so do not touch it when the AC input terminal is connected to the power line. One of the IGBT switching power devices (collector) is directly connected to the aluminum heat sink.

The aluminum heat sink may be HOT from heat energy; therefore, extreme care should be taken during servicing and replacing.

## WARNING

### INVERTER POWER SUPPLY GROUNDING

Check the high voltage inverter power supply circuit grounding. This high voltage inverter power supply circuit board must have a proper chassis ground by the grounding bracket to the chassis ground; otherwise, this H.V. inverter circuit board will expose very high voltage, and cause extreme DANGER. Be sure to have proper grounding by the grounding plate and screws.

## WARNING

### DISCHARGING HIGH VOLTAGE CAPACITORS

For about 30 seconds after the oven is turned off, an electric charge remains in the high voltage capacitors in the inverter power supply circuit board.

When replacing or checking parts, remove the power plug from the outlet. Use a screwdriver with an insulated handle, and short the inverter output of the magnetron filament terminals to discharge it. Be sure to touch the chassis ground side first, and then touch the output terminals.

## WARNING

There is high voltage present, with high current capabilities in the circuits of the primary and secondary windings, the choke coil, and the heat sink of the inverter. It is extremely dangerous to work on or near these circuits with the microwave oven energized. DO NOT measure the voltage in the high voltage circuit, including the filament voltage of the magnetron.

## WARNING

Never touch any circuit wiring with your hand, or with an insulated tool during operation.

## WARNING

Never insert a wire, nail, or any other metal object through the lamp holes on the cavity, or any other holes or gaps. Doing so may act as an antenna, and cause microwave leakage.

## WARNING

Before touching any oven components or wiring, always unplug the oven from its power source, and discharge the capacitors in the high voltage inverter.

# WHIRLPOOL MODEL & SERIAL NUMBER DESIGNATIONS

## MODEL NUMBER

<b>MODEL NUMBER</b>	G	H	7	20	8	X	R	T	0
<b>PRODUCT GROUP</b> G = WHIRLPOOL GOLD M = MICROWAVE									
<b>PRODUCT IDENTIFICATION</b> B = BROWNER C = CONVECTION G = GRILL / CRISPER H = OTR HOOD COMBO K = KITS M = GOLD CONVECTION S = STIRRER FAN T = TURNTABLE									
<b>MODEL VARIATIONS</b> 0 - 9									
<b>CUBIC FEET</b> 20 = 2.0 CU. FT. 22 = 2.2 CU. FT.									
<b>FEATURE LEVEL</b> 8 = 28" KIT (IF KIT)									
<b>FEATURE CODE</b> C = CSA APPROVED S = CARRY IN WARRANTY (EFFECTIVE 02/96) X = IN HOME WARRANTY (EFFECTIVE 02/96)									
<b>YEAR OF INTRODUCTION</b> R = 2005									
<b>COLOR CODE</b> B = BLACK, Q = WHITE ON WHITE, T = BISCUIT, Y = GREY, S = STAINLESS STEEL									
<b>ENGINEERING CHANGE (0, 1, 2, ETC.)</b>									

## SERIAL NUMBER

<b>SERIAL NUMBER</b>	TR	S	24	10018
<b>MANUFACTURING SITE</b> TR = OXFORD, MS; SHUNDE, CHINA				
<b>YEAR OF PRODUCTION</b> S = 2005				
<b>WEEK OF PRODUCTION</b> 24TH WEEK				
<b>PRODUCT SEQUENCE NUMBER</b>				

# MODEL & SERIAL NUMBER LABEL AND TECH SHEET LOCATIONS

The Model/Serial Number label and Tech Sheet locations are shown below.

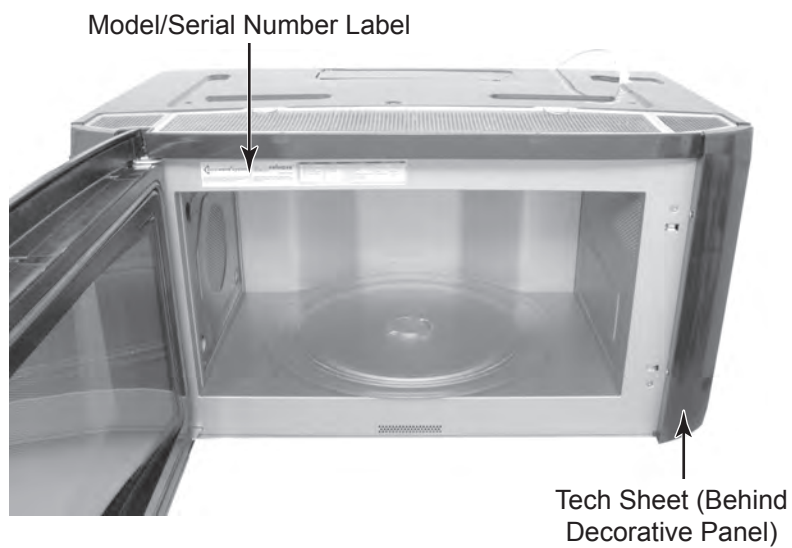

# SPECIFICATIONS

<b>MODEL</b>	<b>GH6208XRQ/B/S</b>
Model Description	Whirlpool Speed Oven in White, Black, Stainless
<b>CONTROL SYSTEM</b>	
Timer:	Yes
Type	Electronic
Limits	90 Min. 00 Sec.
Scale	Linear (Digital)
Operation	Touch Screen LCD Touch Pad Glass
Keypad Disable / Child Lockout Mode	Yes - Cancel Button
Exhaust Fan:	Yes - ON/OFF
Number of Speeds	5-OFF + 4 steps Separate Button
Automatic Turn On Temp	60°C, 140°F
Cooktop Light	Halogen
Settings:	0FF + low-medium-high
Night Light	Yes - Separate Button
Wattage	2 x 10 Watts
Power Failure Indication	Yes
Invalid Data Entry	3 Short Beeps and Indication on Display
Technical Error Indication	Pop-Up Screen "F-" With Error Number and Symbol + Call for Service
Diagnostic System	Yes
Independent Minute Timer	Yes - 4 rapid very short tones
<b>OVEN INTERIOR FEATURES</b>	
Capacity	2.0 Cubic Feet
Finish	Non Stick Coating
MW Cooking Power	1200 Watts (IEC-705 Rating)
Grill Power	1500 Watts
Turntable	Yes - 16" Diameter
Ventilation	Radial blower
Cooling Fan	Automatic - On if oven is operating, off if door open
Interior Light	Halogen
Operation	Automatic with soft On/Off - Turns on when oven door is open or oven is operating. Stays on after cooking cycle ended until door has been opened/ closed or Cancel pressed
Wattage	1 x 10 Watts

<b>MODEL</b>	<b>GH6208XRQ/B/S</b>
<b>DOOR FEATURES</b>	
Stamped Steel	Yes
Window	Curved Glass
Seals	Two Stage - (Capacitive and Reflective)
<b>MICROWAVE/GRILL SYSTEM</b>	
Distribution	Top Feed w/o Stirrer
Magnetron	One - Inverter type
Grill	Halogen/Quartz
<b>SAFETY FEATURES</b>	
Interlock	Three Door/Latch Operated, Primary, secondary, and monitor
Thermal Protectors	Five - Magnetron, Oven Cavity, Hood, Grill, Waveguide
<b>VENTILATION SYSTEM</b>	
Type	Convertible Recirculation, Exhaust Vertical/Horizontal
Duct Outlet Size	3-1/4" H x 10" W
Recirculation CFM Out @ each Speed	200
Exhaust CFM Out @each Speed	300
Noise Level Recirculation	67dBA
Damper	Yes
Odor Removal filter	Yes - (2) Standard Charcoal
Grease Filter	Yes - (2) Dishwasher Safe
Blower Type	Radial
Shipped	Recirculation mode
<b>EXTERIOR FEATURES</b>	
Cooktop Light w/Touch Control	2 Halogen Lamps - 10 Watts - Easy Access-Separate Button
Power Cord Length	3 Feet
<b>OTHER SPECIFICATIONS</b>	
Electrical	120V, Single Phase, 60 Hz, 1800 Watts, For Use With 15 - 20 Amp Circuit
Domestic Use Only	Yes
Agency Approvals	FCC, CDRH, UL, CUL
<b>APPROVED ACCESSORIES</b>	
Exhaust Damper Assembly	Yes (1 Set)
Hardware for Installation	Yes (1 Set)
<b>LITERATURE</b>	
Use & Care Guide	Part No. 8205283
Installation Instructions	Part No. 8205272
Warranty	In Use & Care Guide
Tech Sheet	Part No. 8205285
Job Aid/Service Manual	Part No. 8178545

<b>MODEL</b>	<b>GH7208XRQ/B/T/S/Y</b>
Model Description	Whirlpool Speed Oven with Convection
<b>CONTROL SYSTEM</b>	Sensor
Timer:	Yes
Type	Electronic
Limits	90 Min. 00 Sec.
Scale	Linear (Digital)
Operation	Touch Screen LCD Touch Pad Glass
Display	LCD, White Backlight/3 Shade Blue + White Pantone 293C Background
KeyPad Disable/ Child Lockout Mode	Yes, Press "Cancel" key for 5 seconds
Exhaust Fan:	Yes - ON/OFF-low-high
Number of Speeds	5-OFF + 4 steps Separate Button
Automatic Turn On Temp	60°C, 140°F
Cooktop Light	Halogen
Settings:	OFF + low-medium-high
Night Light	Yes - Separate Button
Wattage	2 x 10 Watts
Power Failure Indication	Yes
Standby Display Power	Yes
Invalid Data Entry	3 Short Beeps and Indication on Display
Technical Error Indication	Pop-Up Screen "F-" With Error Number and Symbol + Call for Service
Diagnostic System	Yes
<b>OVEN INTERIOR FEATURES</b>	
Capacity	2.0 Cubic Feet
Finish	Non Stick Coating
MW Cooking Power	1200 Watts (IEC-705 Rating)
Grill Power	1500 Watts
Convection Element	1600 Watts
Turntable	Yes - 16" Diameter
Ventilation	Radial blower
Cooling Fan	Automatic - On if oven operating, off if door open
Interior Light	Halogen (10 Watt)
<b>DOOR FEATURES</b>	
Stamped Steel	Yes
Window	Curved Glass
Door Screen Size, Dia/Pitch inches	18-7/8" x 7-7/8", 0.06"/0.08"
Seals	Two Stage (Capacitive and Reflective)

<b>MODEL</b>	<b>GH7208XRQ/B/T/S/Y</b>
<b>MICROWAVE/GRILL SYSTEM</b>	
Distribution	Top Feed w/o Stirrer
Magnetron	One - Inverter type
Grill	Halogen/Quartz
<b>SAFETY FEATURES</b>	
Interlock	Three Door/Latch Operated Primary, secondary and monitor
Thermal Protectors	Six - Magnetron, Oven Cavity, Hood, Grill, Convection, Waveguide
<b>VENTILATION SYSTEM</b>	
Type	Convertible Recirculation, Exhaust Vertical/Horizontal
Duct Outlet Size	3-1/4" H x 10" W
Recirculation CFM Out	200
Exhaust CFM Out	300
Noise Level Recirculation	67dBA
Damper	Yes
Blower Type	Radial
Shipped	Recirculation mode
<b>EXTERIOR FEATURES</b>	
Cooktop Light w/Touch Control	2 Halogen Lamps - 10 Watts - Easy Access-Separate Button
Power Cord Length	3 Feet
<b>OTHER SPECIFICATIONS</b>	
Electrical (15-20 Amp circuit)	120V, Single Phase, 60 Hz, 1800 Watts
Domestic Use Only	Yes
Agency Approvals	FCC, CDRH, UL, CUL
<b>APPROVED ACCESSORIES</b>	
Installation Hardware & Damper Assembly	Yes (1 Set)
<b>LITERATURE</b>	
Use & Care Guide	Part No. 8205283
Installation Instructions	Part No. 8205272
Warranty	In Use & Care Guide
JobAid/Service Manual	Part No. 8178545
Tech Sheet	Part No. 8205285

— NOTES —



# INSTALLATION INFORMATION

## INSTALLATION REQUIREMENTS

### INSTALLATION DIMENSIONS

**NOTE:** The grounded 3-prong outlet must be inside the upper cabinet. See “Electrical Requirements” section.

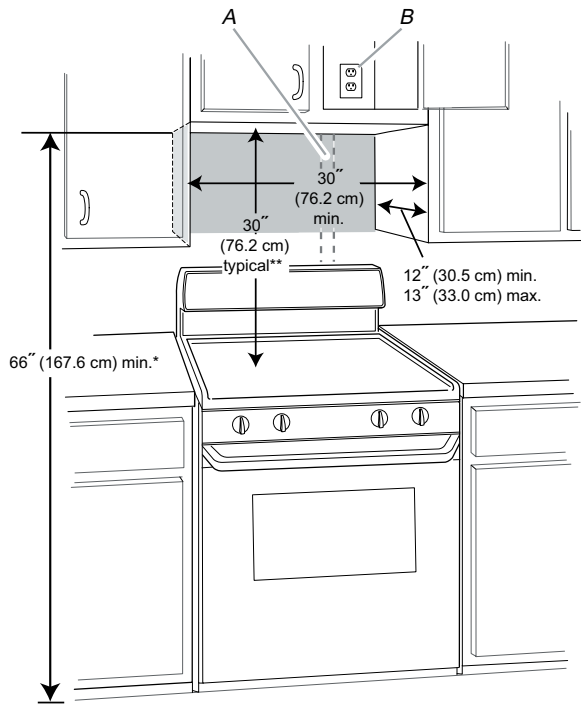

A. 2" x 4" wall stud  
B. Grounded 3 prong outlet

\*For improved use of the product, 69" (175.3 cm) or above is recommended.

\*\*30" (76.2 cm) is typical for 66" (167.6 cm) installation height. Exact dimension may vary depending on type of range/cooktop below.

### PRODUCT DIMENSIONS

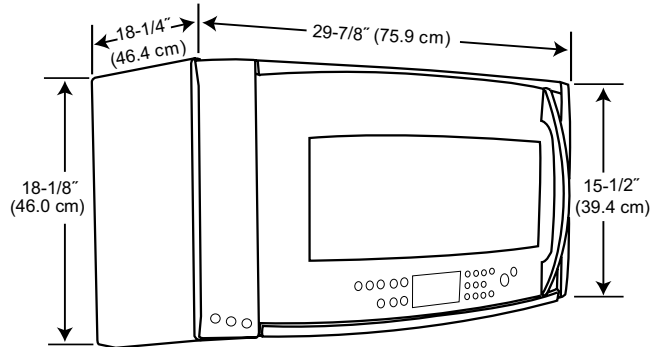

## ELECTRICAL REQUIREMENTS

### **⚠ WARNING**



#### **Electrical Shock Hazard**

**Plug into a grounded 3 prong outlet.**

**Do not remove ground prong.**

**Do not use an adapter.**

**Do not use an extension cord.**

**Failure to follow these instructions can result in death, fire, or electrical shock.**

Observe all governing codes and ordinances. A 120 Volt, 60 Hz, AC only, 15- or 20-amp fused electrical supply (or circuit breaker) is required. (A time-delay fuse or circuit breaker is recommended.) It is recommended that a separate circuit serving only this appliance be provided.

### **GROUNDING INSTRUCTIONS**

- **For all cord connected appliances:**

The microwave oven must be grounded. In the event of an electrical short circuit, grounding reduces the risk of electric shock by providing an escape wire for the electric current. The microwave oven is equipped with a cord having a grounding wire with a grounding plug. The plug must be plugged into an outlet that is properly installed and grounded.

**WARNING:** Improper use of the grounding plug can result in a risk of electric shock. Consult a qualified electrician or serviceman if the grounding instructions are not completely understood, or if doubt exists as to whether the microwave oven is properly grounded.

Do not use an extension cord. If the power supply cord is too short, have a qualified electrician or serviceman install an outlet near the microwave oven.

# INSTALLATION INSTRUCTIONS

## CONVERT OVEN TO EXTERNAL VENTING (WALL OR ROOF VENTING ONLY)

The oven is set for ventless (recirculating) installation. For wall or roof venting, changes must be made to the venting system.

**NOTE:** Skip this section if you are using ventless (recirculating) installation. Keep the damper assembly in case the venting method is changed, or the oven is reinstalled in another location where wall or roof venting may be used.

To prepare the oven for wall or roof venting, the vent deflector (L-shaped metal bar) must be installed, and the appropriate damper vent opening must be uncovered.

### To Install Vent Deflector:

1. Gently pull the rings and lift vent screen from the top of the oven.

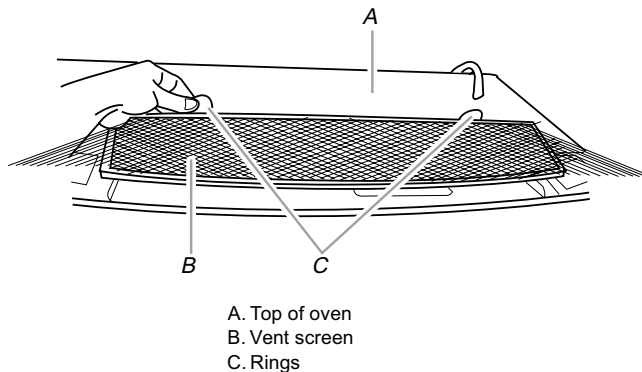

2. With vent deflector oriented as shown (wide side down), slide it back and under the back edge of the vent opening.

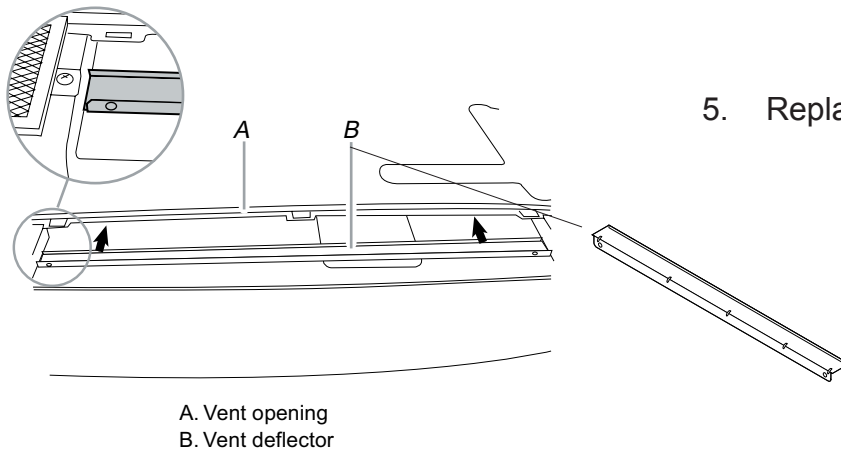

3. When the vent deflector is as far back as it can easily slide, flip it so that the wide side is to the back of the oven, and the narrow side (with holes) is down. The vent deflector holes should align with the mounting holes in the oven vent opening, as shown in inset.

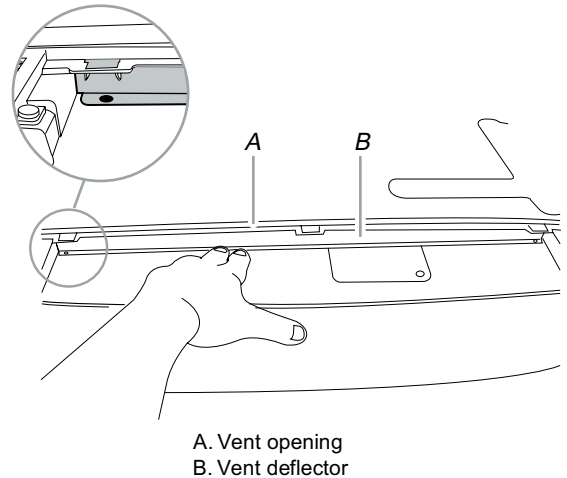

4. Secure vent deflector with 2 mounting screws (1 on each end).

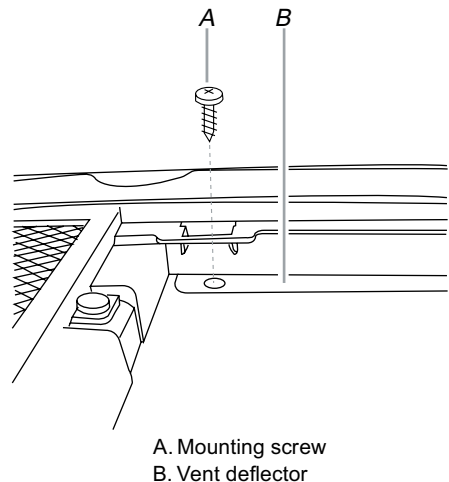

5. Replace vent screen.

## REPLACEMENT PARTS

If any of the installation hardware needs to be replaced, call us at our toll free number listed in the Use and Care Guide, and reference the appropriate part number listed here:

Damper Assembly—Part Number 8205558

Mounting Plate—Part Number 8205978

Upper Cabinet Template—Part Number 8205274

Mounting Screw Kit (includes parts A-G in “Parts Supplied” section)—Part Number 8205979

Vent Deflector—Part Number 8205980

## ACCESSORIES

Filler Panel Kits are available from your dealer to use when installing this oven in a 36” (91.4 cm) or 42” (106.7 cm) wide opening. The filler panels come in pairs. Each panel is 3” (7.6 cm) wide.

See your authorized dealer or service center for details.

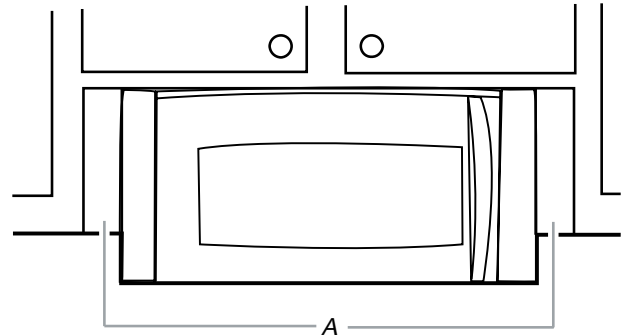

A. Filler panels

Filler Panel Kit Number	8171336	White
	8171337	Black
	8171338	Biscuit
	8171339	Stainless Steel
	99403	Almond

# PRODUCT OPERATION

## PARTS AND FEATURES

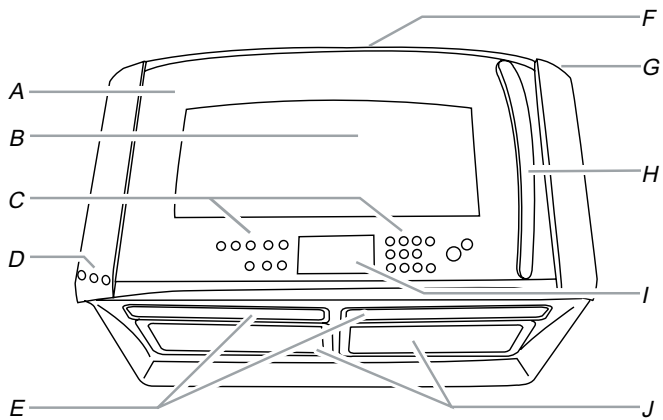

- A. Oven door
- B. Metal-shielded window
- C. Control panel
- D. Fan, Light and Night Light buttons
- E. Halogen cooktop lights (2)
- F. Exhaust vent (for recirculation) (top surface of oven)
- G. Intake vent
- H. Door handle
- I. Interactive touch display
- J. Grease and charcoal filters (2 each)

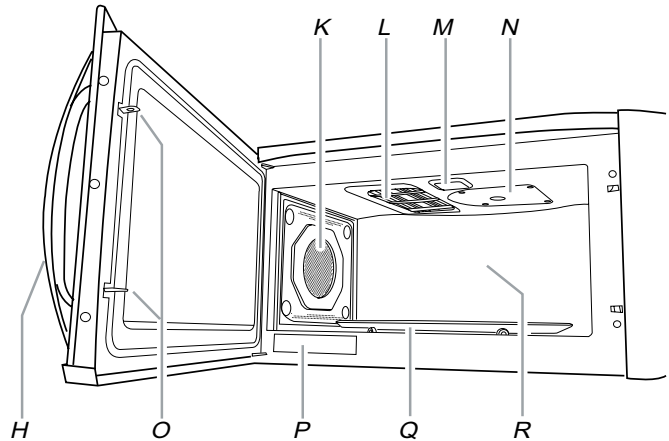

- K. Convection element and fan (behind screen)
- L. Grill element
- M. Oven light
- N. Microwave inlet cover
- O. Door safety lock system
- P. Model and serial number plate
- Q. Turntable
- R. Cavity recess

### OVEN CAVITY COATING

The oven has a durable, nonstick coating that resists soil buildup by making cleaning easier than in conventional microwave ovens.

### MICROWAVE SYSTEM ACCUWAVE® TECHNOLOGY

The microwave system delivers a constant stream of microwave power – true high, medium and low power.

Typically, microwave ovens operate on HIGH power only. For example, to achieve a 50% power level (“medium”) in a typical microwave oven, the oven operates 50% of the time at HIGH power and 50% of the time OFF.

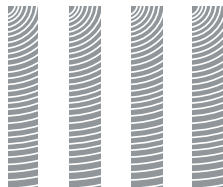

In contrast, ovens utilizing this microwave system deliver the selected power level continuously. This constant stream of microwave power helps to minimize overcooking of foods and messy food spatters.

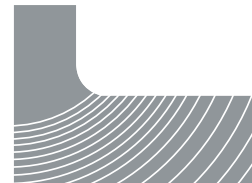

## SENSOR COOKING

The microwave system features the 6th SENSE™ cooking system. A humidity sensor in the oven cavity detects moisture and humidity emitted from food as it heats. The sensor adjusts cooking times to various types and amounts of food. Sensor cooking takes the guesswork out of microwave cooking.

## GRILL ELEMENT

The oven uses a 1,000-watt halogen bulb with a 500-watt quartz bulb to serve as the grill element for various cooking functions.

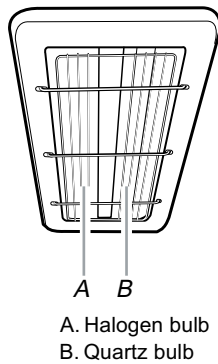

When the element is in use, the halogen bulb glows very brightly, while the glow of the quartz bulb is barely—if at all—visible. The oven cavity and door will become hot. The use of oven mitts is recommended.

## CONVECTION ELEMENT AND FAN

The oven's convection system is composed of a convection element, which heats in conjunction with the convection fan for true convection cooking. The convection system is embedded in the wall of the oven cavity, behind the protective screen. The oven cavity and door will become hot. The use of oven mitts is recommended.

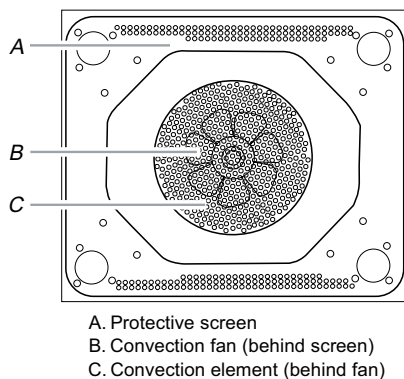

## TURNTABLE

The turntable can rotate in either direction to help cook food more evenly. Do not operate the oven without having the turntable in place.

### To Install:

1. Remove tape from the hub.
2. Place the support on the oven cavity bottom.
3. Place the turntable on the support.

Fit the raised, curved lines in the center of the turntable bottom between the three spokes of the hub. The rollers on the support should fit inside the turntable bottom ridge.

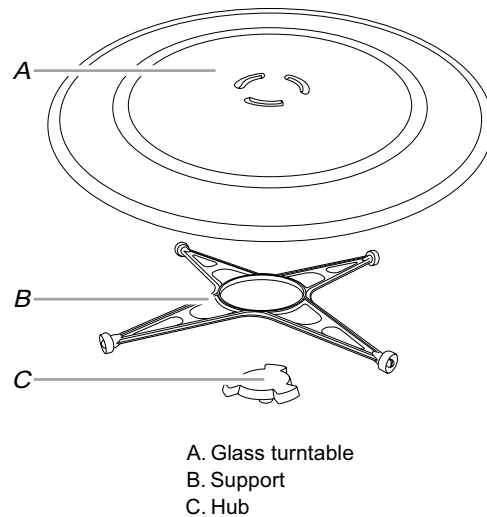

### Turning Off The Turntable

The turntable can be turned off for manual cooking cycles only. This is helpful when cooking with plates that are larger than the turntable, or when cooking with two plates that are side by side.

When the manual cycle is over, the turntable will automatically default to the “ON” mode.

**To Turn On/Off:**

1. Touch TURNTABLE ON/OFF (see C below). The display shows the Turntable On/Off screen.

2. Select “Off,” then touch “OK.” The turntable off indicator will appear on the display.

Repeat to turn the turntable back on.

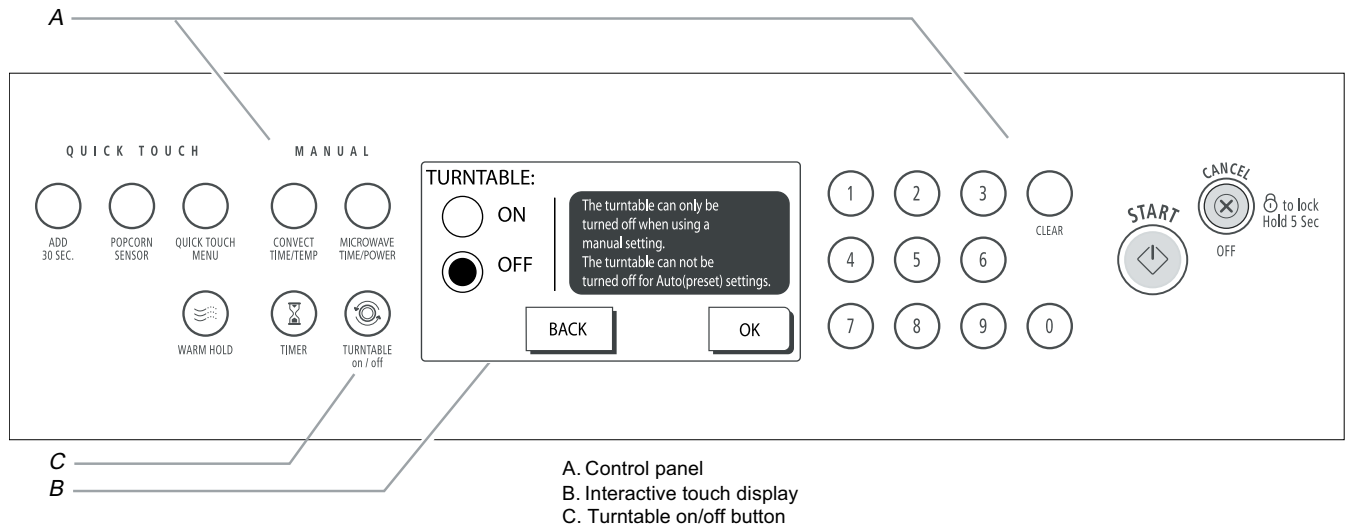

# OVEN CONTROL

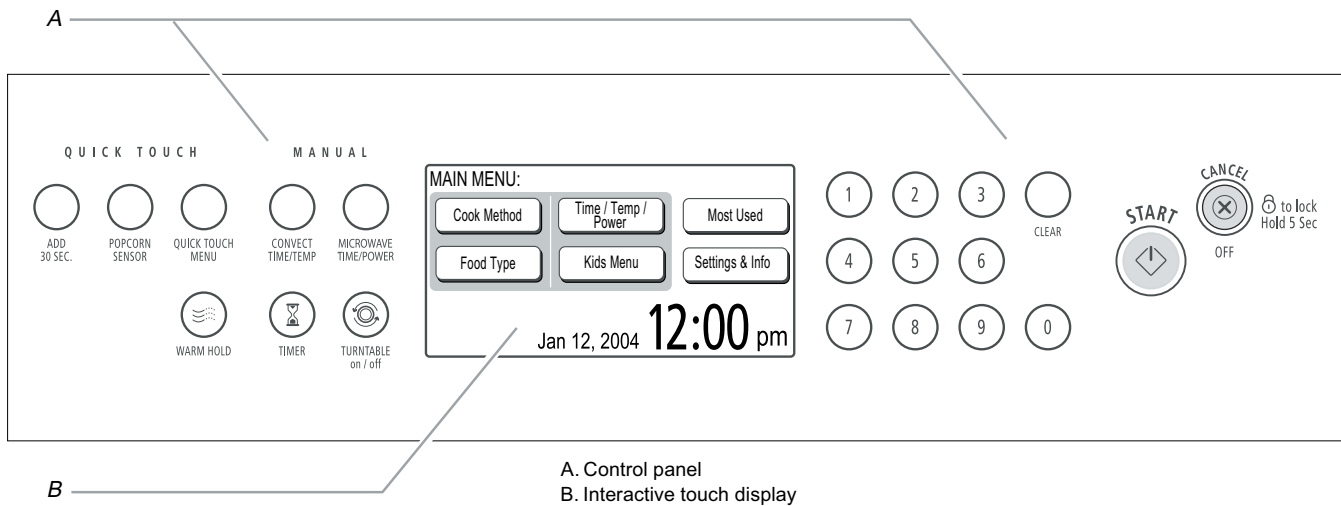

The oven's controls are accessed through its control panel and interactive touch display.

## CONTROL PANEL

The control panel houses basic controls and Quick touch controls. The control pads are very sensitive, and require only a light touch to activate.

## INTERACTIVE TOUCH DISPLAY

The display area functions as both a display and an interactive, menu-driven touch control. It is designed to be easily navigable, guiding you through the menus, offering multiple selections, accepting your input and executing your commands. It also provides instructions, tips, and displays.

### Display

When power is first supplied to the oven, the welcome screen appears. You will be asked whether you would like to set the clock. Touch "Yes" and set the clock (see "Clock" section on page 3-6), or touch "No" and the time will default to 12:00 p.m. If the welcome screen appears at any other time, a power failure has occurred. Reset the clock if needed.

When the oven is not in use (in standby mode), the display shows the Main Menu and the date and time of day, if they are set to be displayed. (see "Clock" and "Date" sections on page 3-6). After 2 minutes of inactivity, the display will go into sleep mode (see "Display Backlight" section on page 3-6).

During programming, the display shows menus, servings and weights, cooking time/power/temperature settings, preheating instructions, and/or cookware and preparation instructions.

If an attempt is made to start the oven more than 5 minutes after the food has been placed inside, a screen will appear, and 4 tones will sound, indicating that the door needs to be opened and closed again before the oven will accept the start command.

During a cooking cycle, the display shows a progress bar (sensor functions only, see "Progress Bar" section on page 3-10), cooking animation (see "Cooking Animation" section on page 3-10), and the countdown of cook time remaining. The display will also give prompts to tend to the food during certain automatic cycles.



## Touch Screen

The LCD touch screen is used to make menu selections, adjust settings and input commands.

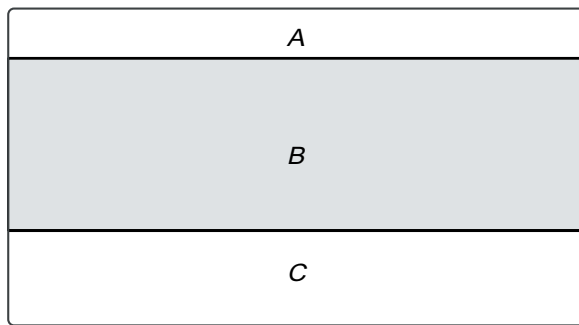

- A. Title/description region
- B. Menu and selection/settings input region
- C. Command input region

Menu selections and input adjustments are made in the center portion of the screen, and the command inputs (start, continue, back, cancel, etc.) are made in the bottom portion of the screen. Screen titles and descriptions are displayed in the top portion of the screen, which accepts no input. A light- to medium-pressure touch of the fingertip will activate the menu choice.

## MAIN MENU

The Main Menu is displayed on the default screen.

From the Main Menu, all automatic cooking programs can be activated; all manual cooking can be programmed; settings can be adjusted; and instructions, preparation and tips can be accessed.

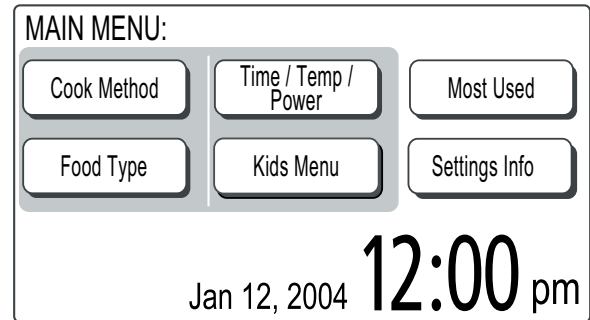

## CLOCK

This is a standard 12-hour clock (12:00 AM-11:59 PM), or a 24-hour clock (0:00-23:59). When power is first supplied to the oven, or after a power failure, the “Welcome” screen will appear, asking whether you would like to set the clock. If you choose to set the clock at that time, the display will take you directly to the Clock screen. If you choose not to set the clock, the time of day will default to 12:00 p.m., and the clock will be displayed and continue to keep time. The clock format defaults to 12-hour, and to Daylight Savings OFF.

### To Set Clock:

1. On Main Menu, touch “Settings & Info.”
2. On Settings & Info screen, touch “Clock.”
3. On Clock screen, touch “Adjust Time,” and follow the instructions to set the time of day, and select AM or PM (if setting in standard format).

**To Change Format/Daylight Savings Settings:** On Clock screen, select either “Standard” (12-hour) or “Military” (24-hour), and/or select “Daylight Savings ON” or “Daylight Savings OFF,” then touch “OK.”

**To Hide Clock:** On Clock screen, touch “Adjust Time,” and then touch “Hide Clock.” The display will immediately return to the Main Menu.

## DATE

The date may be set and displayed on the Main Menu screen. The default setting is Jan. 1.

### To Set Date:

1. On Main Menu, touch “Settings & Info.”
2. On Settings & Info screen, touch “Date.”
3. On Date screen, use Month “+” or “-” and Day “+” or “-” controls to set the month and day.

4. Touch “Adjust Year,” and change the year, if desired.

**To Hide Date:** On Date screen, touch “Hide Date.” The display will immediately return to the Main Menu. Repeat to display the date.

## DEMO MODE

The Demo Mode highlights the features and capabilities of the oven in a slide show on the display.

### To Activate Demo Mode:

1. On the Main Menu, touch “Settings & Info.”
2. On Settings & Info screen, touch “Demo Mode.”  
The demonstration immediately begins. You can move forward or back in the demonstration by touching “Next Page” or “Back,” or wait for the screen to advance. When the demonstration is over, it automatically loops back to the beginning and starts again.
3. Touch “Cancel Demo” on the touch screen, or touch CANCEL control to cancel Demo Mode and return the display to the Main Menu.

## DISPLAY BACKLIGHT

Display backlight may be set to reduce brightness or to turn off during sleep mode.

Sleep mode is an energy-saving feature that darkens the display backlight after 2 minutes of inactivity. During sleep mode, only the time and date are visible, along with instruction to touch the screen to reactivate the Main Menu.

### To Set Display Backlight:

1. On Main Menu, touch “Settings & Info.”
2. Touch “Display Backlight.”
3. Select setting: reduce after 2 minutes or off after 2 minutes.
4. Touch “OK.”

## DISPLAY CONTRAST

Display contrast has 11 settings, ranging from minimum to maximum.

### To Set Display Contrast:

1. On Main Menu, touch “Settings & Info.”
2. Touch “Display Contrast.”
3. Using “+” and “-” controls, increase or decrease the contrast.
4. Touch “OK.”

## LEARNING MODE

The Learning Mode is ideal for learning how to use the oven. When set, functions can be entered, with real displays and tones, without actually turning on the microwave generator (magnetron), grill element or convection element. While functions are operating in the Learning Mode, the oven light will come on, the fan will run, and the turntable will rotate (if set ON).

While the Learning Mode is active, the Learn indicator is visible in the lower, left command area. The indicator is visible while the oven is in stand-by mode, during programming, and during Settings & Info menu navigation.

The Learning indicator shares the lower, left command area with the Timer countdown if both are in operation.

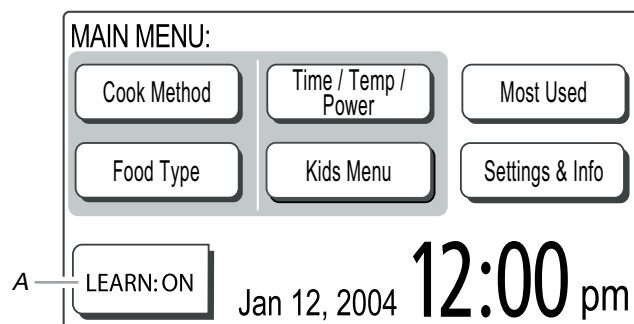

A. Learning mode indicator

### To Activate Learning Mode:

The oven must be off.

1. On the Main Menu, touch “Settings & Info.”
2. On Settings & Info screen, touch “More Choices.”
3. Touch “Learning Mode.”
4. Touch “On” or “Off” to set.
5. Touch “OK.”

## TONES

Tones are audible signals, indicating the following:

### One Tone

- Valid entry (short tone)

### Two Tones

- Between stages (short tones)
- Reminder (long tones), repeat each minute for 10 minutes after the end-of-cycle tones
- End of Timer countdown
- Hidden feature entered or exited (very short, quick tones)

### Three Tones

- Invalid entry (very short, quick tones)
- Retry Error

### Four Tones

- End of cycle (2 short tones, followed by 2 longer tones)
- Interruption, tend to food (short tones)
- Attention - door needs to be opened and closed

### To Adjust Tone Volume:

1. On Main Menu, touch “Settings & Info.”
2. On Settings & Info screen, touch “More Choices.”
3. Touch “Volume.”
4. Using “+” and “-” controls, increase or decrease the volume setting, or turn the tones off.
5. Touch “OK.”

## START

The START control will start any function.

If non-sensor cooking is interrupted, touching the START control pad will resume the preset cycle.

For added convenience, the “Start” touch pad is also available on some display screens, and provides the same function as the START control pad.

## CANCEL

The CANCEL control stops all functions except for the Timer and Learning Mode, and cancels programming in progress.

The oven will also turn off when the door is opened. Close the door and touch START control or “Continue” on the touch screen to resume the cycle. A sensor cooking cycle may not be resumed if interrupted by opening the door.

## CLEAR

During programming the CLEAR control changes the numeric programming values, such as minutes, seconds and cook power that are active in the display to their default value. For example, while entering a cook time, touching CLEAR will change the time you have already entered to “0:00.” The CLEAR control gives an invalid signal (see “Tones” section) if touched during cooking.

## TIMER

The Timer can be set in minutes and seconds, up to 99 minutes, 59 seconds, and counts down the set time.

**NOTE:** The Timer does not start or stop the oven.

The Timer countdown can be seen in full screen or in minimized view. In minimized view, the countdown is always visible.

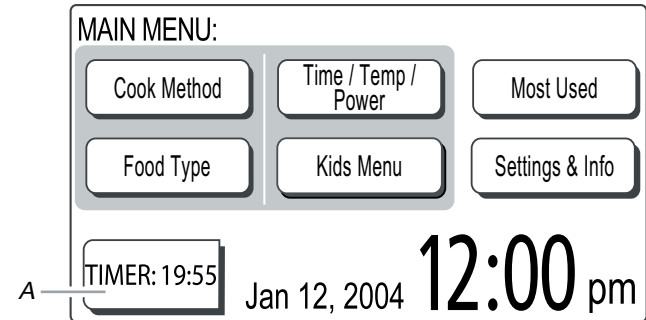

A. Minimized Timer countdown

While the Timer is in use, the oven can still operate. During an oven operation, the Timer countdown will be minimized. If the Timer ends while oven is still operating, the end-of-Timer tones will sound, and the set operating mode will remain active on the screen.

### To Set Timer:

1. Touch TIMER control.
2. Using the “+” and “-” controls or the number pads, enter desired time in minutes and seconds, and then touch “Start Timer.”

The countdown will be in full screen view.

3. Touch “OK” to minimize the countdown.

To see the countdown in full screen view, touch the minimized Timer countdown pad on the touch screen, or TIMER control.

The time can be reset during the countdown by touching TIMER, entering a new time, then touching “OK,” or the START control.

**To Cancel:** Touch TIMER control, then touch “Cancel Timer.”

## CHILD LOCK

The Child Lock disables all controls to prevent unintended use of the oven. The only control that will function while the Child Lock is active is the CANCEL pad on the control panel.

Child Lock activation is possible only when the oven is in standby mode.

**To Activate Child Lock:** Touch and hold CANCEL control for 5 seconds. Two tones will sound, and the display will show the padlock icon.

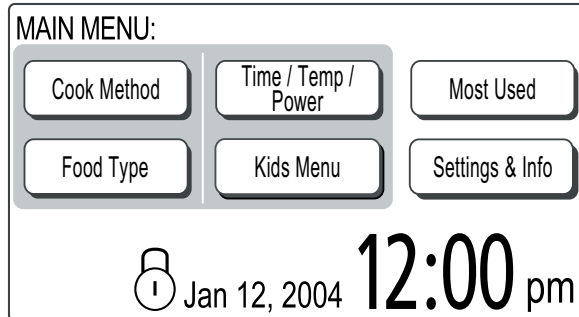

If any controls are touched while the Child Lock is active, the "Child Lock is set" reminder screen appears for 5 seconds.

**To Deactivate Child Lock:** Touch and hold CANCEL control for 5 seconds. Two tones will sound, and the padlock icon will be removed from the display.

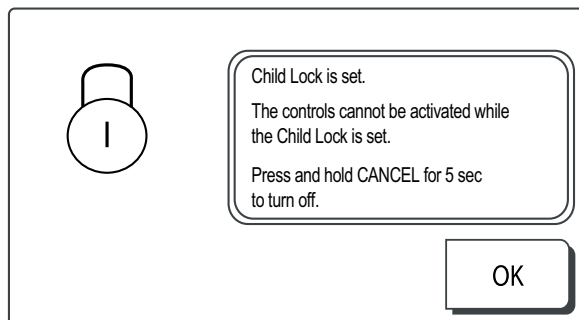

## VENT FAN

The vent fan has 4 speeds: boost, high, medium and low.

To protect the oven, the vent fan will automatically turn on at high speed if the temperature from the range or cooktop below gets too hot. It may stay on for up to 1 hour to cool the oven. When this occurs, the vent fan cannot be turned off. If the Fan button is pressed, a reminder will appear in the display, explaining the automatic fan activation.

**To Operate Vent Fan:** Press FAN repeatedly to cycle through the settings: low, medium, high, boost and off. The status will be displayed for a few seconds while the settings are being adjusted.

## COOKTOP LIGHT

The cooktop light has 3 brightness settings: high, medium and low.

**To Turn Light On/Off:** Press LIGHT button repeatedly to cycle through the settings: low, medium, high and off. The status will be displayed for a few seconds while the settings are being adjusted.

## NIGHT LIGHT

The Night Light control button turns on the cooktop light at the lowest setting. While the Night Light is on, the Light control may still be used to brighten the cooktop. When the cooktop light is turned off, the Night Light will still be on. The Night Light can be turned on or off only with the Night Light button. The status will be displayed for a few seconds when the Night Light is turned on or off.

## COOKING ANIMATION

The cooking animation appears during any cooking cycle, whether automatic or manual. The animation shows what type of cooking is taking place.

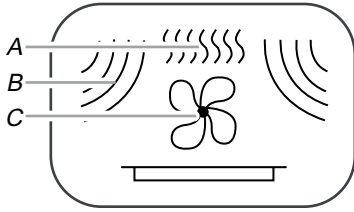

- A. Cooking with grill element
- B. Cooking with microwaves
- C. Cooking with convection

## PROGRESS BAR

The progress bar is a visual picture of the estimated running time of a sensor cooking cycle. It will appear at the beginning of sensor cooking functions. Vertical bars appear below the word “Sensing,” and show progress by the darkening of the bars left to right. Some time after the progress bar appears, it may be replaced by “Maximum Time Remaining” indicator and the estimated remaining time, which may fluctuate often. When sensing is finished, “Time Remaining” will appear with the actual remaining cook time.

The progress bar will also appear during oven preheating.

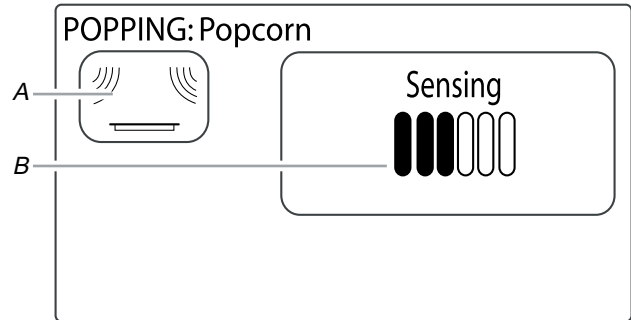

- A. Cooking animation
- B. Progress bar

# USING THE QUICK REFERENCE GUIDE

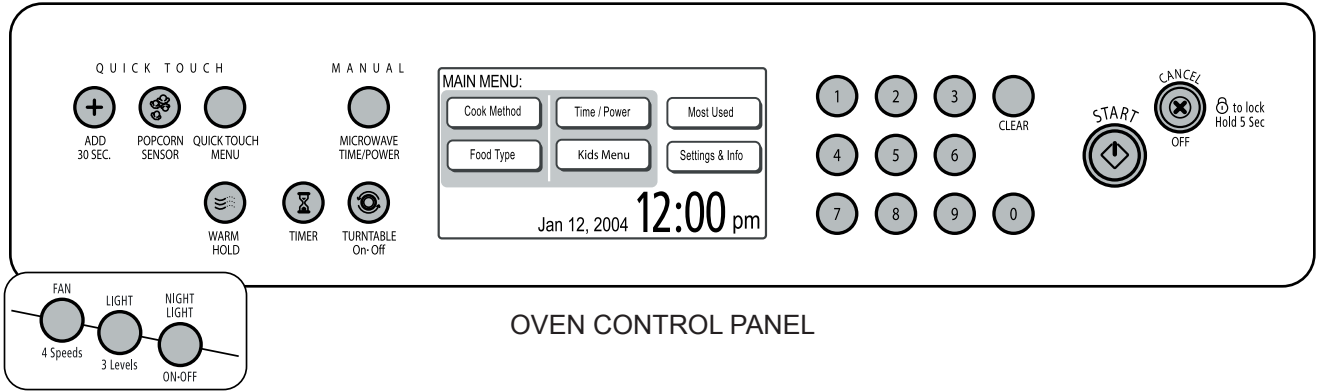

OVEN CONTROL PANEL

## PUSHBUTTON CONTROLS



## Quick Reference Guide

### Whirlpool® Premium Speedcook Oven

Use this as a quick reference when using your Whirlpool® Premium Speedcook oven. For more information, see the Use and Care Guide.

## Quick Tips

SETTING	HOW TO
TO SET CLOCK	Touch “Settings & Info” on Main Menu, then touch “Clock,” then follow screen prompts to set hour, minutes, Standard (12-hour) or Military (24-hour) display and Daylight Saving Time on or off.
TO SET TIMER	Touch TIMER control, use “+” or “-” or touch number pads to set minutes and seconds, then touch “Start Timer.”
TO SET FAN	Press FAN button repeatedly to cycle through the 4 speeds. Press FAN a fifth time to turn off.
TO SET COOKTOP LIGHT	Press LIGHT button repeatedly to cycle through the settings: high, medium and low. Press LIGHT a fourth time to turn off.
TO SET NIGHT LIGHT	Press NIGHT LIGHT to turn Cooktop Light on at its lowest setting. Press NIGHT LIGHT a second time to turn off. (Cooktop Light may still be used at higher settings, and turned off without turning off the Night Light.)
TO SET CHILD LOCK	Touch and hold CANCEL control for 5 sec. Tones will sound, and the display will indicate the lock is active. Repeat to deactivate.
TO SET MANUAL MICROWAVE-ONLY COOK TIME AND POWER	Touch MICROWAVE TIME/POWER control and use “+” or “-” or touch number pads to set cook time in minutes and seconds. Touch “Power: 100%,” then use “+” or “-” or touch number pads to set cook power, and then touch “Start” on the touch screen or START control.

## Accessory Use

<b>CYCLE TYPE</b>	<b>ACCESSORY: DESCRIPTION</b>
SIZZLE PAN CYCLE	Sizzle Pan: Use detachable handle to remove from oven.
GRILL CYCLE	Grill rack with Sizzle Pan underneath: Place food directly on rack.
BOIL & SIMMER CYCLE	Steamer base and lid
STEAM CYCLE	Steamer base, insert and lid
REHEAT CYCLE	Cooking Rack: for two-level reheating. Remove rack at end of cycle.

## Quick Touch Controls

<b>CONTROL</b>	<b>DESCRIPTION</b>	<b>HOW TO USE</b>
ADD 30 SEC.	Programs oven for 30 sec at 100% microwave power.	Touch control to start a 30-sec cycle. Touch control repeatedly to add cook time in 30-sec increments to a running manual cycle.
POPCORN SENSOR	Senses and pops commercially packaged microwave popcorn.	Touch control. Sensing begins immediately.
QUICK TOUCH MENU	Provides shortcuts to 11 common microwave-only program cycles: Baked Potato, Beverage, Leftover Casserole, Dinner Plate, Frozen Entrée, Pizza Leftover, Canned Vegetable, Fresh Vegetable, Frozen Vegetable, Spaghetti and Instant White Rice.	Touch control, select food item, select quantity, if needed, and then touch "Start" on the touch screen or START control.

## Manual Control

<b>CONTROL</b>	<b>DESCRIPTION</b>	<b>HOW TO USE</b>
MICROWAVE TIME/POWER	Activates the manual microwave cooking programming mode.	Touch control, follow screen prompts to enter cook time and adjust the microwave power, if needed, then touch "Start" on the touch screen or START control.



# COMPONENT ACCESS

This section instructs you on how to service each component inside the Speedcook Microwave Oven with Convection. The components and their locations are shown below.

## COMPONENT LOCATIONS

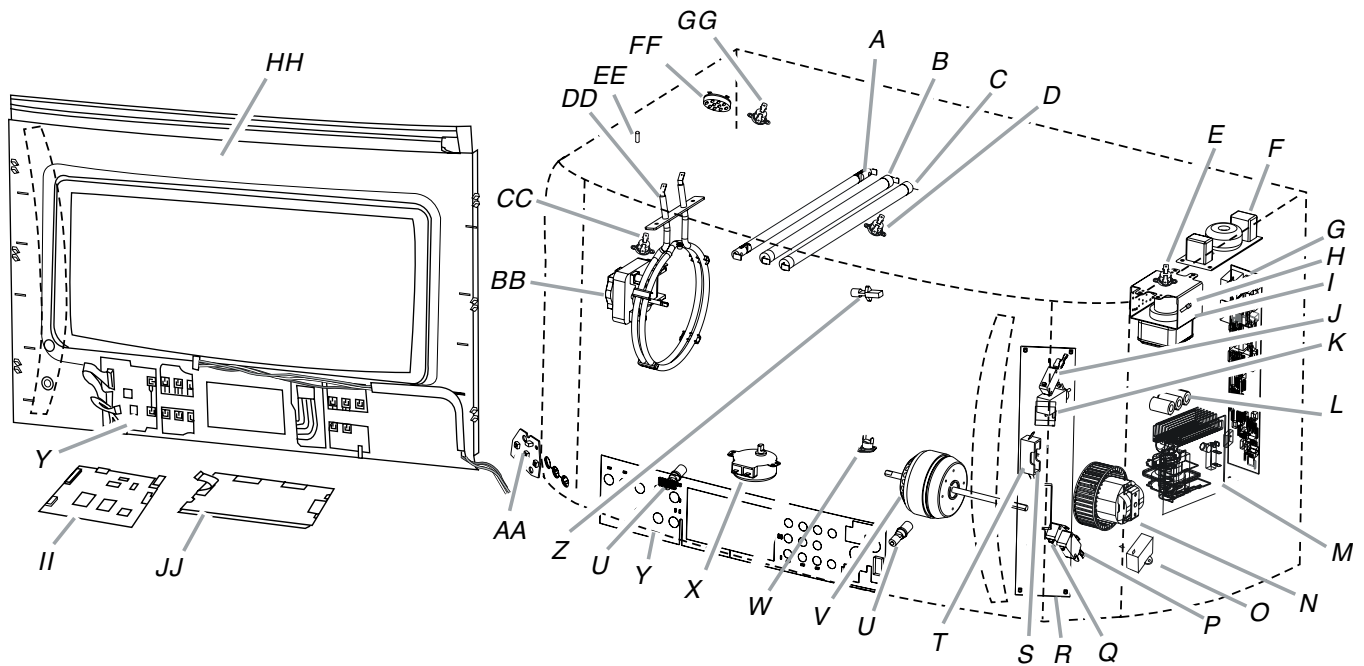

- |  |                                      |                                       |
|--|--------------------------------------|---------------------------------------|
| A. Halogen grill element               | N. Cooling fan motor                 | AA. Hood/light switch                 |
| B. Softstart quartz tube               | O. Motor capacitor                   | BB. FC motor                          |
| C. Quartz grill heater                 | P. Monitor interlock switch          | CC. FC thermostat—opens at 329°F      |
| D. Grill thermostat—opens at 293°F     | Q. Primary interlock switch          | (165°C), closes at 257°F (125°C)      |
| (145°C), closes at 158°F (70°C)        | R. Relay control board               | DD. FC ring heater                    |
| E. Waveguide thermostat—opens at 257°F | S. Line fuse (20 amp)                | EE. FC thermistor                     |
| (125°C), closes at -63.4°F (-53°C)     | T. Fuse holder                       | FF. Humidity sensor                   |
| F. AC line filter                      | U. Hood (cooktop) lamps              | GG. Cavity thermostat—opens at 329°F  |
| G. Relay board                         | V. Hood exhaust fan motor            | (165°C), closes at -22°F (-30°C)      |
| H. Magnetron thermistor                | W. Base thermostat—closes at 140°F   | HH. Door control assembly (back view) |
| I. Magnetron                           | (60°C), opens at 104°F (40°C)        | (includes the touch panel board       |
| J. Secondary interlock switch          | X. Turntable motor                   | only)                                 |
| K. FC thermoactuator                   | Y. Touch panel board (back and front | II. UIB (user interface board)        |
| L. Ferrite ring                        | views)                               | JJ. LCD module                        |
| M. Inverter                            | Z. Cavity lamp                       |                                       |

FC = Forced Convection

## REMOVING THE BOTTOM COVER

### **⚠ WARNING**



#### **Electrical Shock Hazard**

**Disconnect power before servicing.**

**Replace all parts and panels before operating.**

**Failure to do so can result in death or electrical shock.**

1. Unplug microwave oven or disconnect power.
2. Remove the twelve T10 torx screws from the bottom cover.

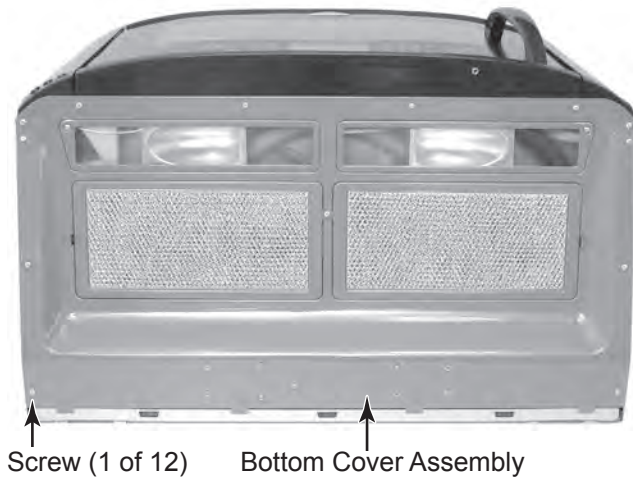

3. Partially lower the front of the cover and disconnect the connector from the turntable motor terminals, then lower the cover the rest of the way.
4. Disconnect the power connector from the bottom of the microwave oven.
5. Unhook the bottom cover assembly from the microwave oven and remove it.

Turntable Motor Connector

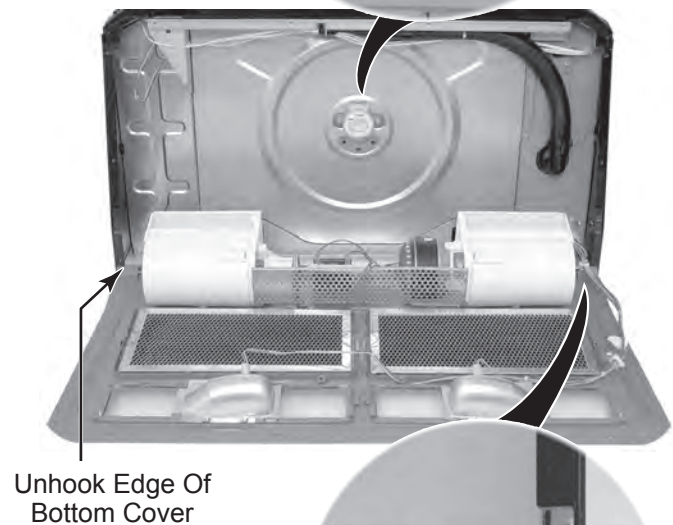
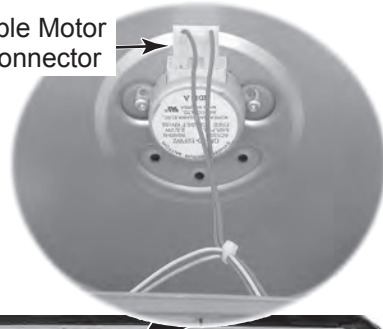

Power Connector

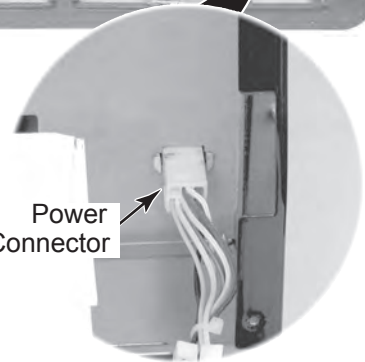

# REMOVING A HOOD LAMP SOCKET, BASE THERMOSTAT, & EXHAUST FAN MOTOR

## ⚠ WARNING



**Electrical Shock Hazard**  
**Disconnect power before servicing.**  
**Replace all parts and panels before operating.**  
**Failure to do so can result in death or electrical shock.**

1. Unplug microwave oven or disconnect power.
2. Lower the bottom cover (see page 4-2 for the procedure).

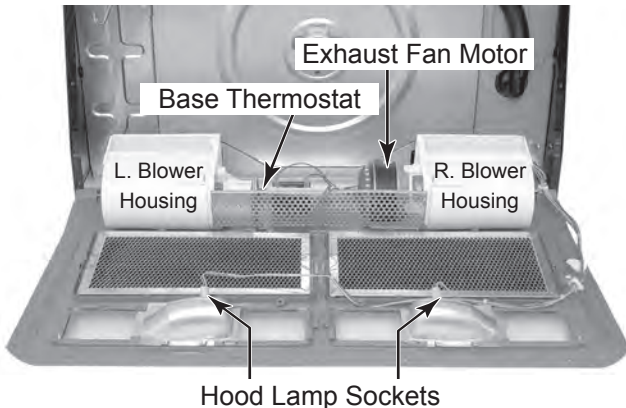

3. **To remove a hood lamp socket:**
  - a) Twist the socket and align the two tabs with the hole slots, then pull the socket and bulb out of the light shield.
  - b) Pull the bulb so the pins are out of the socket holes and remove the bulb.

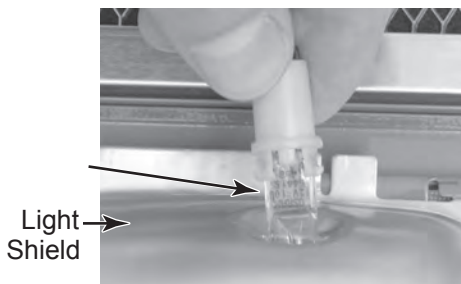

4. **To remove the base thermostat:**
  - a) Disconnect the two wire connectors from the base thermostat terminals.
  - b) Remove the two screws from the base thermostat and remove the thermostat.

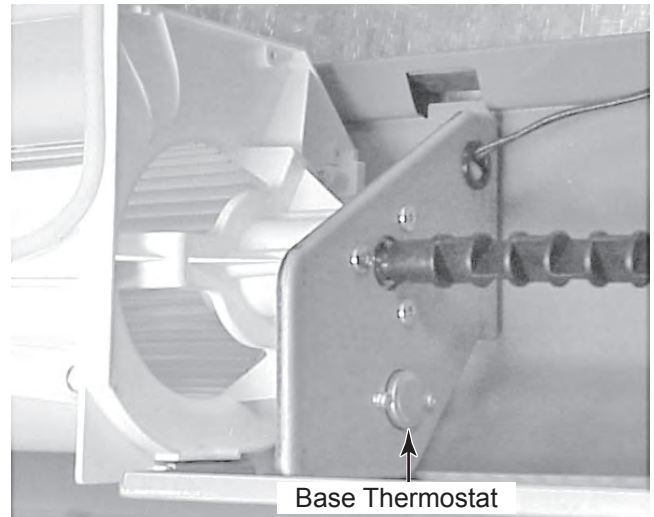

5. **To remove the exhaust fan motor:**
  - a) Remove the bottom cover assembly from the microwave oven (see steps 4 and 5 on page 4-2).
  - b) Cut the wire tie from around the exhaust fan motor wires, and disconnect the motor connector from the harness.

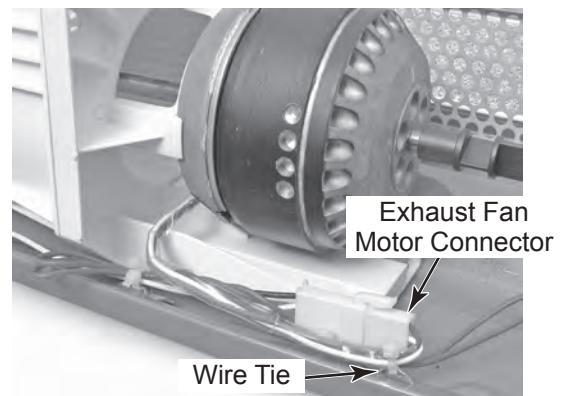

**Continued on the next page.**

- c) Lift the bottom cover and remove the four indicated screws from the exhaust motor and U bracket.

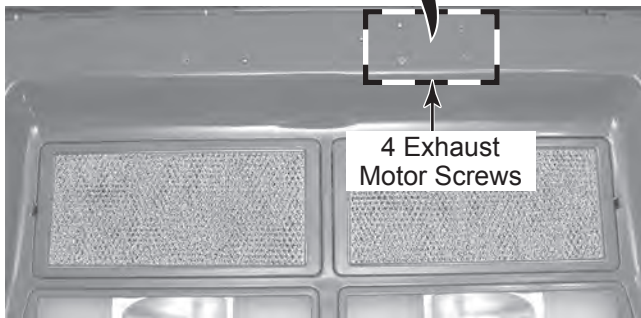
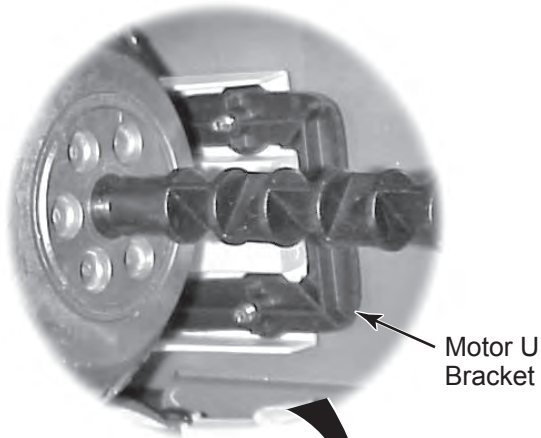

- d) Pull the exhaust fan motor shaft off the coupler.

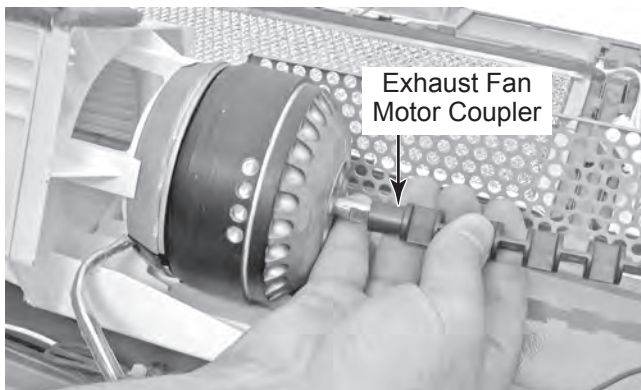

- e) Remove the two T10 torx screws from the exhaust fan housing, and remove the housing from the motor and fan.  
 f) Pull the blower off the motor shaft.

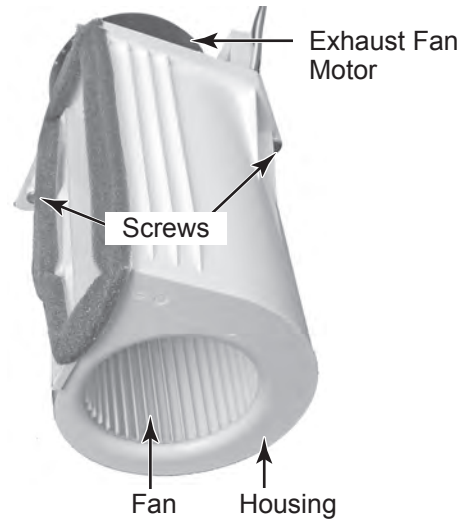

- g) Remove the four screws from the housing cover and remove it from the motor.

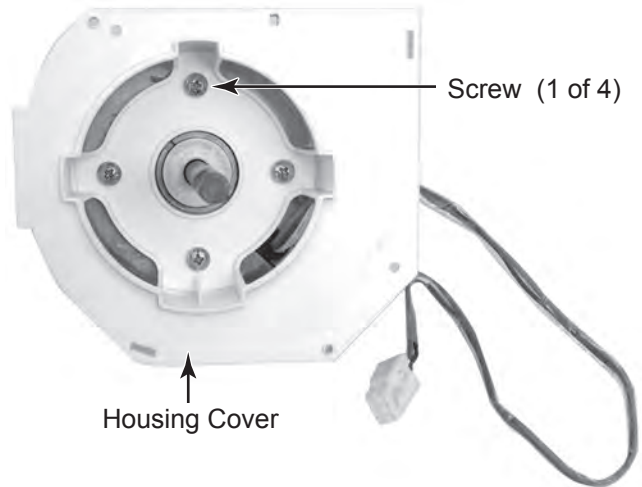

## REMOVING THE TURNTABLE MOTOR & THE AIR TUBE & VENT BASE

### ⚠ WARNING



#### Electrical Shock Hazard

**Disconnect power before servicing.  
Replace all parts and panels before operating.**

**Failure to do so can result in death or electrical shock.**

1. Unplug microwave oven or disconnect power.
2. Remove the bottom cover (see page 4-2 for the procedure).
3. **To remove the turntable motor**, remove the two T10 torx screws and washers.

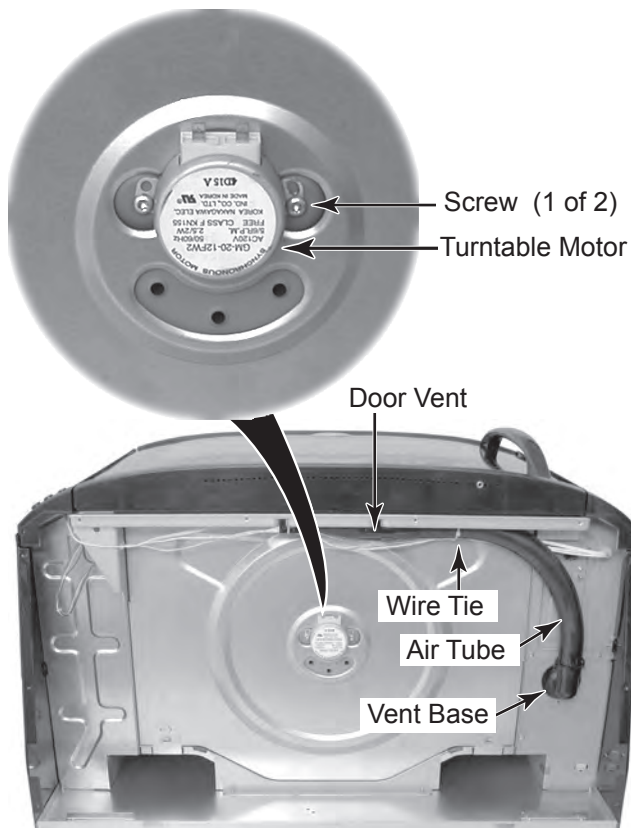

4. **To remove the air tube & vent base:**

- a) Pull out on the two clips, and pull the end of the air tube off the 90° vent base.
- b) Cut the wire tie from around the air tube (see the left photo), and pull the end of the air tube out of the door vent.
- c) Turn the 90° vent base to the right (clockwise) to unlock the four tabs from the slots in the chassis, and pull the base off the chassis.

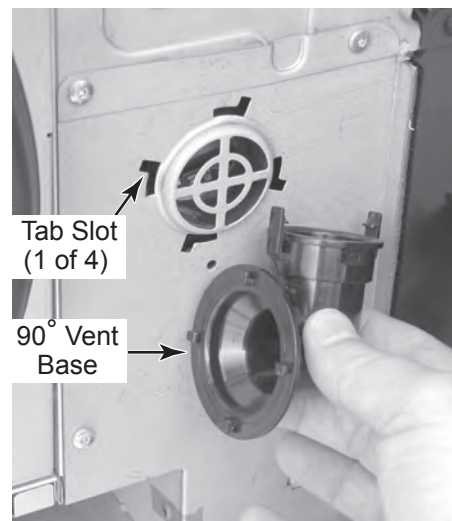
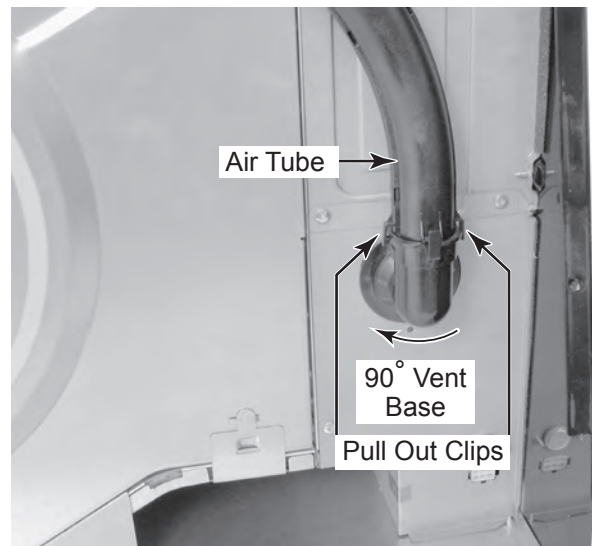

**Continued on the next page.**

**REASSEMBLY NOTE:** When you reinstall the air tube on the 90° vent base, twist the tube so that the two tabs are out of alignment with the two locking arms on the vent base. Slide the tube into the base, and allow the tube to untwist so that the tabs clip into the arms and lock into place.

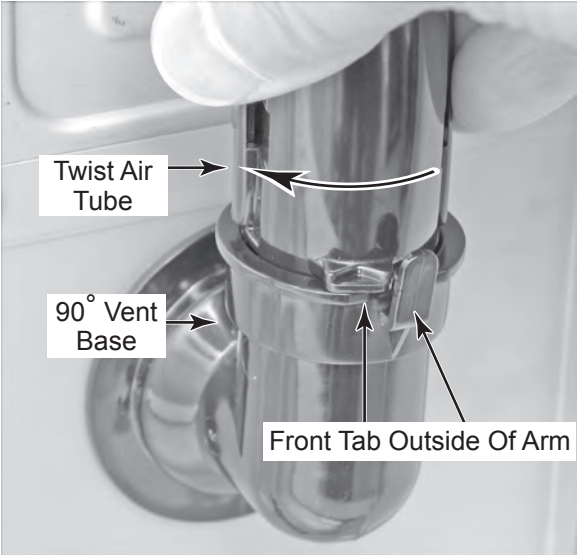

# REMOVING THE RELAY CONTROL BOARD AND LINE FUSE

## **⚠ WARNING**



**Electrical Shock Hazard**  
**Disconnect power before servicing.**  
**Replace all parts and panels before operating.**  
**Failure to do so can result in death or electrical shock.**

1. Unplug microwave oven or disconnect power.
2. Open the microwave oven door.
3. Pull the two tabs and remove the center air flow screen from the top of the cabinet.

Center Air Flow Screen



4. Remove the four indicated screws from the right panel cover, then pull the cover forward, and remove it.
5. Remove the screw from the right panel.

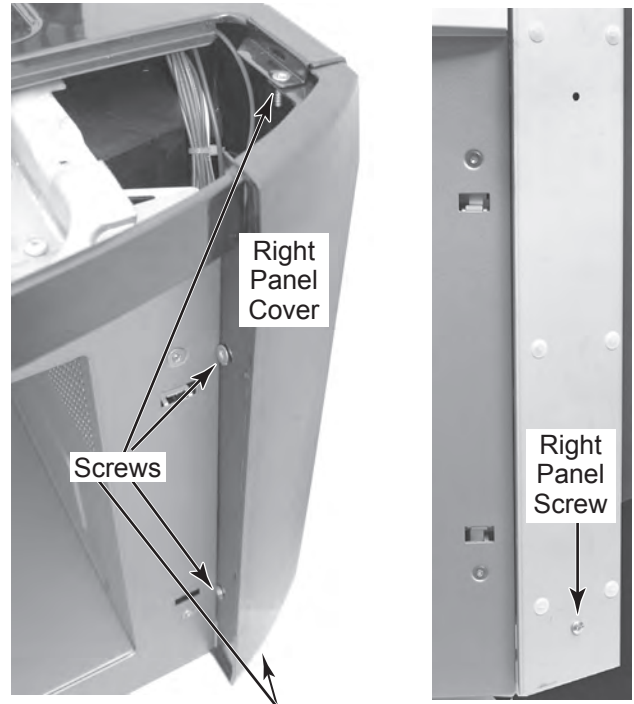

**Continued on the next page.**

6. **To remove the relay control board:**

- a) Lift the right panel and relay control board and unhook the two side T-tabs, and pull the right panel and relay control board forward as far as the wires will allow.
- b) Disconnect all of the wire connectors from the relay control board plugs.
- c) Squeeze the locking tabs on top of the six standoffs, and pull the relay control board off the standoffs.

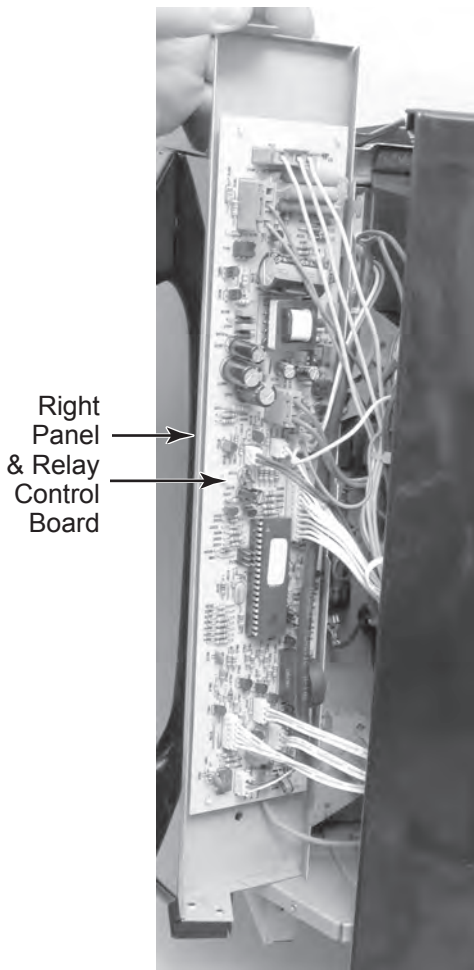

- d) Remove the T10 torx screw from the green ground wire and remove the relay control board. **NOTE:** The relay control board and its connectors and wire colors are shown on the following page.

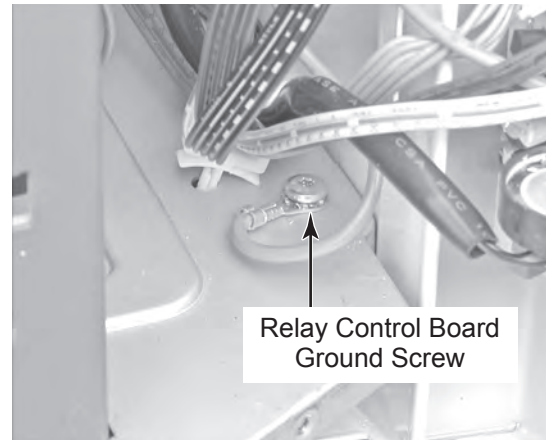

7. **To remove the line fuse:**

- a) Unhook the two side tabs, and pull the right panel and relay control board forward as far as the wires will allow.
- b) Remove the line fuse from the fuse holder.

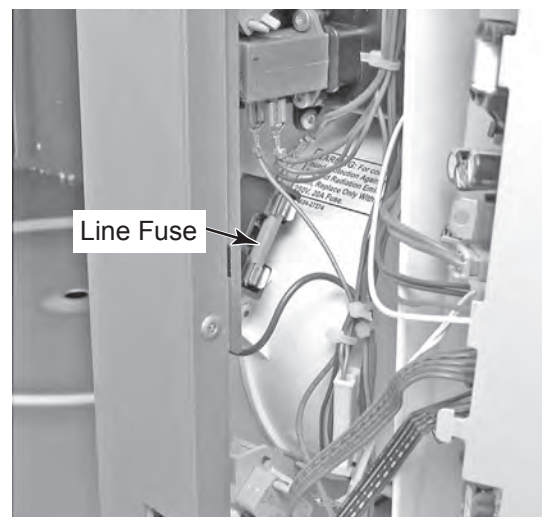



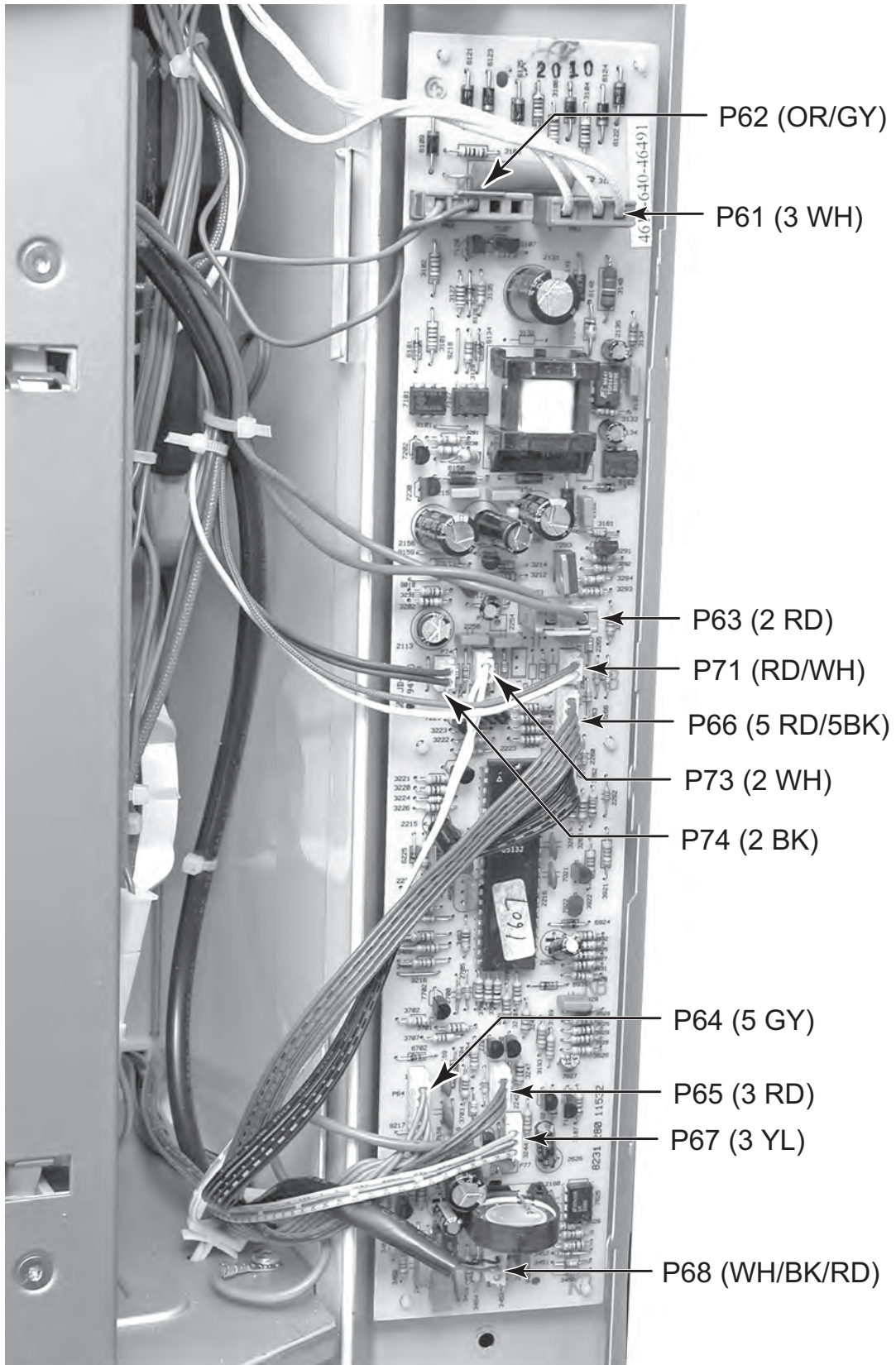

Relay Control Board W/Connectors & Wire Color Callouts

## REMOVING THE OVEN DOOR COMPONENTS

### **⚠ WARNING**



#### **Electrical Shock Hazard**

**Disconnect power before servicing.**

**Replace all parts and panels before operating.**

**Failure to do so can result in death or electrical shock.**

1. Unplug microwave oven or disconnect power.
2. Lower the bottom cover (see page 4-2 for the procedure).
3. **To remove the oven door:**
  - a) From the bottom of the oven, press the locking arm on the user interface board (UIB) connector to disengage it, and disconnect the connector from the chassis plug.



- b) Open the microwave oven door.
- c) Remove the screw at the top of the oven door hinge.
- d) Close the oven door but do not latch it. Lift the door, unhook the bottom hinge pin from the bracket, and remove the door.



- e) Lay the oven door face down on a padded surface to protect it.
- f) Pull out and unclip the door wire channel from the chassis cutout.



g) Pull the wires and the UIB connector out through the chassis cutout, and position the oven door with the top edge facing you.

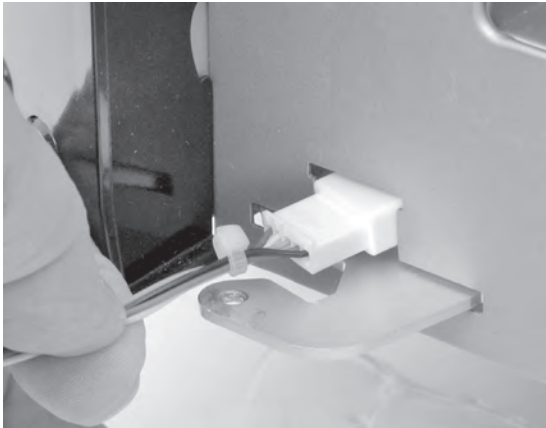

b) Using a putty knife, pry out on the outer door frame along the top to release the retainer clips. Then use a regular screwdriver and pry the side of the inner panel up, and lift the panel assembly out of the door frame.



**4. To remove the inner panel from the oven door:**

a) Remove the eight flat-head screws from the sides and bottom of the oven door trim.

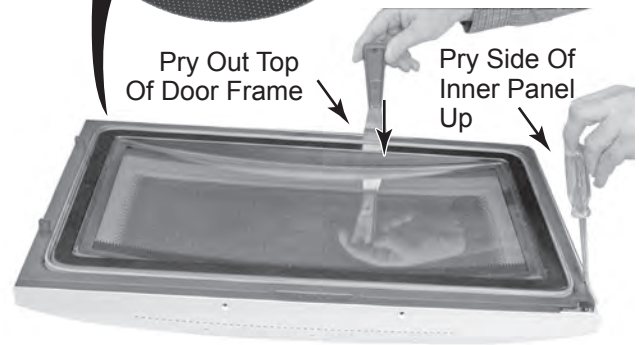

**Continued on the next page.**

- c) Remove the two T10 torx screws from the electronic control cover and remove the cover from the door.

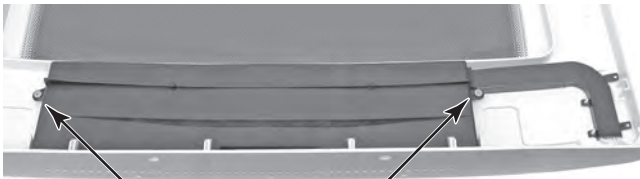

Electronic Control Cover Screws

- d) Disconnect the wire connectors between the user interface and the LCD display boards.

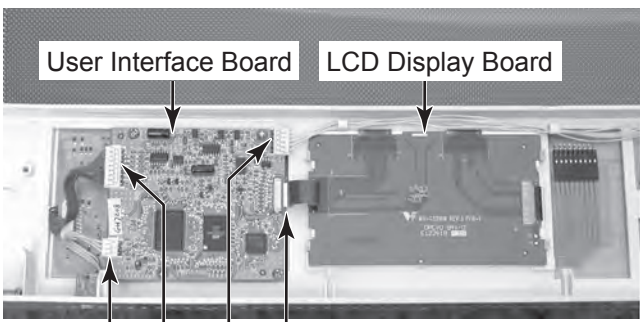

4 Board Connectors

- e) Remove the two screws from the user interface board and remove the board.

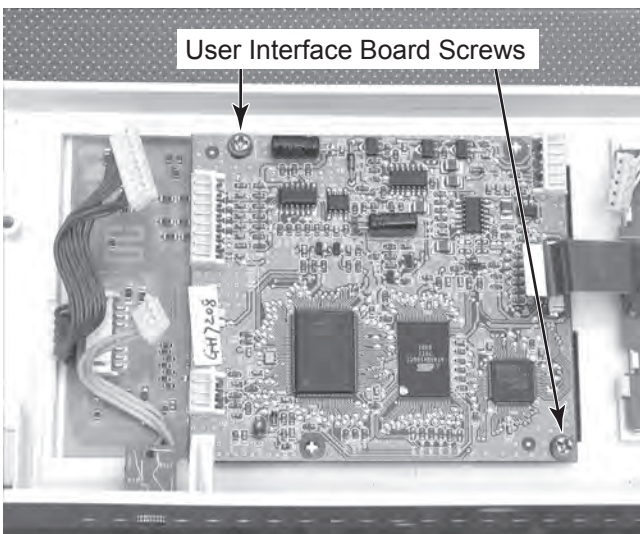

User Interface Board Screws

- f) Release the four clips from the LCD display board and remove it from the door frame.

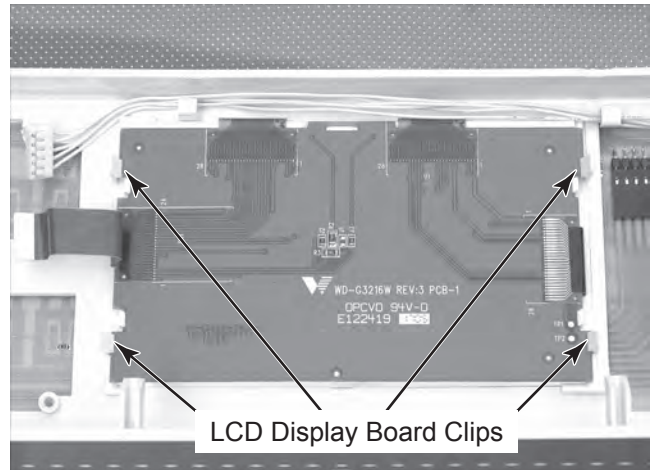

LCD Display Board Clips

- g) Remove the two T20 torx screws and washers from the door handle and remove the handle.

- h) Remove the three T20 torx screws from the top trim of the door and remove the trim.

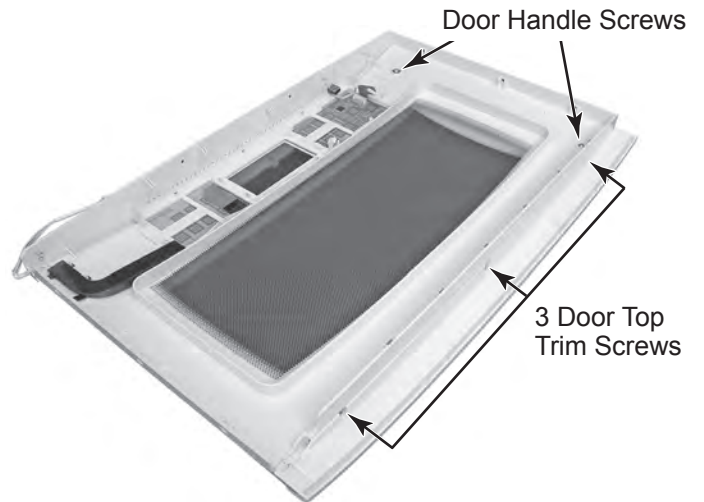

Door Handle Screws

3 Door Top Trim Screws

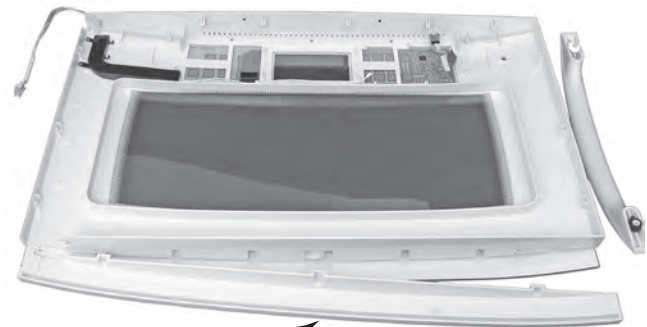

Remove Top Trim

- i) Lift the door glass assembly off the door frame.



Remove Door Glass



Door Glass Assembly

# REMOVING THE CAVITY LAMP AND THE HOOD/LIGHT SWITCH BOARD

## ⚠ WARNING



### Electrical Shock Hazard

Disconnect power before servicing.  
Replace all parts and panels before operating.

Failure to do so can result in death or electrical shock.

1. Unplug microwave oven or disconnect power.
2. Lift the two tabs and remove the center air flow screen from the top of the cabinet.



3. **To remove the cavity lamp socket:**
  - a) Remove the T10 torx screw from the cavity lamp cover.

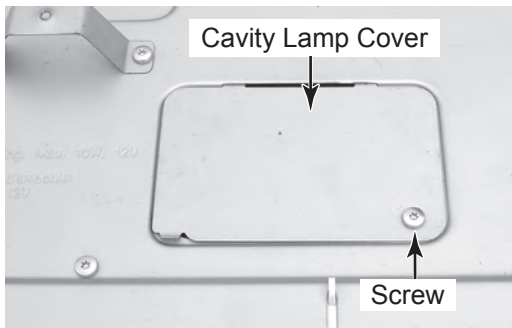

- b) Remove the clip from the cavity lamp socket and remove the lamp and socket.

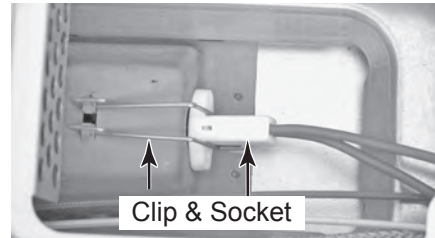

4. **To remove the hood/light switch board:**
  - a) Lower the bottom cover (see page 4-2 for the procedure).
  - b) From the bottom of the oven, remove the two screws and flat washers from the hood/light switch board.

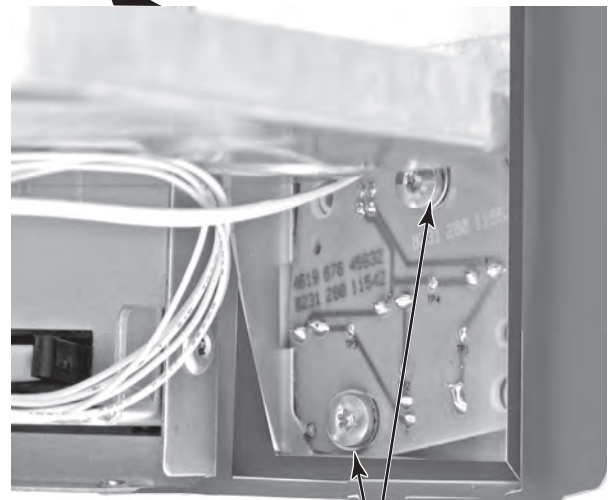

- c) Disconnect the hood/light switch board connector from the chassis and remove the board.

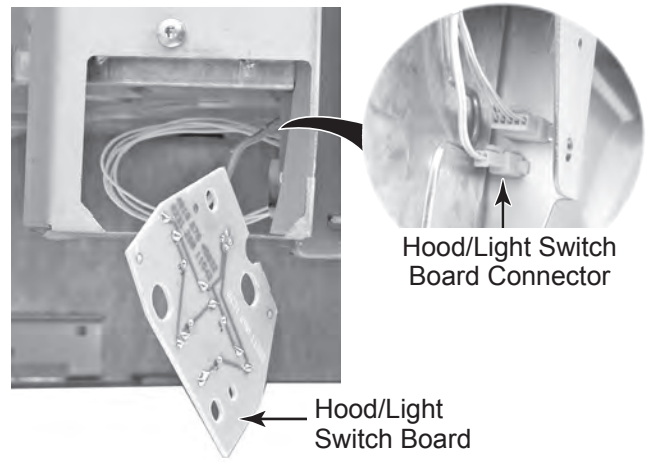

# REMOVING THE PRIMARY, SECONDARY, AND MONITOR INTERLOCK SWITCHES

## ⚠ WARNING



### Electrical Shock Hazard

Disconnect power before servicing.

Replace all parts and panels before operating.

Failure to do so can result in death or electrical shock.

1. Unplug microwave oven or disconnect power.
2. Open the microwave oven door.
3. Remove the relay control board and its panel from the unit (see pages 4-7 and 4-8 for the procedure).
4. Remove the T10 torx screw for the switch(es) you are servicing.

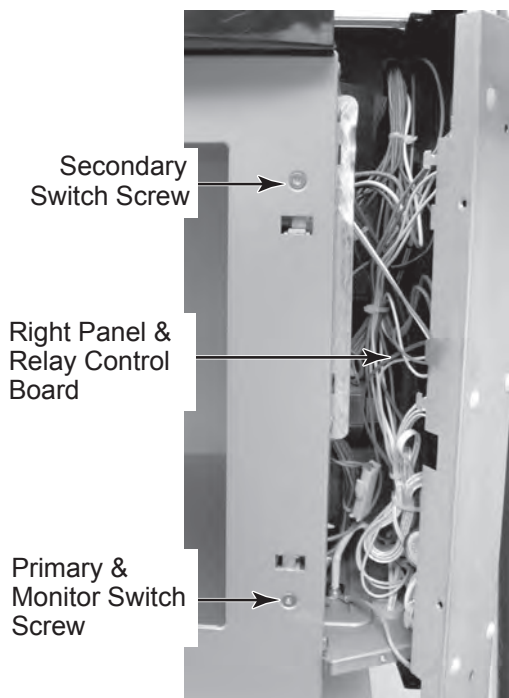

5. Insert a small screwdriver blade into each of the switch actuator slots, and rotate the switch actuators to unlock them, then remove the switch assemblies from the oven.

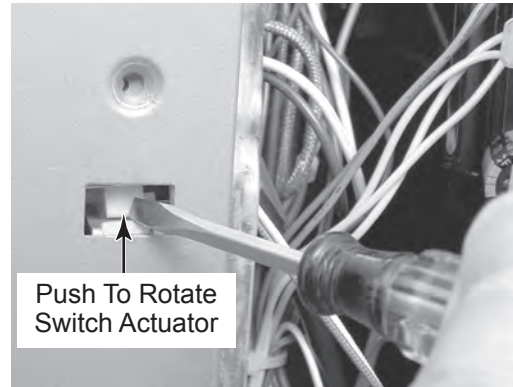

6. Disconnect the wires from the switch terminals.
7. Carefully bend the two locking tabs so they disengage from the switch, and pull the switch off the holder pins.

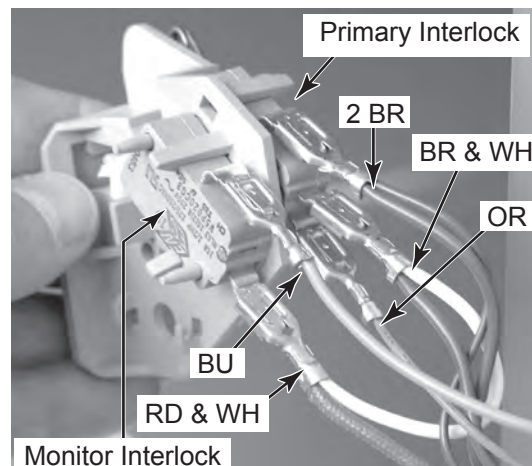
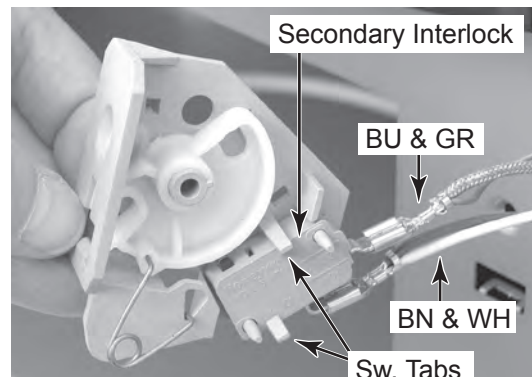



## REMOVING THE OVEN FROM THE INSTALLATION

### **⚠ WARNING**



#### **Electrical Shock Hazard**

**Disconnect power before servicing.**

**Replace all parts and panels before operating.**

**Failure to do so can result in death or electrical shock.**

1. Unplug microwave oven or disconnect power.
2. Open the cabinet doors over the microwave oven.

### **⚠ WARNING**

#### **Excessive Weight Hazard**

**Use two or more people to move or install microwave oven.**

**Failure to do so can result in back or other injury.**

3. While supporting the bottom of the microwave oven, locate and remove the two mounting bolts from the top of the microwave oven. **NOTE:** The unit will rotate down when these two bolts are removed.
4. Using two or more people, carefully rotate the front of the oven down, and unhook the back from the wall mounting plate.

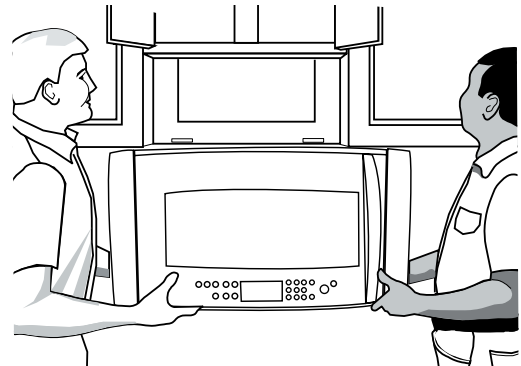

## REMOVING THE CABINET

### **⚠ WARNING**



#### **Electrical Shock Hazard**

**Disconnect power before servicing.**

**Replace all parts and panels before operating.**

**Failure to do so can result in death or electrical shock.**

1. Unplug microwave oven or disconnect power.
2. Remove the microwave oven from its mounting location (see page 4-17 for the procedure).
3. Lift the two tabs and remove the center air flow screen from the top of the cabinet.

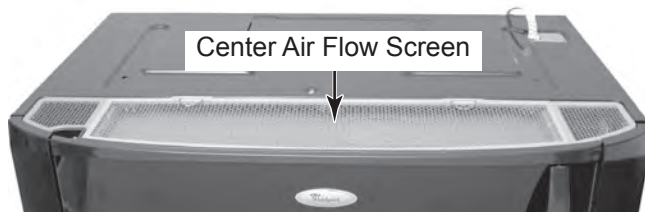

4. Remove the T10 torx screws from the left and right air flow screens and remove the screens from the top of the cabinet.



5. Remove the three T10 torx screws from the top of the cabinet.
6. Remove the T10 torx screw from the power cord cover and remove the cover.

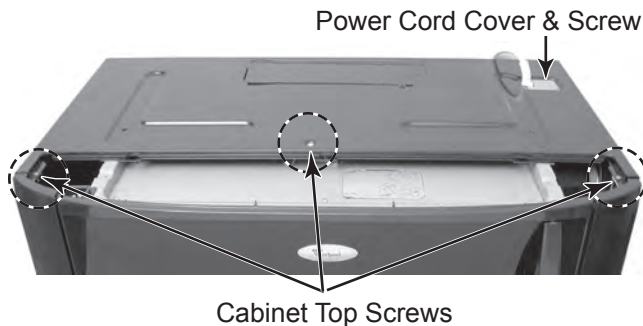

7. Remove the two T10 torx screws from the left and right sides of the cabinet, and the eight screws from the rear cabinet flange.

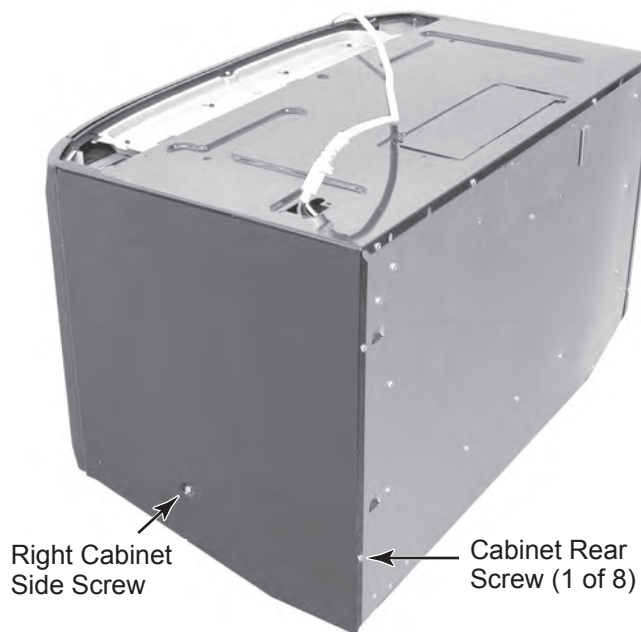

8. Pull the cabinet toward the rear of the unit, unhook the front top and side tabs from the slots, and remove the cabinet from the microwave oven.

# REMOVING THE FC (FORCED CONVECTION) THERMOSTAT, THE FC MOTOR, AND THE FC RING HEATER

## ⚠ WARNING



**Electrical Shock Hazard**  
Disconnect power before servicing.  
Replace all parts and panels before operating.  
Failure to do so can result in death or electrical shock.

1. Unplug microwave oven or disconnect power.
2. Remove the microwave oven from its mounting location (see page 4-17 for the procedure).
3. Remove the cabinet from the microwave oven (see page 4-18 for the procedure).
4. **To remove the FC thermostat:**
  - a) Disconnect the two wires from the thermostat terminals.
  - b) Remove the two screws from the thermostat and remove it from the microwave oven.

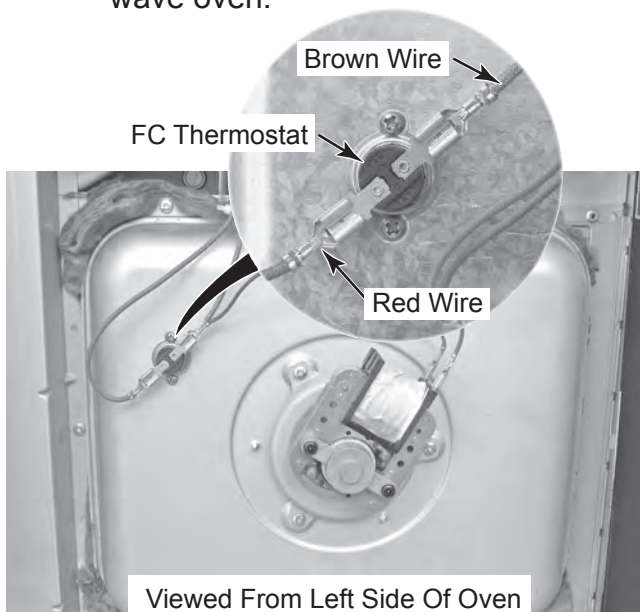

5. **To remove the FC motor:**
  - a) Disconnect the two wires from the FC motor terminals.
  - b) Remove the three T10 torx screws from the FC motor bracket, and remove the motor from the heater cover.

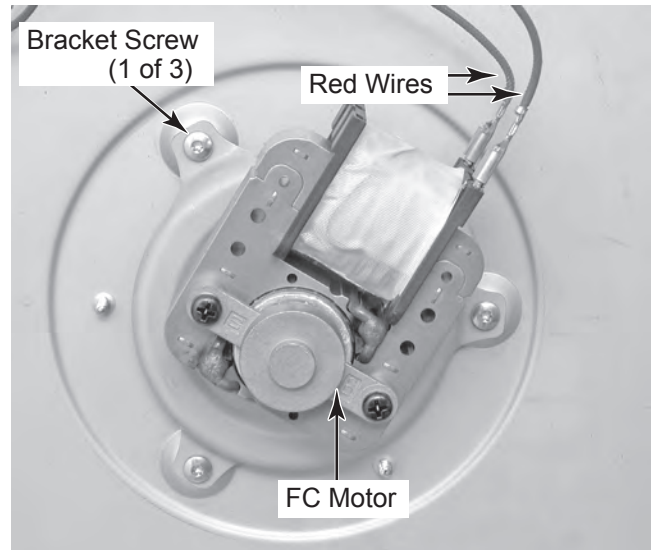

- c) Remove the four T10 torx screws from the heater cover, remove the cover, and turn it over.



**Continued on the next page.**

- d) Pry the clip off the FC motor shaft, and remove the fan blade and the flat washer below the blade from the shaft. Remove the FC fan motor.

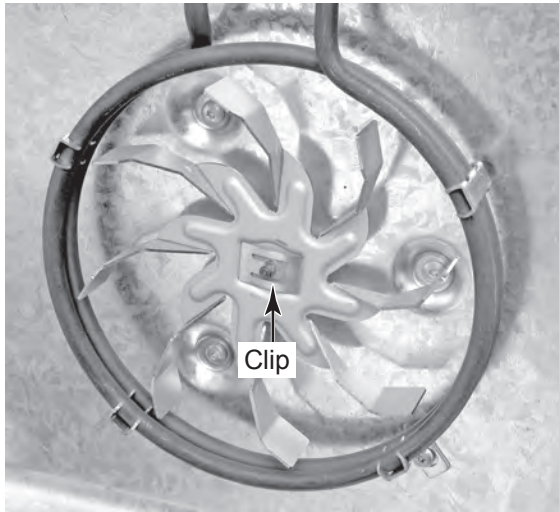

- e) Remove the two screws from the FC motor bracket and remove the bracket from the motor.

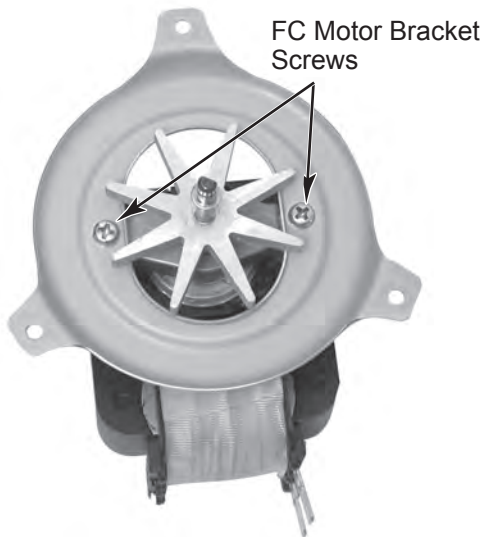

**6. To remove the FC ring heater:**

- a) Disconnect the two wires from the heater element terminals (see the top right photo).  
 b) Remove the four T10 torx screws from the heater cover, remove the cover, and turn it over.

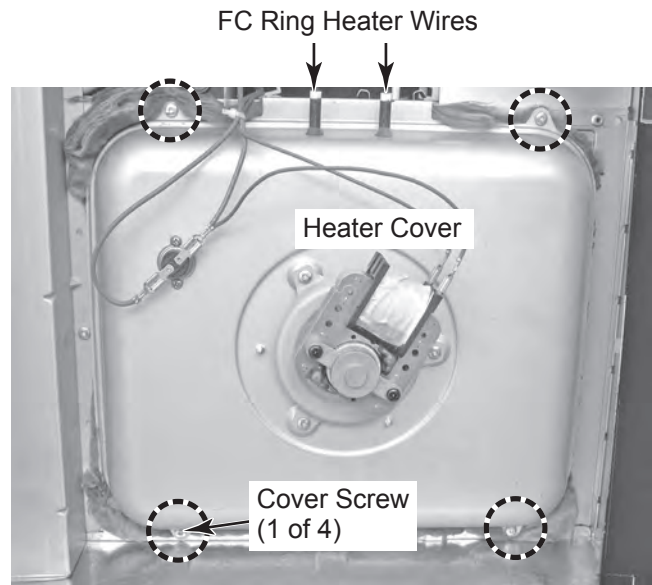

- c) Pry the clip off the FC motor shaft, and remove the fan blade and the flat washer below the blade from the shaft (see the top left photo).  
 d) Remove the T10 torx screw from the FC ring heater bracket, and the three T10 torx screws from the inner heater cover, then pull the inner cover off the oven.

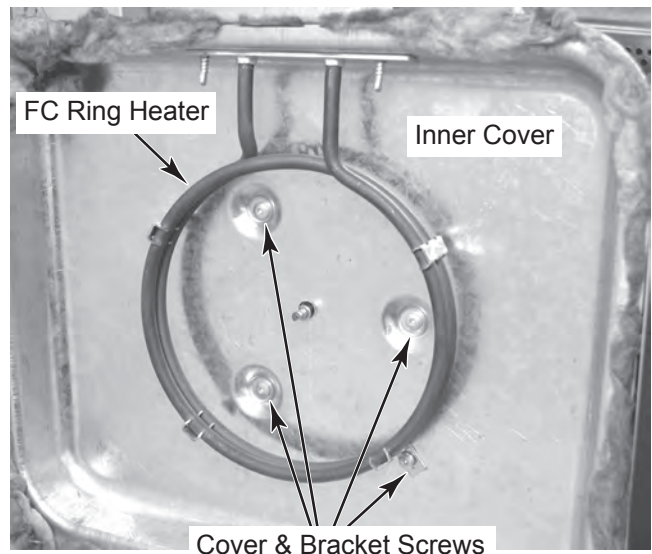

- e) Remove the two 5/16" hex-head screws from the FC ring heater bracket on the inner cover, and remove the element.

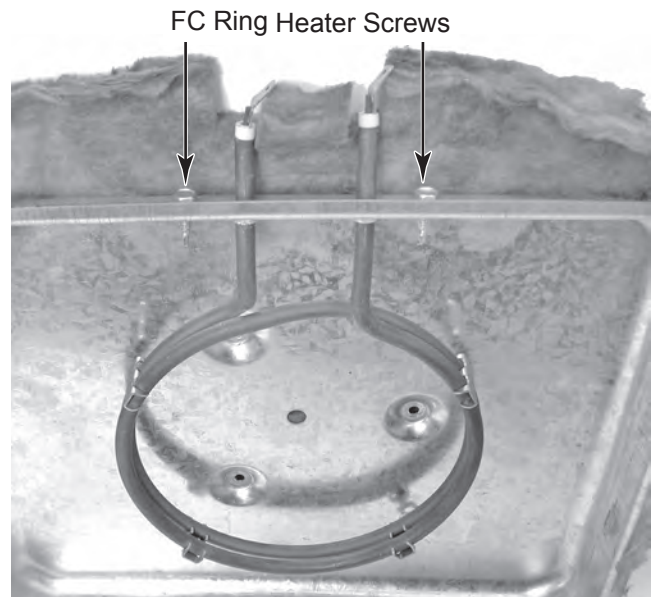

# REMOVING THE FC THERMISTOR, AND THE CAVITY THERMOSTAT & HUMIDITY SENSOR

## ⚠ WARNING



### Electrical Shock Hazard

**Disconnect power before servicing.**  
**Replace all parts and panels before operating.**  
**Failure to do so can result in death or electrical shock.**

1. Unplug microwave oven or disconnect power.
2. Remove the microwave oven from its mounting location (see page 4-17 for the procedure).
3. Remove the cabinet from the microwave oven (see page 4-18 for the procedure).
4. Peel back the foil from the rear of the top cover.
5. Remove the six indicated T10 torx screws from the top cover.
6. Lift the top cover by the bracket and remove the cover from the microwave oven.

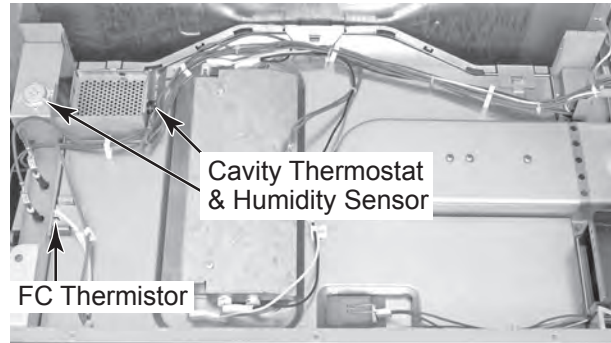
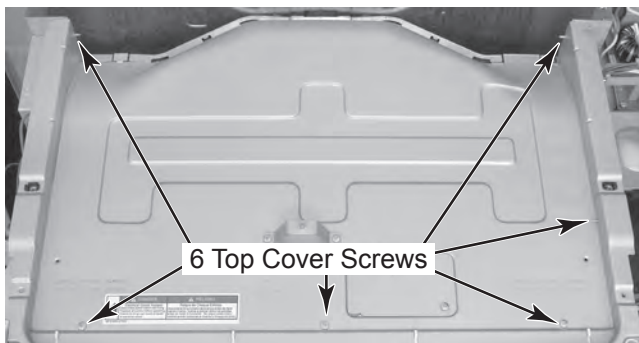

### 7. To remove the FC thermistor:

- a) Squeeze the ends of the clip and remove the clip and the FC thermistor.
- b) Remove the FC thermistor wires from the standoffs at the top of the chassis.

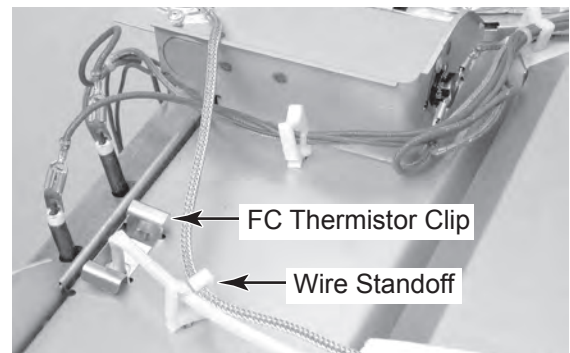

- c) Disconnect the FC thermistor connector at relay control board plug P71, and remove the thermistor.

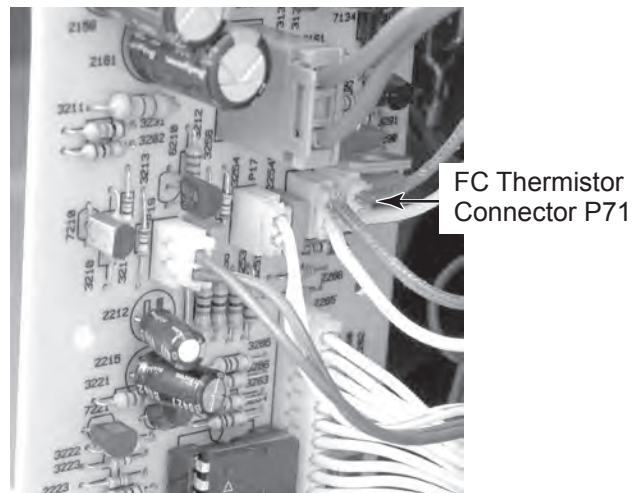

8. **To remove the cavity thermostat and humidity sensor:**

**NOTE:** The cavity thermostat and humidity sensor are serviced as an assembly.

- a) Lift and unhook the clip at the rear of the mounting bracket for the cavity thermostat and humidity sensor.

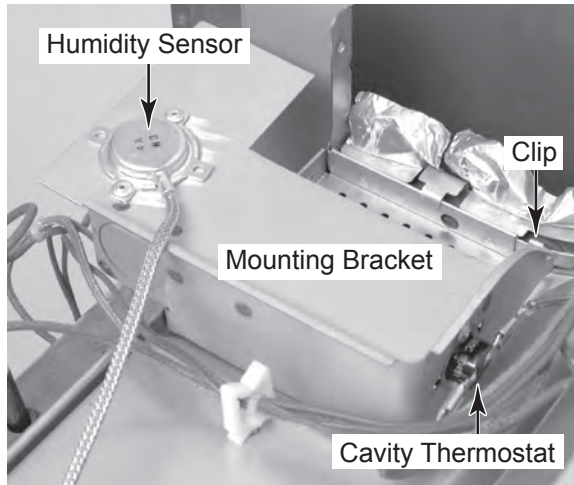

- b) Disconnect the wires from the cavity thermostat terminals.
- c) Remove the sensor wires from the standoffs at the top of the chassis.

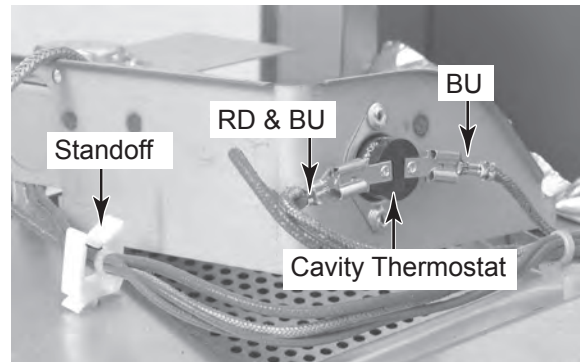

- d) Disconnect the humidity sensor connector at relay control board plug P68, and remove the bracket with the cavity thermostat and humidity sensor.

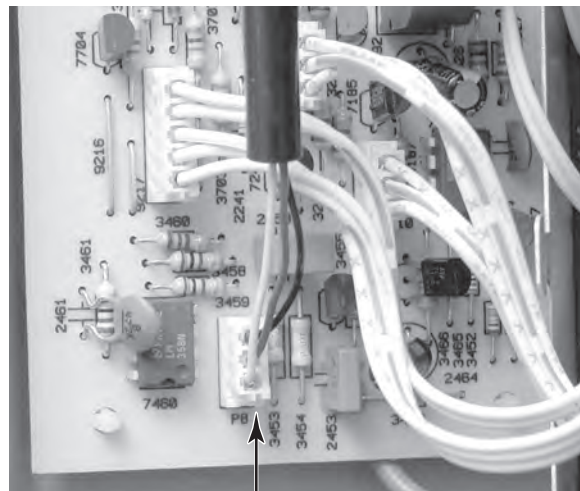

Humidity Sensor Connector P68

## REMOVING THE GRILL THERMOSTAT AND GRILL ELEMENTS

### **⚠ WARNING**



**Electrical Shock Hazard**  
**Disconnect power before servicing.**  
**Replace all parts and panels before operating.**  
**Failure to do so can result in death or electrical shock.**

1. Unplug microwave oven or disconnect power.
2. Remove the microwave oven from its mounting location (see page 4-17 for the procedure).
3. Remove the cabinet from the microwave oven (see page 4-18 for the procedure).
4. Remove the top cover from the microwave oven ( see page 4-22 for the procedure).

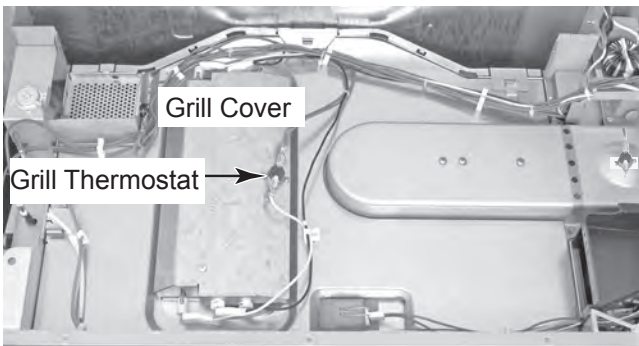

5. **To remove the grill thermostat:**
  - a) Remove the two wires from the thermostat terminals.

- b) Remove the two screws from the thermostat terminals, and remove the thermostat.

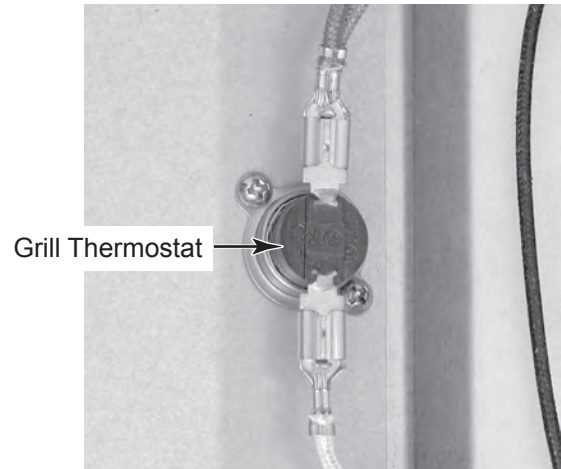

6. **To remove the grill elements:**

- a) Remove the two T10 torx screws from the grill element cover, lift the cover, and move it out of the way of the elements.

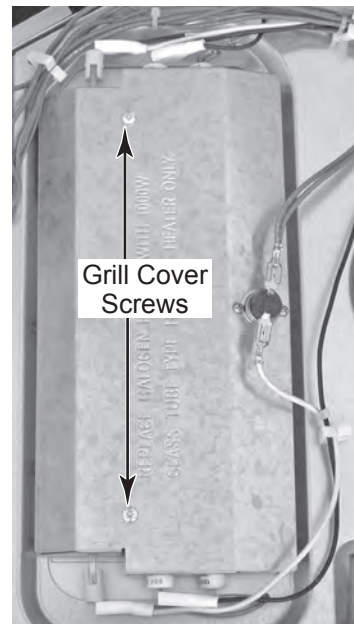



**NOTE:** Use a pair of clean cotton gloves to handle the grill elements, otherwise, the oil from your fingers could shorten their life.

- b) **Softstart Quartz Element Only:** Press down on the locking tabs, and pull the wire connectors off the ends of the quartz element, then remove the element from the unit. **NOTE:** The element glass is very fragile, so be careful when removing and installing connectors on the terminals.

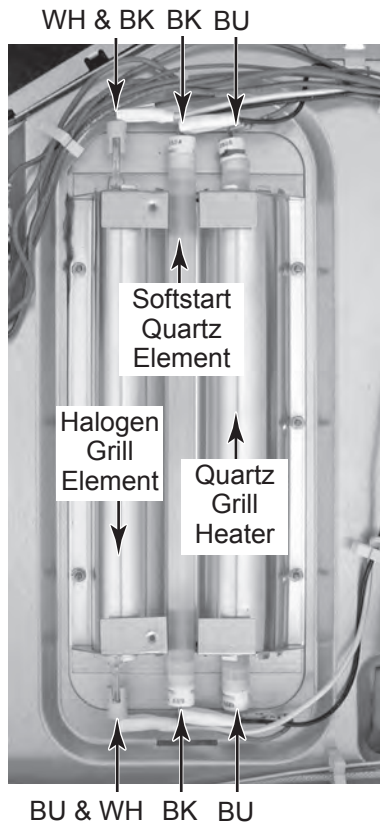

**NOTE:** Follow the remaining steps for removing the **Quartz Grill Heater & Halogen Grill Element**.

- c) Depending on which element you are removing, press down on the locking tabs, and pull the wire connectors off the ends of the quartz grill heater or the halogen grill element (see above photo). **NOTE:** The element glass is very fragile, so be careful when removing and installing connectors on the terminals.

- d) Remove the six 7/32" nuts and washers from the wire guard.



- e) Open the microwave oven door.  
f) Remove the wire guard from over the grill elements inside the oven cavity.

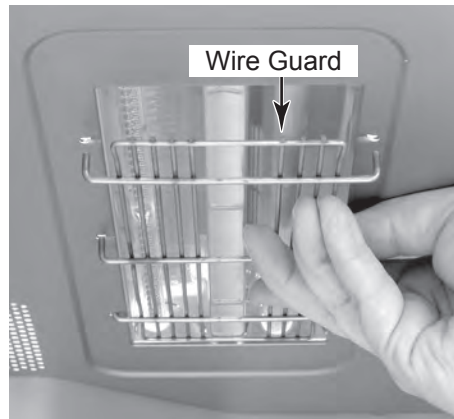

- g) Carefully remove the quartz grill heater or the halogen grill element from the oven cavity.

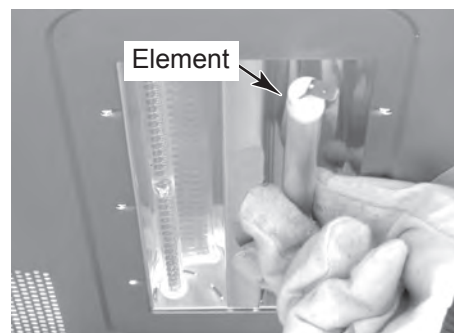

# REMOVING THE POWER SUPPLY CORD AND AC LINE FILTER

## ⚠ WARNING



### Electrical Shock Hazard

Disconnect power before servicing.

Replace all parts and panels before operating.

Failure to do so can result in death or electrical shock.

1. Unplug microwave oven or disconnect power.
2. Remove the microwave oven from its mounting location (see page 4-17 for the procedure).
3. Remove the cabinet from the microwave oven (see page 4-18 for the procedure).
4. Remove the top cover from the microwave oven ( see page 4-22 for the procedure).

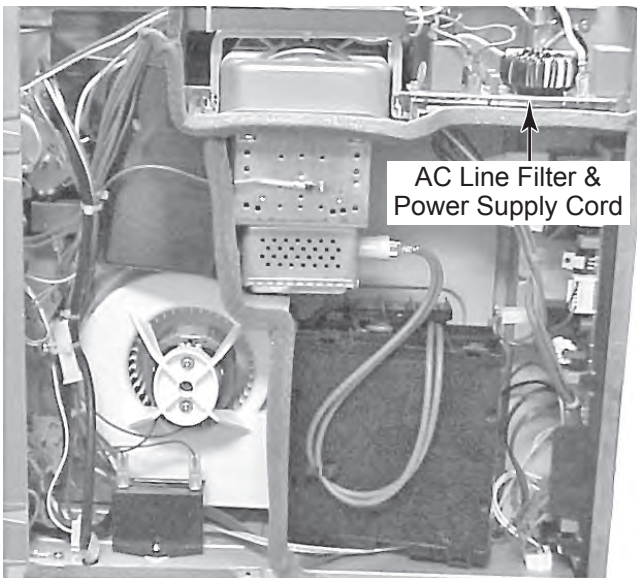

5. To remove the power supply cord:
  - a) Disconnect the white wire on the power supply cord from the AC line filter board at terminal P31, and the black wire at terminal P32.
  - b) Remove the chassis screw from the green ground wire on the power supply cord.

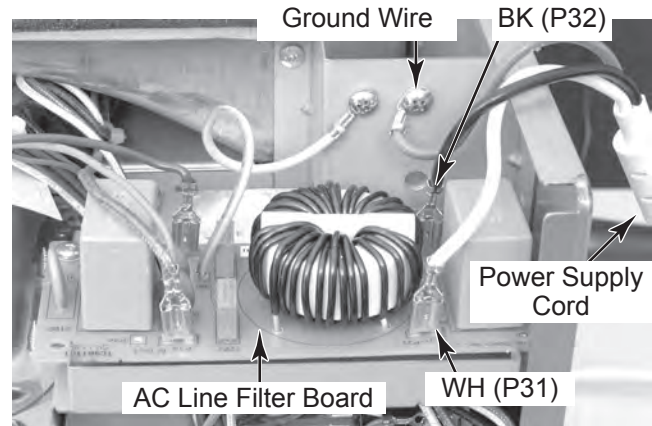

6. To remove the AC line filter:
  - a) Disconnect the white and black power supply cord wires from the AC line filter board (see above).
  - b) Disconnect the brown wire from the AC line filter board at terminal P33, and the two blue wires at terminal P34.
  - c) Remove the chassis screw from the yellow/green ground wire.
  - d) Remove the screw from the AC line filter board and remove the board from the microwave oven.

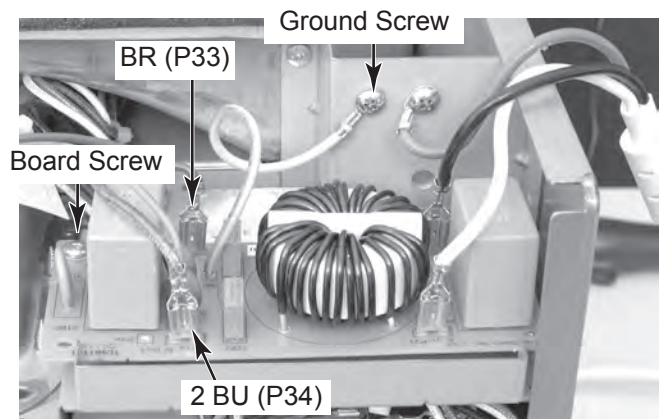

# REMOVING THE FC (FORCED CONVECTION) THERMOACTUATOR, THE MAGNETRON THERMISTOR, AND THE MAGNETRON

## ⚠ WARNING



### Electrical Shock Hazard

Disconnect power before servicing.

Replace all parts and panels before operating.

Failure to do so can result in death or electrical shock.

1. Unplug microwave oven or disconnect power.
2. Remove the microwave oven from its mounting location (see page 4-17 for the procedure).
3. Remove the cabinet from the microwave oven (see page 4-18 for the procedure).

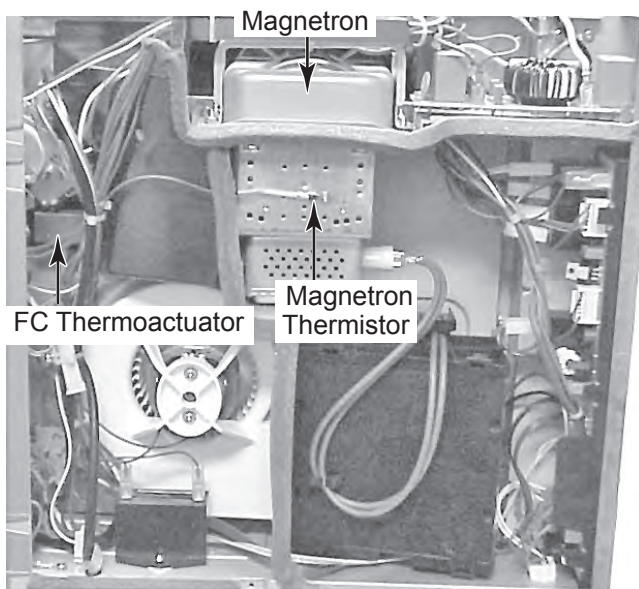

4. To remove the FC thermoactuator:
  - a) Remove the right cover and panel (see page 4-7 for the procedure).
  - b) Remove the top (secondary) door switch assembly (see page 4-16 for the procedure).
  - c) Press the locking tabs and disconnect the two wire connectors from the FC thermoactuator terminals.

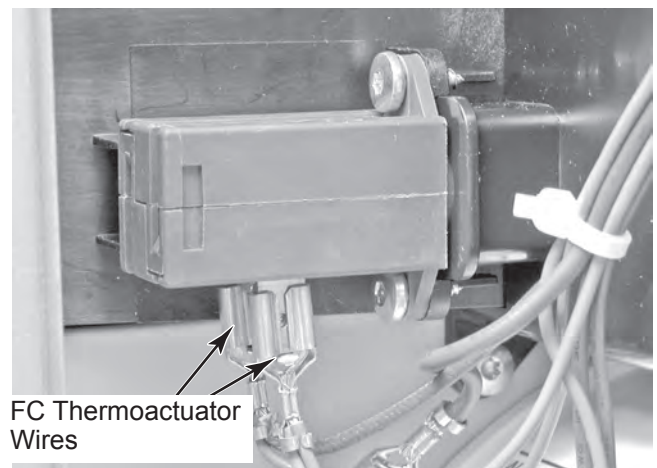

- d) Using a 90° T10 Allen wrench, remove the two FC thermoactuator screws, and remove the motor from the housing.

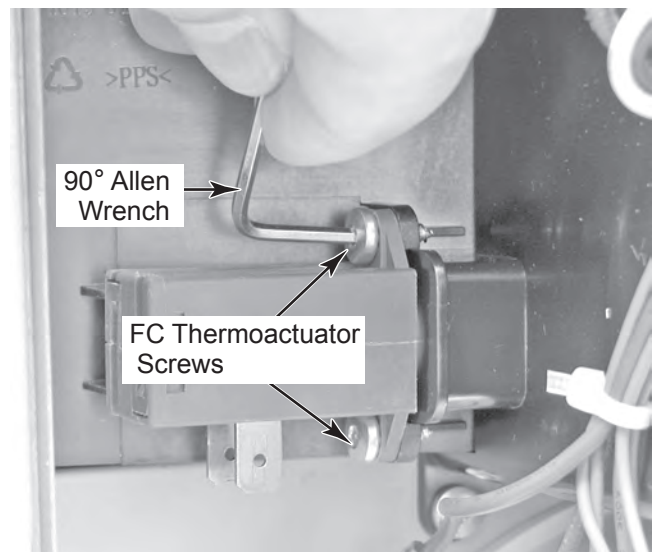

Continued on the next page.

5. **To remove the magnetron thermistor:**

- a) Remove the screw from the magnetron thermistor and remove the thermistor from the magnetron.
- b) Cut the wire tie and remove the magnetron thermistor wires from the wire bundle.
- c) Disconnect the magnetron thermistor connector from relay control board connector P74.

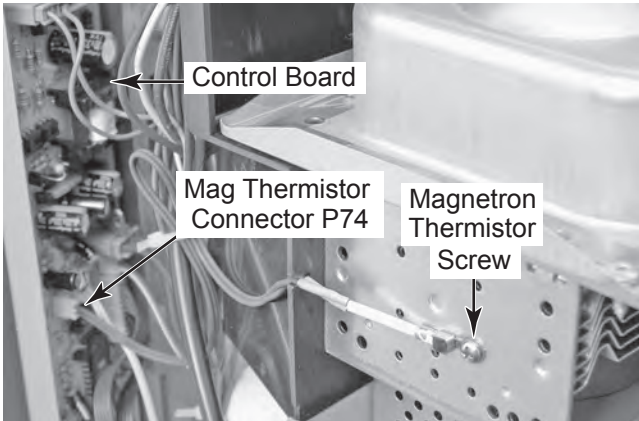

6. **To remove the magnetron:**

- a) Remove the magnetron thermistor from the magnetron (see step 5a).
- b) Remove the screw from the wire channel.
- c) Remove the wires from the AC line filter board (this will allow enough slack in the wires to remove them from the wire channel later).

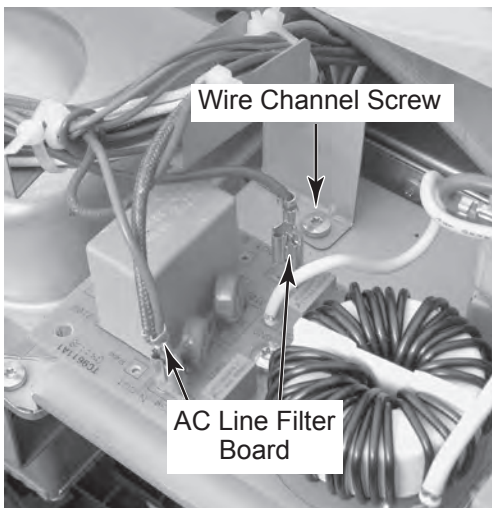

- d) Remove the three air duct screws, and remove the air duct from the chassis. **NOTE:** Remove the channel wires from the air duct as you remove the duct from the unit.

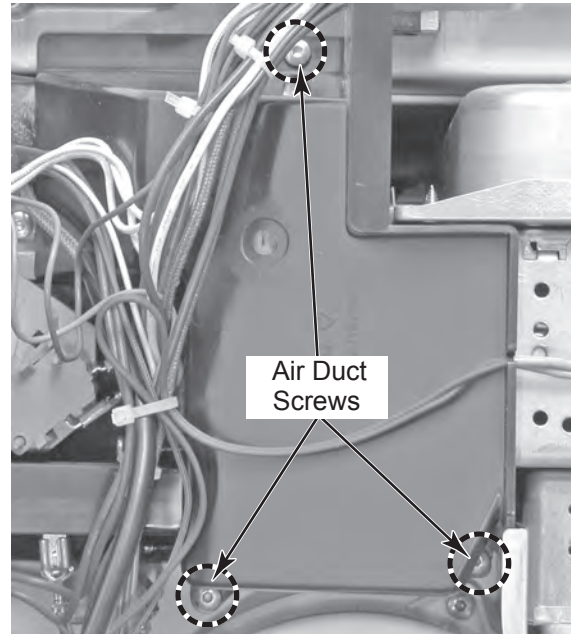

- e) **CAUTION:** Discharge the inverter board (see step 4 on page 4-31 for the procedure).
- f) Disconnect the two filament wires from the magnetron terminals.
- g) Remove the four T20 torx screws from the magnetron, and remove the magnetron from the microwave oven.

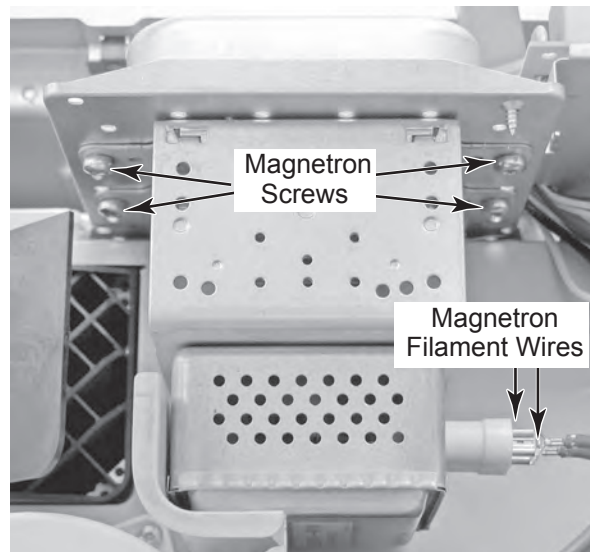

# REMOVING THE WAVEGUIDE THERMOSTAT & EXHAUST FAN MOTOR CAPACITOR

## ⚠ WARNING



**Electrical Shock Hazard**  
Disconnect power before servicing.  
Replace all parts and panels before operating.  
Failure to do so can result in death or electrical shock.

1. Unplug microwave oven or disconnect power.
2. Remove the microwave oven from its mounting location (see page 4-17 for the procedure).
3. Remove the cabinet from the microwave oven (see page 4-18 for the procedure).

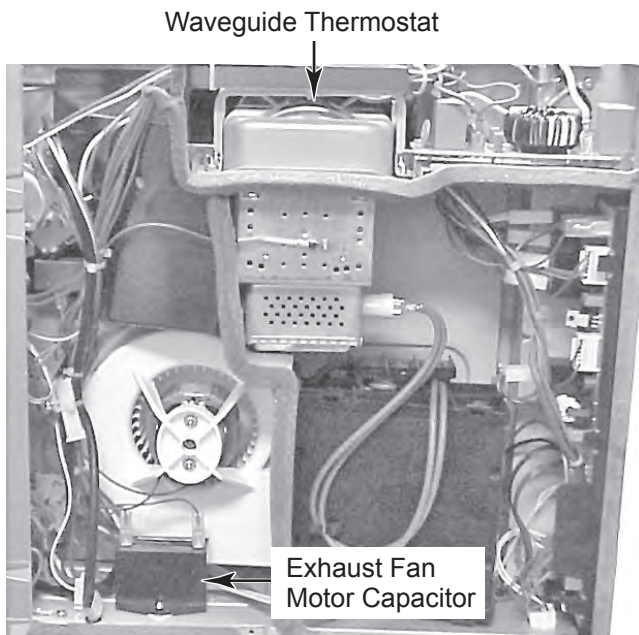

4. To remove the waveguide thermostat:
  - a) Disconnect the two wire connectors from the waveguide thermostat terminals.
  - b) Remove the two hex nuts from the waveguide thermostat bracket and remove the thermostat.

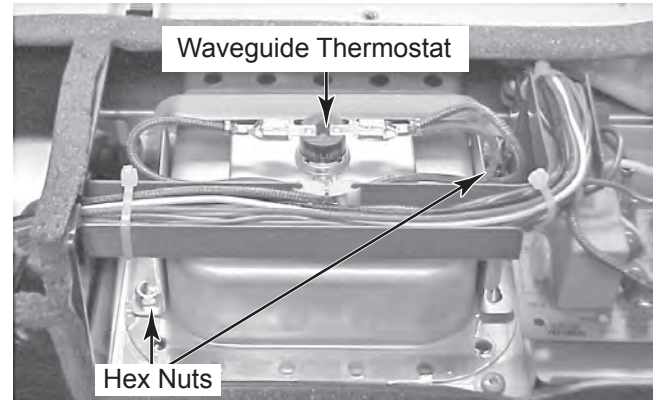

5. To remove the exhaust fan motor capacitor:
  - a) Disconnect the two wire connectors from the capacitor terminals.
  - b) Remove the screw from the base of the capacitor and remove the capacitor.

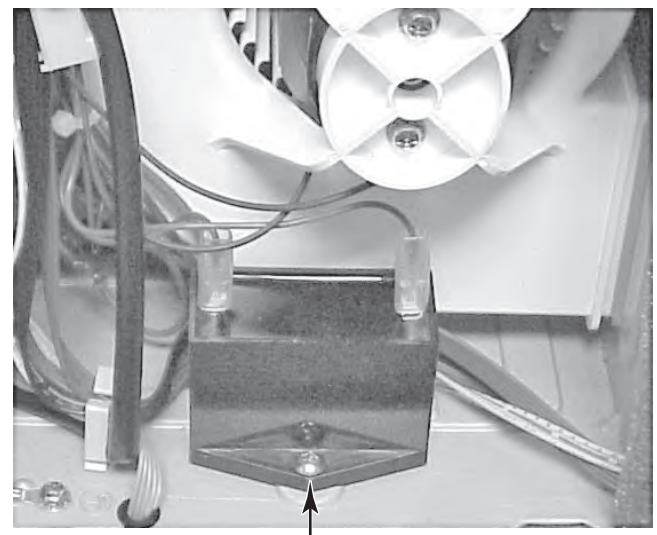

## REMOVING THE COOLING FAN MOTOR

### **⚠ WARNING**



#### **Electrical Shock Hazard**

**Disconnect power before servicing.**

**Replace all parts and panels before operating.**

**Failure to do so can result in death or electrical shock.**

1. Unplug microwave oven or disconnect power.
2. Remove the microwave oven from its mounting location (see page 4-17 for the procedure).
3. Remove the cabinet from the microwave oven (see page 4-18 for the procedure).

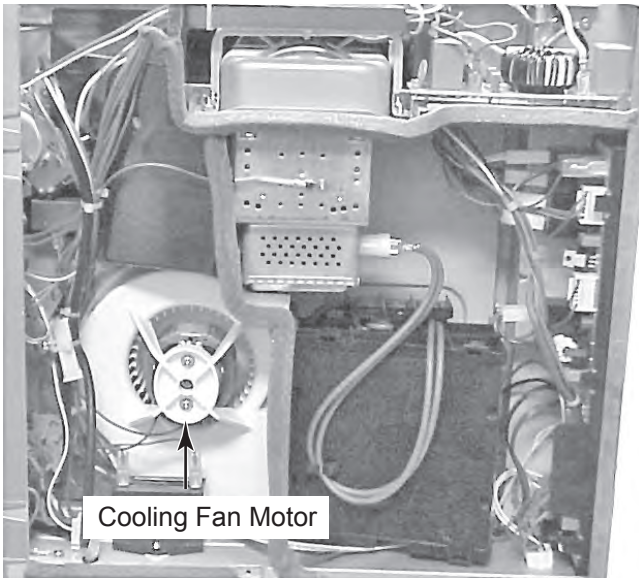

4. Disconnect the cooling fan motor connector from the main harness (see the top right photo).
5. Remove the three T10 torx screws from the cooling fan motor housing and remove the housing from the chassis.

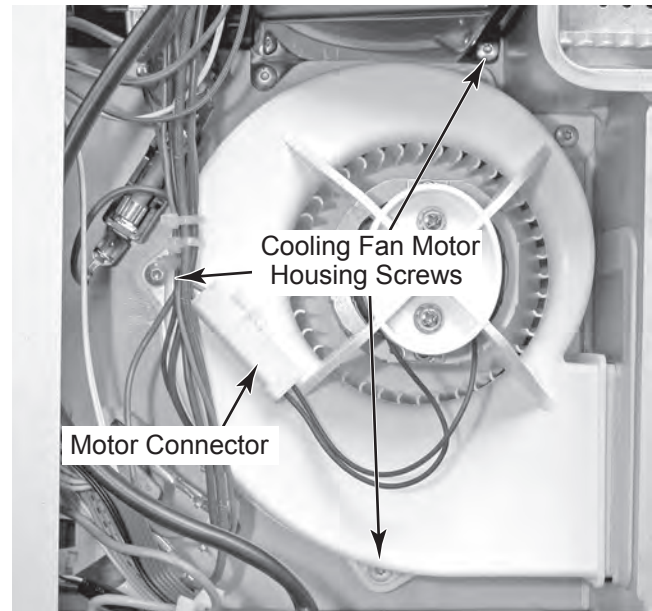

6. Remove the two screws and washers from the cooling fan motor and remove it from the housing.

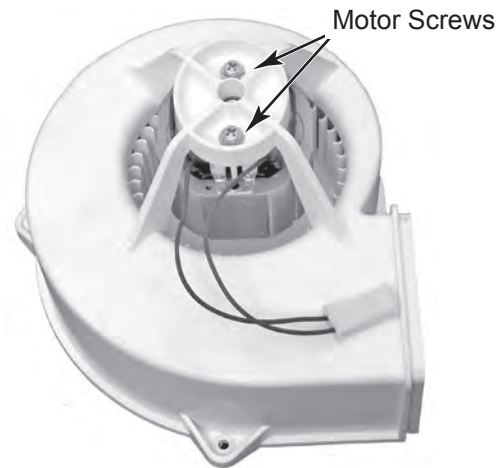

7. Pull the fan off the motor shaft.

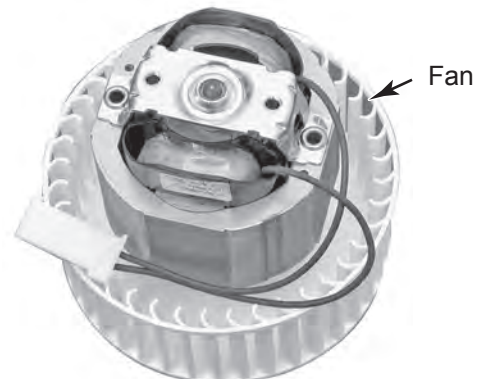

## REMOVING THE INVERTER BOARD

### **⚠ WARNING**



**Electrical Shock Hazard**  
**Disconnect power before servicing.**  
**Replace all parts and panels before operating.**  
**Failure to do so can result in death or electrical shock.**

1. Unplug microwave oven or disconnect power.
2. Remove the microwave oven from its mounting location (see page 4-17 for the procedure).
3. Remove the cabinet from the microwave oven (see page 4-18 for the procedure).

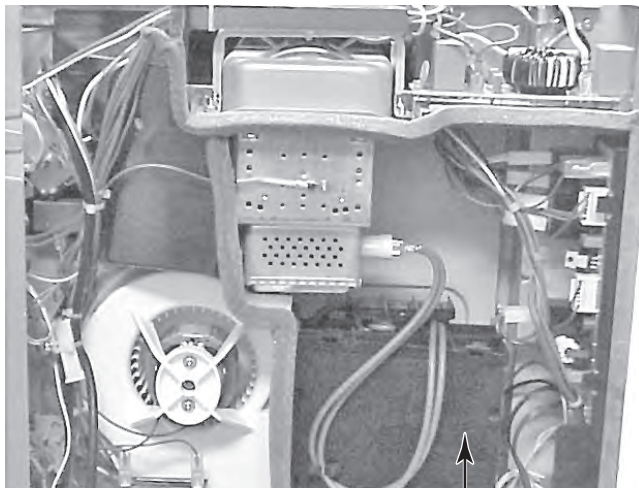

Inverter Board Housing

4. **CAUTION:** Discharge the inverter board. Using a plastic handle (insulated) screwdriver, touch the metal tip of the screwdriver to the chassis, (see the photo at the top right column), and the shaft against either of the two magnetron filament terminals for approximately 5 seconds to discharge the inverter board.

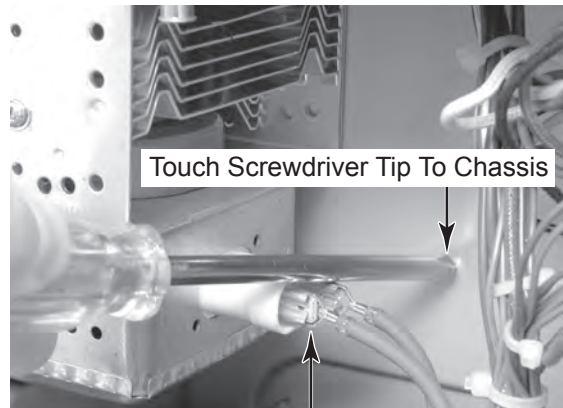

Touch Screwdriver Tip To Chassis

Touch Screwdriver Shaft To Filament Terminals

5. Disconnect the two magnetron filament wires from the magnetron terminals.
6. Remove the T10 torx screw from the bottom of the inverter board housing.
7. Slide the bottom of the inverter board housing assembly out and unhook the top left and right chassis tabs (see the photo below) from the slots in the housing. Pull the housing out of the unit as far as the wires will allow, and rotate the housing upside down on a work surface.

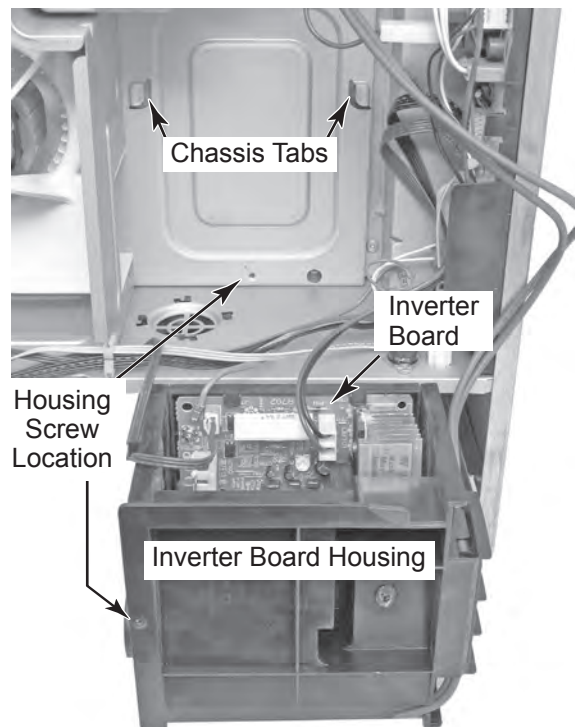

Chassis Tabs

Inverter Board

Housing Screw Location

Inverter Board Housing

8. Disconnect the black and blue wires (CN702) and the 3-wire connector (CN701) from the inverter board.
9. Remove the screw from the green-yellow ground wire on the inverter board (E701).

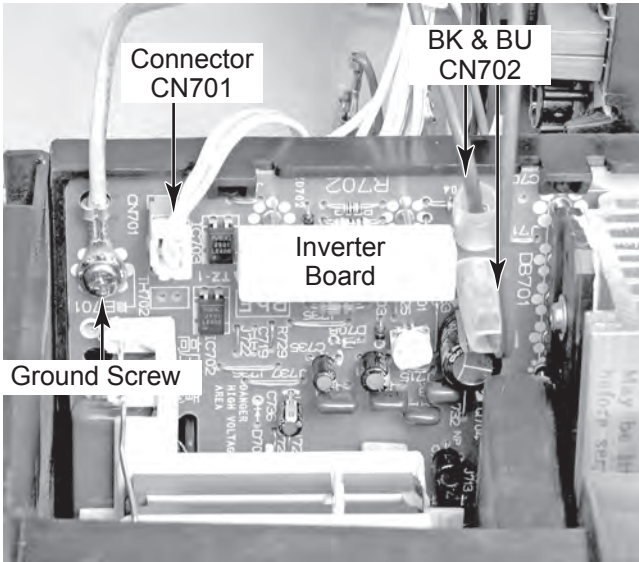

10. If installed, remove the filament wires from the standoff on the inverter board housing.
11. Unclip the mounting base from the housing, and lift the inverter board and base out of the housing. Rotate the inverter board so that it is facing up.

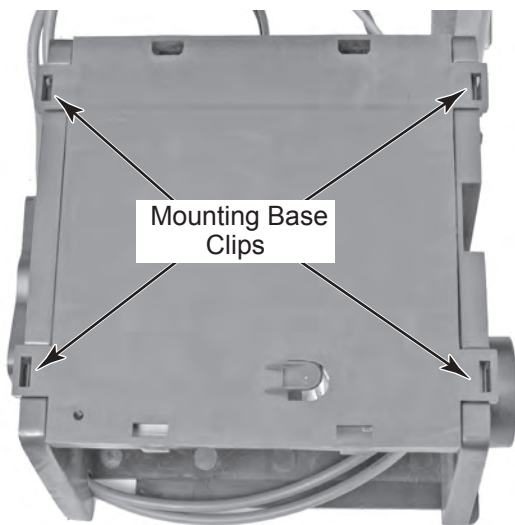

12. Disconnect the two filament wires from the inverter board at CN703.
13. Remove the T10 torx mounting screw from the inverter board and unclip it from the base.

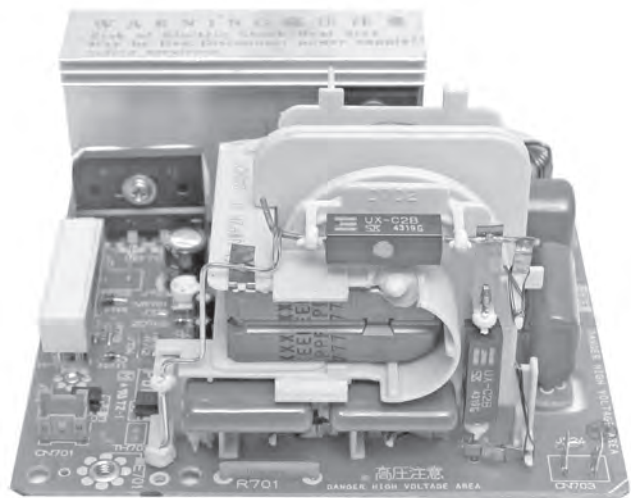
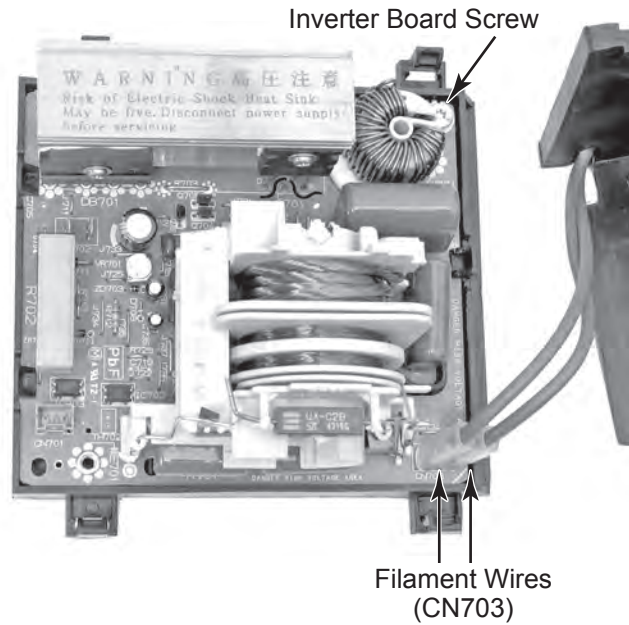

Inverter Board



## REMOVING THE RELAY BOARD

### **⚠ WARNING**



**Electrical Shock Hazard**  
**Disconnect power before servicing.**  
**Replace all parts and panels before operating.**  
**Failure to do so can result in death or electrical shock.**

1. Unplug microwave oven or disconnect power.
2. Remove the microwave oven from its mounting location (see page 4-17 for the procedure).
3. Remove the cabinet from the microwave oven (see page 4-18 for the procedure).

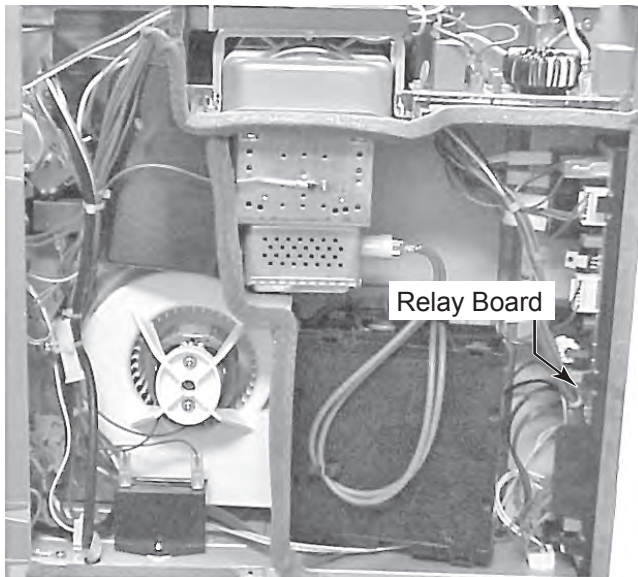

4. **CAUTION:** Discharge the inverter board (see step 4 on page 4-31 for the procedure).

5. Push out on the three outside tabs of the relay board holder, and lift the relay board out of the holder as far as the wires will allow.

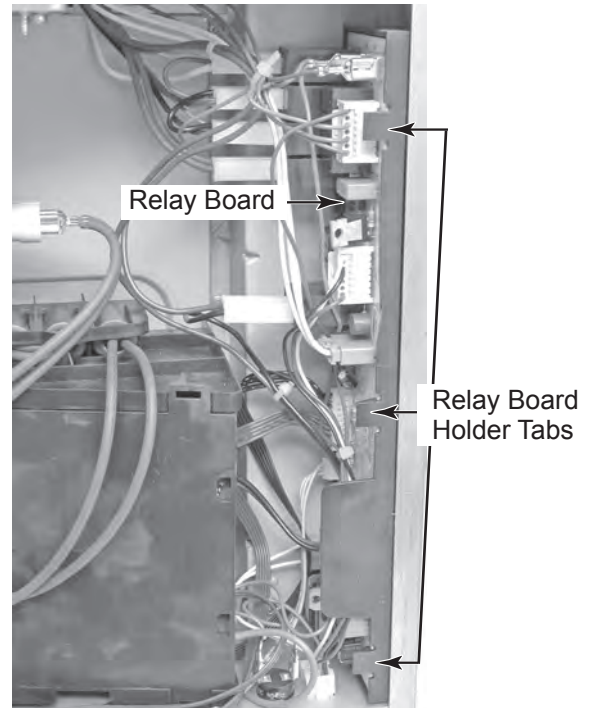

6. Disconnect the wire connectors from the relay board and remove the board from the microwave oven. **NOTE:** The connectors and their wire colors are shown on the following page.

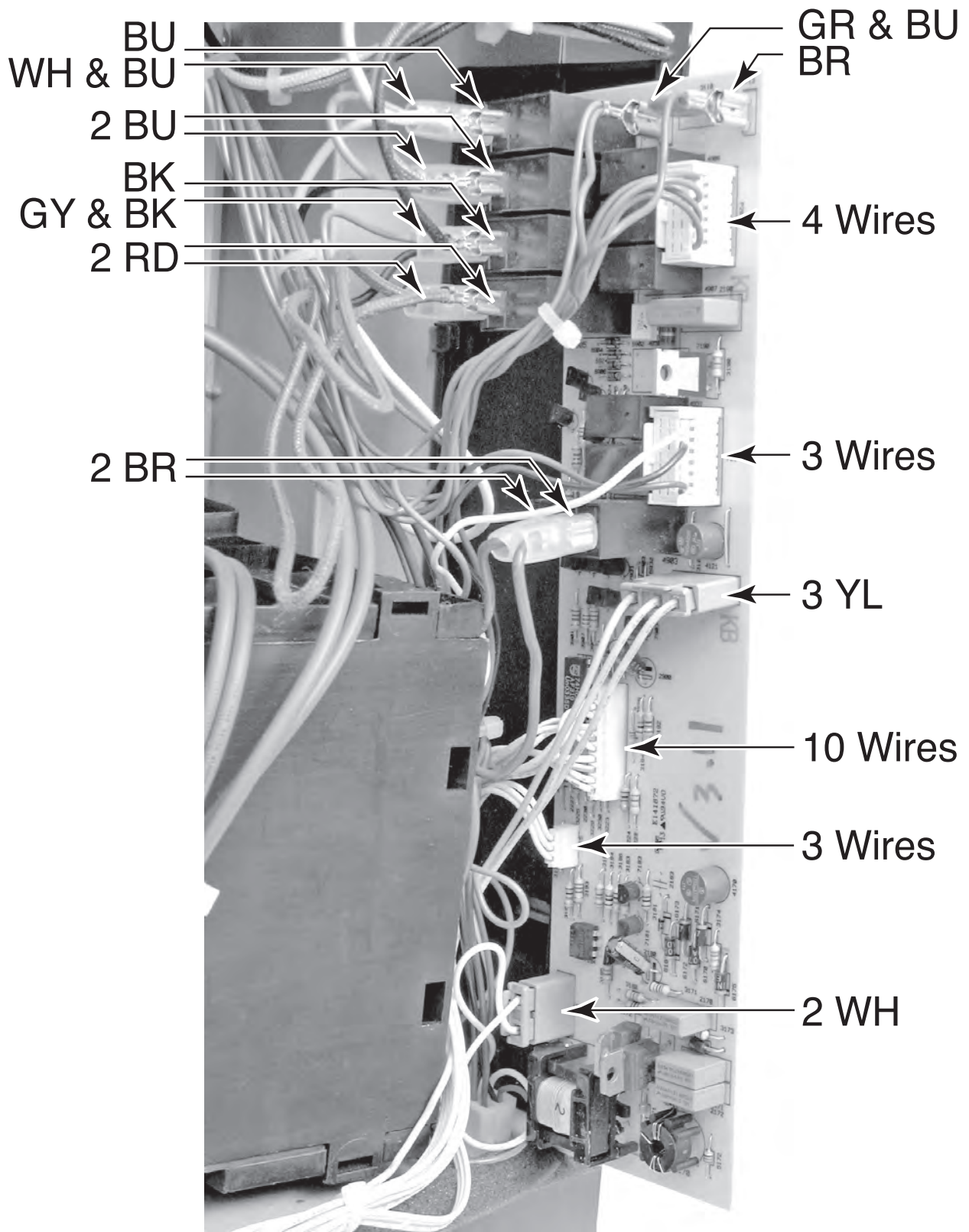

Relay Board W/Connector Wire Color Callouts

# COMPONENT TESTING

**IMPORTANT:** Before performing any tests on the microwave oven, be sure to observe the following:

- Unplug microwave oven or disconnect power.
- Remove the lead wires from the related component before conducting any of the following tests.
- Discharge the inverter before conducting any of the following tests.
- All operational checks using microwave energy must be done with the microwave oven loaded with a minimum of 8 oz. (250 mL) of water in a microwave safe container.
- Conduct a microwave energy test after performing any tests or repairs to the microwave oven.
- Check that all wire leads are in the correct position before operating the microwave oven.
- Grasp wire connectors when removing the wire leads from microwave oven parts.
- All testing must be done with an ohmmeter having a sensitivity of 20,000 ohms-per-volt DC or greater, and powered by at least a 9-volt battery.



## ⚠ WARNING

### Electrical Shock Hazard

Disconnect power before servicing.

Replace all parts and panels before operating.

Failure to do so can result in death or electrical shock.

## BASE THERMOSTAT



Refer to page 4-3 for the procedure for accessing the base thermostat.

1. Unplug microwave oven or disconnect power.
2. Disconnect one of the wires from the base thermostat terminals.
3. Set the ohmmeter to the R x 1 scale.
4. Touch the ohmmeter test leads to the thermostat terminals. The meter should indicate an open (infinite) circuit.

## EXHAUST FAN MOTOR



Refer to page 4-3 for the procedure for accessing the exhaust fan motor.

1. Unplug microwave oven or disconnect power.
2. Disconnect the exhaust fan motor connector from the main harness connector.
3. Set the ohmmeter to the R x 1 scale.
4. Touch the ohmmeter test leads to the motor plug pins. The meter should indicate as follows:

Pin 1 (BK) to pin 2 (WH) =  $17 \pm 5 \Omega$ .

Pin 1 (BK) to pin 3 (RD) =  $21 \pm 5 \Omega$ .



## ⚠ WARNING

### Electrical Shock Hazard

Disconnect power before servicing.

Replace all parts and panels before operating.

Failure to do so can result in death or electrical shock.

### TURNTABLE MOTOR



Refer to page 4-5 for the procedure for accessing the turntable motor.

1. Unplug microwave oven or disconnect power.
2. Disconnect one of the wires from the turntable motor terminals.
3. Set the ohmmeter to the R x 10K scale.
4. Touch the ohmmeter test leads to the motor terminals. The meter should indicate  $2.2\text{ K} \pm 0.5\text{ K}\Omega$ .

### LINE FUSE



Refer to page 4-7 for the procedure for accessing the line fuse.

1. Unplug microwave oven or disconnect power.
2. Disconnect one of the wires from the fuse holder terminals.
3. Set the ohmmeter to the R x 1 scale.
4. Touch the ohmmeter test leads to the fuse holder terminals. The meter should indicate a closed ( $0\ \Omega$ ) circuit.



## ⚠ WARNING

### Electrical Shock Hazard

Disconnect power before servicing.

Replace all parts and panels before operating.

Failure to do so can result in death or electrical shock.

### DOOR INTERLOCK SWITCHES



Refer to page 4-16 for the procedure for accessing the door interlock switches.

1. Unplug microwave oven or disconnect power.
2. Disconnect the wires from the interlock switch terminals.
3. Set the ohmmeter to the R x 1 scale.
4. Touch the ohmmeter test leads to the terminals of the primary or secondary switch (normally-open). The meter should indicate an open (infinite) circuit.
5. Touch the ohmmeter test leads to the terminals of the monitor switch (normally-closed). The meter should indicate a closed ( $0 \Omega$ ) circuit.

**NOTE:** Pressing the actuator button on the switches should result in opposite readings (normally-open should read closed, and normally-closed should read open).

### FC THERMOSTAT



Refer to page 4-19 for the procedure for accessing the FC thermostat.

1. Unplug microwave oven or disconnect power.
2. Disconnect one of the wires from the thermostat terminals.
3. Set the ohmmeter to the R x 1 scale.
4. Touch the ohmmeter test leads to the thermostat terminals. The meter should indicate a closed ( $0 \Omega$ ) circuit.



## ⚠ WARNING

### Electrical Shock Hazard

Disconnect power before servicing.

Replace all parts and panels before operating.

Failure to do so can result in death or electrical shock.

### FC MOTOR



Refer to page 4-19 for the procedure for accessing the FC motor.

1. Unplug microwave oven or disconnect power.
2. Disconnect one of the wires from the FC motor terminals.
3. Set the ohmmeter to the R x 100K scale.
4. Touch the ohmmeter test leads to the FC motor connector pins. The meter should indicate  $21.5 \pm 5 \Omega$ .

### FC RING HEATER



Refer to page 4-19 for the procedure for accessing the FC ring heater.

1. Unplug microwave oven or disconnect power.
2. Disconnect one of the wires from the FC ring heater terminals.
3. Set the ohmmeter to the R x 1 scale.
4. Touch the ohmmeter test leads to the FC ring heater terminals. The meter should indicate  $9 \pm 2 \Omega$ .



## ⚠ WARNING

### Electrical Shock Hazard

Disconnect power before servicing.

Replace all parts and panels before operating.

Failure to do so can result in death or electrical shock.

### FC THERMISTOR



Refer to page 4-22 for the procedure for accessing the FC thermistor.

1. Unplug microwave oven or disconnect power.
2. Disconnect one of the wires from the FC thermistor terminals.
3. Set the ohmmeter to the R x 100K scale.
4. Touch the ohmmeter test leads to the FC thermistor connector pins. The meter should indicate  $230\text{ K}\Omega \pm 20\%$  @  $77^\circ\text{F}$  ( $25^\circ\text{C}$ ).

### CAVITY THERMOSTAT & HUMIDITY SENSOR



Refer to page 4-22 for the procedure for accessing the cavity thermostat and humidity sensor.

1. Unplug microwave oven or disconnect power.
2. Disconnect one of the wires from the cavity thermostat terminals, or disconnect the wire connector for the humidity sensor from the relay control board.
3. **To test the cavity thermostat:**
  - a) Set the ohmmeter to the R x 1 scale.
  - b) Touch the ohmmeter test leads to the thermostat terminals. The meter should indicate a closed ( $0\ \Omega$ ) circuit.
4. **To test the humidity sensor:**
  - a) Set the ohmmeter to the R x 1K scale.
  - b) Touch the ohmmeter test leads to sensor connector pins 1 and 3, and then 2 and 3. The meter should indicate approximately  $2.8\text{ K}\Omega$  @  $77^\circ\text{F}$  ( $25^\circ\text{C}$ ).

## ⚠ WARNING



### Electrical Shock Hazard

Disconnect power before servicing.

Replace all parts and panels before operating.

Failure to do so can result in death or electrical shock.

## GRILL THERMOSTAT



Refer to page 4-24 for the procedure for accessing the grill thermostat.

1. Unplug microwave oven or disconnect power.
2. Disconnect one of the wires from the thermostat terminals.
3. Set the ohmmeter to the R x 1 scale.
4. Touch the ohmmeter test leads to the thermostat terminals. The meter should indicate a closed ( $0 \Omega$ ) circuit.

## GRILL ELEMENTS

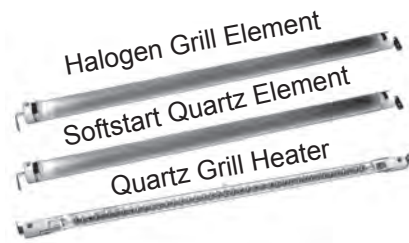

Refer to page 4-24 for the procedure for accessing the grill elements.

1. Unplug microwave oven or disconnect power.
2. Disconnect one of the wires from the grill element terminals.
3. Set the ohmmeter to the R x 1 scale.
4. Touch the ohmmeter test leads to the element terminals. The meter should indicate as follows:

Halogen Grill Element =  $2 \pm 1 \Omega$

Softstart Quartz Element =  $6 \pm 2 \Omega$

Quartz Grill Heater =  $29 \pm 5 \Omega$





## ⚠ WARNING

### Electrical Shock Hazard

Disconnect power before servicing.

Replace all parts and panels before operating.

Failure to do so can result in death or electrical shock.

### FC THERMOACTUATOR



Refer to page 4-27 for the procedure for accessing the FC thermoactuator.

1. Unplug microwave oven or disconnect power.
2. Disconnect one of the wires from the thermoactuator terminals.
3. Set the ohmmeter to the R x 1K scale.
4. Touch the ohmmeter test leads to the thermoactuator terminals. The meter should indicate  $1.2\text{ K} \pm 0.5\text{ K}\Omega$ .

### MAGNETRON THERMISTOR

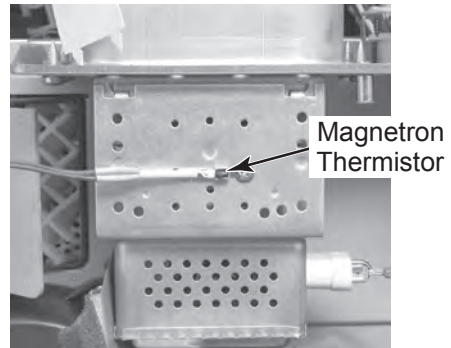

Refer to page 4-27 for the procedure for accessing the magnetron thermistor.

1. Unplug microwave oven or disconnect power.
2. Disconnect the thermistor connector from the relay control board.
3. Set the ohmmeter to the R x 1K scale.
4. Touch the ohmmeter test leads to the thermistor connector pins. The meter should indicate  $10\text{ K}\Omega \pm 5\%$  @  $77^\circ\text{F}$  ( $25^\circ\text{C}$ ).



## ⚠ WARNING

### Electrical Shock Hazard

Disconnect power before servicing.

Replace all parts and panels before operating.

Failure to do so can result in death or electrical shock.

### MAGNETRON

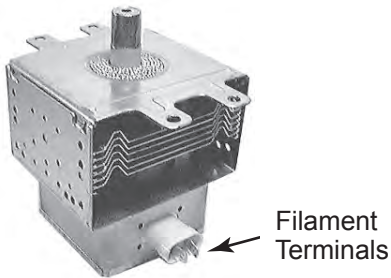

Refer to page 4-27 for the procedure for accessing the magnetron.

1. Unplug microwave oven or disconnect power.
2. Disconnect one of the wires from the magnetron filament terminals.
3. Set the ohmmeter to the R x 1 scale.
4. Touch the ohmmeter test leads to the filament terminals. The meter should indicate less than 1  $\Omega$ .

### WAVEGUIDE THERMOSTAT



Refer to page 4-29 for the procedure for accessing the waveguide thermostat.

1. Unplug microwave oven or disconnect power.
2. Disconnect one of the wires from the thermostat connectors.
3. Set the ohmmeter to the R x 100K scale.
4. Touch the ohmmeter test leads to the thermostat connector pins. The meter should indicate a closed (0  $\Omega$ ) circuit.



## **⚠ WARNING**

### **Electrical Shock Hazard**

**Disconnect power before servicing.**

**Replace all parts and panels before operating.**

**Failure to do so can result in death or electrical shock.**

### **EXHAUST FAN MOTOR CAPACITOR**



Refer to page 4-29 for the procedure for accessing the exhaust fan motor capacitor.

1. Unplug microwave oven or disconnect power.
2. Disconnect the wires from the terminals.
3. Set the ohmmeter to the R x 10K scale.
4. Touch the ohmmeter test leads to the capacitor terminals. The meter should indicate several thousand ohms and gradually return to infinity.

### **COOLING FAN MOTOR**



Refer to page 4-30 for the procedure for accessing the cooling fan motor.

1. Unplug microwave oven or disconnect power.
2. Disconnect the cooling fan motor connector from the wiring harness.
3. Set the ohmmeter to the R x 1 scale.
4. Touch the ohmmeter test leads to the motor pins. The meter should indicate  $41 \pm 5 \Omega$ .

— NOTES —

# DIAGNOSTICS & TROUBLESHOOTING

## PRIMARY, SECONDARY, AND MONITOR INTERLOCK SWITCH CHECKOUT PROCEDURE

Primary, Secondary, and Monitor Interlock Switch Checkout Procedure			
Switch	Check By	Door Open	Door Closed
Primary Interlock	<ol style="list-style-type: none"> <li>1. Unplug microwave oven or disconnect power.</li> <li>2. Disconnect the wires at the Primary Interlock Switch.</li> <li>3. Check from the common terminal (brown wires) to the normally open terminal (brown/white wires).</li> </ol>	-	+
	<ol style="list-style-type: none"> <li>1. Unplug microwave oven or disconnect power.</li> <li>2. Disconnect the wires at the Primary Interlock Switch.</li> <li>3. Check from the common terminal (brown wires) to the normally closed terminal (orange wire).</li> </ol>	+	-
Secondary Interlock	<ol style="list-style-type: none"> <li>1. Unplug microwave oven or disconnect power.</li> <li>2. Disconnect the wires at the Secondary Interlock Switch.</li> <li>3. Check from the common terminal (blue wire) to the normally open terminal (white/blue wires).</li> </ol>	-	+
Monitor Interlock	<ol style="list-style-type: none"> <li>1. Unplug microwave oven or disconnect power.</li> <li>2. Disconnect the wires at the Monitor Interlock Switch.</li> <li>3. Check from the common terminal (blue wire) to the normally closed terminal (white/red wires).</li> </ol>	+	-

(+) Continuity (-) No Continuity

**NOTE:** The circuits shown are not intended to show a complete circuit. They represent the position of the door switches during “Door Open” or “Door Closed” conditions (continuity checks only).

### Door Closed

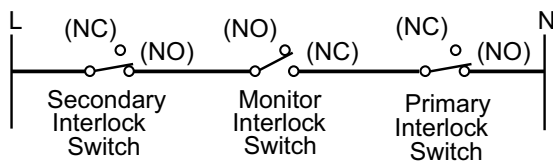

### Door Open

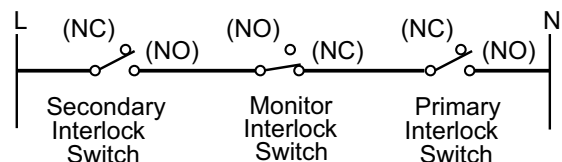

# TROUBLESHOOTING CIRCUIT TEST CHART

Cooking Mode	Magnetron	Convection Element	Grill Elements	Cooling Fan	Convection Fan	Hood Exhaust Fan
Microwave only	On			On		
Convection		On		On	On	On
Grill			On	On		On
Microwave and Grill Combination	On		On	On		On
Microwave and Convection Combination	On*	On*		On	On	On

\*Magnetron and convection elements turn on alternately, not simultaneously.

**NOTE:** After convection or grill elements are on, the cooling fan and hood exhaust fan may be on for up to 10 minutes for cooling.

## TOUCH PANEL AND RELAY CONTROL BOARD TESTS

### To access the test mode:

1. Unplug microwave oven or disconnect power.
2. Open the microwave oven door.
3. Press and hold OFF/CANCEL.
4. Plug in microwave oven or reconnect power.
5. Release OFF/CANCEL and close microwave oven door.

**NOTE:** If the OFF/CANCEL key is pressed during this diagnostic routine, you will exit the test mode.

### Test Mode Table

Screen Display	Display Explanation
UIB SW ver	Version number of UIB (user interface board) software
PB SW Ver Flash	Version number of power board (relay control board) software
FC thermistor (°C)	The temperature (°C) measured by FC (forced convection) thermistor—maximum 250°C
UIB thermistor (°C)	The temperature (°C) measured by UIB (user interface board) thermistor—ranges +/- 5°C above/below room temperature if oven has not been used recently
Magnetron thermistor (°C)	The temperature (°C) measured by magnetron thermistor—maximum 125°C

Screen Display	Display Explanation
HUM PWM	Humidity level inside unit—ranges between 8,000 and 9,500, depending on humidity level in oven cavity
Hood Key	Hood key number
Touch panel board	Touch panel error
EEPROM	Version number of PB (relay control board) EEPROM (Electrically Erasable Programmable Read-Only Memory)
MW reply error	MW relay error
Smps FB error	Power board (relay control board) error
Hum sensor error	Humidity sensor error
Cavity thermistor error	Cavity thermistor error
Magnetron thermistor error	Magnetron thermistor error
EEPROM error	Power board (relay control board) error

# MICROWAVE OVEN POWER OUTPUT TEST

1. Place 8 oz (250 mL) of lukewarm water in the center of the microwave oven.
2. Operate on HIGH power level for 2 minutes. Water should be hot.

**NOTE:** If the water takes longer than 2 minutes to heat, this may indicate either the operating voltage is lower than 110 volts or there is a problem with the microwave oven.

**NOTE:** Many of the problems listed in the chart below may be solved by power cycling: unplug microwave oven or disconnect power. After one minute, plug in microwave oven or reconnect power.

## Failure Codes Indications

Display	Likely Failure Condition	Recommended Repair Procedure
F1.E1	Relay control board defective	<ol style="list-style-type: none"> <li>1. Unplug microwave oven or disconnect power.</li> <li>2. Replace the relay control board.</li> <li>3. Plug in microwave oven or reconnect power.</li> </ol>
F2.H1	Hood keys stuck	<ol style="list-style-type: none"> <li>1. Unplug microwave oven or disconnect power.</li> <li>2. Replace hood/light switch.</li> <li>3. Plug in microwave oven or reconnect power.</li> </ol>
F2.H2	Hood/light switch defective	<ol style="list-style-type: none"> <li>1. Unplug microwave oven or disconnect power.</li> <li>2. Replace hood/light switch.</li> <li>3. Plug in microwave oven or reconnect power.</li> </ol>
F2.Q1	Not reading keypad inputs	<ol style="list-style-type: none"> <li>1. Unplug microwave oven or disconnect power.</li> <li>2. Replace the user interface board (UIB).</li> <li>3. Replace the door control assembly.</li> <li>4. Plug in microwave oven or reconnect power.</li> </ol>
F3.H1	Humidity sensor	<ol style="list-style-type: none"> <li>1. Unplug microwave oven or disconnect power.</li> <li>2. Check connection to relay control board.</li> <li>3. Replace humidity sensor.</li> <li>4. If problem persists, replace relay control board.</li> <li>5. Plug in microwave oven or reconnect power.</li> </ol>
F3.T1	UIB (user interface board) thermistor	<ol style="list-style-type: none"> <li>1. Unplug microwave oven or disconnect power.</li> <li>2. Check the connections from the UIB to the relay control board.</li> <li>3. If problem persists, replace relay control board.</li> <li>4. If the problem persists, replace the UIB.</li> <li>5. Plug in microwave oven or reconnect power.</li> </ol>
F3.T2	FC thermistor	<ol style="list-style-type: none"> <li>1. Unplug microwave oven or disconnect power.</li> <li>2. Check FC thermistor connection.</li> <li>3. Replace the FC thermistor.</li> <li>4. If problem persists, replace the relay control board.</li> <li>5. Plug in microwave oven or reconnect power.</li> </ol>
F3.T4	Magnetron thermistor	<ol style="list-style-type: none"> <li>1. Unplug microwave oven or disconnect power.</li> <li>2. Check magnetron thermistor connection.</li> <li>3. Replace the magnetron thermistor.</li> <li>4. If problem persists, replace the relay control board.</li> <li>5. Plug in microwave oven or reconnect power.</li> </ol>
F6	MW relay	<ol style="list-style-type: none"> <li>1. Unplug microwave oven or disconnect power.</li> <li>2. Check the cable from P85 to inverter.</li> <li>3. Check to see if the relay (4903 on relay board) contact has welded closed.</li> <li>4. If problem persists, replace relay board.</li> <li>5. If there is still a problem, replace relay control board.</li> <li>6. Plug in microwave oven or reconnect power.</li> </ol>

Continued on the next page.

<b>Display</b>	<b>Likely Failure Condition</b>	<b>Recommended Repair Procedure</b>
F7	Power to magnetron interrupted	<ol style="list-style-type: none"> <li>1. Unplug microwave oven or disconnect power.</li> <li>2. After 40 seconds, check to see whether this solves the problem.</li> <li>3. Check cooling fan operation.</li> <li>4. Check the magnetron.</li> <li>5. Check P65 connection on the relay control board.</li> <li>6. Check the P56 to P66 connection between relay board and relay control board.</li> <li>7. Check wiring to the 1200W inverter. See "Checking Inverters."</li> <li>8. Check operation of all interlock switches.</li> <li>9. Check voltage at 4903-1 on relay board. If it is 120, replace inverter. After replacing inverter, if there is no voltage, replace relay control board.</li> <li>10. Plug in microwave oven or reconnect power.</li> </ol>
F9	Relay control board communications error	<ol style="list-style-type: none"> <li>1. Unplug microwave oven or disconnect power.</li> <li>2. Check the communications cable from P66 to P56 between relay control board and relay board.</li> <li>3. If problem persists, replace the relay board and relay control board.</li> <li>4. Plug in microwave oven or reconnect power.</li> </ol>
F9.Q	Touch communication	<ol style="list-style-type: none"> <li>1. Unplug microwave oven or disconnect power.</li> <li>2. Check the communications cable from UIB to the touch panel board.</li> <li>3. If problem persists, replace the door control assembly.</li> <li>4. Plug in microwave oven or reconnect power.</li> </ol>



# CHECKING THE INVERTER

## Measure Oven Input Current

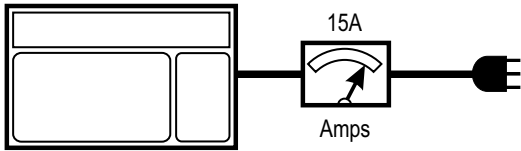

Connect an ammeter (Valhalla Scientific 2101 or equivalent recommended) to measure the input current of microwave oven when the power level is set to Level 10 at the touch panel.

### If more than 0.5A:

The 1200W inverter is probably OK. Check the magnetron. See Magnetron test in "Component Tests."

### If less than 0.5A:

There is no input to the 1200W inverter.

Check the following:

- No AC voltage supply. Check relay control board and wiring.
- No control signal. Check relay control board and wiring.

## Check the 1200W Inverter

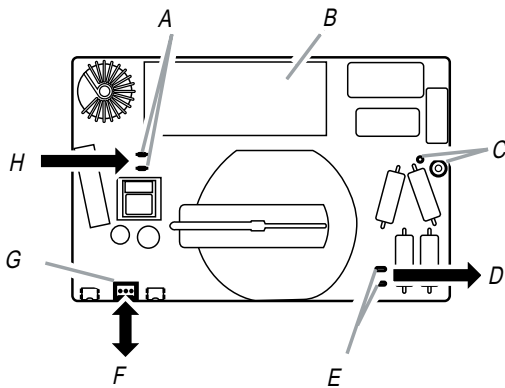

- |                                     |                          |
|-------------------------------------|--------------------------|
| A. CN702                            | E. CN703                 |
| B. Heat sink                        | F. Control signal in/out |
| C. E701                             | G. CN701                 |
| D. High-voltage output to magnetron | H. 120V AC               |

**NOTE:** Do not try to repair the inverter board, nor try to make any adjustments to the board.

### Check wiring to 1200W inverter:

1. Unplug microwave oven or disconnect power.
2. Visually inspect 4 connectors on the 1200W inverter board, CN701, CN702, CN703, E701, to see whether there are signs of overheating or any signs of failure due to loose wires, bad crimping, etc.

— NOTES —



# STRIP CIRCUITS

## INVERTER & MAGNETRON

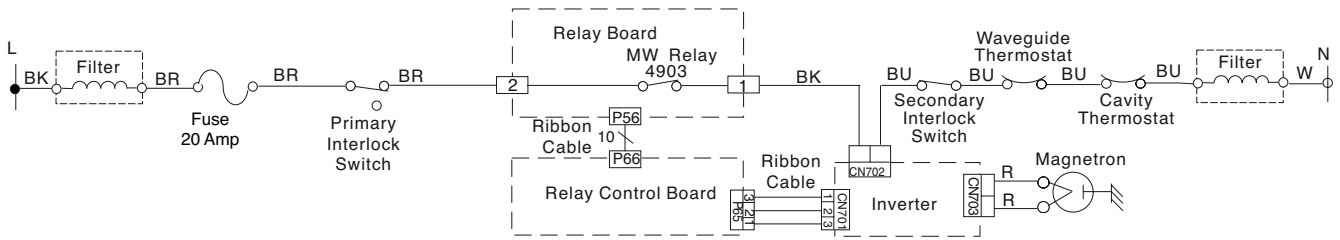

## HALOGEN GRILL HEATER

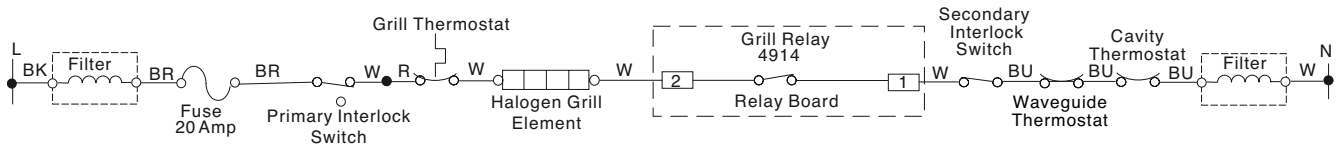

## QUARTZ GRILL HEATER

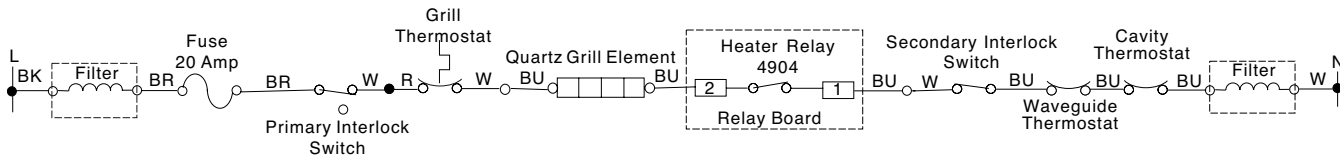

## SOFTSTART QUARTZ TUBE

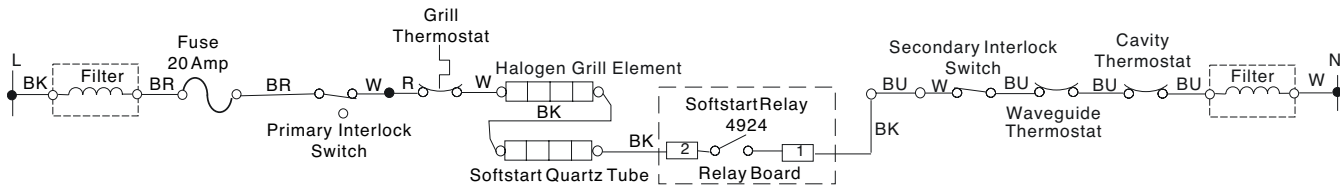

## FORCED CONVECTION

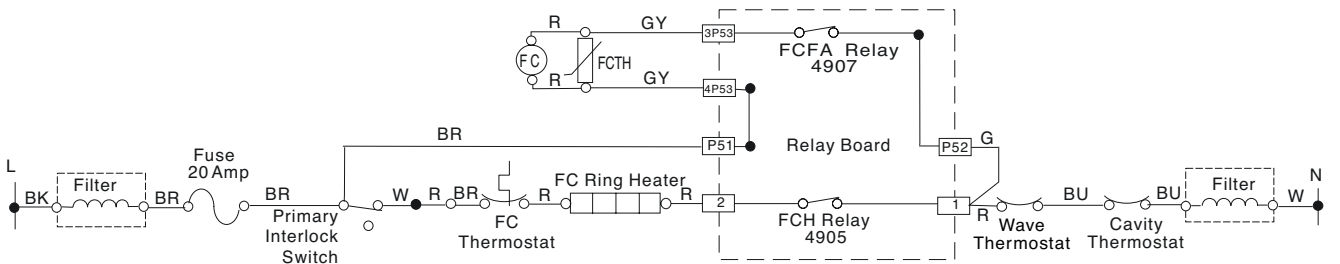

## HOOD EXHAUST FAN ON (VARIABLE SPEED)

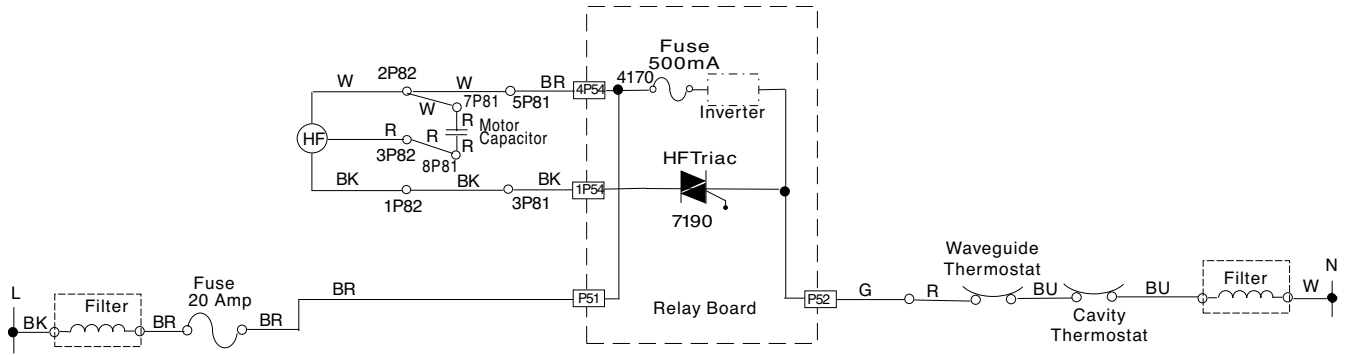

## COOLING FAN MOTOR

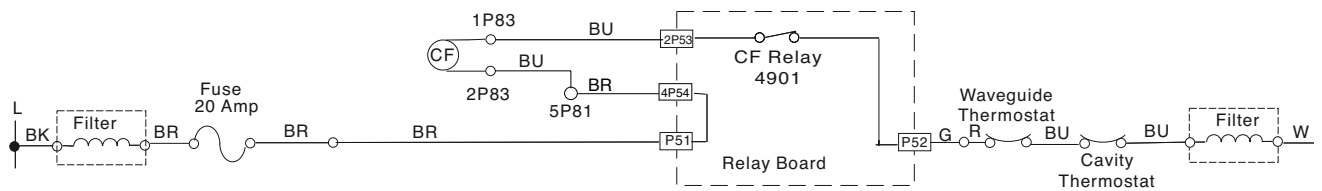

## TURNTABLE MOTOR

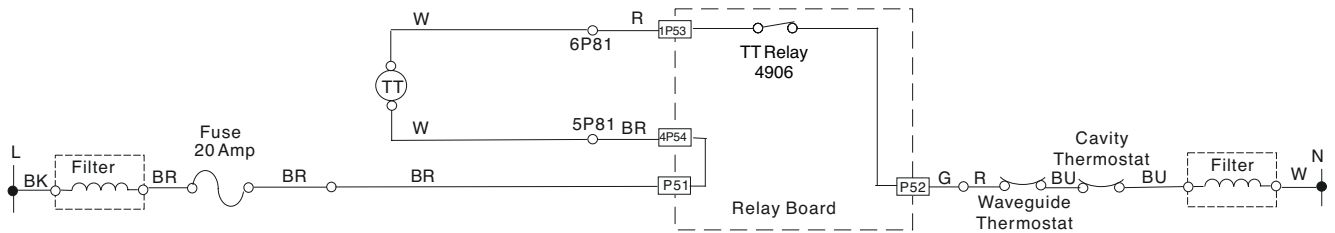

## DOOR OPEN—OVEN CAVITY LIGHT IS ON

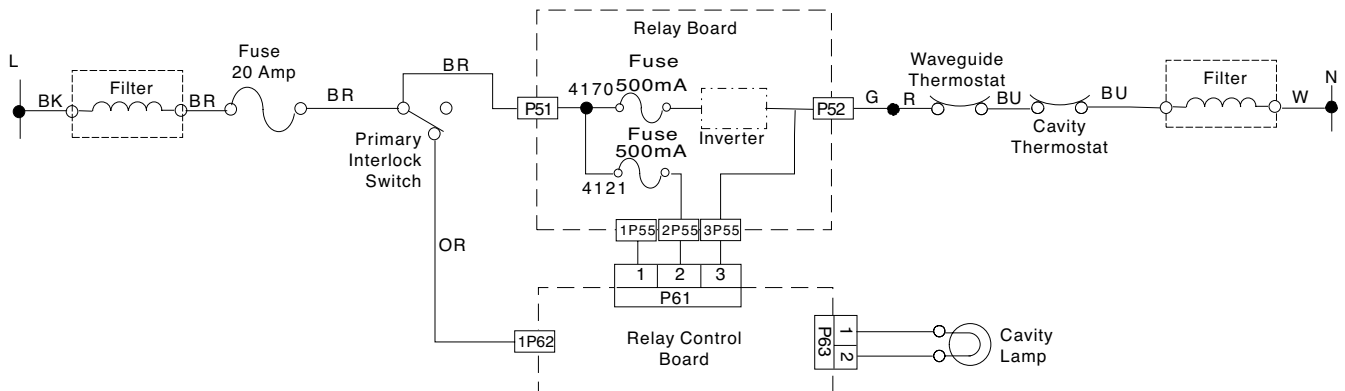



# TECH TIPS

## GRILL COOKING OPTIONS

The microwave oven provides 1200 Watts of cooking power. The grill provides 1500 watts of grilling power. The grill assembly consists of three elements (shown below), but only two are noticeable from inside the oven cavity. These two elements consist of a 1000 watt halogen, and a 500 watt quartz heater. Both bulbs operate to provide the 1500 Watts of cooking power for the grill.

The third element is a 60 volt, 600 watt Soft-Start quartz element. This element is not used for grilling heat. It is in the circuit with the other elements to control inrush current during grilling. Once the current stabilizes in the circuit, a relay on the microcomputer board opens, and eliminates power to the element.

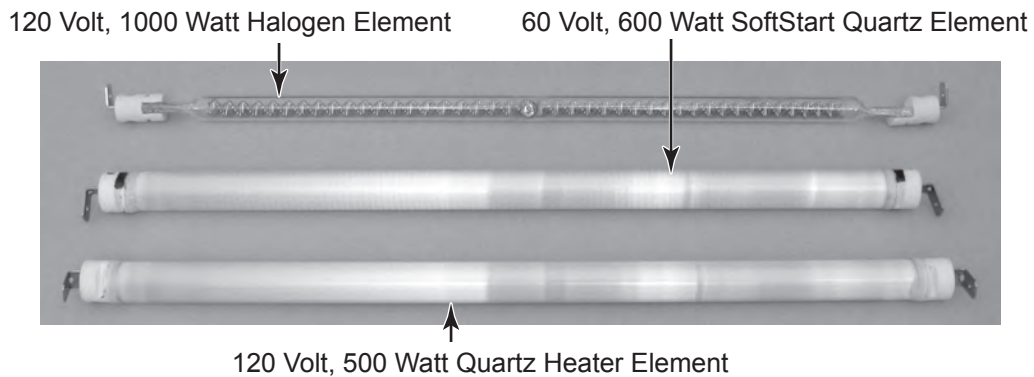

Each of the three grill elements is controlled by its own relay. At the instant of start, the quartz heater and SoftStart relays are closed (the grill relay is open). The quartz heater is On when its relay is closed to the neutral side

of the line. The halogen grill element is On when the circuit is complete from the L1 side of the line through the halogen element and the SoftStart quartz element to the neutral side of the line (the grill relay is open at the instant of start).

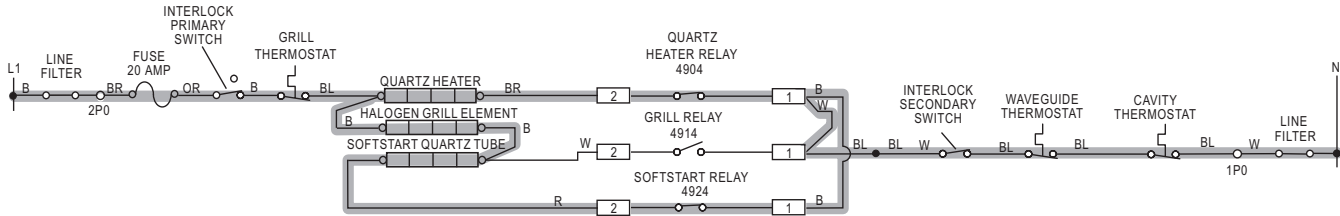

### Instant Of Start—Grill Relay Is Open

As soon as the current in the circuit stabilizes, the grill relay closes, and provides a “path of least resistance” to the neutral side of the line through the closed relay, providing a circuit for the halogen grill element to operate. The current through the SoftStart quartz element is

opened due to the path of least resistance. When grilling, the halogen element glows all the time. The SoftStart quartz element will never glow during the grill mode, although it is still providing constant heat.

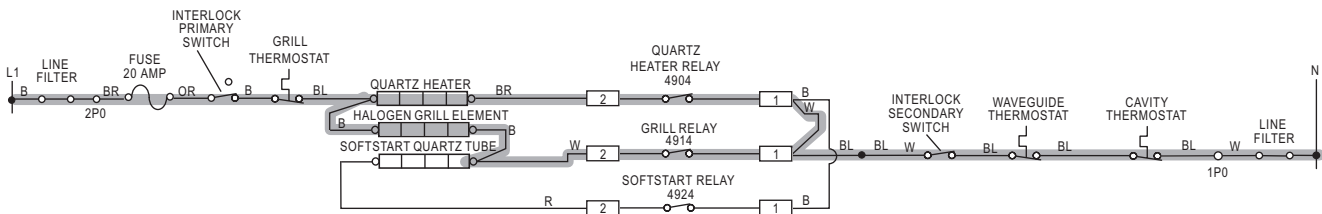

### Grilling—All Relays Are Closed

The quartz heater element is controlled by its relay during combination grill and microwave cooking. When grilling begins, the quartz heater relay closes, and activates the quartz heater

element. The quartz heater element cycles on for up to 40% of the grilling time, depending on the type of food that is being grilled.

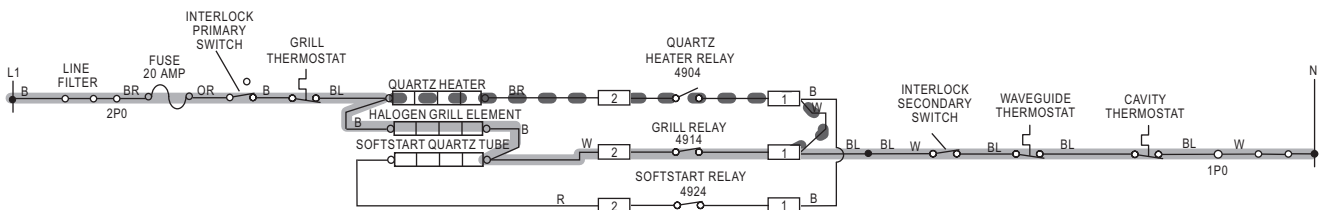

**NOTE:** Dotted line indicates that the quartz heater relay is cycling.

### Combination Grilling—The Quartz Heater Relay Opens & Closes Intermittently Depending On The Type Of Food Being Grilled



During oven grilling, only the halogen element glows (the quartz element is operational, but not noticeable).



The grill is controlled by a grill thermostat. The thermostat will open when the temperature at the top of the grill assembly reaches 293°F/145°C. The thermostat is located on the grill element cover, and is accessible by removing the cabinet.

### To remove the quartz or halogen grill element from the oven cavity:

- a) Pull the guard down and remove it from the top of the oven cavity.

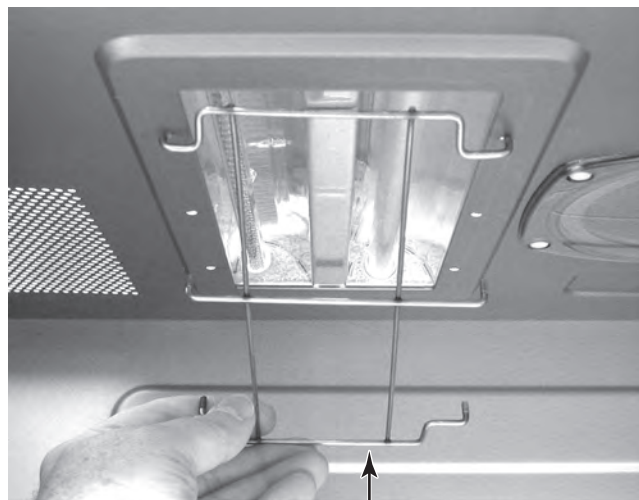

Grill Element Guard

- b) Remove the halogen and quartz heater elements by sliding them out of the holes in the mounting bracket.



Halogen Element

Quartz Heater Element

# HIGH VOLTAGE INVERTER POWER SUPPLY TEST

**NOTE:** Do not attempt to repair the high voltage inverter power supply board. Replace the complete inverter board assembly.

	<b>⚠ WARNING</b>
	<b>Electrical Shock Hazard</b> Power is present during the following tests.

Verify proper operation of the inverter board by performing the following two tests. It is recommended to use an AC line input current amp meter for testing.

## TEST #1

1. Disconnect the two wires from the magnetron terminals.
2. Place 1 liter of water into the oven cavity.
3. Program the oven for 1 minute at full power.
4. Press START. While the oven is operating, the amp meter should indicate between 1.0 and 1.7 amps. After approximately 23 seconds, the oven will turn off, and the display will indicate an **F7** error code.
5. If the current is within the range indicated in the chart, proceed to “Test #2” on the next page. If not, replace the inverter board.

CONNECTORS	METER READING	SYMPTOM
Using Magnetron Wires (CN703)	1.0 to 1.7 Amperes	Oven turns off in 23 seconds F7 error code displayed

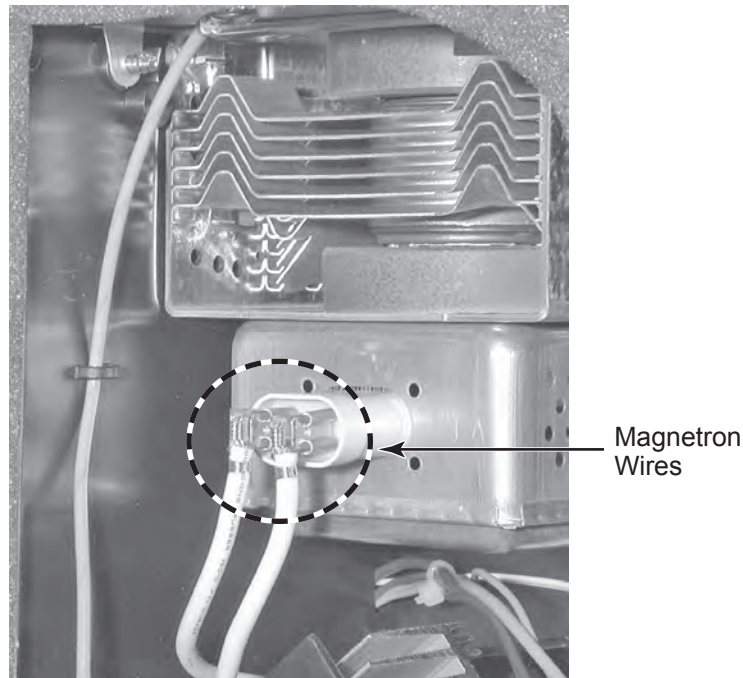

## TEST #2

1. Leave the magnetron wires disconnected and disconnect connector P65 from the relay control board.
2. Program the oven for high power for 1 minute.
3. Press START and observe the meter. It should indicate between 0.4 and 0.8 amps. After approximately 3 seconds, the oven will turn off, and the display will indicate an **F7** error code.
4. If the current is within the range indicated in the chart, the inverter power supply is working properly. If not, replace the inverter board.

CONNECTORS	METER READING	SYMPTOM
Unplug Relay Control Board P65 (CN701)	0.4 to 0.8 Amperes	Oven turns off in 3 seconds F7 error code displayed

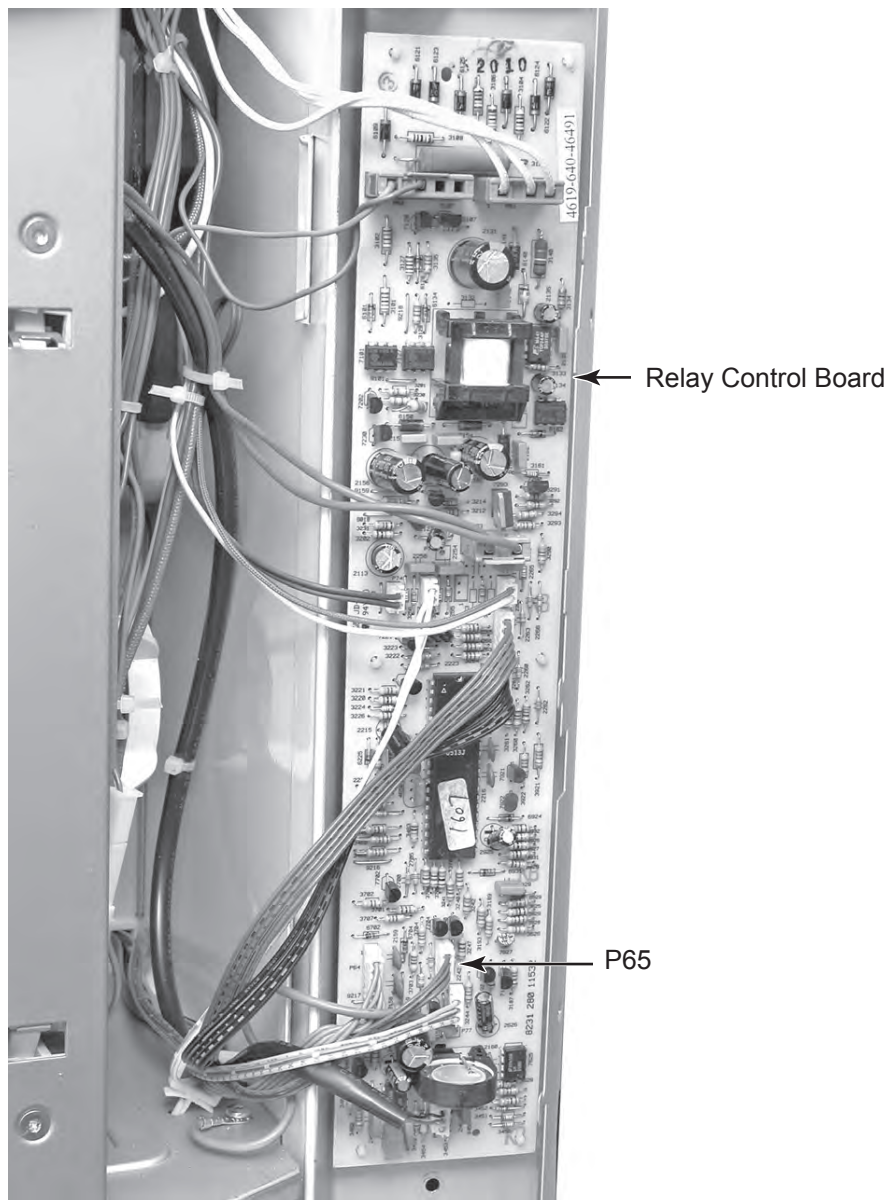

— NOTES —

— NOTES —

— NOTES —

# **PRODUCT SPECIFICATIONS AND WARRANTY INFORMATION SOURCES**

***IN THE UNITED STATES:***

**FOR PRODUCT SPECIFICATIONS AND WARRANTY INFORMATION CALL:**

**FOR WHIRLPOOL PRODUCTS: 1-800-253-1301**

**FOR KITCHENAID PRODUCTS: 1-800-422-1230**

**FOR ROPER PRODUCTS: 1-800-447-6737**

**FOR TECHNICAL ASSISTANCE WHILE AT THE CUSTOMER'S HOME CALL:**

**THE TECHNICAL ASSISTANCE LINE: 1-800-253-2870**

**HAVE YOUR STORE NUMBER READY TO IDENTIFY YOU AS AN  
AUTHORIZED SERVICER**

**FOR LITERATURE ORDERS:**

**PHONE: 1-800-851-4605**

**FOR TECHNICAL INFORMATION AND SERVICE POINTERS:**

**[www.servicematters.com](http://www.servicematters.com)**

---

***IN CANADA:***

**FOR PRODUCT SPECIFICATIONS AND WARRANTY INFORMATION CALL:**

**1-800-461-5681**

**FOR TECHNICAL ASSISTANCE WHILE AT THE CUSTOMER'S HOME CALL:**

**THE TECHNICAL ASSISTANCE LINE: 1-800-488-4791**

**HAVE YOUR STORE NUMBER READY TO IDENTIFY YOU AS AN  
AUTHORIZED SERVICER**

