



**CONSUMER CARE TECHNICAL  
EDUCATION GROUP PRESENTS**

**2003 69" HIGH  
COUNTER-DEPTH  
SIDE-BY-SIDE  
REFRIGERATOR**



**Model GC1SHAXM**

## FORWARD

This Whirlpool Job Aid, “2003 69” High Counter-Depth Side-By-Side Refrigerator” (Part No. 8178551), provides the technician with information on the installation, operation, and service of the 2003 69” High Counter-Depth Side-By-Side Refrigerator. For specific information on the model being serviced, refer to the “Use and Care Guide,” or “Tech Sheet” provided with the refrigerator.

The Wiring Diagram and Strip Circuits used in this Job Aid are typical and should be used for training purposes only. Always use the Wiring Diagram supplied with the product when servicing the unit.

## GOALS AND OBJECTIVES

The goal of this Job Aid is to provide information that will enable the service technician to properly diagnose malfunctions and repair the 2003 69” High Counter-Depth Side-By-Side Refrigerator.

The objectives of this Job Aid are to:

- Understand and follow proper safety precautions.
- Successfully troubleshoot and diagnose malfunctions.
- Successfully perform necessary repairs.
- Successfully return the refrigerator to its proper operational status.

WHIRLPOOL CORPORATION assumes no responsibility for any repairs made on our products by anyone other than Authorized Service Technicians.

# TABLE OF CONTENTS

	<b>Page</b>
<b>GENERAL</b> .....	1-1
Refrigerator Safety .....	1-1
Model & Serial Number Designations .....	1-2
Model & Serial Number Label And Tech Sheet Locations.....	1-3
<b>INSTALLATION INFORMATION</b> .....	2-1
Cutout Dimensions.....	2-1
Door Removal .....	2-2
Water Hookup .....	2-6
<b>THEORY OF OPERATION</b> .....	3-1
Overview .....	3-1
User Interface .....	3-2
Electronic Control Board .....	3-4
Thermistors .....	3-4
Defrost Operation.....	3-5
Fan Operation And Delay.....	3-6
In-Door Ice .....	3-7
<b>COMPONENT ACCESS</b> .....	4-1
Component Locations .....	4-1
Removing A Refrigerator Or Freezer Light Bulb .....	4-2
Removing The Defrost Bimetal .....	4-3
Removing The Refrigerator Thermistor Housing .....	4-4
Removing The Water & Ice Dispenser Board Interface .....	4-5
Removing The Evaporator Tray .....	4-7
Removing The Control Board.....	4-8
Removing The Water Valves.....	4-9
Removing The Condenser Fan Motor.....	4-10
Removing The Compressor Terminal Box, The Relay & Overload And Run Capacitor.....	4-11

<b>COMPONENT TESTING</b> .....	5-1
Component Testing Chart .....	5-1
<b>DIAGNOSTICS &amp; TROUBLESHOOTING</b> .....	6-1
User Interface Failure Feedback.....	6-3
Troubleshooting Chart.....	6-5
Electronic Control Board Pin Locations .....	6-8
User Interface Board Pin Locations .....	6-9
Thermistor Resistance/Temperature Chart .....	6-9
<b>WIRING DIAGRAM &amp; STRIP CIRCUITS</b> .....	7-1
Wiring Diagram .....	7-1
Strip Circuits.....	7-2
<b>TECH TIPS</b> .....	8-1
Removing The Original Gasket.....	8-1

# GENERAL REFRIGERATOR SAFETY

**Your safety and the safety of others are very important.**

We have provided many important safety messages in this manual and on your appliance. Always read and obey all safety messages.



This is the safety alert symbol.

This symbol alerts you to potential hazards that can kill or hurt you and others.

All safety messages will follow the safety alert symbol and either the word “DANGER” or “WARNING.” These words mean:

**! DANGER**

**You can be killed or seriously injured if you don't immediately follow instructions.**

**! WARNING**

**You can be killed or seriously injured if you don't follow instructions.**

All safety messages will tell you what the potential hazard is, tell you how to reduce the chance of injury, and tell you what can happen if the instructions are not followed.

# MODEL & SERIAL NUMBER DESIGNATIONS

## MODEL NUMBER

<b>MODEL NUMBER</b>	G	C	1	S	H	A	X	M	Q	0	0
<b>PRODUCT GROUP</b> G = Whirlpool Gold											
<b>PRODUCT IDENTIFICATION</b> C = Counter Depth (24" Deep)											
<b>CAPACITY / CUBIC FOOT SIZE</b> 1 = 11 or 21											
<b>MODEL SERIES / SHELVES</b> S = Shelf Variation											
<b>MODEL FEATURES / PANS</b> H = Crisper Variation											
<b>MODEL FEATURE CODE</b> A = IDI W/Grille Filter											
<b>DOOR SWING</b> X = SXS											
<b>YEAR OF INTRODUCTION</b> M = 2003											
<b>COLOR CODE</b> Q = White B = Black S = Stainless											
<b>ENERGY/POWER DESIGNATOR (NUMERIC)</b> 0 = Original, 1 = 1st Change, 2 = 2nd Change, etc.											
<b>ENGINEERING CHANGE (NUMERIC)</b> 0 = Basic Release 1 = First Revision 2 = Second Revision											

## SERIAL NUMBER

<b>SERIAL NUMBER</b>	SA	R	48	10001
<b>MANUFACTURING RESPONSIBILITY</b> SA = Fort Smith, AR				
<b>YEAR OF PRODUCTION</b> R = 2004				
<b>WEEK OF PRODUCTION</b> 48th Week				
<b>PRODUCT SEQUENCE NUMBER</b>				

# MODEL & SERIAL NUMBER LABEL AND TECH SHEET LOCATIONS

The Model/Serial Number label and Tech Sheet locations are shown below.

Model & Serial Number Label Location  
(On Lower Right Side Of Refrigerator Liner)



Tech Sheet Location  
(Behind Grille)



— NOTES —



# INSTALLATION INFORMATION

## CUTOUT DIMENSIONS

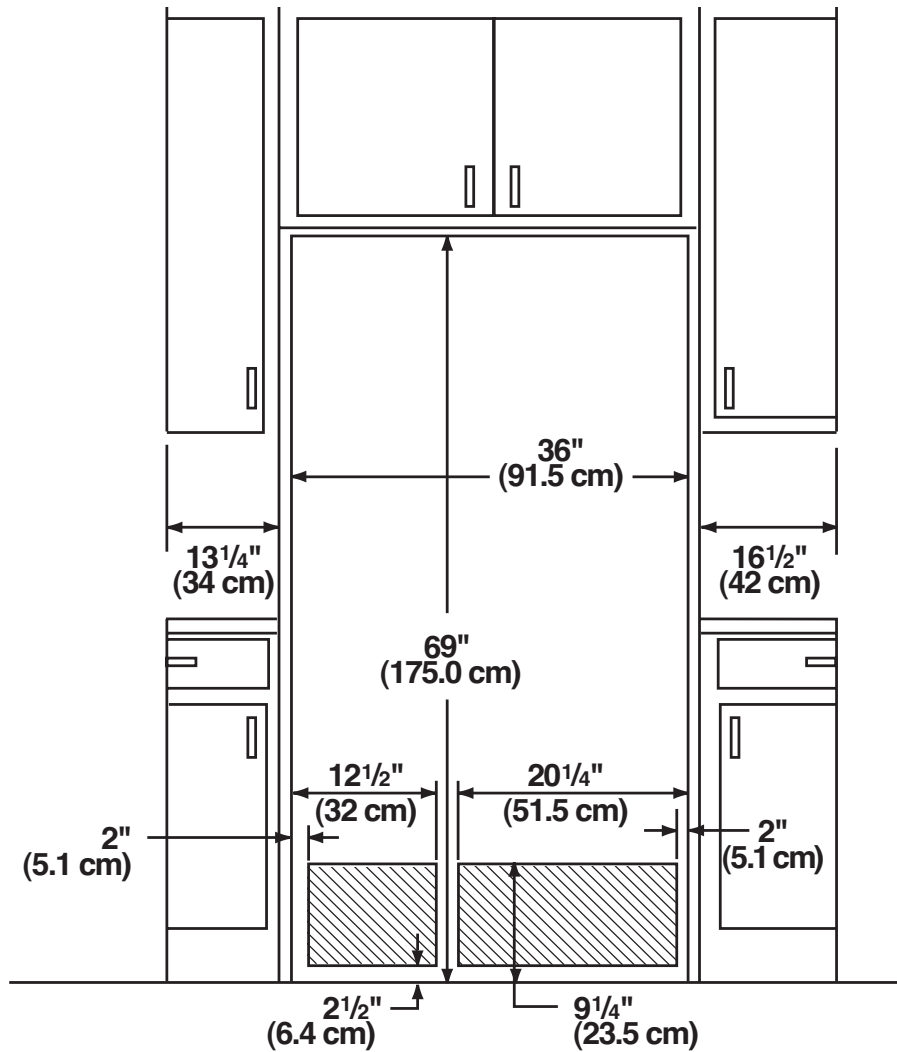

## DOOR REMOVAL

### TOOLS REQUIRED

1/2" & 5/16" Hex-Head Socket Wrenches  
Flat-Blade Screwdriver  
#1 & #2 Phillips Screwdrivers

### BEFORE YOU BEGIN

Turn the refrigerator control OFF. Unplug the refrigerator or disconnect power. Remove the food and any adjustable door or utility bins from the doors.

### HANDLE REMOVAL (OPTIONAL)

1. Using a Phillips screwdriver, remove the screws located on the inside of each door handle. Pull the door handle straight out from the door (see Illustration 1). Save the screws for reattaching the handles.
2. To make the cabinet flush, use a flat-blade screwdriver, and remove the screws attaching the door handle posts to the refrigerator cabinet. Reverse the procedure to replace the handles.

### DOOR REMOVAL

**⚠ WARNING**



**Electrical Shock Hazard**  
**Disconnect power before removing doors.**  
**Failure to do so can result in death or electrical shock.**

1. Unplug refrigerator or disconnect power.
2. Open both doors and remove the two screws from the base grille. Pull the base grille forward and remove it (see Illustration 2).

3. Close both doors and keep them closed until you are ready to lift them off the cabinet.
4. If you have a dispenser (ice or water), disconnect the water dispenser tubing, located behind the base grille on the freezer door side (see Illustration 3). To do this, press the red outer ring against the face of the fitting, and pull the dispenser tubing free. **NOTE:** On some models, you will have to remove the tubing from a hose clip.
5. Remove the top left hinge screw and cover as shown (see Illustration 4).
6. Disconnect the wiring plug as shown.

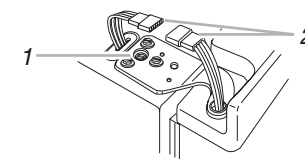

1. Do not remove screw 1  
2. Wiring plug

7. Remove the remaining left hinge screws and hinge (see Illustration 4).
8. Carefully lift the freezer door straight up and off the bottom hinge (see Illustration 5). The water dispenser tubing will remain attached to the freezer door, and will pull through the bottom left hinge. Make sure that you protect the dispenser tubing from damage when you set the door on the floor.
9. Remove the top right hinge cover and screws (see Illustration 6).
10. Lift the refrigerator door straight up and off the bottom hinge.
11. Disassemble the hinges as shown (see Illustration 7). Do not remove the screws.

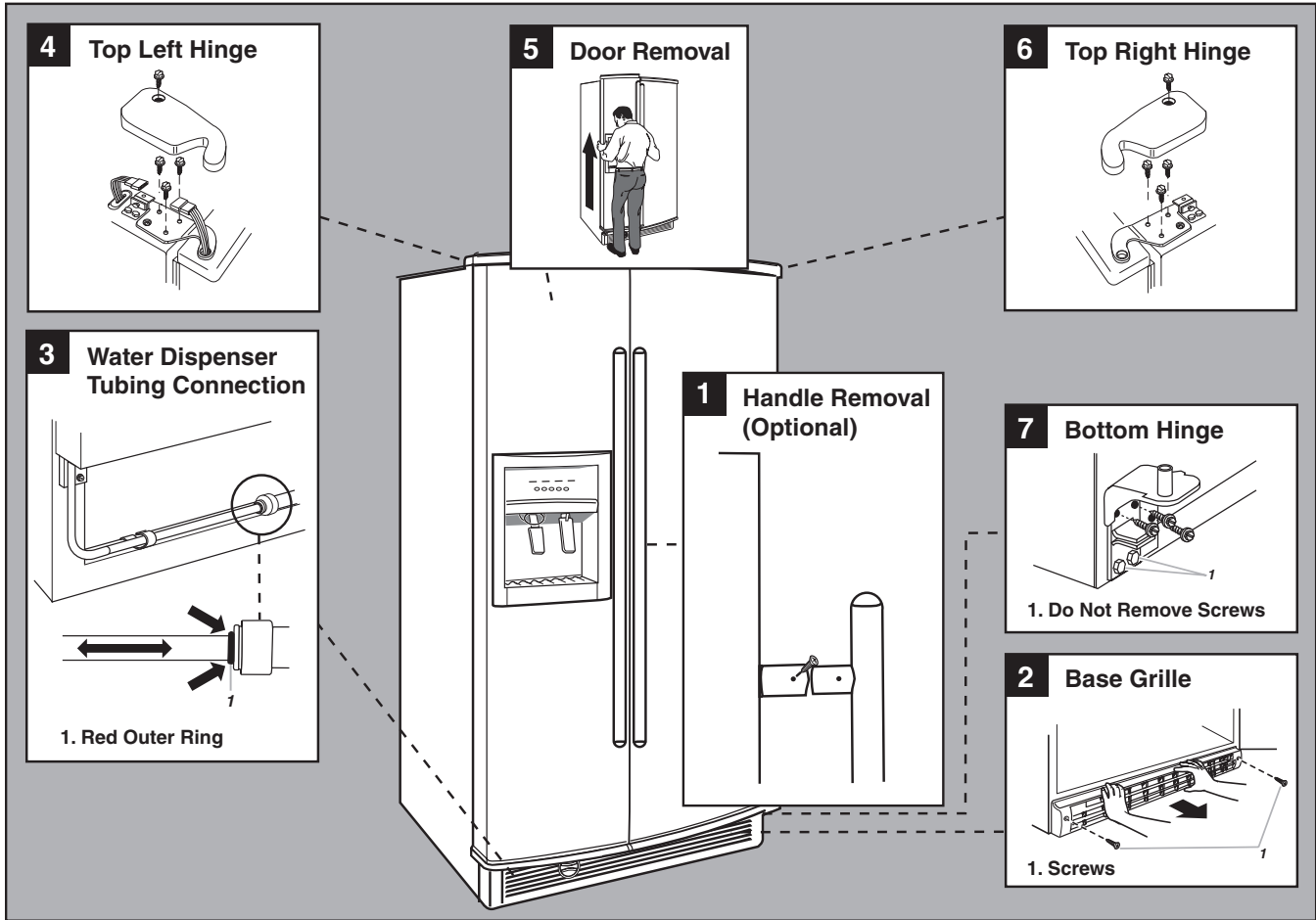

**Door Closing and Alignment**

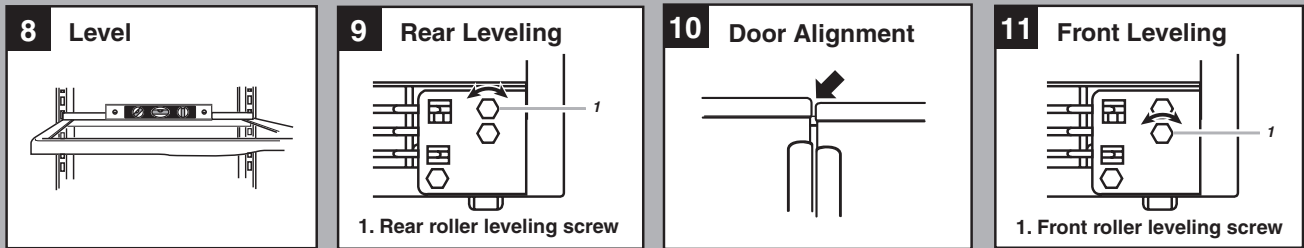

## DOOR AND HINGE REPLACEMENT

1. If removed, replace both bottom hinges and tighten the screws.
2. Carefully feed the dispenser tubing through the bottom left hinge before replacing the freezer door on the hinge.

**NOTE:** Provide additional support for the doors while the top hinges are being replaced. Do not depend on the door magnets to hold the doors in place while you are working.

3. Reconnect the water dispenser tubing by pushing the tubing into the fitting until it stops, and the black mark touches the face of the fitting (see Illustration 3). On some models, replace the tubing in the hose clip.
4. Align and replace the top left hinge (see Illustration 4) and tighten the screws.
5. Reconnect the wiring plug.

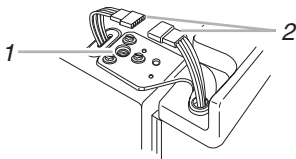

1. Do not remove screw 1  
2. Wiring plug

6. Replace the left hinge cover and screws.
7. Carefully lift the refrigerator door and set it on the bottom right hinge.
8. Align and replace the top right hinge (see Illustration 6).
9. Replace the hinge cover and screws.
10. Plug in refrigerator or reconnect power.

## DOOR CLOSING AND ALIGNMENT

### Door Closing

1. Move the refrigerator into its final position.
2. Place a level inside the refrigerator at the back of the top shelf (see Illustration 8).
3. Locate the leveling screws behind the base grille of the refrigerator on either side.
4. Use a hex-head socket wrench and adjust the rear roller leveling screws until the refrigerator is level. Turn the rear roller leveling screw to the right to raise that side of the refrigerator, or to the left to lower it (see Illustration 9). Make sure the refrigerator is level before proceeding.

### Door Alignment

If the doors are uneven after leveling the refrigerator (see Illustration 10), perform the following steps.

1. Use a hex-head socket wrench and adjust the front roller leveling screws until the doors are even. Turn the front roller leveling screw to the right to raise that side of the refrigerator, or to the left to lower it (see Illustration 11).

**NOTE:** Open and close both the refrigerator and freezer doors after each adjustment to check the door alignment.

2. Open the doors and replace the base grille. Align the grille with the bottom of the cabinet and reattach with the screws.

**NOTE:** Be sure to refasten the Tech Sheet behind the base grille.

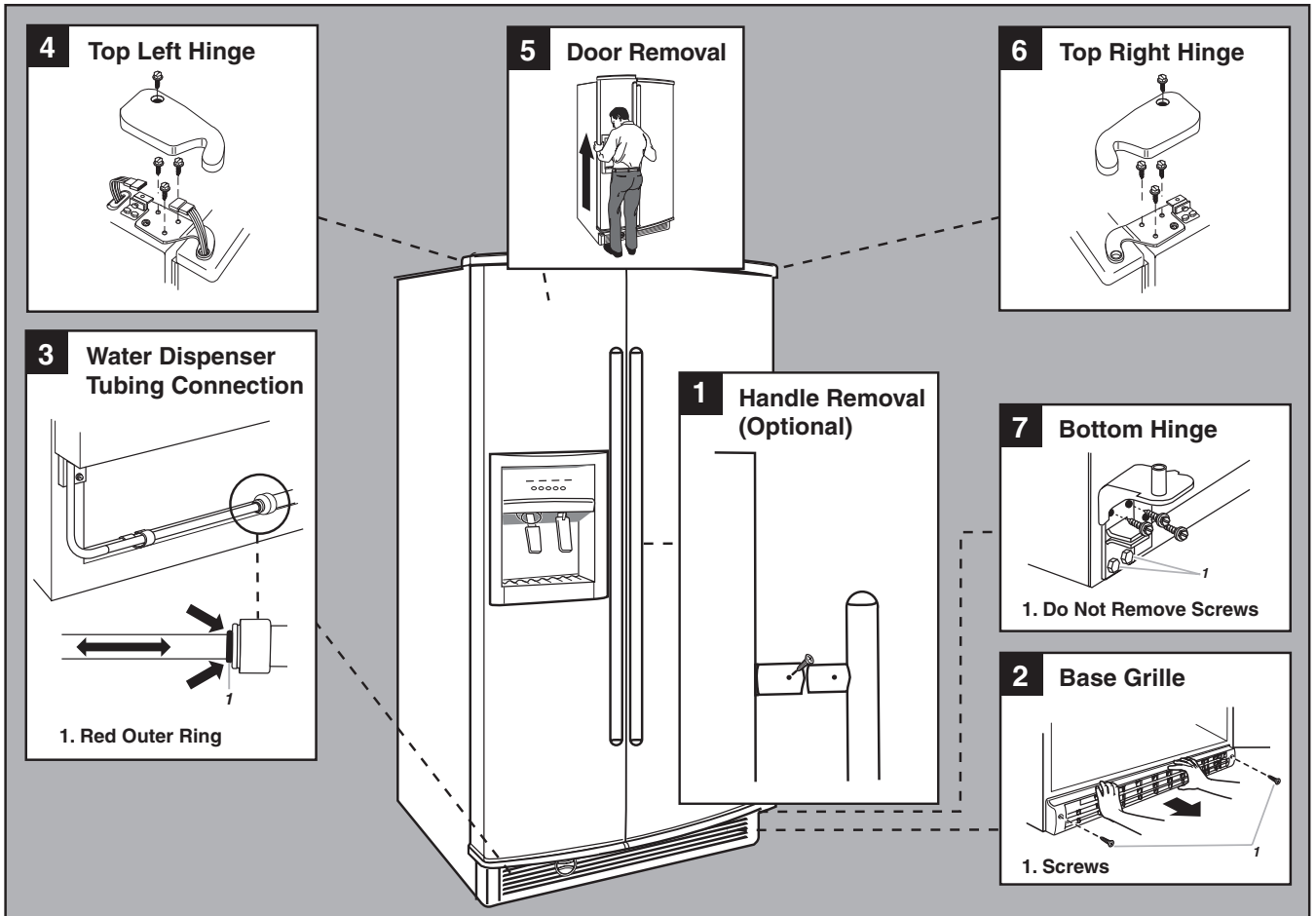

**Door Closing and Alignment**

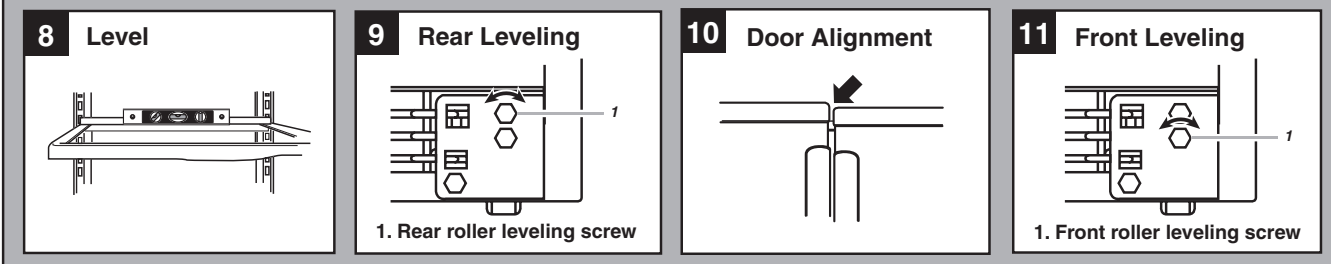

# WATER HOOKUP

**READ ALL DIRECTIONS COMPLETELY BEFORE YOU BEGIN.**

**IMPORTANT:**

In order to prevent possible leakage resulting in property damage, be sure:

1. If you are operating the refrigerator before installing the water connection, turn the ice maker to the OFF position to prevent operation without water.
2. Use copper tubing.
3. Install tubing only in areas where temperatures will remain above freezing.
4. All installations must be in accordance with local plumbing code requirements.
5. See the "Installation Guide" for further information.

## COLD WATER SUPPLY

The ice maker water valve contains a flow washer which is used as a water pressure regulator. The ice maker needs to be connected to a cold water line with water pressure between 30-120 psi. If you have questions about your water pressure, call a licensed, qualified plumber.

## REVERSE OSMOSIS WATER SUPPLY

**IMPORTANT:** The pressure of the water supply coming out of a reverse osmosis system going to the water inlet valve of the refrigerator needs to be between 30-120 psi. If a reverse osmosis water filtration system is connected to your cold water supply, the water pressure to the reverse osmosis system needs to be a minimum of 40 - 60 psi. If the water system to the reverse osmosis water system is less than 40 - 60 psi:

- Check to see whether the sediment filter in the reverse osmosis system is blocked. Replace the filter if necessary.
- Allow the storage tank on the reverse osmosis system to refill after heavy usage.

- If your refrigerator has a water filter cartridge, it may further reduce the water pressure when used in conjunction with a reverse osmosis system. Remove the water filter cartridge.

## CONNECTING TO THE REFRIGERATOR

1. Unplug refrigerator or disconnect power.
2. Remove the shipping tape from the gray, coiled water tubing on the rear of the refrigerator.

### Style 1

1. Thread the provided nut onto the coupling on the end of the copper tubing.

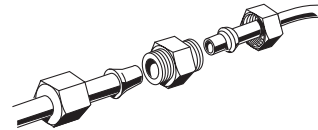

### Style 2

1. Thread the provided nut onto the water valve, as shown. First tighten the nut by hand, then tighten it with a wrench two more turns. Do not overtighten.

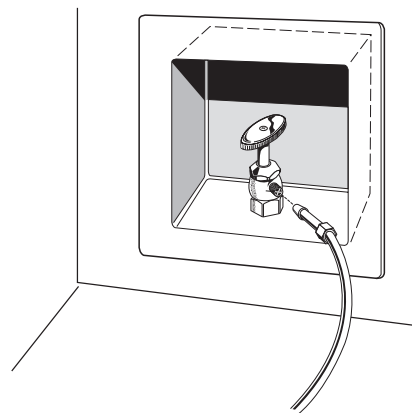

## FINAL CHECKS

1. Turn water supply valve ON and check for leaks. Tighten any connections or nuts that leak (including connections at the valve).
2. Plug in refrigerator or reconnect power. **NOTE:** It may take up to 24 hours for the ice maker to begin producing ice.

# THEORY OF OPERATION

## OVERVIEW

The design of the 69" tall counter-depth side-by-side refrigerator is similar to freestanding side-by-side refrigerators. There are, however, some very unique and important differences. This section will review the operation of this product and explain those unique differences.

The control system consists of an electronic user interface, located on the ice and water dispenser, an electronic control board, located at the left rear of the unit compartment, and thermistors, located in the refrigerator and freezer compartments. These controls communicate with each other, and manage virtually all of the functions of this refrigerator, with the exception of the in-door ice making feature.

# USER INTERFACE

The user interface allows the customer to adjust the temperatures, choose what kind of ice to be dispensed, and monitor the remaining water filter capacity. There are also lockout modes for the temperature controls and the ice and water dispenser. The temperatures are only displayed in Fahrenheit.

Each function is described below.

**ON/OFF**—Press the keypad for 2 seconds to turn the unit on and off.

When the unit is turned “off”:

- Only the central decimal point shows in both temperature displays.
- All functions are disabled.
- All lamps and lights are off.

When the unit is turned “on”:

- All functions are restored at power-up.
- Temperature settings before power-down are remembered.
- Fast Freeze and/or Grocery Savor mode will be discontinued after power-up, if selected prior to power-down.
- The compressor will wait 7 minutes to start.
- The condenser fan will wait 1 minute to start after the compressor starts.

**NOTE:** At the first power-up, the control will start in the following DEFAULT operating mode:

- Unit is in the “On” state.
- Freezer temperature is set at 0°F; Refrigerator temperature set at 37°F.
- Self Diagnostic Mode enabled for 10 minutes.
- Ice in Cube mode.
- Dispenser light “off”.
- Time to defrost will be set at 30 hours of compressor run time, or 50 hours actual time.

**FREEZER** (Temperature Settings)—Adjustment ranges from  $-5^{\circ}\text{F}$  to  $+5^{\circ}\text{F}$ . Each time the COLD or COLDER keypad is pressed, the set temperature will raise or lower  $1^{\circ}\text{F}$ . The display shows only the set temperature.

**REFRIGERATOR** (Temperature Settings)—Adjustment ranges from  $33^{\circ}\text{F}$  to  $41^{\circ}\text{F}$ . Each time the COLD or COLDER keypad is pressed, the set temperature will raise or lower  $1^{\circ}\text{F}$ . The display shows only the set temperature.

**FAST FREEZE**—Pressing this keypad places the freezer section into continuous cool-down mode for 24 hours. The control will then return to the last freezer set temperature. While in this mode, the FAST FREEZE keypad is illuminated. Pressing the keypad a second time will terminate the FAST FREEZE mode. The refrigerator section temperature is not affected.

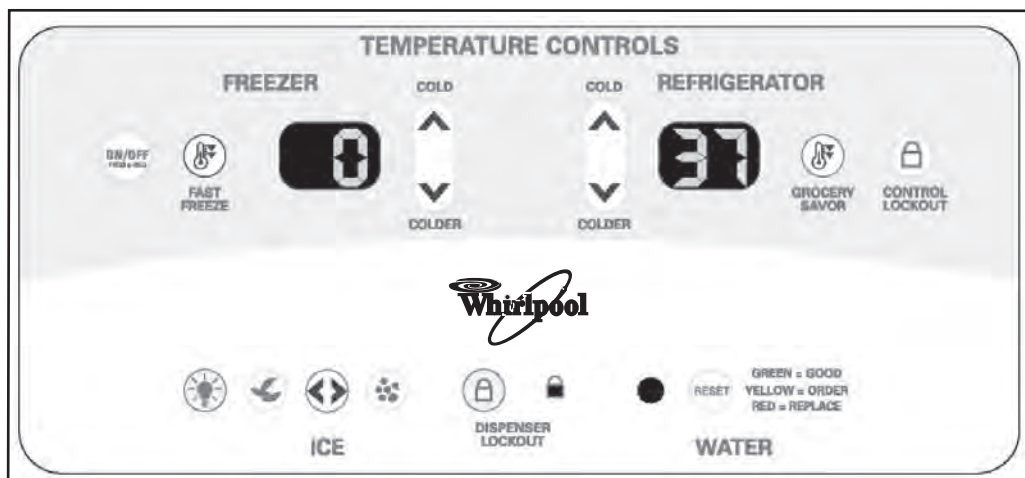



**GROCERY SAVOR**—Pressing this keypad places the refrigerator section into continuous cool-down mode for 6 hours. The temperature is regulated down to 33°F. After the 6 hour period, the control returns to the last refrigerator set temperature. Pressing the keypad a second time will terminate the GROCERY SAVOR mode. While in this mode, the GROCERY SAVOR keypad is illuminated.

**CONTROL LOCKOUT**—Pressing this keypad for 2 seconds disables all user interface control keypads relating to temperature regulation. While in this mode, the CONTROL LOCKOUT keypad is illuminated. If any other keypad is pressed, the LOCKOUT keypad indicator will blink twice. Pressing the CONTROL LOCKOUT keypad again for 2 seconds, will enable all temperature control functions.

**DISPENSER LIGHT**—Pressing this keypad will turn the dispenser light on. Pressing the keypad again will turn off the light. When in the “off” mode, the light will illuminate when either dispenser paddle is pressed.

**ICE MODE**—This keypad toggles between cubed and crushed ice. In the cubed mode, the CUBED ICE indicator will illuminate. In the crushed mode, the CRUSHED ICE indicator will illuminate.

**DISPENSER LOCKOUT**—Pressing this keypad for 2 seconds disables the ice and water dispenser functions, and the related user interface control keypads. While in this mode the DISPENSER LOCKOUT keypad is illuminated. If any other dispenser keypad or dispenser paddle is pressed, the LOCKOUT keypad indicator will blink twice. Pressing the DISPENSER LOCKOUT keypad again for 2 seconds will enable all of the dispenser functions.

**WATER FILTER INDICATOR**—The water filter indicator function is the same as on other Whirlpool refrigerators with filtered water systems. Pressing the RESET keypad for 2 seconds will reset the indicator back to green, and the counter will start over. The filter indicator can only be reset when the filter indicator light is “red,” no matter when the filter is changed. Maximum filter capacity is 400 gallons, or for a time period not to exceed 6 months.

## ELECTRONIC CONTROL BOARD

The main electronic control board is located at the right rear of the unit compartment (facing from the rear). The main electronic board communicates with the user interface. It also receives and reacts to feedback from other

sources, such as water valves, thermistors, defrost bimetal, refrigerator and freezer light switches, and the air damper. The electronic control board directly controls, or supplies power to, virtually all functions of the refrigerator.

## THERMISTORS

Temperature is regulated with the use of two thermistors that provide feedback to the main control board. One thermistor is located on the back wall of the refrigerator section, and the other is located on the left wall of the freezer section.

**NOTE:** Thermistors are very reliable and seldom fail.

The refrigerator thermistor controls:

- Motorized air baffle (damper)
- Evaporator fan (only when the air baffle is open)

The freezer thermistor controls:

- Compressor
- Condenser fan
- Evaporator fan (only when the air baffle is closed)

## DEFROST OPERATION

Defrost is controlled by the main control board, and incorporates the use of the “pulsed” defrost. However, this defrost system is uniquely different than other Whirlpool electronic refrigerators.

- Defrost is initiated by a different set of criteria (listed below).
- The bimetal/thermofuse combination switches off the defrost heater, and provides additional defrost circuit protection.
- The defrost bimetal is placed on the neutral side of the defrost heater, and the thermofuse protects the “line” side of the circuit.
- The electronic control does not “time-out” and terminate the defrost cycle. Defrost is terminated only by the opening of the bimetal switch contacts, or the opening of the thermofuse in case the bimetal fails.
- The bimetal opens at  $45^{\circ}\text{F} \pm 5^{\circ}$  ( $7^{\circ}\text{C} \pm 3^{\circ}$ ) and closes at  $19^{\circ}\text{F} \pm 5^{\circ}$  ( $-7^{\circ}\text{C} \pm 3^{\circ}$ ).
- The thermofuse will open at  $162^{\circ}\text{F}$  ( $72^{\circ}\text{C}$ ).

The defrost cycle is initiated:

- When power is connected (after the initial power-up) to the refrigerator and the bimetal is closed (unit is cold).
- With no door openings.
  - When 30 hours of compressor run time, or 50 hours actual time, has passed since the last defrost cycle.

- If a door was opened.
  - After 8 hours of cumulative compressor run time.
- The compressor runs continuously for at least 8 hours.

The following occurs when the defrost cycle is initiated:

- Cooling function switches OFF (compressor and both fans are OFF).
- The air-baffle/damper switches to the CLOSED position.
- The heater starts to heat the evaporator with the following timing:
  - 5 minutes ON, 1 minute OFF.
  - 3 minutes ON, 1 minute OFF repeatedly.
  - Bimetal thermostat opens at  $45^{\circ}\text{F} \pm 5^{\circ}$  ( $7^{\circ}\text{C} \pm 3^{\circ}$ ).

When defrost bimetal thermostat opens:

- The defrost heater is switched OFF.
- The compressor is activated after 7 minutes of drip time.
- The condenser fan is activated 1 minute after the compressor.
- The evaporator fan is activated after 10 minutes from bimetal opening, or 3 minutes after the compressor starts.
- The air baffle is opened 3 minutes after the compressor is activated, or a total time of 10 minutes from the bimetal opening.

# FAN OPERATION AND DELAY

Both the condenser and evaporator fan motors operate on DC voltage. The control board supplies 115 volts AC to each motor, where it is converted to DC.

## EVAPORATOR FAN

- Fan Start Delay—Fan is energized 3 minutes after the compressor starts.
- Fan Stop Delay—Fan is switched OFF 1 minute after the compressor stops.
- **IMPORTANT:** Evaporator fan shuts off when either the refrigerator or freezer door is opened.

## CONDENSER FAN

- Fan start delay—Fan is energized 1 minute after the compressor starts.
- Fan stops when the compressor shuts off.

## POWER FAILURE / TEMPERATURE RISE

This product has no audible alarm. However, it will alert the customer of a long power outage, or temperature rise, if the temperature rises above 17.6°F (−8°C). Should this occur, the following will happen:

- The “alert” will only be indicated on the freezer temperature display.
- The freezer temperature display blinks continually, and will show the actual freezer compartment temperature from the time the power is restored. If there are consecutive outages, the display will show the highest temperature for the entire period.
- The actual compartment temperature will display until the freezer COLD or COLDER keypad is pressed. The “alert” is terminated, and the display will revert back to the set temperature.
- All settings and memory are saved and are continued after power has been restored, i.e. FAST FREEZE, GROCERY SAVOR, and ice preference.

## DEFAULT SETTINGS

If communication between the user interface and the control board is lost for more than 3 minutes, the user interface assumes the board is working correctly. The control board stores the current temperature settings, but will go into a “default mode,” and maintain preset temperatures. Once communication is restored, the stored settings are again used.

If communication is broken between the user interface and the control board during an “ON” cycle:

### Electronic Control

- Default temperatures that will be maintained are:
  - Refrigerator section: 41°F (5°C).
  - Freezer section: 0°F (−18°C).

### User Interface

- Freezer display flashes “CF” and Set Temp alternately (Communication Fault).
- Refrigerator display flashes the Set Temperature.
- The user interface keypads will be disabled
- The ice maker will be disabled.
- The water filter status indicator light will blink, and the reset keypad will be disabled.
- The refrigerator and freezer interior lights will be off, except for the indicators above.

### Default Operation If Thermistors Fail:

- Refrigerator thermistor fails:
  - Damper and evaporator fan will be cycled “on” 15 minutes and “off” 30 minutes.
- Freezer thermistor fails:
  - Compressor and evaporator fan will run continuously.

## IN-DOOR ICE

### **IMPORTANT:**

The In-Door Ice (IDI) feature and function on this product is the same as on all other IDI refrigerators.

Although physically interchangeable with other IDI electronic controls, these control boards are unique to this product and will not function in other IDI product, nor will other IDI controls function in this product.

If replacement controls are needed, order by model number.

The IDI control board and the ice maker are powered directly from the control board. This allows the main control board to monitor the ice maker water fill, and the closing of the freezer light switch when the door is opened. When the freezer door is opened, the ice maker is temporarily disabled.

The IDI diagnostic routine is also identical, and the checkout procedure is the same. For more information on diagnostics, or IDI design and function, refer to Job Aid #4322658A.

— NOTES —

# COMPONENT ACCESS

This section instructs you on how to service components inside the 2003 69" High Counter-Depth Side-By-Side Refrigerator. The components and their locations are shown below. **NOTE:** Some of the components called out below are not serviced in this section.

## COMPONENT LOCATIONS

	<b>! WARNING</b>
	<b>Electrical Shock Hazard</b>
	<b>Disconnect power before servicing.</b>
	<b>Replace all parts and panels before operating.</b> <b>Failure to do so can result in death or electrical shock.</b>

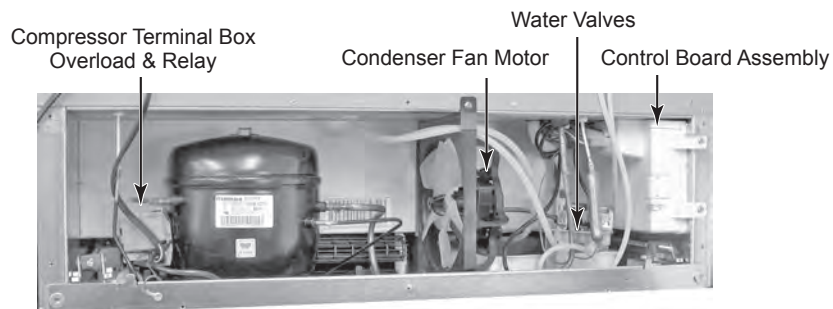
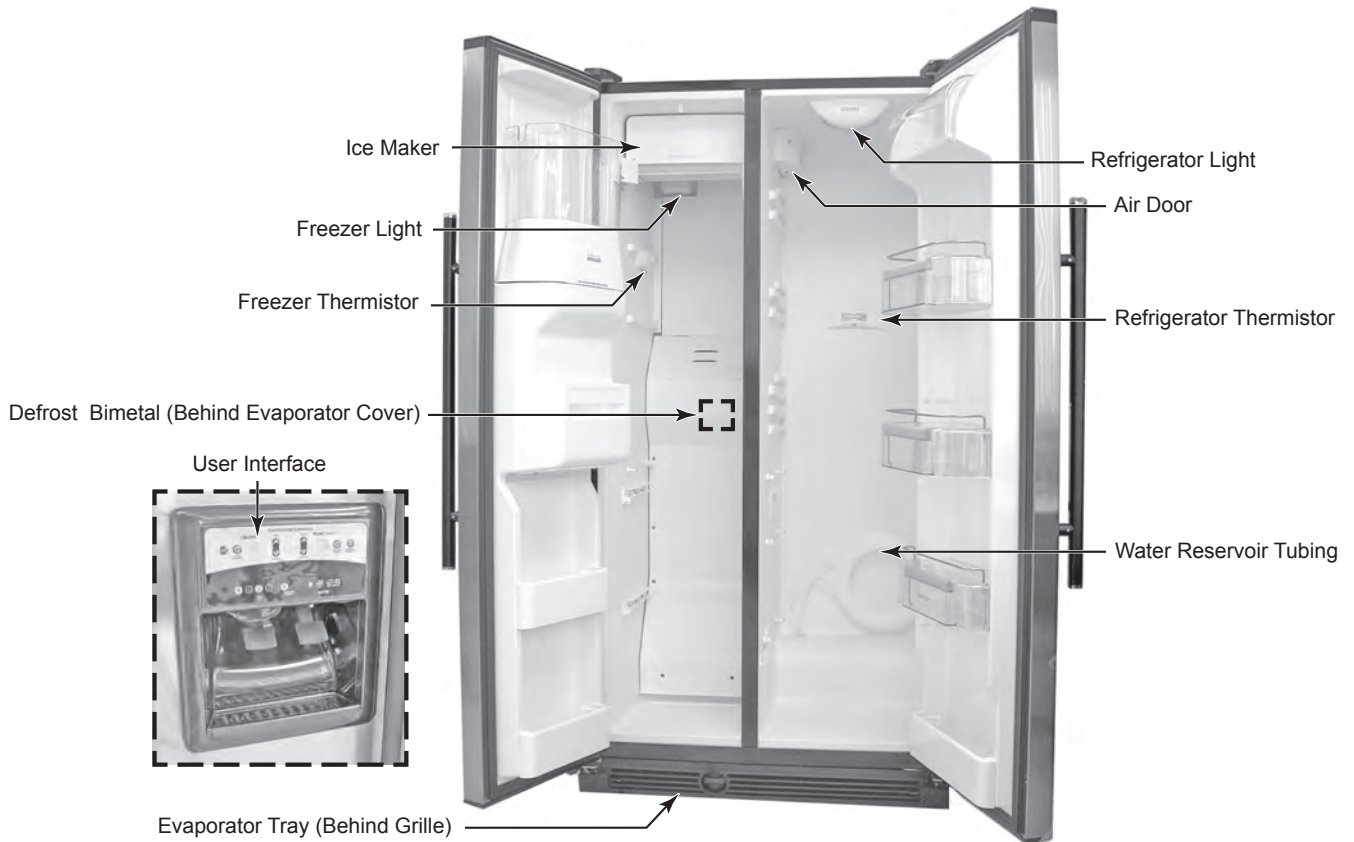

# REMOVING A REFRIGERATOR OR FREEZER LIGHT BULB

1. Unplug refrigerator or disconnect power.
2. **To remove the freezer light bulb:**
  - a) Unhook the four tabs from the light cover (located behind the in-door ice maker) and remove the cover.

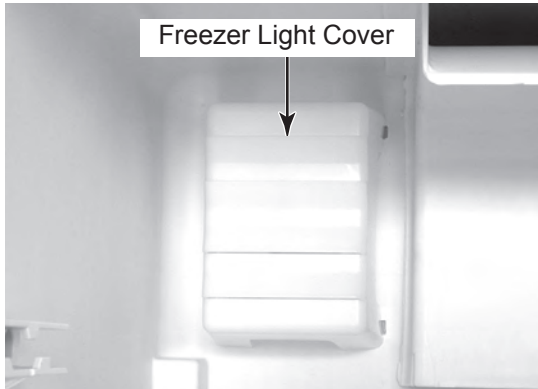

- b) Pull the light bulb out of the socket.

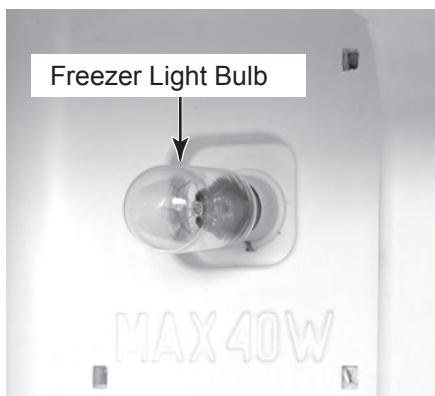

3. **To remove the refrigerator light bulb:**
  - a) Remove the screw from the lens.
  - b) Lower the back of the lens and unhook the three tabs from the liner slots.

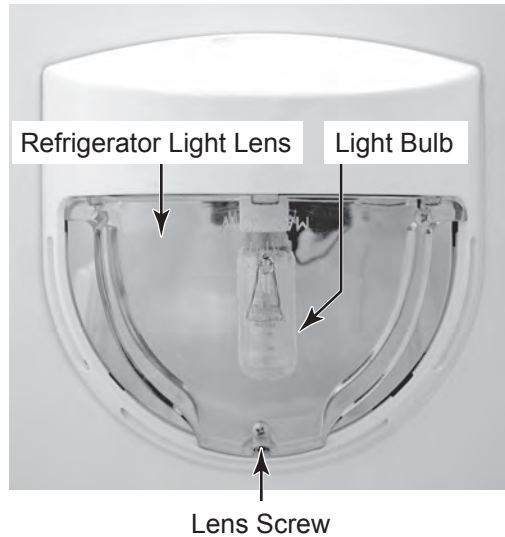

- c) Pull the light bulb so that the terminals are free of the socket and remove the bulb.





## REMOVING THE DEFROST BIMETAL

### **⚠ WARNING**



**Electrical Shock Hazard**  
**Disconnect power before servicing.**  
**Replace all parts and panels before operating.**  
**Failure to do so can result in death or electrical shock.**

1. Unplug refrigerator or disconnect power.
2. Remove the food and shelves from the freezer compartment.
3. Pull forward on center of the top air guide. Unsnap the four liner catches from the guide supports, and remove the guide.

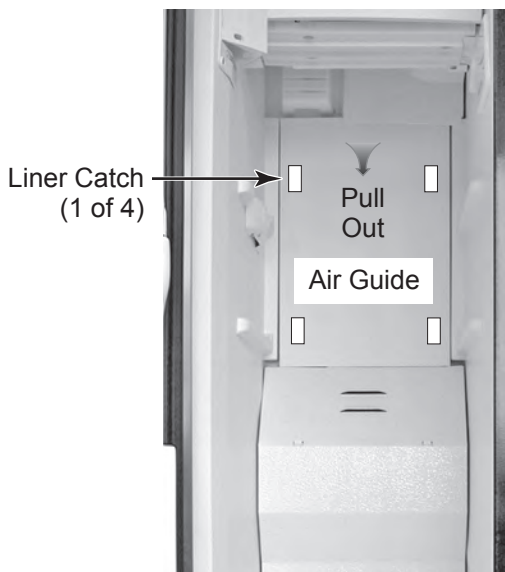

4. Remove the screw from each of the two indicated shelf supports and remove the supports (see the top right column photo).
5. Remove the four screws from the top evaporator cover.
6. Remove the four screws from the bottom evaporator cover and remove the cover.

7. Lift the top evaporator cover and unhook the two tabs from the slots in the cover, then pull the cover up around the drawer slides, and out of the unit.

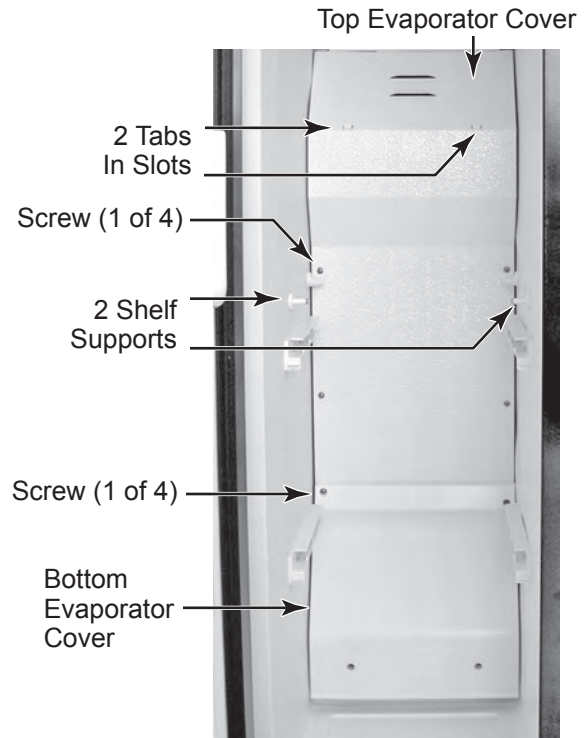

8. Cut the indicated wire tie from around the defrost bimetal wires and tubing.
9. Disconnect the two heater connectors and the evaporator fan motor connector from the defrost bimetal.
10. Unsnap the defrost bimetal from the evaporator tubing and disconnect the ground wire and 5-wire connector from the liner.

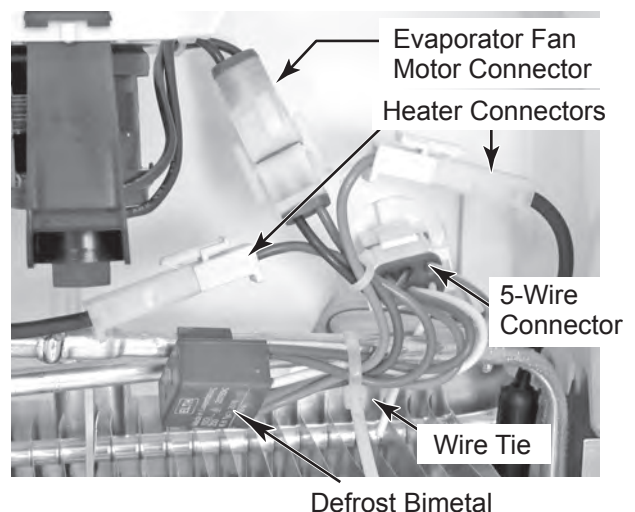

# REMOVING THE REFRIGERATOR THERMISTOR HOUSING

## **⚠ WARNING**



### **Electrical Shock Hazard**

**Disconnect power before servicing.**

**Replace all parts and panels before operating.**

**Failure to do so can result in death or electrical shock.**

1. Unplug refrigerator or disconnect power.
2. Remove the food and shelf that is in front of the refrigerator thermistor.
3. Remove the screw from the refrigerator thermistor housing and turn the housing over.

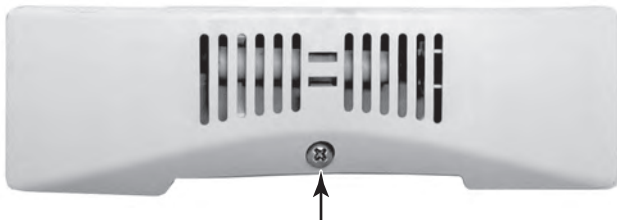

Refrigerator Thermistor Housing Screw

4. Unclip the refrigerator thermistor and wire from the housing.
5. Place the thermistor in ice water (refer to page 6-9 for the correct readings).

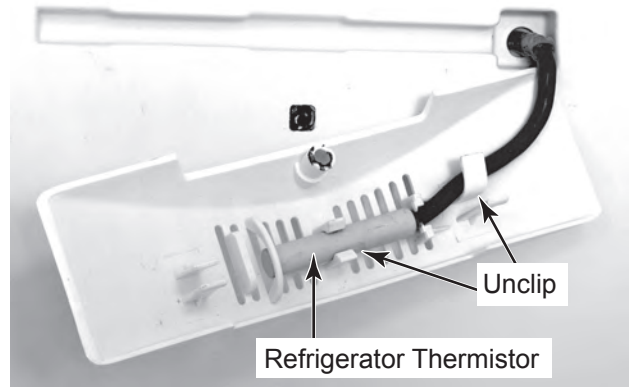

## REMOVING THE WATER & ICE DISPENSER BOARD INTERFACE

### **⚠ WARNING**



**Electrical Shock Hazard**  
Disconnect power before servicing.  
Replace all parts and panels before operating.  
Failure to do so can result in death or electrical shock.

1. Unplug refrigerator or disconnect power.
2. Lift the overflow tray from the water and ice dispenser.



3. Push down on the bottom of the front cover housing of the water and ice dispenser, then pull the housing out at the bottom, and unhook it at the top (see the top photo in the right column).

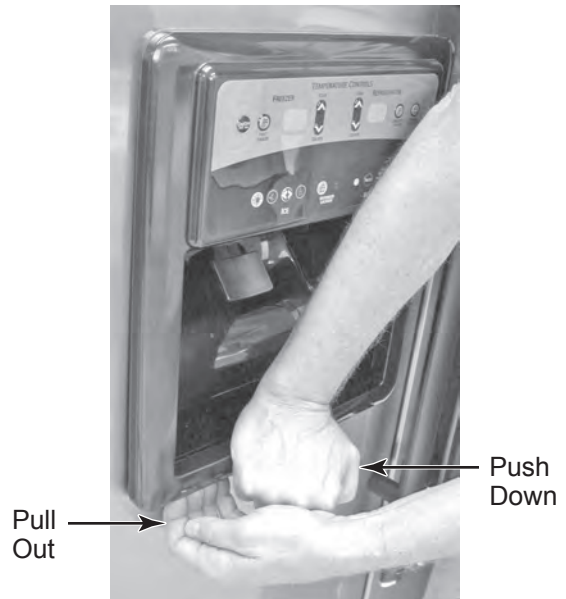

4. Disconnect the two edge connectors from the board interface and remove the housing assembly.

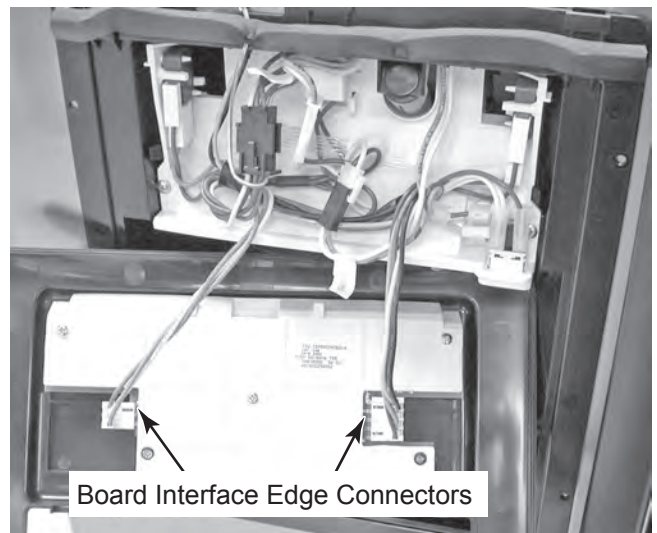

**Continued on the next page.**

5. Remove the three screws from the interface board cover and remove the cover.

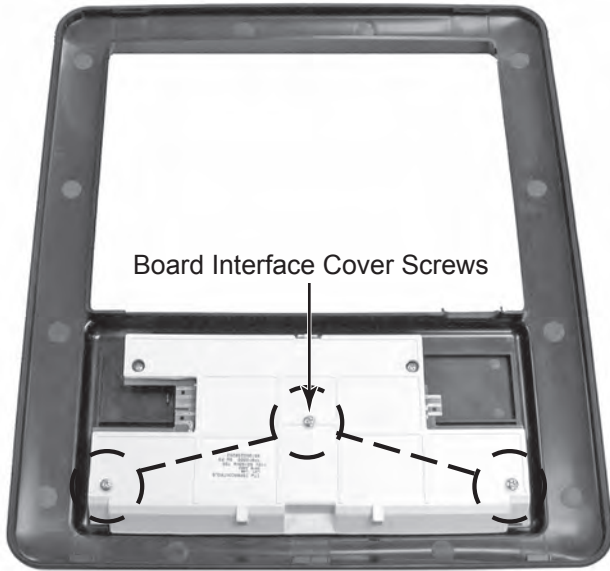

**IMPORTANT:** Due to static electricity, always handle circuit boards by the edges to avoid damage to the circuitry.

6. Remove the two screws from the interface board and remove the board from the housing.

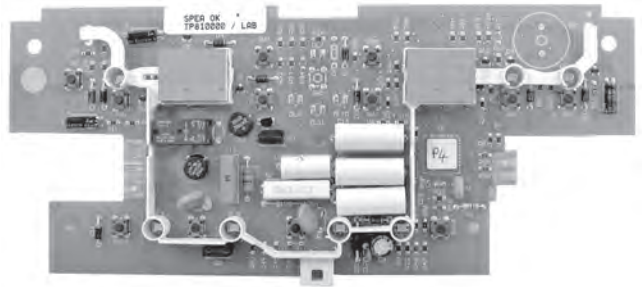
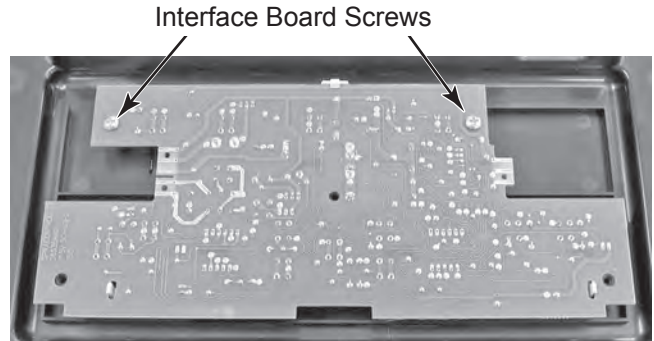

Interface Board

## REMOVING THE EVAPORATOR TRAY

### **WARNING**



#### **Electrical Shock Hazard**

**Disconnect power before servicing.**

**Replace all parts and panels before operating.**

**Failure to do so can result in death or electrical shock.**

**NOTE:** The evaporator tray is not customer removable.

1. Unplug refrigerator or disconnect power.
2. Remove the two screws from the bottom grille and remove the grille.

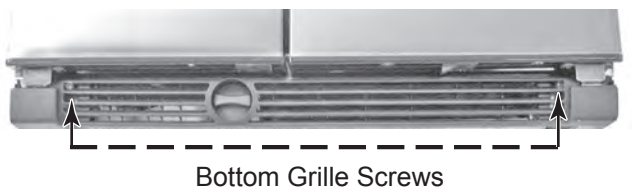

3. Remove the two 9/32" (7 mm) hex-head screws from the filter bracket, and push the bracket assembly to the right as far as it will go.

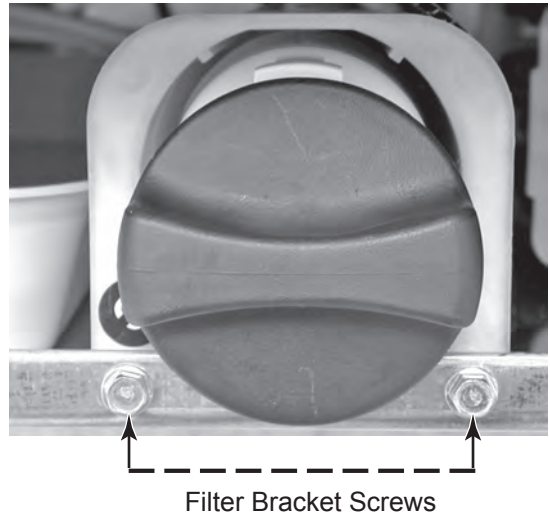

4. Pull the evaporator tray out from below the unit and remove it.

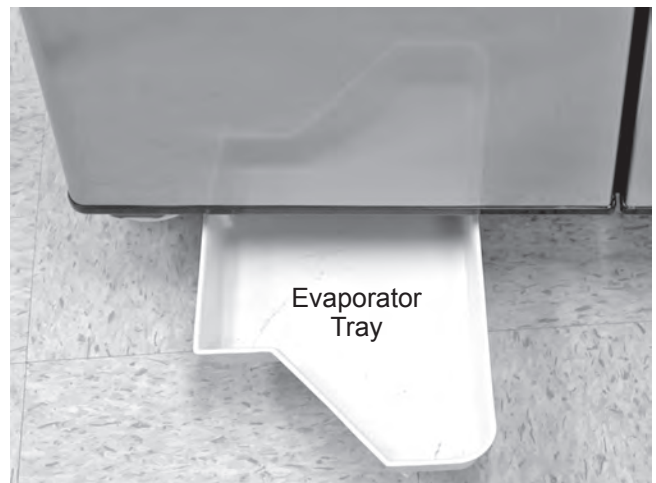

# REMOVING THE CONTROL BOARD

## ⚠ WARNING



### Electrical Shock Hazard

Disconnect power before servicing.

Replace all parts and panels before operating.

Failure to do so can result in death or electrical shock.

1. Unplug refrigerator or disconnect power.
2. Remove the six screws from the unit compartment cover and remove the cover.



Unit Compartment Cover Screws (3 of 6)

3. Remove the two screws from the control board housing cover and pull the assembly out of the unit.



4. Using a small screwdriver, start at the top of the cover, and pry the tabs on the housing from the loops on the cover. When all the loops are free, remove the cover.

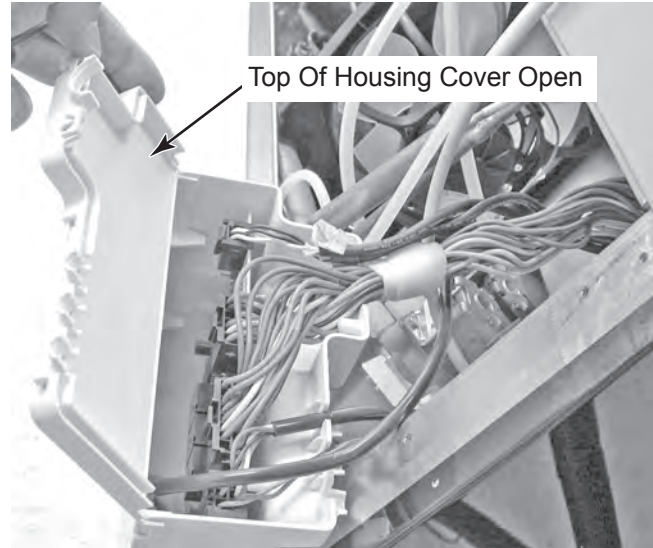

5. Remove the four screws from the control board.
6. Disconnect the wire connectors from the control board and remove it from the housing.

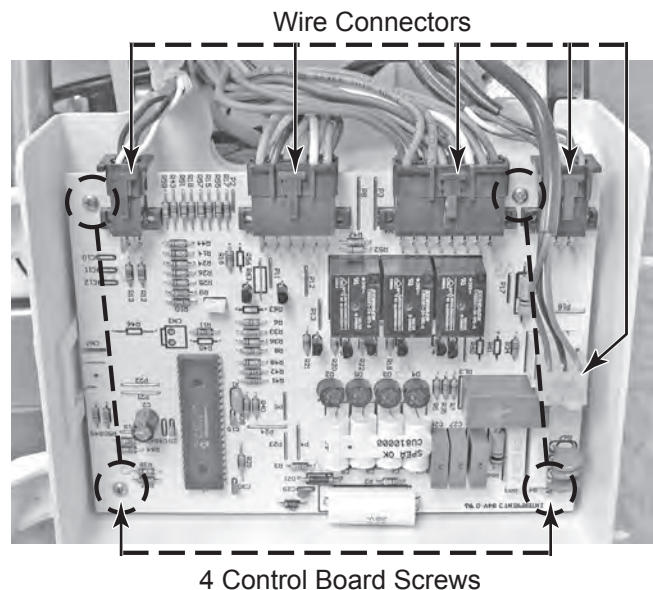

## REMOVING THE WATER VALVES

### **WARNING**



#### **Electrical Shock Hazard**

**Disconnect power before servicing.**

**Replace all parts and panels before operating.**

**Failure to do so can result in death or electrical shock.**

1. Unplug refrigerator or disconnect power.
2. Remove the six screws from the unit compartment cover and remove the cover.

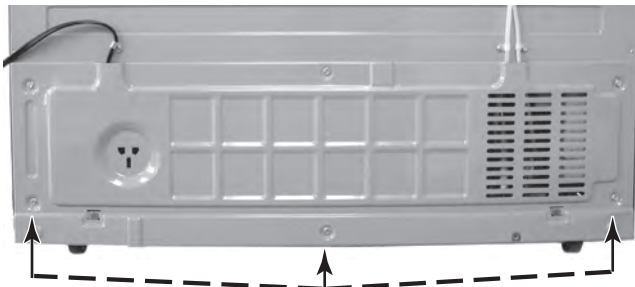

Unit Compartment Cover Screws (3 of 6)

3. Disconnect the two water outlet lines from the water valves.
4. Disconnect the four electrical connectors from the valve terminals. **NOTE:** One valve has 3/16" terminals and the other has 1/4" terminals so that they cannot be reversed.
5. Remove the two 9/32" hex-head screws from the valve bracket.
6. Disconnect the two water inlet lines from the water valves and remove the valve assembly from the unit.

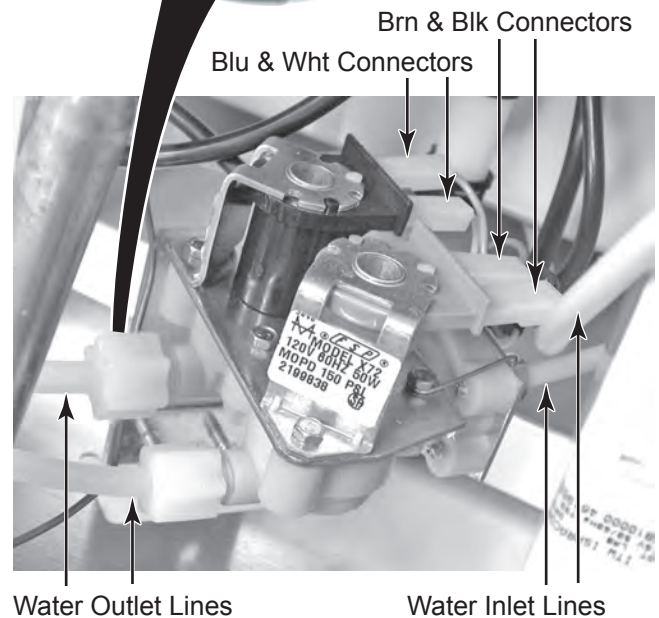

## REMOVING THE CONDENSER FAN MOTOR

### **⚠ WARNING**



#### **Electrical Shock Hazard**

**Disconnect power before servicing.**

**Replace all parts and panels before operating.**

**Failure to do so can result in death or electrical shock.**

1. Unplug refrigerator or disconnect power.
2. Remove the six screws from the unit compartment cover and remove the cover.



Unit Compartment Cover Screws (3 of 6)

3. Using a 9/16" socket, remove the hex-nut and fan blade from the condenser fan motor.

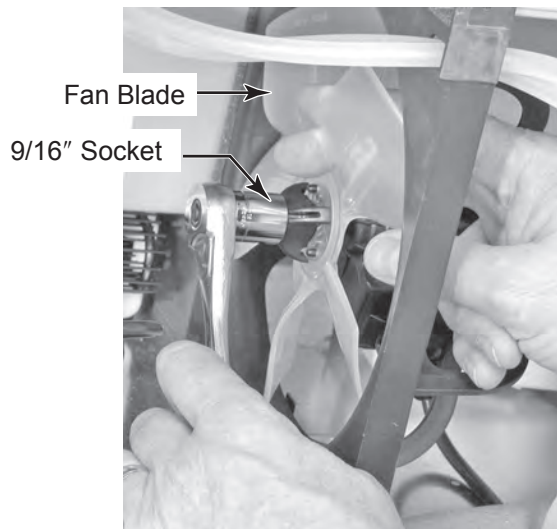

4. Remove the three Torx (#15) screws from the condenser fan motor and remove the motor from the bracket.

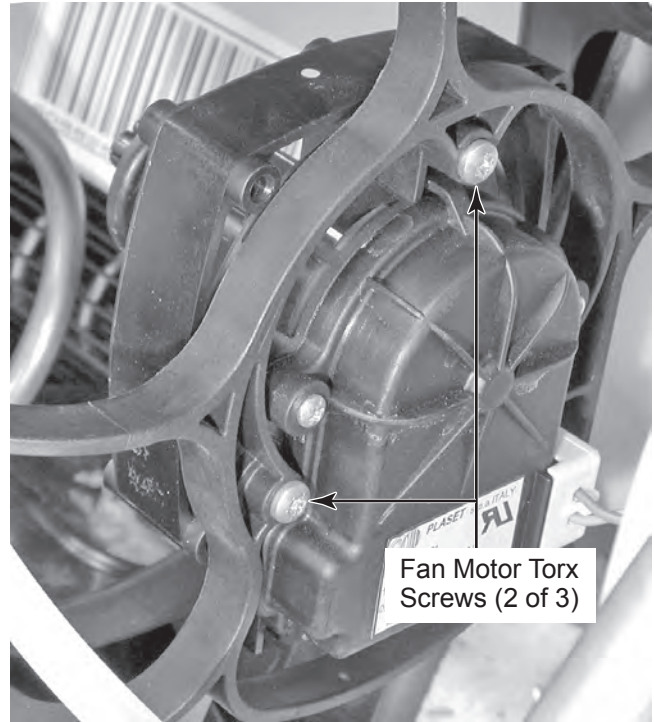

5. Disconnect the wire connector from the fan motor.

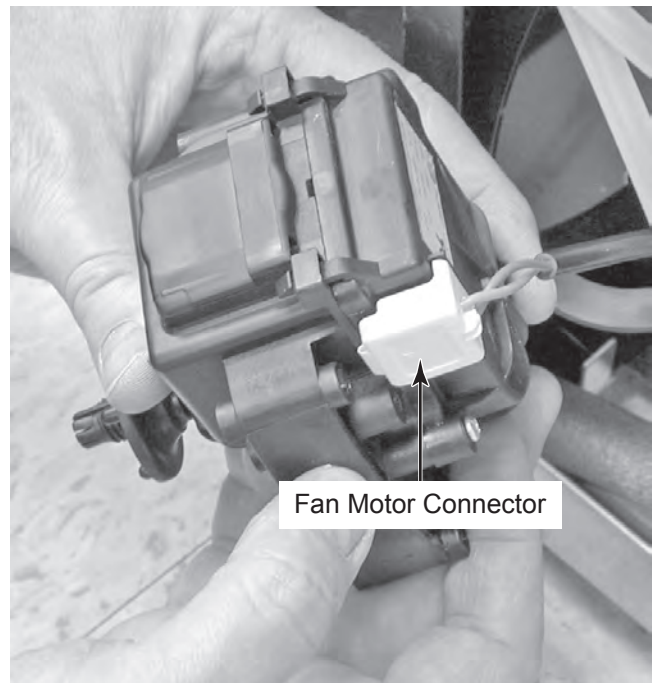



# REMOVING THE COMPRESSOR TERMINAL BOX, THE RELAY & OVERLOAD AND RUN CAPACITOR

## **⚠ WARNING**



### **Electrical Shock Hazard**

**Disconnect power before servicing.**

**Replace all parts and panels before operating.**

**Failure to do so can result in death or electrical shock.**

1. Unplug refrigerator or disconnect power.
2. Remove the six screws from the unit compartment cover and remove the cover.



Unit Compartment Cover Screws (3 of 6)

3. Place a screwdriver blade into the indicated slot of the compressor terminal box cover, and pry the cover off the box.

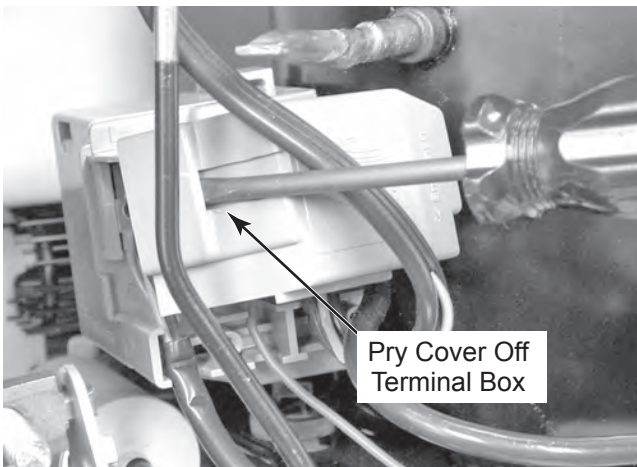

4. To remove the compressor terminal box:

- a) Use a screwdriver and pry the top of the terminal box away from the compressor.



- b) Use a screwdriver and unsnap the locking tab at the lower front of the compressor, then pull the box away from the compressor so that you can access the relay and overload.

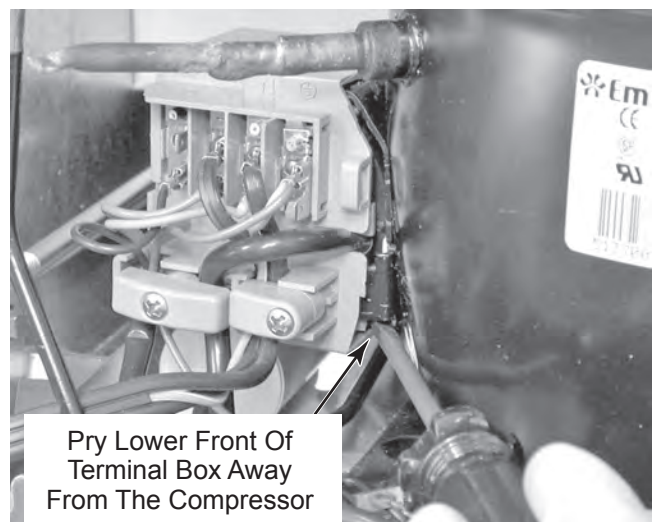

**Continued on the next page.**

5. To remove the relay and overload:

- a) Remove the terminal box from the compressor (see step 4 for the procedure).
- b) Pry the relay off the top two pins of the compressor.
- c) Pry the overload off the bottom pin of the compressor.

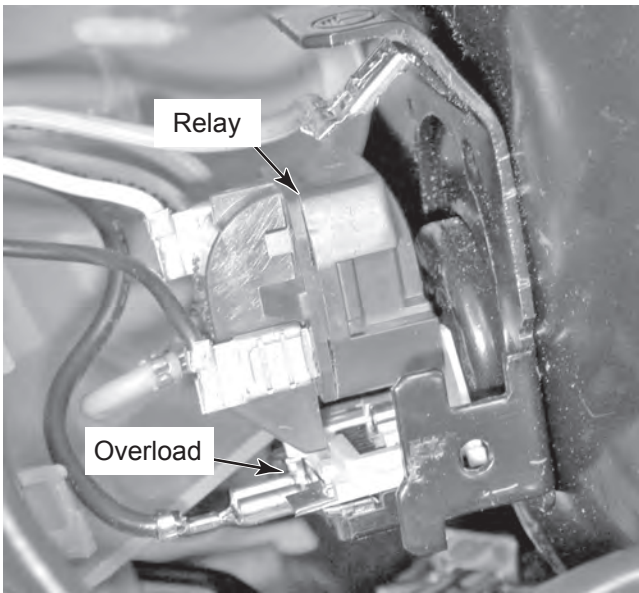

- d) Disconnect the white (1), blue (2), and black (3) wires from the relay terminals.
- NOTE:** The terminal numbers are embossed on the connector.
- e) Disconnect the black wire from the overload terminal.

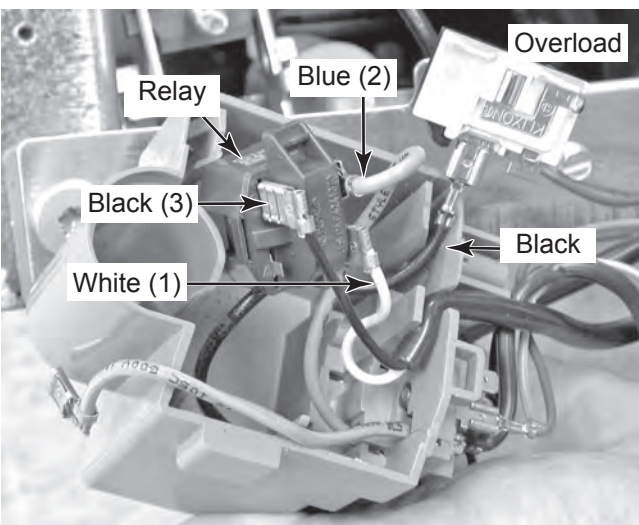

6. To remove the run capacitor:

- a) Remove the terminal box from the compressor (see step 4 for the procedure).
- b) Use a 1/2" socket and remove the run capacitor nut from the bracket.

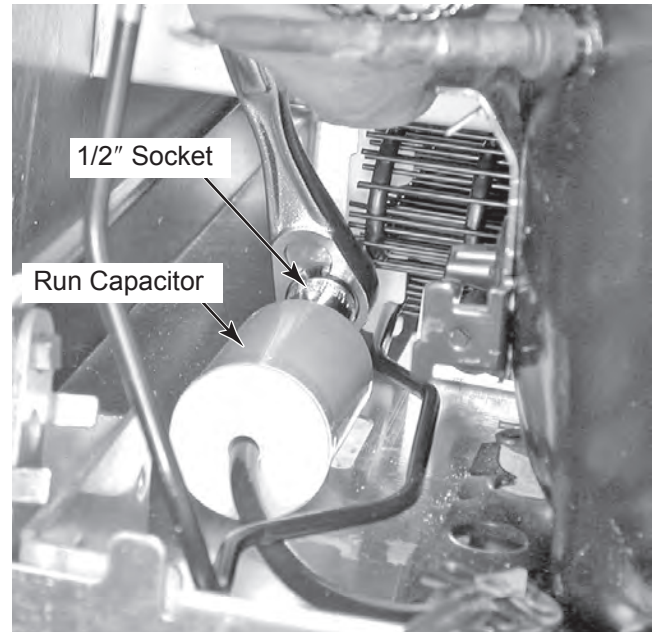

- c) Disconnect the white (1) and black (3) wires from the relay terminals (see the photo at the bottom left).
- d) Loosen the screw from the left strain relief and remove the wire and run capacitor.

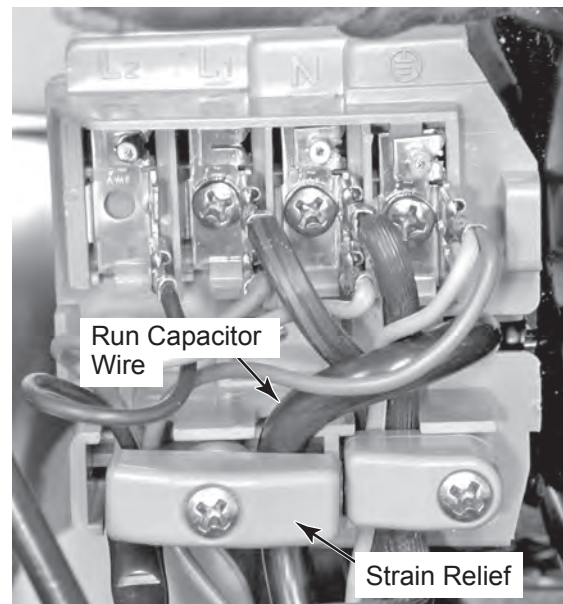

# COMPONENT TESTING

	⚠ WARNING
	<p><b>Electrical Shock Hazard</b></p> <p><b>Disconnect power before servicing.</b></p> <p><b>Replace all parts and panels before operating.</b></p> <p><b>Failure to do so can result in death or electrical shock.</b></p>

The chart below lists all major electrical components and the procedure for checking them. All continuity/resistance checks should be done with harness connectors unplugged.

## COMPONENT TESTING CHART

COMPONENT	VOLTAGE AT COMPONENT	RESISTANCE / WATTS	TEST LOCATIONS
Compressor: Run Windings Start Windings	120 VAC	Compressor pins: 1 to 5 $\Omega$ 3 to 11 $\Omega$	See Tech-Sheet Performance Data Chart.
Start Relay	120 VAC	Continuity	Terminals "S" and "R"
Overload Protector	120 VAC	Continuity	Between terminals.
Run Capacitor	120 VAC	Momentary resistance	Check at capacitor; reverse test leads and check again.
Electric Air Baffle (Motor)	120 VAC	Approx. 8450 $\Omega$ , 1.5 Watts	Check resistance at Control Board terminals 16/4 & 12/7. During nor- mal operation, 120V is present at Baffle termi- nals 1 & 2.
Thermistors: RC Side FC Side	Low voltage; cannot measure	2700 $\Omega$ at 77°F (25°C) 8750 $\Omega$ at 32°F (0°C)	RC thermistor at Control Board pins 4/1 & 4/3. FC thermistor at Control Board pins 4/2 & 4/4.

**Continued on the next page.**

COMPONENT	VOLTAGE AT COMPONENT	RESISTANCE / WATTS	TEST LOCATIONS									
Electronic Control Board	120 VAC	N/A	Will have 120V at Control Board terminals 3 & 2.									
User Interface Board	120 VAC	N/A	Will have 120V at User Interface pins 5/3 & 5/1.									
Defrost Bimetal	120 VAC	Opens @ 45°F±5° (7°C±3°) Closes @ 19°F±5° (-7°C±3°)	Check for continuity.									
Thermofuse	120 VAC	Opens @ 162°F (72°C)										
Defrost Heater	120 VAC	550 to 650 Watts 27 to 21 Ω	Check resistance at Control Board terminals 16/1 & 12/1 or at heater.									
Evaporator Fan Motor	120 VAC	3 Watts	Cannot read resistance/ 120 VAC converted to DC voltage in the motor.									
Condenser Fan Motor	120 VAC	5 Watts	Cannot read resistance/ 120 VAC converted to DC voltage in the motor.									
Ice Dispenser Motor	120 VAC	N/A	Will have 115 VDC at Dispenser Motor terminals 1 & 5. DC polarity determines the rotation of the motor: <table border="1" style="margin-left: auto; margin-right: auto;"> <tr> <td>Terminal</td> <td>1</td> <td>5</td> </tr> <tr> <td>Crushed:</td> <td>-</td> <td>+</td> </tr> <tr> <td>Cube:</td> <td>+</td> <td>-</td> </tr> </table>	Terminal	1	5	Crushed:	-	+	Cube:	+	-
Terminal	1	5										
Crushed:	-	+										
Cube:	+	-										

# DIAGNOSTICS & TROUBLESHOOTING



## **! WARNING**

### **Electrical Shock Hazard**

**Disconnect power before servicing.**

**Replace all parts and panels before operating.**

**Failure to do so can result in death or electrical shock.**

Diagnostics on this product are different than on other Whirlpool SxS refrigerators. Several error codes are available, however there is no “diagnostic mode” that can be “entered” on the electronic control to allow operation of each function separately.

Virtually all functional component testing must be performed similarly to a non-electronic product by verifying whether the component is “good,” or whether there is voltage present at the component. To know how these components function in this product, refer to the “Theory of Operation” section and the contents of this section.

## **IMPORTANT INFORMATION**

### **Electronic Control Board**

- Virtually all components and functions are electrically connected to and controlled by the Electronic Control Board both on the “line” and “neutral” side. The exception is the ice dispenser motor and the dispenser light. These components are directly connected to and controlled by the User Interface.

- The majority of components and functions controlled by the Electronic Control Board are switched on the “neutral” side of the circuit. This means the “line” side of the circuit to the component(s) always has voltage potential.

### **User Interface Control Board**

- The User Interface Control Board is also energized by “line” and “neutral” circuits through the Electronic Control Board. Communication between the two boards is through the “TX” and “RX” circuits (refer to the Wiring Diagram and Strip Circuit).
- Turning OFF the refrigerator turns off all of the interior and indicator lights except two dots (“.”) in the temperature displays.

## **SUGGESTIONS ON DIAGNOSIS**

### **IMPORTANT:**

1. Check harness connectors for good contact.
2. Before replacing any component verify, whenever possible, that the component has proper continuity or resistance values. There must be proper power to operate the component.

### **Display Shows Error Codes**

- If error codes “C”, “d” or “CF” show in the display, refer to the “User Interface Failure Feedback” and “Component Testing” charts and check out the appropriate component(s).

### **Display Is Normal**

- Disconnect power for 10 seconds and re-connect power. If error code is displayed after 3 minutes, refer to the “User Interface Failure Feedback” and “Component Testing” charts, and check out the appropriate component(s).
- If no error codes display and a malfunction is occurring, check or troubleshoot the following appropriate areas. Also refer to the “Component Testing” and “Troubleshooting” charts.
  - Electrical system
  - Restricted or lack of proper airflow
  - Defrost system
  - Unusual noises
  - Cooling system

### **Display Is Blank**

- Refer to “User Interface Failure Feedback” and “Troubleshooting” charts.

# USER INTERFACE FAILURE FEEDBACK

The User Interface can display several failure codes. The display will only show the code(s) for 10 minutes, then revert back to the set temperature(s). To access these codes again, disconnect power to the refrigerator for 10 seconds and then power it up again. It may take 3 minutes for the error code(s) to display. The following table summarizes these codes.

	<b>! WARNING</b>
	<p><b>Electrical Shock Hazard</b></p> <p><b>Disconnect power before servicing.</b></p> <p><b>Replace all parts and panels before operating.</b></p> <p><b>Failure to do so can result in death or electrical shock.</b></p>

FAILURE	POSSIBLE CAUSE	TEST PROCEDURE—ACTION
No lights inside the refrigerator. No display indicators except “.” dots in both temperature displays.	The refrigerator is OFF.	Press the ON/OFF keypad for two seconds to turn the unit ON.
No indicators illuminate on user interface. Unit may or may not be cooling.	No power to the user interface from the control board.	Unplug refrigerator or disconnect power. Check circuits/connectors from control board to user interface. Attempt to turn ON unit by pressing the ON/OFF keypad. If unit is cooling, control board is in default mode. If unit is not cooling, unit may be OFF with no way to turn it ON. Refer to the “Troubleshooting Chart.”
Code “d” blinking on the refrigerator display.	Air door stuck or open circuit.	Perform resistance checks (refer to “Component Testing” section). Verify the proper wire connections to the air door motor and control board. Refer to “Component Testing,” page 5-1, and “Strip Circuits,” page 7-3. Replace the air door.
Code “C” blinking on the refrigerator display.	Refrigerator thermistor failure.	Perform resistance checks (refer to “Component Testing” section). Verify the proper connections to the main board and the resistance value of the thermistor. Replace the main board.
Code “C” blinking on the freezer display.	Freezer thermistor failure.	Perform resistance checks (refer to “Component Testing” section). Verify the proper connections to the main board and the resistance value of the thermistor. Replace the main board.

**Continued on the next page.**

FAILURE	POSSIBLE CAUSE	TEST PROCEDURE—ACTION
Code “CF” blinking on the freezer display.	Communication failure between main board and user interface.	Verify the proper connections & circuits for RX and TX. Replace the user interface and if the problem persists, replace the main board.
18°F (–8°C) or higher temperature reading is blinking on the freezer display.	Over-temperature condition due to power failure.	Verify proper main plug connection. Press the freezer temperature keypad to reset.



# TROUBLESHOOTING CHART

The following table shows the various types of appliance faults:

	<h2 style="margin: 0;">⚠ WARNING</h2>
<p><b>Electrical Shock Hazard</b></p> <p><b>Disconnect power before servicing.</b></p> <p><b>Replace all parts and panels before operating.</b></p> <p><b>Failure to do so can result in death or electrical shock.</b></p>	

PROBLEM	POSSIBLE CAUSE	TEST PROCEDURE—ACTION
No indicators or functions on user interface.	No power supply.	Verify circuits RX and TX. Verify proper wire connections from main board pins 12/11 & 12/12, to user interface pins 3/1 & 3/2. Refer to wiring diagram. Replace the user interface.
Indicators for set temperatures display correctly, but dispenser light is dim when turned on, and ice will not dispense.	Open neutral circuit to user interface.	Check for proper wiring and connections of neutral circuit from control board (pin 12/10) to user interface (pin 5/1).
No water when dispenser lever is pressed.	Microswitch or water valve failure.	Verify proper wire connections to microswitch at main board pins 6/3 & 16/9. Verify water valve connections at main board pins 6/2 and 6/5. Refer to “Component Testing” section & “Strip Circuits.” Replace the control board.
No ice dispensed when dispenser lever is pressed.	Microswitch or ice motor failure.	Verify proper wire connections to microswitch at user interface board pins 3/3 & 5/3. Verify ice motor connections at user interface board pins 5/4 and 5/5. Refer to “Component Testing” section & “Strip Circuits.” Replace the user interface.
Refrigerator compartment light does not switch on when door is opened.	Burned out lamp. Loose wiring connections. Door switch failure.	Verify if the lamp is good. Verify proper operation of refrigerator compartment door switch and connections.
Freezer compartment light does not switch on when door is opened.	Burned out lamp. Loose wiring connections. Door switch failure.	Verify if the lamp is good. Verify proper operation of freezer compartment door switch and connections.

**Continued on the next page.**

PROBLEM	POSSIBLE CAUSE	TEST PROCEDURE—ACTION
Ice maker not producing any ice.	Loose connections. Ice maker failure. IR receiver relay failure. IR receiver and emitter optics failure.	Verify proper wire connections. Refer to the wiring diagram. Refer to the ice maker “Diagnostic & Troubleshooting” section in In-Door Ice Job Aid #4322658A. Replace the IDI electronic boards. <b>NOTE:</b> In-Door Ice infrared electronic boards used in this product are unique to this product. Other IDI boards fit, but will not allow the icemaker to function.
Evaporator fan motor does not run.	Fan motor stuck. Control board may have initiated fan delay. Refrigerator or freezer light switches not closing fan circuit. Loose connection. Control board.	Verify that motor spins freely. Verify that the control board is not in fan delay. Motor rectifies 120 volts AC to DC for operation. Verify both light switches function properly. Verify proper circuit and wire connections back to the control board. Replace the control board.
Condenser fan motor does not run.	Fan motor stuck. Control board may have initiated fan delay. No voltage to fan motor. Loose connection. Control board.	Verify that motor spins freely. Verify that the control board is not in fan delay. Motor rectifies 120 volts AC to DC for operation. Verify proper wire circuit and connections back to the control board. Replace the control board.
Compressor will not run.	Refrigerator turned OFF. Control board may have initiated delay. Overload or relay failure. Loose/open electrical connections. Compressor is stuck. Control board.	Check the compressor for the following: <ul style="list-style-type: none"> <li>• Unplug refrigerator or disconnect power.</li> <li>• Verify that control board is not in compressor start delay mode. (Refer to “Theory of Operation” Section).</li> <li>• Verify proper wire connections.</li> <li>• Voltage to main control board is missing, replace the main control board.</li> <li>• Verify that overload and relay are good. If not, replace.</li> <li>• Verify compressor windings are good, (refer to the Tech Sheet), and that the compressor is not stuck. Replace compressor, if necessary.</li> </ul>

PROBLEM	POSSIBLE CAUSE	TEST PROCEDURE—ACTION
Will not defrost.	Defrost heater. Defrost bimetal / thermofuse. Control board.	<p>Defrost can be initiated by disconnecting and reconnecting power. Main control board will attempt to initiate defrost upon restart:</p> <ul style="list-style-type: none"> <li>• If bimetal is closed, defrost cycle will start. Relay on main control board will click one time.</li> <li>• If bimetal or defrost circuit is open, defrost cycle will not start, and the cooling cycle will begin. Relay on main control board will click twice (once to initiate defrost and the second time to switch back to cooling).</li> </ul> <p>Unplug refrigerator or disconnect power. Refer to “Component Testing” on page 5-2. Check for continuity through heater, bimetal, and thermofuse. Check for loose electrical connections. If all checks out, replace the main control board.</p>
Refrigerator too cold or too warm.	Air door may be stuck or frozen open. User interface may be malfunctioning.	<p>Check air door operation. Unplug refrigerator or disconnect power. Check resistance of refrigerator thermistor. Replace user interface.</p>

# ELECTRONIC CONTROL BOARD PIN LOCATIONS

## 3 PIN CONNECTOR (Control Board)

- Pin 1 Line
- Pin 2 Compressor Command (Line)
- Pin 3 Neutral

## 6 PIN CONNECTOR (Control Board)

- Pin 1 Ice Maker Ice Valve Return (Line)
- Pin 2 Water Valve Feedback (Line)
- Pin 3 Condenser Fan Line (Line)
- Pin 4 Ice Maker Ice Valve Neutral (Neutral)
- Pin 5 Water Valve Neutral (Neutral)
- Pin 6 Condenser Fan Load (Neutral)

## 16 PIN CONNECTOR (Control Board)

- Pin 1 Freezer Line
- Pin 2 Door Line
- Pin 3 Receiver IDI Line
- Pin 4 Air Door Line
- Pin 5 Lamps Line
- Pin 6 Freezer Lamp Feedback (Line)
- Pin 7 Refrigerator Lamp Feedback (Line)
- Pin 8 Ice Maker Ice Valve Return (Line)
- Pin 9 Water Valve Feedback (Line)
- Pin 10 N.C.
- Pin 11 Emitter IDI Neutral (Neutral)

- Pin 12 Freezer Lamp Load (Neutral)
- Pin 13 Refrigerator Lamp Load (Neutral)
- Pin 14 Defrost Heater (Neutral)
- Pin 15 Ice Maker Load (Neutral)
- Pin 16 Receiver IDI Load (Neutral)

## 12 PIN CONNECTOR (Control Board)

- Pin 1 Bimetal Feedback (Neutral)
- Pin 2 N.C.
- Pin 3 Freezer Lamp Feedback x Receiver IDI (Line)
- Pin 4 N.C.
- Pin 5 Air Door Feedback (Line)
- Pin 6 Emitter IDI Line (Line)
- Pin 7 Air Door Load (Neutral)
- Pin 8 Evaporator Fan Load (Neutral)
- Pin 9 N.C. (Neutral)
- Pin 10 Door Neutral (Neutral)
- Pin 11 Door RX (Signal)
- Pin 12 Door TX (Signal)

## 4 PIN CONNECTOR (Control Board)

- Pin 1 Refrig. Therm. Common (Signal)
- Pin 2 Freezer Therm. Common (Signal)
- Pin 3 Refrig. Therm. (Signal)
- Pin 4 Freezer Therm. (Signal)

**NOTE:** Refrigerator thermistor wires are marked with red tape.

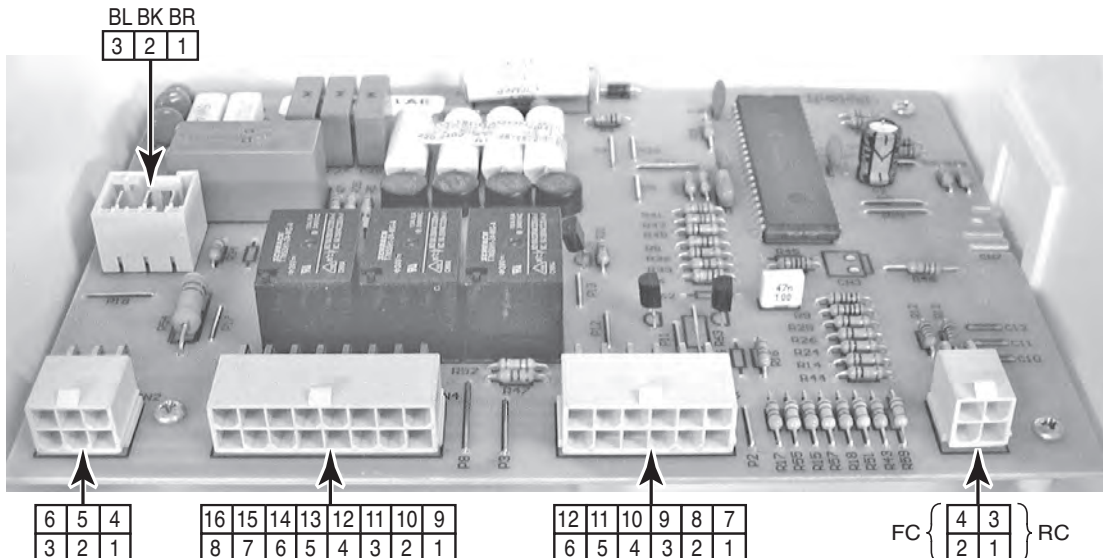

# USER INTERFACE BOARD PIN LOCATIONS

## 5 PIN CONNECTOR (User Interface)

- Pin 1 Neutral
- Pin 2 Dispenser Lamp Load (Neutral)
- Pin 3 Line
- Pin 4 DC Ice Motor
- Pin 5 DC Ice Motor

## 3 PIN CONNECTOR (User Interface)

- Pin 1 Door TX (Signal)
- Pin 2 Door RX (Signal)
- Pin 3 DC Ice Motor Power Supply (Line)

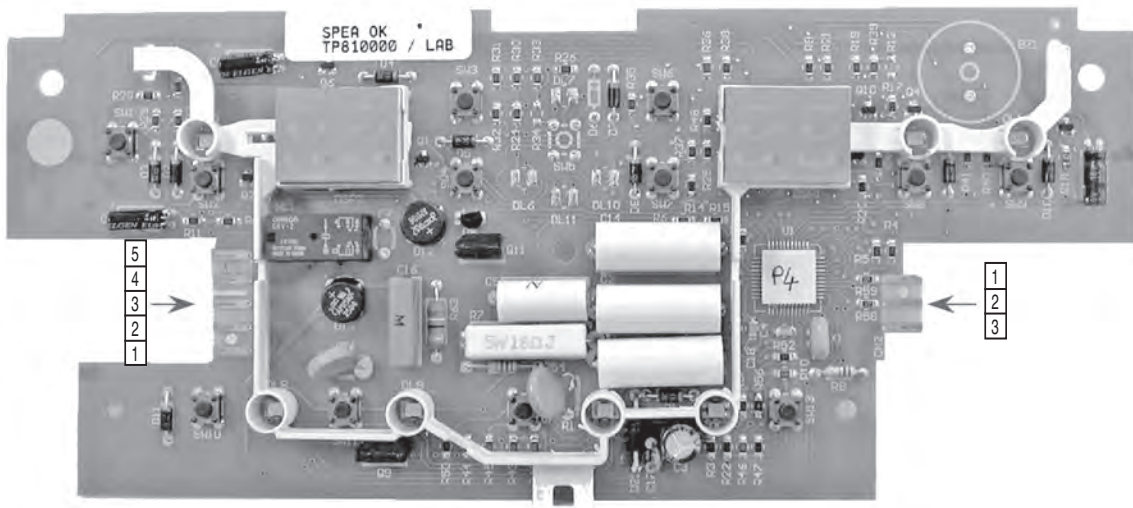

# THERMISTOR RESISTANCE / TEMPERATURE CHART

Temperature °F	Temperature °C	Resistance (Ohm)
77.0	25	2700
50.0	10	5348
45.0	7	6033
40.0	4	6989
35.0	2	7916
* 32.0	0	8750
30.2	-1	9216
25.0	-4	10483
20.0	-7	12269
15.0	-9	14019
10.0	-12	16497
5.0	-15	19474
0	-18	22417
-5.0	-21	27402
-10.0	-23	31717
-15.0	-26	37922
-20.0	-29	44130
-25.0	-32	53111
-30.0	-34	62155

\* To accurately check a thermistor, place it in ice water for 60 seconds, then measure its resistance.

— NOTES —

# WIRING DIAGRAM & STRIP CIRCUITS

## WIRING DIAGRAM

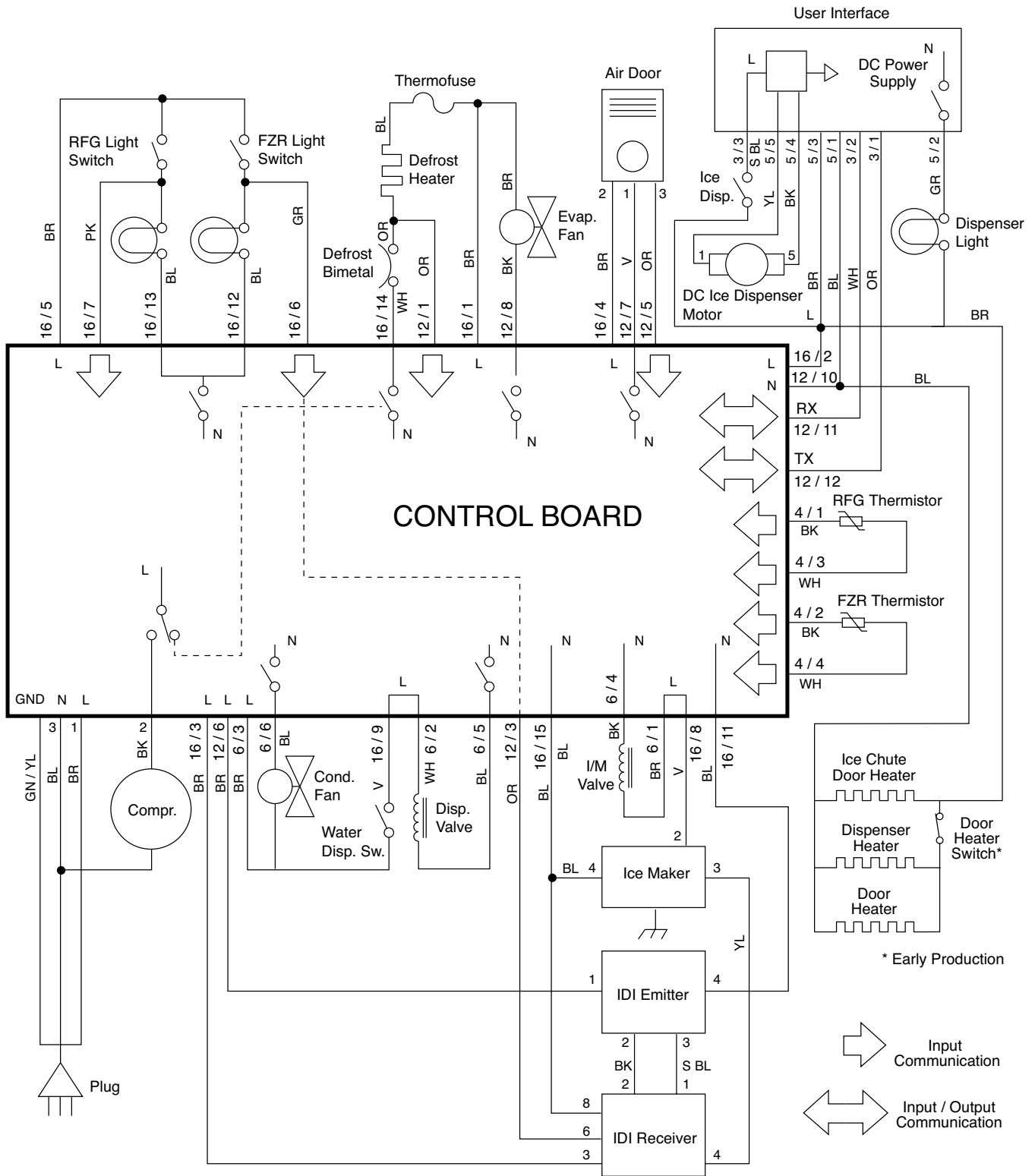

# STRIP CIRCUITS

## COMPRESSOR

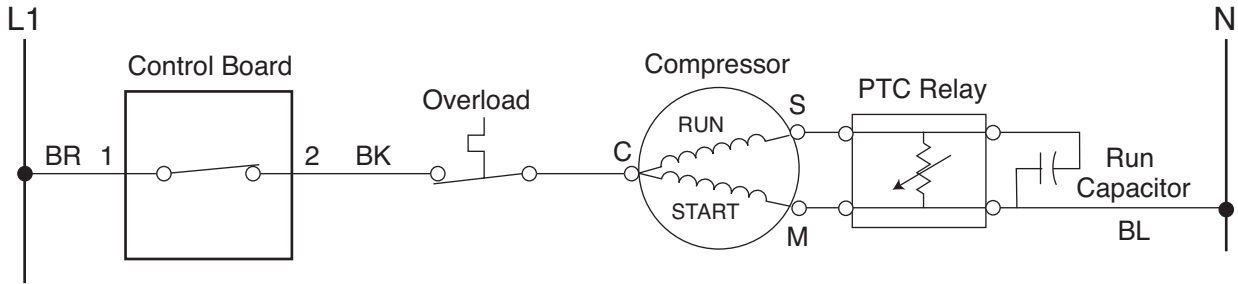

## CONDENSER FAN MOTOR

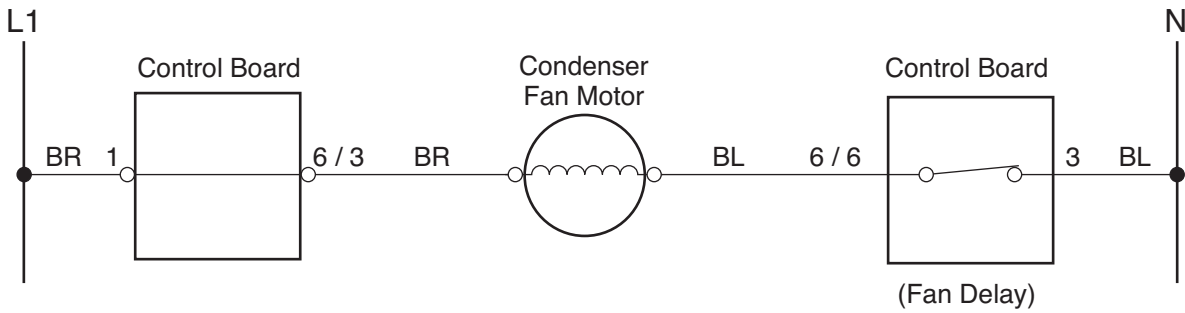

## DEFROST

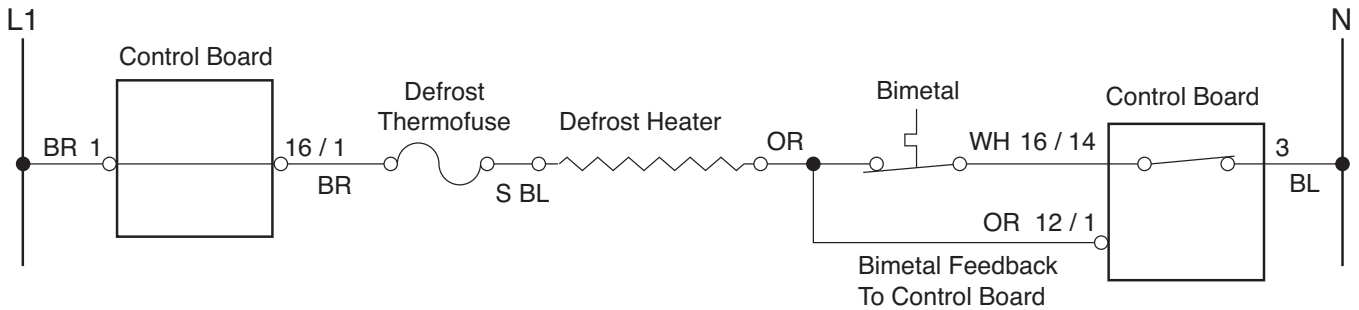

## EVAPORATOR FAN / DELAY

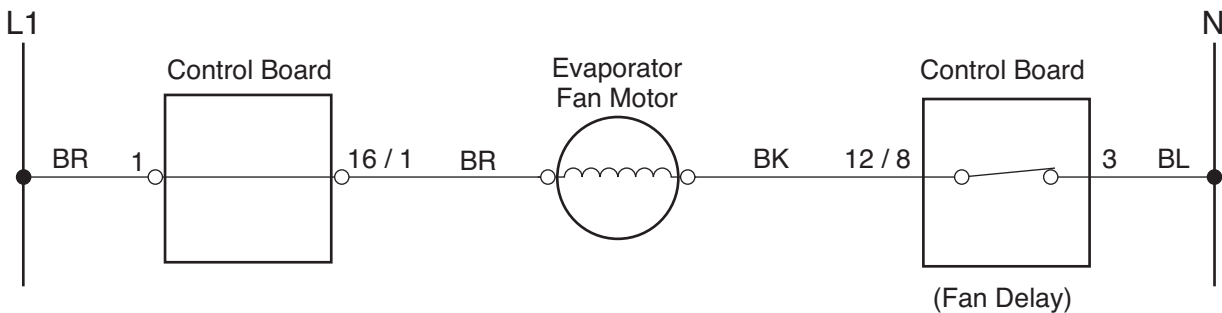



## DAMPER (AIR DOOR MOTOR)

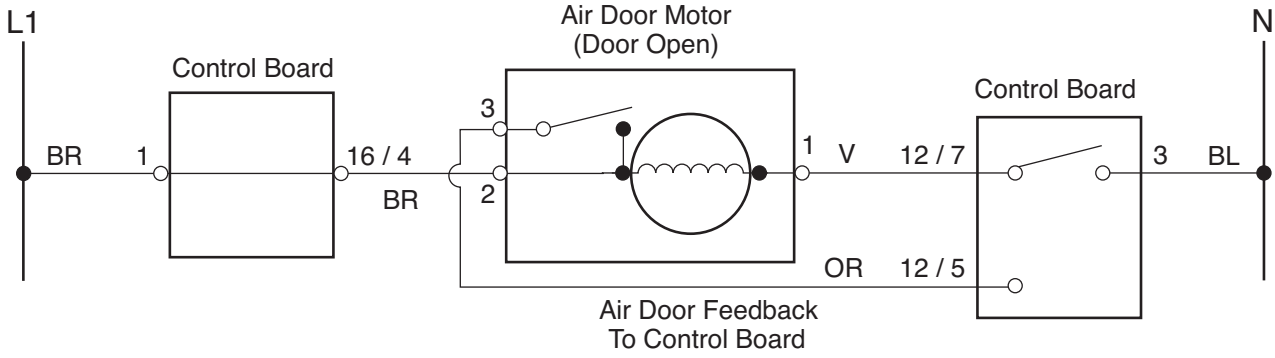

## REFRIGERATOR LIGHT

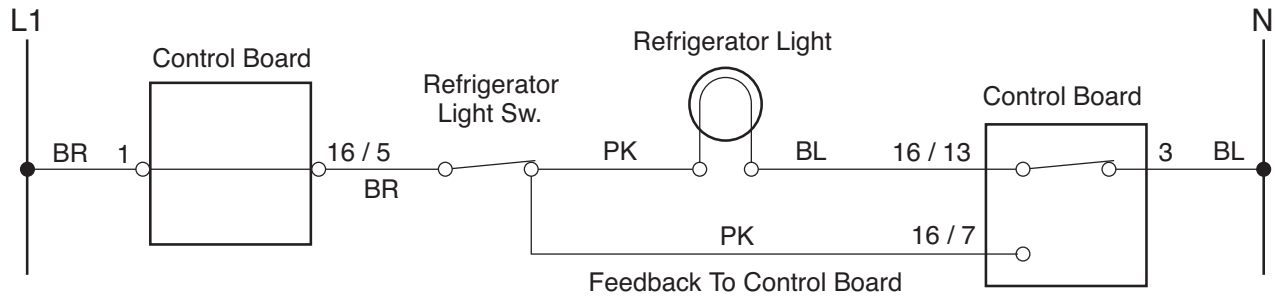

## FREEZER LIGHT

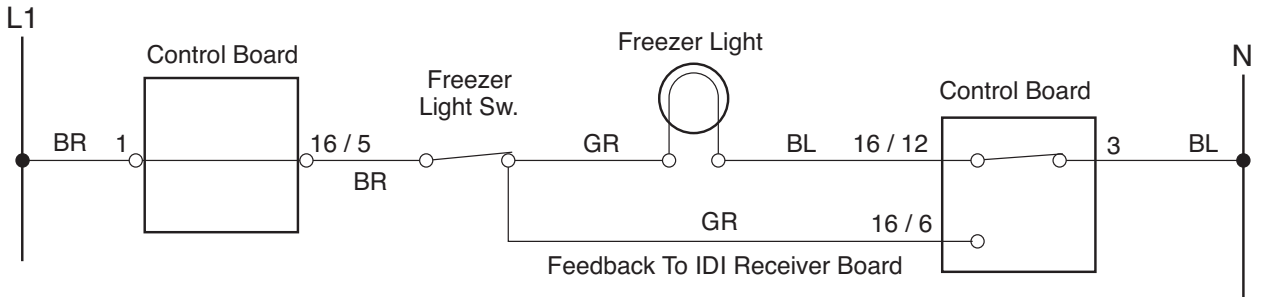

## DISPENSER LIGHT

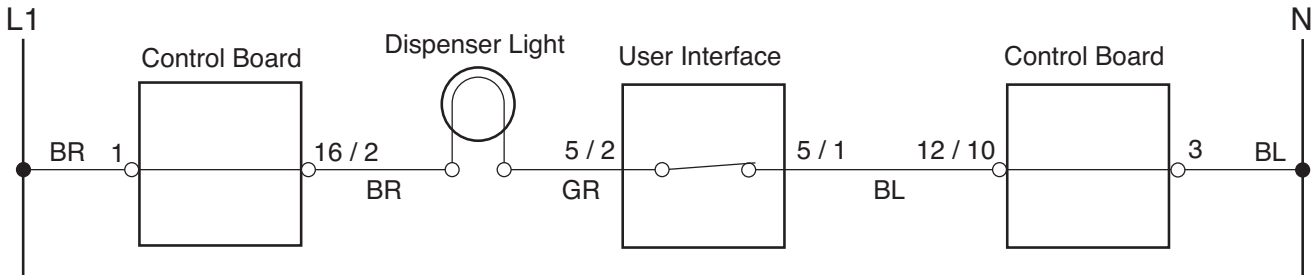

## WATER DISPENSER

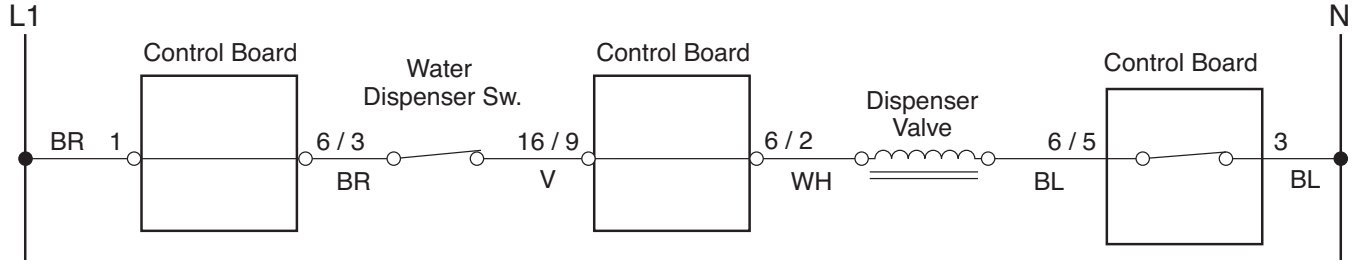

## ICE DISPENSER

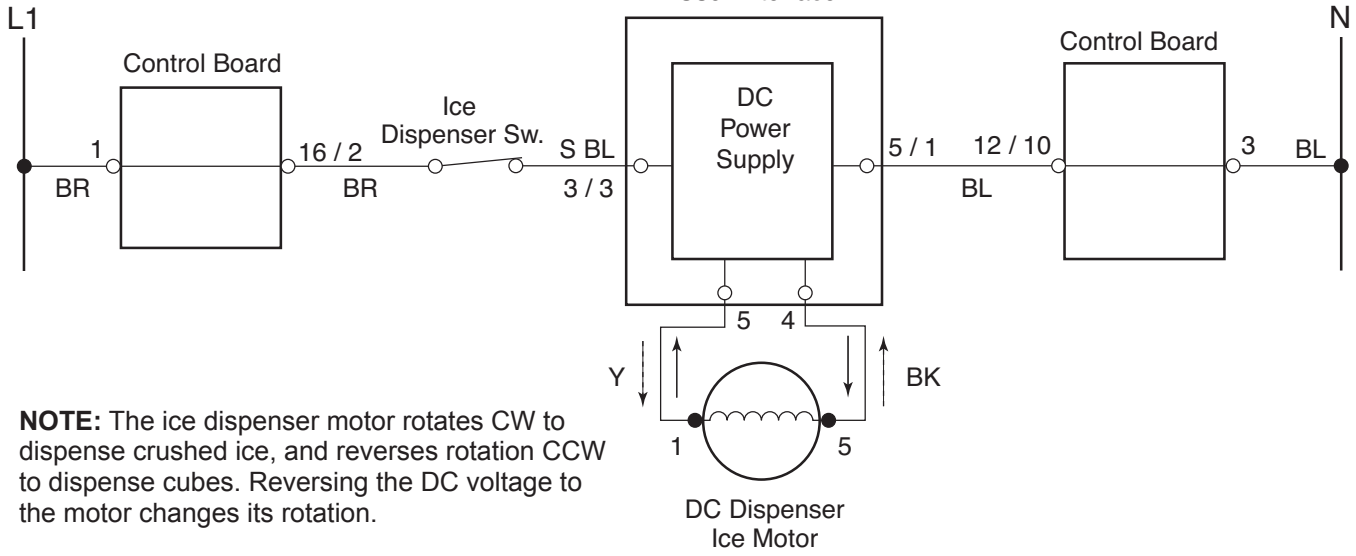

## ICE CHUTE DOOR HEATER

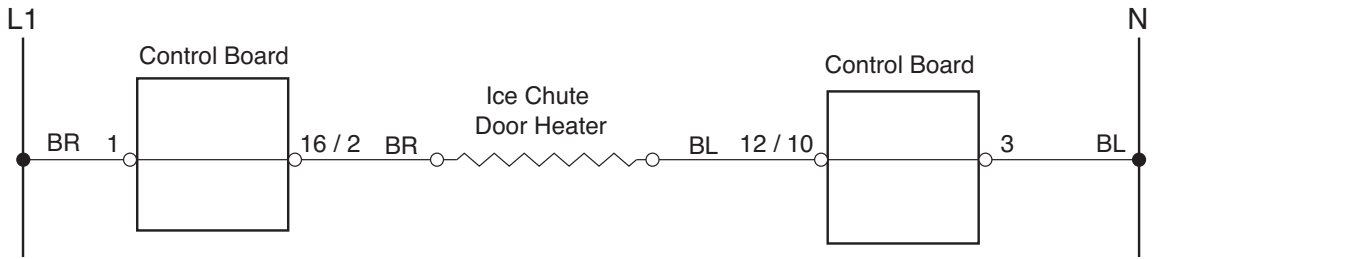

## FREEZER DOOR & DISPENSER HOUSING HEATERS

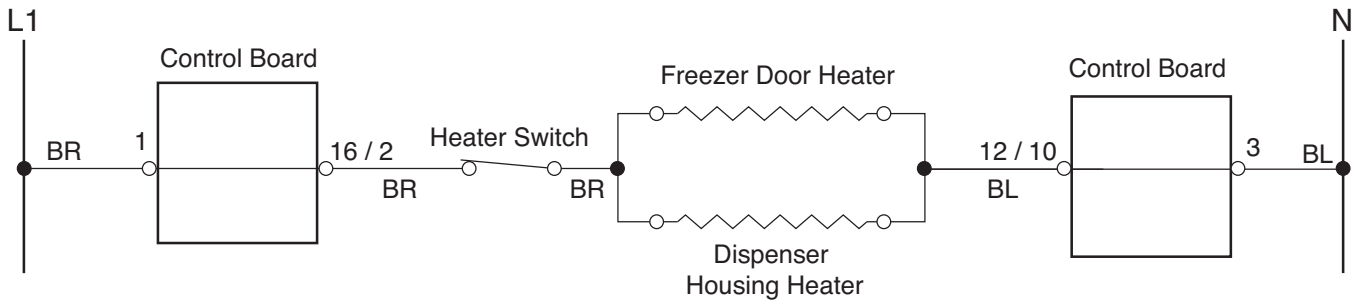

## IDI ICE MAKER

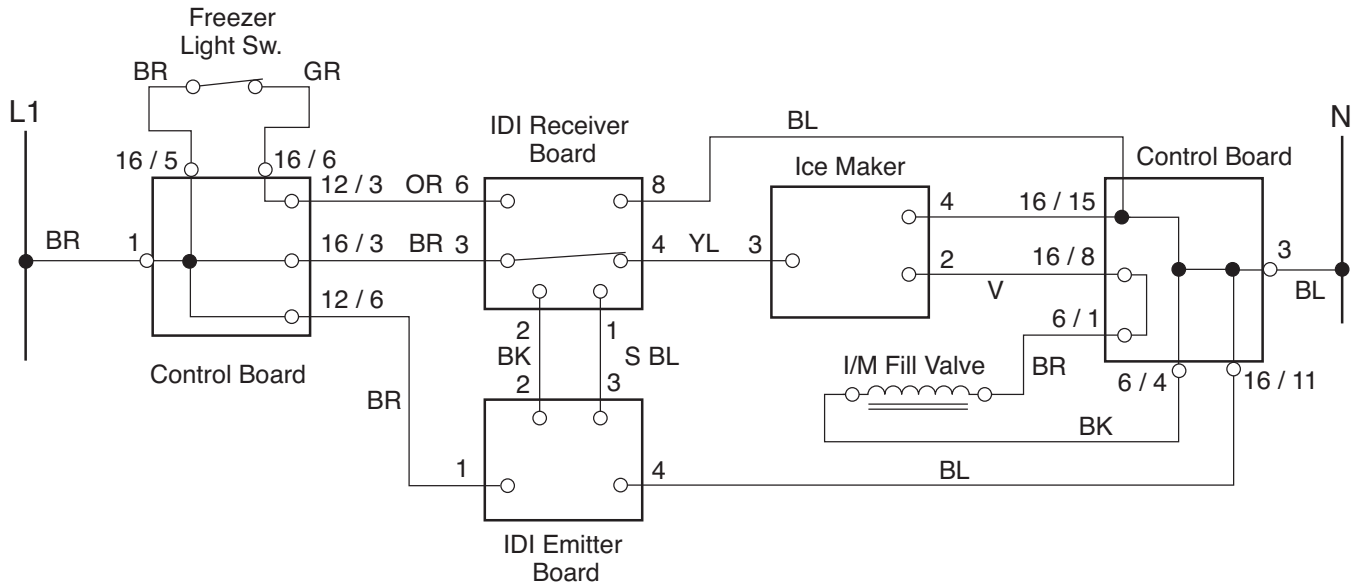

## THERMISTORS

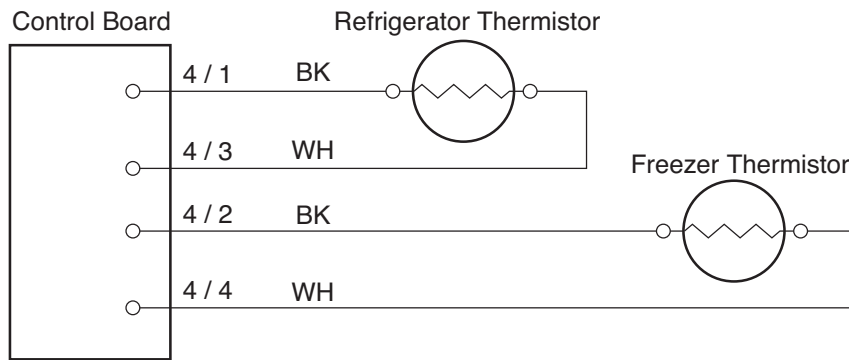

## POWER & COMMUNICATIONS CIRCUITS BETWEEN BOARDS

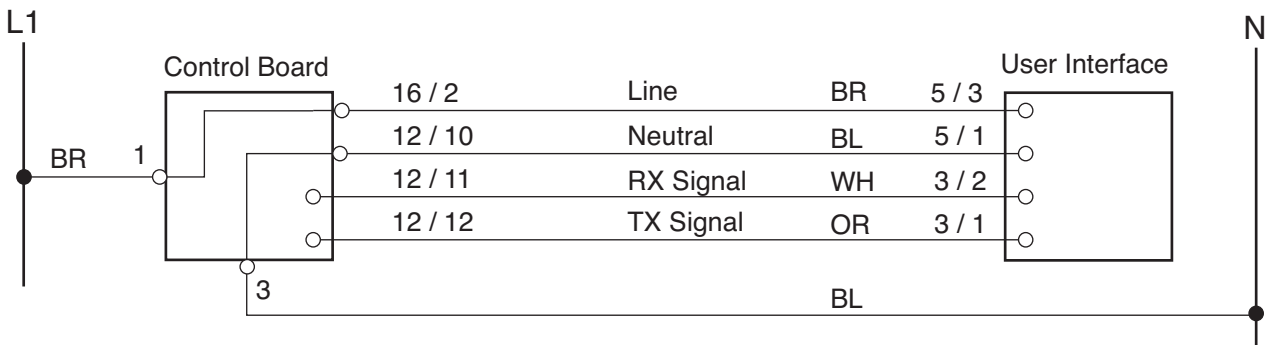

— NOTES —

# TECH TIPS

## REMOVING THE ORIGINAL GASKET

**NOTE:** Replacing the gasket requires trimming away only the soft part of the original foamed-in-place (FIP) gasket. Once the soft part of the FIP gasket is removed, a channel is exposed to install the service gasket.

To remove the original door gasket:

1. Cut the soft corner section of the FIP gasket.



2. Trim the soft part of the gasket with a knife around all four sides to expose the channel where the service gasket will be mounted.



3. Clean the remaining soft gasket burr from all sides of the door.

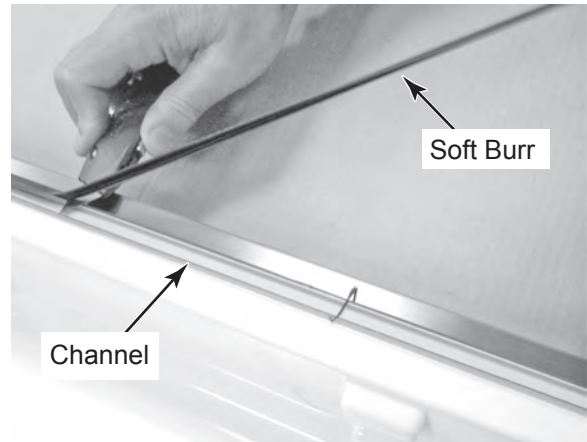

4. Clean the FIP gasket corner from the flash and burr that was created when the gasket was manufactured. The service gasket may now be installed.

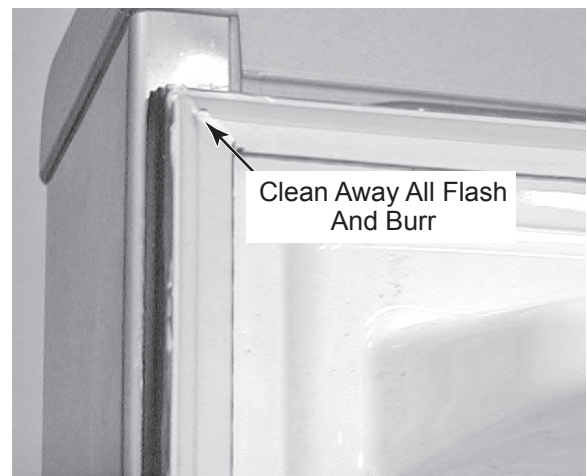

## INSTALLING THE SERVICE GASKET

1. Insert the service gasket into the rigid foamed gasket channel.



Channel In  
FIP Gasket

Insert Gasket Into Rigid  
Foamed Gasket Channel

2. Seat the service gasket securely into the rigid foamed gasket channel with a mallet.

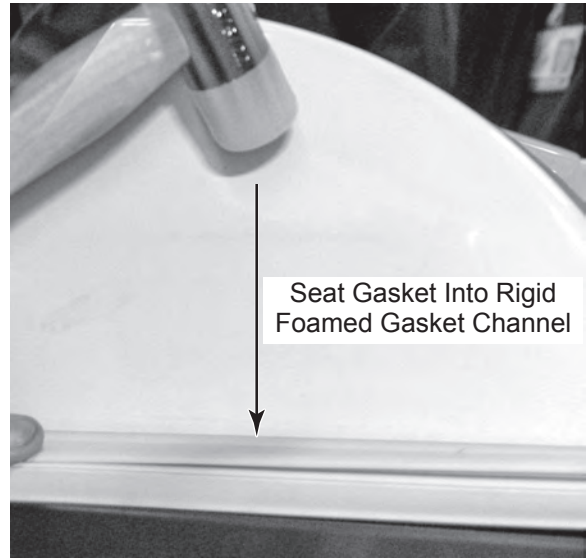

Seat Gasket Into Rigid  
Foamed Gasket Channel

# **PRODUCT SPECIFICATIONS AND WARRANTY INFORMATION SOURCES**

***IN THE UNITED STATES:***

**FOR PRODUCT SPECIFICATIONS AND WARRANTY INFORMATION CALL:**

**FOR WHIRLPOOL PRODUCTS: 1-800-253-1301**

**FOR KITCHENAID PRODUCTS: 1-800-422-1230**

**FOR ROPER PRODUCTS: 1-800-447-6737**

**FOR TECHNICAL ASSISTANCE WHILE AT THE CUSTOMER'S HOME CALL:**

**THE TECHNICAL ASSISTANCE LINE: 1-800-253-2870**

**HAVE YOUR STORE NUMBER READY TO IDENTIFY YOU AS AN  
AUTHORIZED SERVICER**

**FOR LITERATURE ORDERS:**

**PHONE: 1-800-851-4605**

**FOR TECHNICAL INFORMATION AND SERVICE POINTERS:**

**[www.servicematters.com](http://www.servicematters.com)**

---

***IN CANADA:***

**FOR PRODUCT SPECIFICATIONS AND WARRANTY INFORMATION CALL:**

**1-800-461-5681**

**FOR TECHNICAL ASSISTANCE WHILE AT THE CUSTOMER'S HOME CALL:**

**THE TECHNICAL ASSISTANCE LINE: 1-800-488-4791**

**HAVE YOUR STORE NUMBER READY TO IDENTIFY YOU AS AN  
AUTHORIZED SERVICER**

