



CONSUMER CARE TECHNICAL
EDUCATION GROUP PRESENTS

L-83

**2008
24" FRONT-LOADING
AUTOMATIC WASHER**



Model WFC7500VW0

**JOB AID
Part No. 8178738**

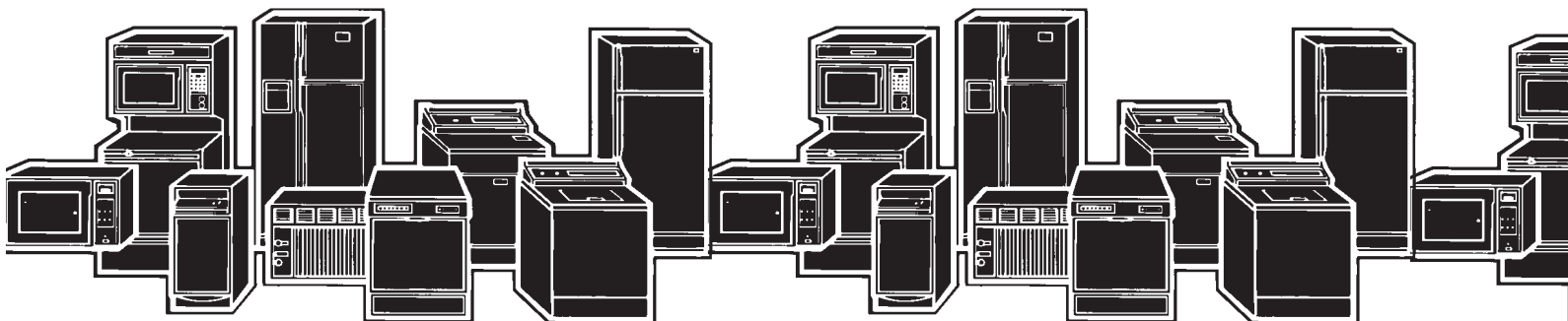

FORWARD

This Whirlpool Job Aid, "2008 24" Front-Loading Automatic Washer" (Part No. 8178738), provides the In-Home Service Professional with information on the installation, operation, and service of the 2008 24" Front-Loading Automatic Washer. For specific information on the model being serviced, refer to the "Use and Care Guide," or "Tech Sheet" provided with the washer.

The Wiring Diagram used in this Job Aid is typical and should be used for training purposes only. Always use the Wiring Diagram supplied with the product when servicing the unit.

GOALS AND OBJECTIVES

The goal of this Job Aid is to provide information that will enable the In-Home Service Professional to properly diagnose malfunctions and repair the 2008 24" Front-Loading Automatic Washer.

The objectives of this Job Aid are to:

- Understand and follow proper safety precautions.
- Successfully troubleshoot and diagnose malfunctions.
- Successfully perform necessary repairs.
- Successfully return the washer to its proper operational status.

WHIRLPOOL CORPORATION assumes no responsibility for any repairs made on our products by anyone other than In-Home Service Professionals.

TABLE OF CONTENTS

	Page
GENERAL	1-1
Washer Safety	1-1
Model & Serial Number Designations	1-2
Model & Serial Number Label And Tech Sheet Locations	1-3
Specifications	1-4
INSTALLATION INFORMATION	2-1
Installation Requirements	2-1
Installation Instructions	2-6
PRODUCT OPERATION	3-1
Features And Benefits	3-1
Washer Use	3-2
Washer Care	3-11
Troubleshooting	3-14
COMPONENT ACCESS	4-1
Component Locations	4-1
Removing The Console, The Touchpad/LED Assembly And Central Control Unit	4-2
Removing The Water Inlet Valve	4-4
Removing The Pressure Switch	4-5
Removing The Line Filter & Power Supply Cord	4-6
Removing The Detergent Dispenser Assembly	4-8
Removing The Detergent Dispenser Motor	4-9
Removing The Door Switch Assembly And The Bellows	4-11
Removing The Drain Pump	4-14
Removing The ECO Valve	4-16
Removing The Motor Control Unit	4-17
Removing The Temperature Sensor	4-19
Removing The Drive Belt And Motor	4-20
Removing The Basket Drive Pulley	4-22
Removing The Tub And Basket	4-23
COMPONENT TESTING	5-1
Inlet Cold/Bleach Water Valve Solenoids	5-1
Inlet Hot Water Valve Solenoid	5-2
Pressure Switch	5-3
Line Filter	5-4
Door Switch	5-5
Drain Pump	5-6
Temperature Sensor	5-7
Drive Motor	5-8

	Page
DIAGNOSTICS & TROUBLESHOOTING	6-1
Diagnostics	6-1
Diagnostic Guide	6-1
Failure Codes	6-2
Diagnostic Test	6-8
Universal Diagnostics Test	6-9
Quick Diagnostic Test	6-11
Electronic Assemblies - Removal Or Replacement	6-12
Troubleshooting Guide	6-13
WIRING DIAGRAMS	7-1
Washer	7-1

GENERAL WASHER SAFETY

Your safety and the safety of others are very important.

We have provided many important safety messages in this manual and on your appliance. Always read and obey all safety messages.



This is the safety alert symbol.

This symbol alerts you to potential hazards that can kill or hurt you and others.

All safety messages will follow the safety alert symbol and either the word “DANGER” or “WARNING.” These words mean:

! DANGER

You can be killed or seriously injured if you don't immediately follow instructions.

! WARNING

You can be killed or seriously injured if you don't follow instructions.

All safety messages will tell you what the potential hazard is, tell you how to reduce the chance of injury, and tell you what can happen if the instructions are not followed.

MODEL & SERIAL NUMBER DESIGNATIONS

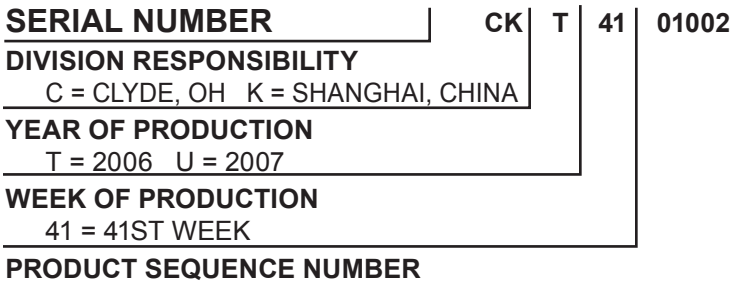
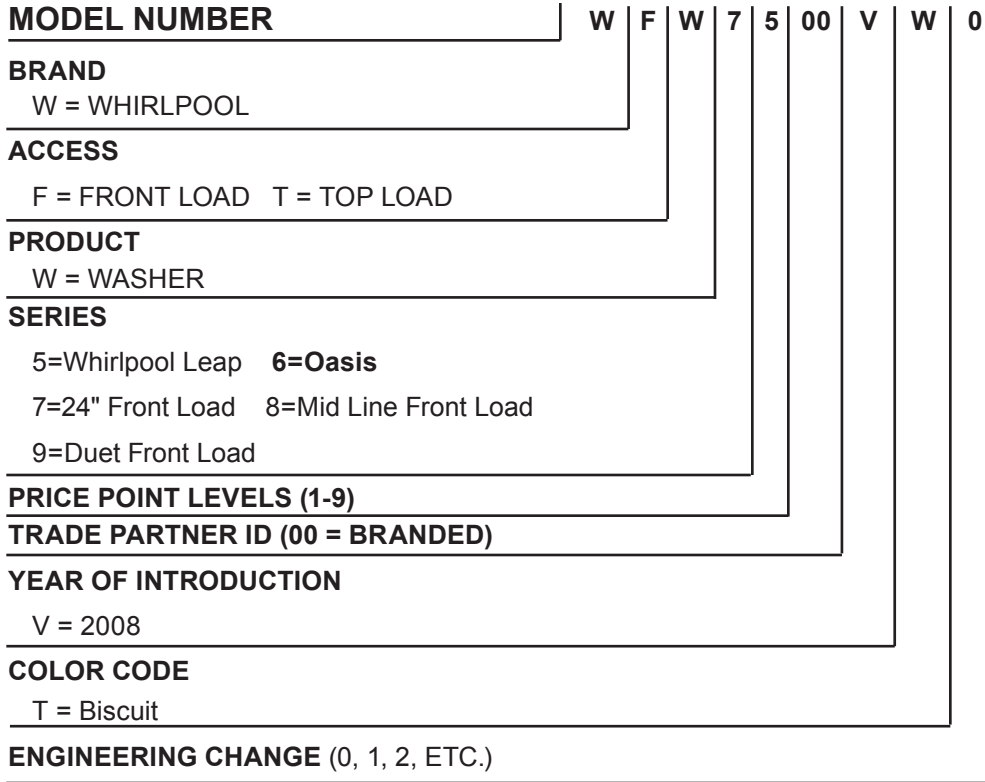

MODEL & SERIAL NUMBER LABEL AND TECH SHEET LOCATIONS

The Model & Serial Number Label and Tech Sheet locations are shown below.

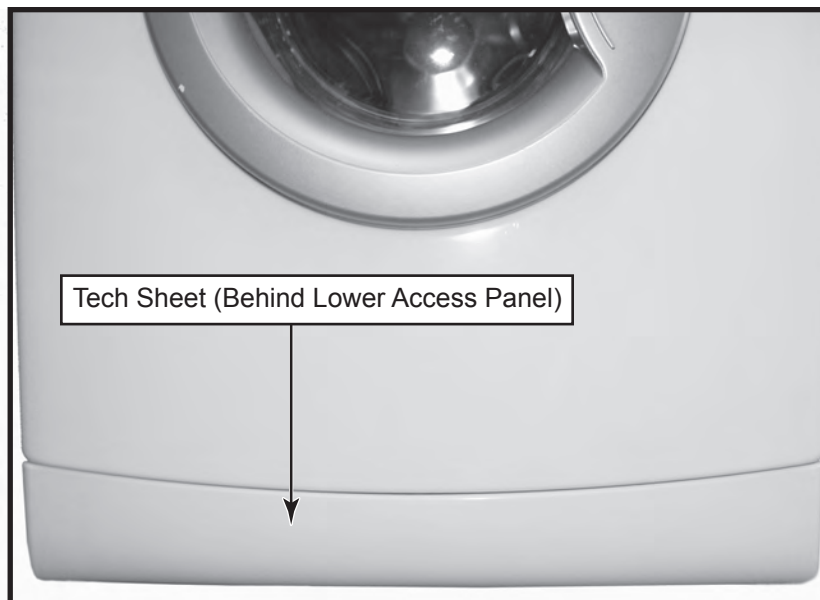

SPECIFICATIONS

Model Number	WFC7500VW0
Model Description	Front Load Washer
Color	White
Capacity (IEC Equivalent)	2.3
Temperature Control	Thermist
Heater	No
Sensors	Suds Sensor, NTC (Thermistor), Water Level Sensor
Tumble Speed	Variable
Spin Speed	1200 RPM Maximum
Motor	Variable Speed; 1/3 HP
Voltage	120V
Frequency	60 Hz
Amps	15 Amp
Water Consumption Average DOE (Gallons-Per-Cycle)	Variable per Load CEE Tier II Qualified
Height	33.5"
Install Depth: Min - Max	23.5"
Width	23.5"

INSTALLATION INFORMATION

INSTALLATION REQUIREMENTS

TOOLS AND PARTS

Gather the required tools and parts before starting installation. The parts supplied are in the washer drum.

Tools needed for connecting the water inlet hoses

- Pliers (that open to 1-9/16" [39.5 mm])
- Flashlight (optional)

Tools needed for installation

- Open end wrenches 13 mm and 12 mm
- Level
- Wood block
- Ruler or measuring tape

Parts supplied

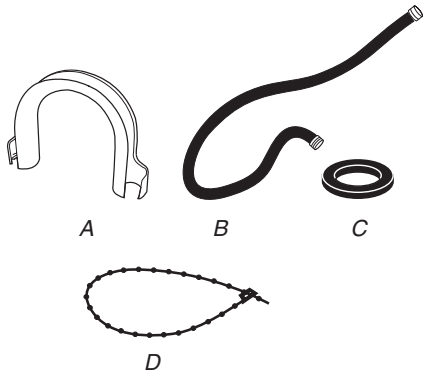

- A. U-shaped hose form
- B. Water inlet hoses (2)
- C. Inlet hose washers (4)
- D. Beaded tie strap

Alternate parts

If You Have	You Will Need to Buy
Laundry tub or standpipe taller than 55" (1.4 m)	Sump pump system (if not already available)
Overhead sewer	Standard 20 gal. (76 L), 30" (76.2 cm) tall drain tub or utility sink and sump pump (available from local plumbing suppliers)
Floor drain	Siphon break, Part Number 285834; additional drain hose Part Number 8318155; and connector kit, Part Number 285835
Drain hose too short	4 ft (1.2 m) drain hose extension kit, Part Number 285863
Water faucets beyond reach of fill hoses	2 longer water fill hoses: 6 ft (1.8 m) Part Number 76314 10 ft (3.0 m) Part Number 350008

OPTIONS

Pedestal

You have the option of purchasing pedestals of different heights separately for this washer. You may select a 11" (30.0 cm) pedestal. The pedestal will add to the total height of the washer.

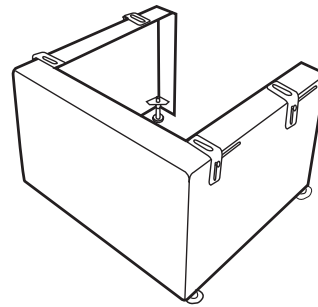

Optional pedestal

Pedestal Height	Approximate Height with Washer	Color	Model Number
11.8" (30.0 cm)	44.7" (113.5 cm)	White	LAB0050PQ

Stack Kit

Are you planning to stack your washer and dryer? To do so you will need to purchase a Stack Kit.

To order, call the dealer from whom you purchased your washer or refer to the "Assistance or Service" section. Ask for Part Number W10178021.

LOCATION REQUIREMENTS

Selecting the proper location for your washer improves performance and minimizes noise and possible washer "walk."

The washer can be installed under a custom counter, in a basement, laundry room, closet, or recessed area. See "Drain System," page 2-4.

Companion appliance location requirements should also be considered. Proper installation is your responsibility.

You will need

- A water heater set to deliver 120°F (49°C) water to the washer.
- A grounded electrical outlet located within 5.4 ft (1.65 m) of where the power cord is attached to the back of the washer. See "Electrical Requirements," page 2-5.
- Hot and cold water faucets located within 4 ft (1.2 m) of the hot and cold water fill valves, and water pressure of 20-100 psi (137.9-689.6 kPa).
- A level floor with a maximum slope of 1" (2.5 cm) under entire washer. Installing the washer on soft floor surfaces, such as carpets or surfaces with foam backing, is not recommended.
- A sturdy and solid floor to support the washer with a total weight (water and load) of 400 lbs (180 kg).

Do not operate your washer in temperatures below 32°F (0°C). Some water can remain in the washer and can cause damage in low temperatures.

Installation Clearances

- The location must be large enough to allow the washer door to be fully opened.
- Additional spacing should be considered for ease of installation and servicing. The door opens more than 90°, and it is not reversible.
- Additional clearances might be required for wall, door, and floor moldings.
- Additional spacing of 1" (2.5 cm) on all sides of the washer is recommended to reduce noise transfer.
- Companion appliance spacing should also be considered.

Washer Dimensions

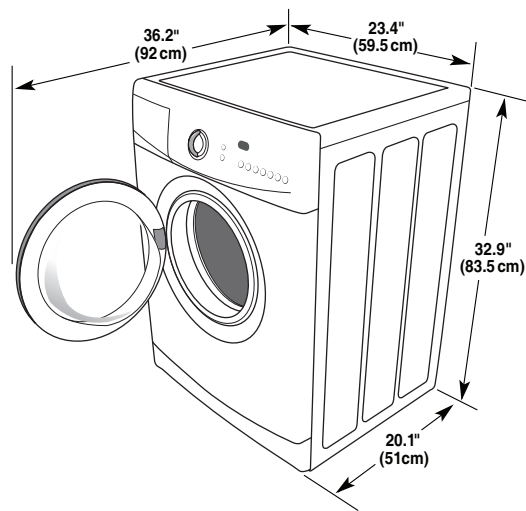

Recommended installation spacing for custom undercounter installation

The dimensions shown are for the recommended spacing.

Custom undercounter installation - Washer only

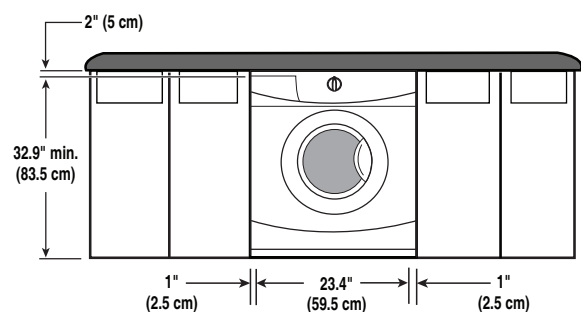

Recommended installation spacing for recessed or closet installation, with or without a pedestal

The dimensions shown are for the recommended spacing.

Recessed area or closet installation

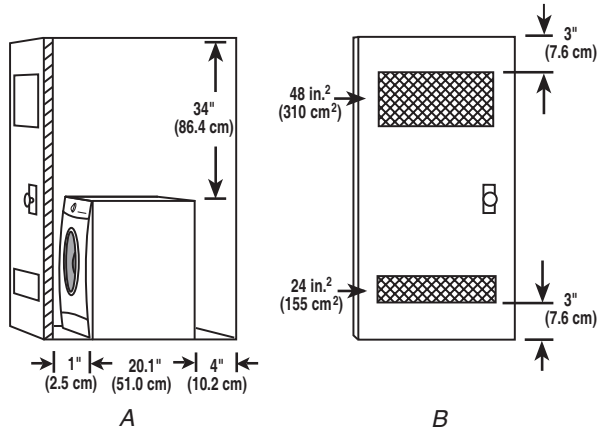

A. Side view - closet or confined area
B. Closet door with vents

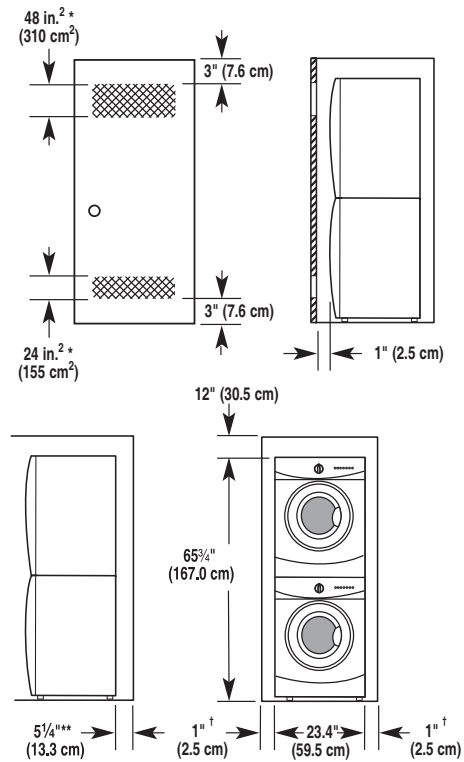

Recessed or closet installation - Washer on pedestal

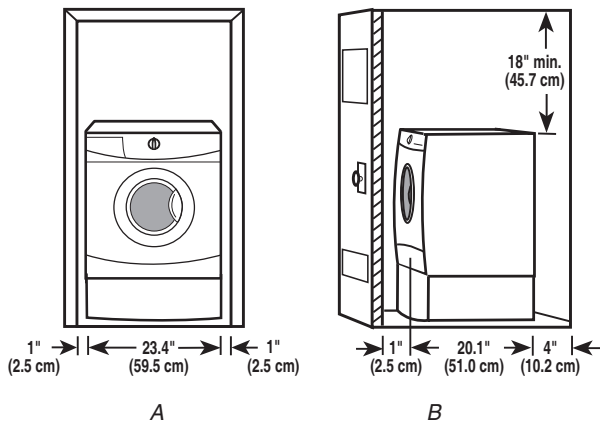

A. Recessed area
B. Side view - closet or confined area

Recommended installation spacing for recessed or closet installation, with stacked washer and dryer

The dimensions shown, at the top of the right column, are for the recommended spacing.

* Min. top and bottom air openings for closet door.

** External exhaust elbow requires additional space.

† Wall, door and floor molding may require additional spacing.

Recommended installation spacing for cabinet installation

The dimensions shown are for the recommended spacing.

For cabinet installation with a door, the minimum ventilation openings in the top are required.

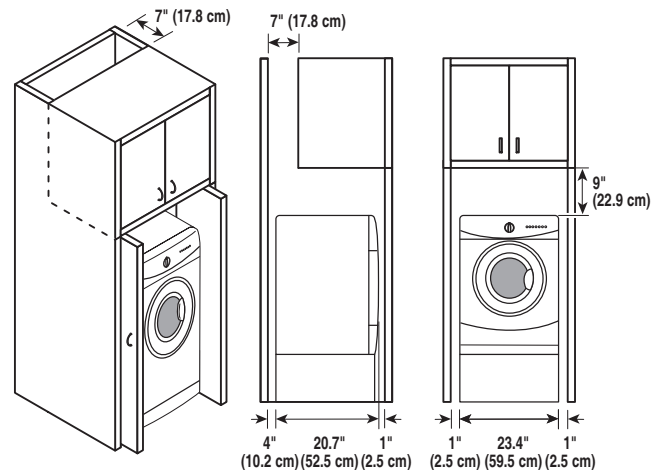

DRAIN SYSTEM

The washer can be installed using the standpipe drain system (floor or wall), the laundry tub drain system or the floor drain system. Select the drain hose installation method you need. See “Tools and Parts,” page 2-1.

Standpipe drain system - wall or floor (views A & B)

The standpipe drain requires a minimum diameter standpipe of 2" (5 cm). The minimum carry-away capacity can be no less than 17 gal. (64 L) per minute.

The top of the standpipe must be at least 30" (76.2 cm) high and no higher than 55" (1.4 m) from the bottom of the washer.

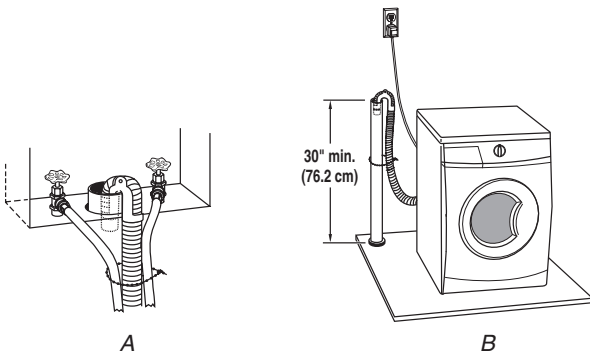

Laundry tub drain system (view C)

The laundry tub needs a minimum 20 gal. (76 L) capacity. The top of the laundry tub must be at least 30" (76.2 cm) above the floor.

Floor drain system (view D)

The floor drain system requires a siphon break that may be purchased separately. See “Tools and Parts,” page 2-1.

The siphon break must be a minimum of 26" (66 cm) from the bottom of the washer. Additional hoses might be needed.

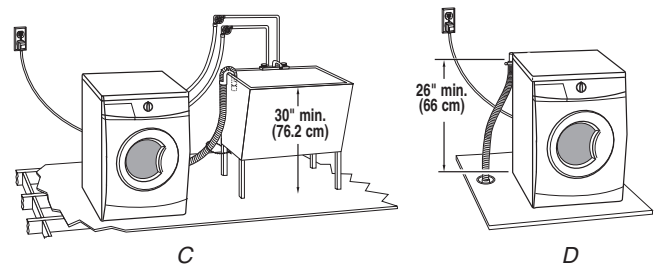

ELECTRICAL REQUIREMENTS

WARNING



Electrical Shock Hazard

Plug into a grounded 3 prong outlet.

Do not remove ground prong.

Do not use an adapter.

Do not use an extension cord.

Failure to follow these instructions can result in death, fire, or electrical shock.

- A 120 volt, 60 Hz., AC only, 15- or 20-amp, fused electrical supply is required. A time-delay fuse or circuit breaker is recommended. It is recommended that a separate circuit serving only this appliance be provided.
- This washer is equipped with a power supply cord having a 3 prong grounding plug.
- To minimize possible shock hazard, the cord must be plugged into a mating, 3 prong, grounding-type outlet, grounded in accordance with local codes and ordinances. If a mating outlet is not available, it is the personal responsibility and obligation of the customer to have the properly grounded outlet installed by a qualified electrician.
- If codes permit and a separate ground wire is used, it is recommended that a qualified electrician determine that the ground path is adequate.
- Do not ground to a gas pipe.
- Check with a qualified electrician if you are not sure the washer is properly grounded.
- Do not have a fuse in the neutral or ground circuit.

GROUNDING INSTRUCTIONS

For a grounded, cord-connected washer:

This washer must be grounded. In the event of a malfunction or breakdown, grounding will reduce the risk of electrical shock by providing a path of least resistance for electric current. This washer is equipped with a cord having an equipment-grounding conductor and a grounding plug. The plug must be plugged into an appropriate outlet that is properly installed and grounded in accordance with all local codes and ordinances.

WARNING: Improper connection of the equipment-grounding conductor can result in a risk of electric shock. Check with a qualified electrician or serviceman if you are in doubt as to whether the appliance is properly grounded.

Do not modify the plug provided with the appliance – if it will not fit the outlet, have a proper outlet installed by a qualified electrician.

For a permanently connected washer:

This washer must be connected to a grounded metal, permanent wiring system, or an equipment-grounding conductor must be run with the circuit conductors and connected to the equipment-grounding terminal or lead on the appliance.

INSTALLATION INSTRUCTIONS

REMOVE TRANSPORT SYSTEM

⚠ WARNING

Excessive Weight Hazard

Use two or more people to move and install washer.

Failure to do so can result in back or other injury.

IMPORTANT: Position the washer so that the rear of the unit is within approximately 3 ft (90 cm) of the final location.

There are 4 bolts in the rear panel of the washer that support the suspension system during transportation. These bolts also retain the power cord inside the washer until the bolts are removed.

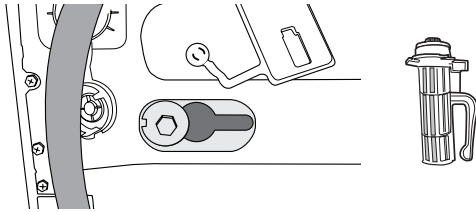

1. Using a 12 mm wrench, loosen each of the bolts.
2. Once the bolt is loose, move it to the center of the hole and completely pull out the bolt, including the plastic spacer covering the bolt.

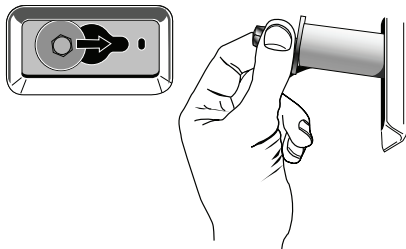

3. Once all 4 bolts are removed, discard the bolts and spacers. Then pull the power cord through the opening of the rear panel and close the hole with the attached cap.

4. Close the bolt holes with the 4 transport bolt hole plugs.

NOTE: If the washer is to be transported at a later date, call your local service center. To avoid suspension and structural damage, your machine must be properly set up for re-location by a certified technician.

CONNECT THE INLET HOSES

Insert new flat washers (supplied) into each end of the inlet hoses. Firmly seat the washers in the couplings.

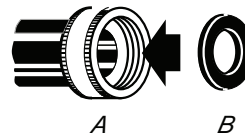

A. Coupling
B. Washer

Connect the inlet hoses to the water faucets

Make sure the washer drum is empty.

1. Attach a hose to the hot water faucet. Screw on coupling by hand until it is seated on the washer.
2. Attach a hose to the cold water faucet. Screw on coupling by hand until it is seated on the washer.
3. Using pliers, tighten the couplings with an additional two-thirds turn.

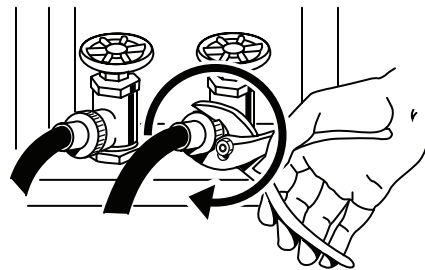

NOTE: Do not overtighten or use tape or sealants on the valve. Damage to the valves can result.

Clear the water lines

1. Run water through both faucets and inlet hoses, into a laundry tub, drainpipe or bucket, to get rid of particles in the water lines that might clog the inlet valve screens.
2. Check the temperature of the water to make sure that the hot water hose is connected to the hot water faucet and that the cold water hose is connected to the cold water faucet.

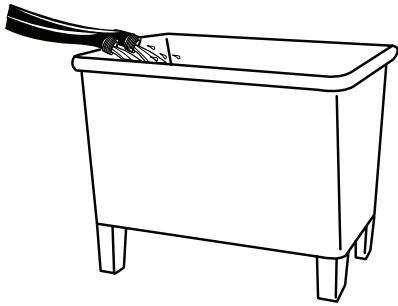

Connect the inlet hoses to the washer

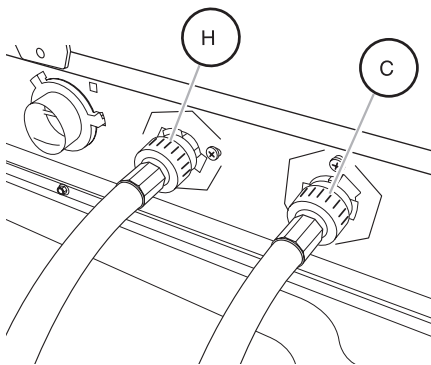

H. Hot water inlet
C. Cold water inlet

1. Attach the hot water hose to the washer's hot (H) water inlet valve. Screw on coupling by hand until it is seated on the washer.
2. Attach the cold water hose to the washer's cold (C) water faucet. Screw on coupling by hand until it is seated on the washer.
3. Using pliers, tighten the couplings with an additional two-thirds turn.

NOTE: Do not overtighten. Damage to the coupling can result.

4. Turn on the water faucets completely and check for leaks.

NOTE: Replace inlet hoses after 5 years of use to reduce the risk of hose failure. Record hose installation or replacement dates on the hoses for future reference.

Periodically inspect and replace hoses if bulges, kinks, cuts, wear, or leaks are found.

ROUTE THE DRAIN HOSE

Proper routing of the drain hose protects your floors from damage due to water leakage. Read and follow these instructions.

Remove drain hose from the washer

Gently pull the corrugated drain hose from the shipping clips.

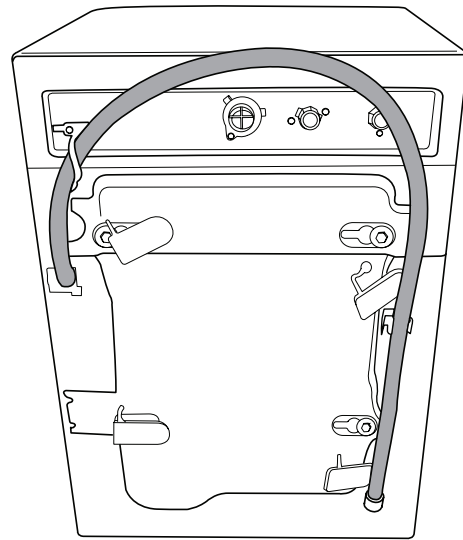

Laundry tub drain or standpipe drain

Connect the drain hose form to the corrugated drain hose.

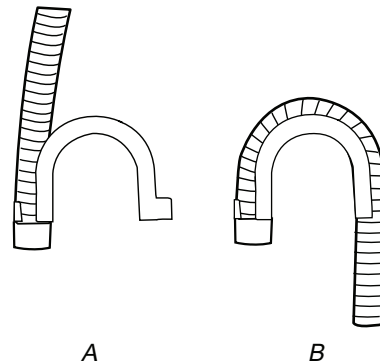

A. Snap either end of the drain hose form to the drain hose at the point where the corrugation begins.

B. Bend drain hose over drain hose form and snap into place.

To keep drain water from going back into the washer:

- Do not straighten the drain hose, and do not force excess drain hose into standpipe. Hose should be secure, but loose enough to provide a gap for air.
- Do not lay excess hose on the bottom of the laundry tub.

Floor drain

You may need additional parts. See Floor Drain under “Tools and Parts,” page 2-1.

SECURE THE DRAIN HOSE

1. Drape the power cord over the washer top.
2. Move the washer to its final location.
3. Place the drain hose in the laundry tub or standpipe. See illustrations A and B.

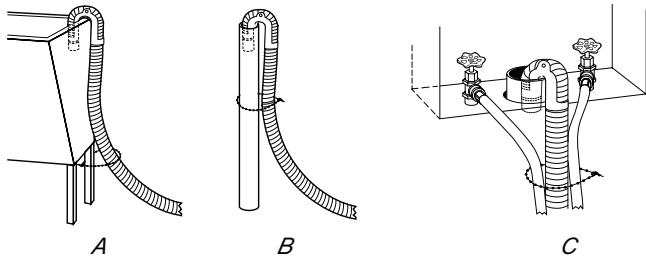

4. If the washer faucets and the drain standpipe are recessed, put the hooked end of the drain hose in the standpipe. See illustration C.

NOTES:

- Do not force excess drain hose back into the rear of the washer.
- To prevent siphoning, do not seal the drain hose into the standpipe.

LEVEL THE WASHER

Properly leveling your washer avoids excessive noise and vibration.

1. Check the levelness of the washer by placing a level on the top edge of the washer, first side to side, then front to back.

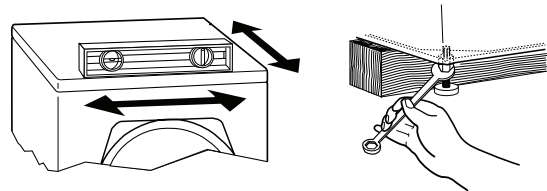

If the washer is against a wall, move the washer out slightly before tipping back. First prop the front with a wood block and adjust the feet as necessary; then prop the back and adjust feet as necessary. Repeat this step until washer is level.

2. Make sure that all four feet are stable and resting on the floor. Then check that the appliance is perfectly level (use a level).
3. After the washer is level, use a 13 mm open-end wrench to turn the nuts on the feet tightly against the washer cabinet.

IMPORTANT: All four feet must be tightened. If the nuts are not tight against the washer cabinet, the washer may vibrate.

4. Slide the washer to its final location.
5. The washer should not move front to back, side to side, or diagonally when pushed on its top edges.
6. Confirm the levelness of the washer.

COMPLETE INSTALLATION

1. Check the electrical requirements. Be sure that you have the correct electrical supply and the recommended grounding method. See "Electrical Requirements," page 2-5.
2. Check to be sure all parts are now installed. If there is an extra part, go back through the steps to see which step was skipped.
3. Check that you have all of your tools.
4. Dispose of or recycle all packaging materials.
5. Check that the water faucets are on.
6. Check for leaks around faucets and inlet hoses.

WARNING



Electrical Shock Hazard

Plug into a grounded 3 prong outlet.

Do not remove ground prong.

Do not use an adapter.

Do not use an extension cord.

Failure to follow these instructions can result in death, fire, or electrical shock.

7. Plug into a grounded 3 prong outlet.
8. Read "Washer Use," page 3-2.
9. To test and to clean your washer, use 1/2 the manufacturer's recommended amount of detergent for a medium sized load. Pour the detergent into the detergent dispenser. Select NORMAL/CASUAL, and then select START. Allow the washer to complete one whole cycle.



Use only HE High Efficiency detergent.

— NOTES —

PRODUCT OPERATION

FEATURES AND BENEFITS

The front-loading high efficiency washer was designed to conserve resources and lower your water and energy bills. The washer is designed to determine and then provide the amount of water needed for the best performance. The time of operation may be greater for this new system than for a conventional washer.

ELECTRONIC CONTROLS

Flexible electronic controls are easy to use whether you are a beginner or an expert.

AUTO WATER LEVEL

Adjusting to the size of the load, this feature allows the washer to use the minimal amount of water needed to clean and rinse the clothes. With a low water level, you can obtain the same results with smaller amounts of additives. Because only the required amount of water is used, the washer saves energy, too. You can obtain the same washing results for small and large loads size.

SUSPENSION SYSTEM

To reduce washer “walk” and “off-balance” conditions, your new washer combines:

- 2 Springs to isolate vibration
- 2 shock absorbers at the washer base to minimize movement

STAINLESS STEEL DRUM

The stainless steel drum eliminates corrosion and enables higher spin speeds for more water extraction, reducing drying time.

ADAPTIVE VARIABLE SPEED MOTOR

The motor adapts to the load size and to the cycle selected to give the optimum cleaning, rinsing, and spinning conditions. The motor can handle slow speeds needed for delicate items and is powerful enough to drive an average clothes load up to a high-speed spin.

SPIN SPEEDS

This washer automatically selects the spin speed based on the cycle selected.

DYNAMIC BALANCE

A precision balancing system allows the washer to reach high-speed spins. The washer spins faster so that clothes coming out of the washer will have less moisture than with traditional top load machines. In addition, if the Dynamic Balance system detects off-balance loads during spinning, it redistributes the clothes so that they are evenly balanced.

SMART DISPENSERS

The three compartments in the dispenser allow loading of all laundry products before the washer is started. The products will be dispensed into the wash at the optimal time for high performance cleaning. The bleach release system is included in the detergent advantage system. The detergent is added at the beginning of the cycle, and the bleach is added after the enzymes have had a chance to do their cleaning. The fabric softener is dispensed in the rinse cycle or in the EXTRA RINSE, if selected. The Detergent Advantage System Dispenser tray is easily removed for cleaning.



Use only HE High Efficiency detergent.

WASHER USE

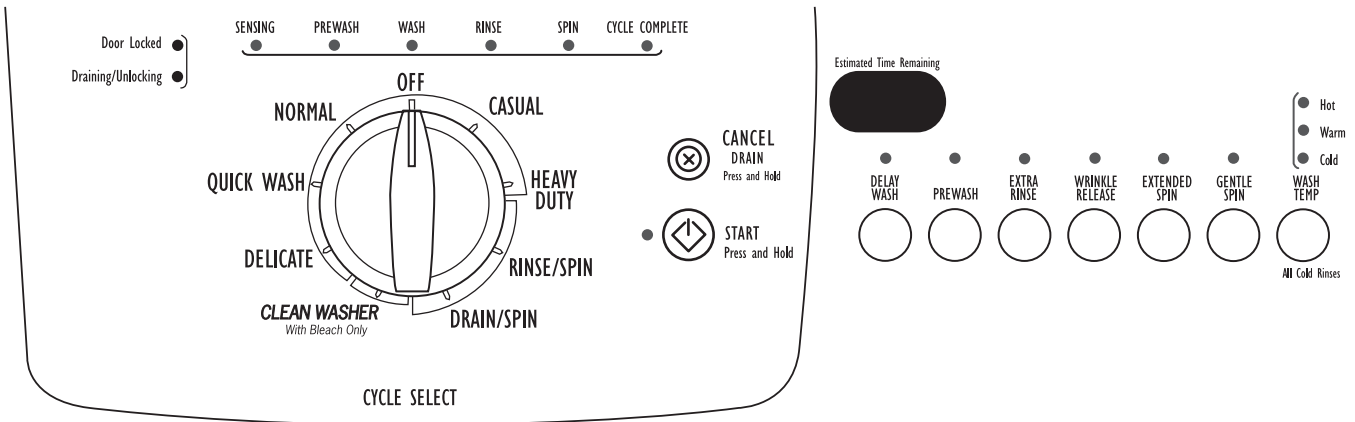

STARTING THE WASHER

WARNING



Fire Hazard

Never place items in the washer that are dampened with gasoline or other flammable fluids.

No washer can completely remove oil.

Do not dry anything that has ever had any type of oil on it (including cooking oils).

Doing so can result in death, explosion, or fire.

The following is a guide to using the washer. Please refer to specific sections of this manual for more detailed information.

Do not store laundry products on the top surface of this washer. Vibration is normal during operation.

USING THE PROPER DETERGENT

Use only High Efficiency detergents. The package for this type of detergent will be marked “HE” or “High Efficiency.” This wash system, along with less water, will create too much sudsing with a regular non-HE detergent. Using regular detergent will likely result in washer errors, longer cycle times, and reduced rinsing performance. It may also result in component failures and noticeable mold or mildew. HE detergents are made to produce the right amount of suds for the best performance. Follow the manufacturer’s instructions to determine the amount of detergent to use.



Use only HE High Efficiency detergent.

First Wash Cycle Without Laundry

Before washing clothes for the first time, if not completed during the final installation step, choose the Normal/Casual cycle and run it without clothes. Use only HE High Efficiency detergent. Use 1/2 the manufacturer’s recommended amount for a medium-sized load. This initial cycle serves to ensure the interior is clean before washing clothes.

For All Wash Cycles

1. To load washer

Open the washer door by pulling on the handle. Sort laundry according to color and type of fabric. Place a load of sorted clothes in the washer. Do not overload washer. Overloading can cause poor cleaning.

- The washer can be fully loaded, but not tightly packed. Washer door should close easily.
- Mix large and small items. Avoid washing a single item. Load evenly.
- Wash small items such as infant socks in mesh garment bags. It is recommended that more than one garment bag be used and that each garment bag be filled with equal amounts of material.
- When unloading garments, occasionally

check under the rubber rim at the front of the tub for small items.

2. Close the washer door by pushing it firmly until the lock clicks. The washer door will remain locked during the wash cycle.

NOTE: There is a routine at the beginning of each cycle to avoid unintended use of the washer. This routine will take approximately 1 minute to complete before the selected wash cycle begins.

3. Open the dispenser drawer and add laundry additives to the detergent, bleach, or fabric softener compartments. Close drawer slowly to avoid spills. See “Using the Dispenser.”
4. Turn on the washer by turning the cycle selector and selecting one of the cycles. The indicator light for the selected cycle will illuminate. When selecting a Wash Cycle, the preset Modifiers, Options and Water Temp for the selected cycle will illuminate. The preset settings provide the recommended fabric care for the selected cycle. See “Cycles.”
5. Select the desired OPTIONS. Not all Options are available with all cycles. See “Options.”
6. **To begin the wash cycle immediately** Select and hold START (for approximately 3 seconds).
 - If you do not select START within 5 minutes of choosing a cycle, the washer display automatically shuts off.
 - When the wash cycle is complete, the CYCLE COMPLETE status light illuminates, the door unlocks and the wash load can be removed from the washer. The washer goes into standby mode automatically after the door is opened or 1 hour after the cycle is complete and all displays will go off.
 - To power down the washer manually after the wash cycle is complete, switch knob to Off position.

7. **To begin the wash cycle later** Select DELAY WASH until the desired delay time (in hours) is displayed. Select START. The countdown to the wash cycle will show in the display window.

IMPORTANT: When delaying a cycle, use only powdered detergents in the main wash compartment since liquid detergents may seep out of the compartment during Delay before the wash cycle begins.

USING THE DISPENSER

The washer has a dispenser drawer with three separate compartments for your laundry additives—one is for detergent, one is for liquid chlorine bleach, and one is for liquid fabric softener. Laundry additives are diluted and dispensed automatically at the proper time during the wash cycle, making it unnecessary for you to return to the washer during the cycle to add them.

It is normal for small amounts of water to remain in the dispensers when the wash cycle is complete.

Do not put laundry additives directly into the wash tub. Always use the proper dispensers when adding laundry additives.

Choosing the Right Detergent

Use only High Efficiency detergents. The package for this type of detergent will be marked “HE” or “High Efficiency.” This wash system, along with less water, will create too much sudsing with a regular non-HE detergent. Using regular detergent will likely result in washer errors, longer cycle times, and reduced rinsing performance. It may also result in component failures and noticeable mold or mildew. HE detergents are made to produce the right amount of suds for the best performance. Follow the manufacturer’s instructions to determine the amount of detergent to use.



Use only HE High Efficiency detergent.

To fill dispenser compartments

1. Pull out the dispenser drawer.
2. Add the desired laundry products to the proper compartment.
3. Push in the dispenser drawer slowly and completely (to avoid a spill).

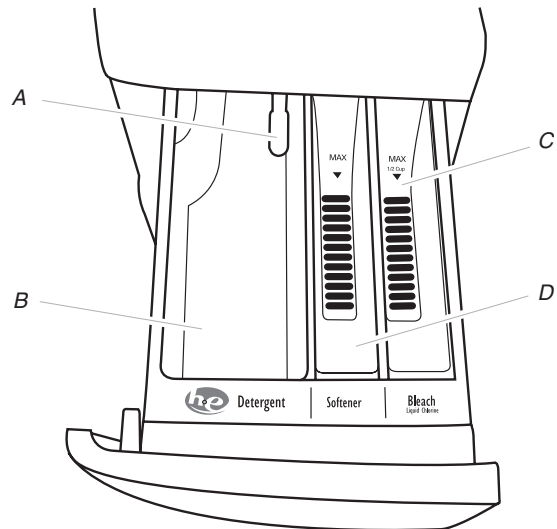

Dispenser

- A. Dispenser release lever
- B. Main Wash detergent compartment
- C. Liquid chlorine bleach compartment
- D. Fabric softener compartment

Main Wash detergent compartment (Letter B in Dispenser Illustration)

Add liquid or powdered HE detergent to this compartment for your main wash cycle.

- Powdered color-safe bleach may be added to the Main Wash compartment along with the powdered detergent.

- Follow the manufacturer’s instructions to determine the amount of detergent to use.

NOTE: Overfilling could cause an oversudsing condition.

Chlorine bleach compartment
(Letter C in Dispenser Illustration)

Add NO MORE THAN 1/2 cup (120 mL) liquid chlorine bleach to this compartment. The bleach will be automatically diluted and dispensed at the best time during the first rinse after the wash cycle. This compartment cannot dilute powdered bleach.

- Use only liquid chlorine bleach in this dispenser. Do not use this dispenser to add powdered chlorine or any form of colorsafe bleach to your load.
- Always measure liquid chlorine bleach. Use a measuring cup with a pour spout; do not guess. Follow the manufacturer’s directions for proper use.
- Do not fill beyond the “MAX” level.

NOTE: Overfilling could cause garment damage.

Fabric softener compartment
(Letter D in Dispenser Illustration)

Add 1/2 cup (120 mL) liquid fabric softener to this compartment. Fabric softener will be automatically dispensed in the final rinse or in the EXTRA RINSE, if selected.

- Do not fill beyond the “MAX” level.

RESTARTING

To restart the washer at any time, select CANCEL/DRAIN.

CHANGING CYCLES AND OPTIONS

Not all Options are available with all Cycles.

Cycles and Options can be changed anytime before START is selected.

To stop a cycle and select a new cycle

1. Press and hold CANCEL/DRAIN for 3 seconds.
2. Select desired cycle..
3. Select the desired OPTIONS.
4. Select and hold START (for approximately 3 seconds) to restart the washer at the beginning of the new cycle.

To cancel a cycle and to drain the washer manually

1. Press and hold CANCEL/DRAIN for 3 seconds.
2. The pump will turn on to drain out the water and the door will unlock.

NOTE: It will take approximately 1 minute for the door to unlock.

3. The washer cycle stops, the door unlocks and clothes can be removed.
4. To power down the washer manually after the wash cycle is complete, switch knob to Off position.

NOTE: If the water level is too high, the washer will drain automatically before the door unlocks.

STATUS LIGHTS

These lights show which portion of the cycle the washer is operating.



Sensing

The washer automatically weighs items then adjusts the Estimated Time Remaining, based on the cycle selected.

Cycle Complete

The Cycle Complete status light stays on for 1 hour after the cycle is complete. To power down the washer manually after the wash cycle is complete, switch knob to Off position.

Estimated Time Remaining

The cycle times vary automatically based on your water pressure, water temperature, detergent, and clothes load. The cycle time will be extended if oversudsing occurs or the load is unbalanced. The oversuds routine removes extra suds and assures proper rinsing of your garments. The options you select will also affect the cycle times that are shown in the Pre-set Cycle Settings table. The Estimated Time Remaining can change to much longer times under extreme conditions.

Door Locked

When the Door Locked LED light illuminates, the door is locked. The door is locked and unlocked automatically, depending on the stage of the wash cycle. Press and hold CANCEL/DRAIN for 3 seconds to unlock the door manually. It will take approximately 1 minute for the door to unlock..

Cycles

Wash Cycles

Choose Wash Cycles by rotating the Cycle selector knob to the desired cycle. The indicator light for the cycle selected will illuminate. Each cycle is designed for different types of fabric and soil levels.

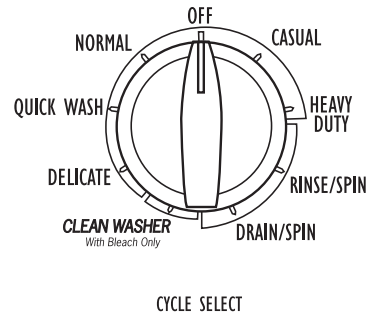

- Each cycle has a default cycle time, WASH TEMP, and may have preset Options. The preset settings provide the recommended fabric care for the selected cycle.
- The preset settings can be changed anytime before START is selected. Not all Options and Modifiers (WASH TEMP, spin options) are available with all Cycles. Select and hold START (for approximately 3 seconds) to continue the cycle.

Preset Cycle Settings

Each cycle has a preset Cycle Time and WASH/RINSE TEMP. The preset settings provide the recommended fabric care for the selected cycle. See chart..

Cycle	Estimated Time* (hr:min)	Wash Temp	Spin Speed
Normal	0:50	Warm	High
Quick Wash (2-3 items)	0:30	Warm	High
Delicate	0:37	Warm	Low
Clean Washer	1:15	Hot	High
Drain/Spin	0:18	N/A	High
Rinse/Spin	0:24	Cold	High
Heavy Duty	1:10	Warm	High
Casual	0:45	Warm	Low

* The cycle times vary automatically based on your water pressure, water temperature, detergent, and clothes load. The cycle time will be extended if oversudsing occurs or the load is unbalanced.

Normal

Use this cycle to wash loads of normally soiled cottons and linens. This cycle has high-speed spin.

Quick Wash

Use this cycle to wash small loads of 2-3 lightly soiled garments that are needed in a hurry. This cycle combines a shortened wash time and high-speed spin to shorten drying time. Large wash loads will result in the machine increasing the wash time.

Delicate

Use this cycle to wash sheer fabrics and lingerie. This cycle has low-speed spin for gentle fabric care.

- Use mesh garment bags to wash undergarments such as underwire bras, items with strings, and small items such as socks.

Clean Washer

Use the Clean Washer cycle once a month to keep the inside of your washer fresh and clean. This cycle uses a higher water level. Use with AFFRESH™ washer cleaner tablet or liquid chlorine bleach to thoroughly clean the inside of your washing machine. This cycle should not be interrupted. See “Cleaning Your Washer.”

Drain/Spin

Use this cycle to drain your washer or to drain and spin your wash load. The spin speed is preset to HIGH.

Rinse/Spin

Use this cycle to get a rinse and spin only. This cycle has highspeed spin.

Rinse & Spin is useful for:

- Loads that need rinsing only.
- Adding fabric softener to a load using the fabric softener dispenser

Heavy Duty

Use this cycle to wash loads of sturdy, colorfast fabrics and Heavy soiled garments. This cycle combines a longer wash time and high-speed spin to shorten drying times.

Casual

Use this cycle to wash loads of permanent press blends and synthetic fabrics. This cycle has a load cooling process to reduce wrinkling.

NORMAL SOUNDS

As with any new product, you will hear sounds that you are not accustomed to. You may hear various sounds when the door is locked or unlocked, and during the washing, rinsing, or spinning process. Between changes in wash actions, there will be momentary pauses. You will hear water spraying and splashing during the wash and rinse cycles. These new sounds and pauses are part of normal washer operation. See “Troubleshooting.”

OPTIONS AND MODIFIERS

You can customize your wash by adding options to your cycle selections. Not all Options are available with all cycles.

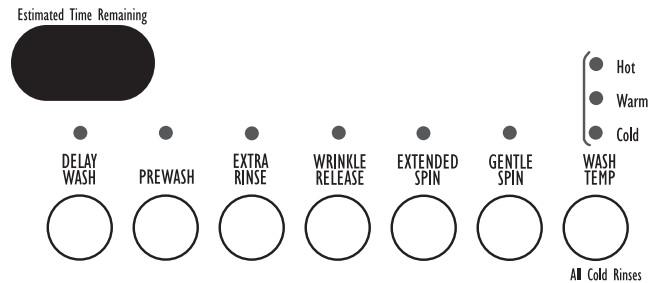

- See the “Laundry Guide” section for an overview of possible options for each Wash Cycle selection.
- If an option is available with a selected cycle, the light for that option will illuminate when selected.
- If an option is unavailable with a selected cycle, there will be a blinking light. The light for that option will not illuminate when selected.

Delay Wash

Use this to begin the wash cycle later.

- Select DELAY WASH until the desired time (in hours) shows in the Estimated Time Remaining display.
- Select START. The countdown to the wash cycle will show in the display window.

Prewash

Prewash is an 18-minute soak phase that is added before the main wash. During prewash, there is only a small amount of tumbling.

Extra Rinse

An extra rinse can be used to aid in the removal of detergent or bleach residue from garments. This option provides an additional rinse with the same water temperature as in the normal rinse. You may select or deselect by pressing EXTRA RINSE.

Wrinkle Release

Use this option to increase the quantity of incoming water and decrease the spin speed and duration in the rinse period. The last spin phase will have a lower spin speed and last a shorter time.

Extended Spin

Use this option to increase the final spin period by 1 minute during the final spin.

Gentle Spin

Each cycle has a preset spin speed. To reduce the final spin speed, select the GENTLE SPIN button.

Wash Temp

Each cycle has a preset water temperature setting. To change the water temperature, select the WASH TEMP button until the desired setting is illuminated.

Select a water temperature based on the type of load you are washing. Use the warmest wash water safe for fabrics. Follow garment label instructions.

The water temperature for all rinse cycles is cold. Cold rinses save energy.

Temperature Guide

Temperature Guide

Wash Water Temperature	Suggested Fabrics
HOT	Whites and pastels Heavy soils
WARM	Bright colors Moderate to light soils
COLD	Colors that bleed or fade Light soils

In wash water temperatures colder than 60°F (15.6°C), detergents do not dissolve well. Soils may be difficult to remove.

Auto Temp Control

ATC (Auto Temp Control) electronically senses and maintains a uniform water temperature. ATC regulates incoming hot and cold water. The ATC is automatically turned ON when a cycle is selected. See Preset Cycle Settings table in “Cycles.”

- ATC works for the wash temperature with Warm and Cold settings.
- The Cold rinse temperatures depend on the cold water at the faucet.

LAUNDRY GUIDE

Refer to the chart below for suggested load types and their corresponding cycles. Listed to the right are the options available to each of these washer cycles.

CYCLE	SUGGESTED LOAD TYPE	AVAILABLE OPTIONS					
		Delay Wash	Pre-wash	Extra Rinse*	Wrinkle Release*	Extended Spin	Gentle Spin
Normal	Normally soiled cotton and linens	✓	✓	✓		✓	✓
Quick Wash	Small loads of 2-3 lightly soiled cotton, polyester, nylon and cotton blends	✓	✓	✓	✓	✓	✓
Delicate	Curtains and delicate clothing, dresses, skirts, shirts and blouses	✓	✓	✓	✓		✓
Clean Washer	No clothes, use AFFRESH™ washer cleaner or chlorine bleach						
Drain/Spin	All loads	✓				✓	✓
Rinse & Spin	All loads	✓		✓		✓	✓
Heavy Duty	Heavily soiled underwear, towels, shirts, etc., made of cotton	✓	✓	✓		✓	✓
Casual	Normally soiled permanent press blends and synthetic fabrics	✓	✓	✓	✓	✓	✓

*NOTE: You cannot select Extra Rinse and Wrinkle Release for the same load.

WASHER CARE

CLEANING THE WASHER

Cleaning the Door Seal/Bellow

1. Open the washer door and remove any clothing or items from the washer.
2. Inspect the gray colored seal/bellow between the door opening and the basket for stained areas. Pull back the seal/bellow to inspect all areas under the seal/bellow and to check for foreign objects.

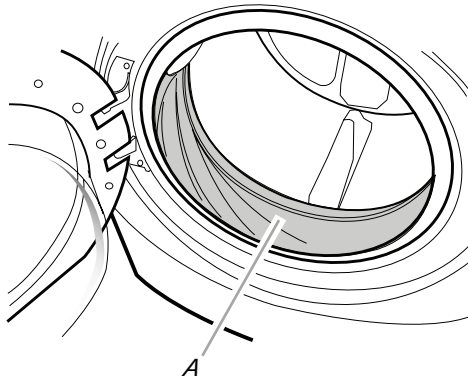

A. Seal/Bellow

3. If stained areas are found, wipe down these areas of the seal/bellow, using the procedure that follows.
 - a) Mix a dilute solution, using $\frac{3}{4}$ cup (177 mL) of liquid chlorine bleach, and 1 gal. (3.8 L) of warm tap water.
 - b) Wipe the seal/bellow area with the dilute solution, using a damp cloth.
 - c) Let stand 5 minutes.
 - d) Wipe down area thoroughly with a dry cloth and let the washer interior air dry with door open.

IMPORTANT:

- Wear rubber gloves when cleaning for prolonged periods.
- Refer to the bleach manufacturer's instructions for proper use.

Washer Maintenance Procedure

This washer has a special cycle that uses higher water volumes in combination with AFFRESH™ washer cleaner or liquid chlorine bleach to thoroughly clean the inside of the washer.

NOTES:

- Read these instructions completely before beginning the cleaning process.
- If necessary, the cleaning cycle may be interrupted by pressing the CANCEL/DRAIN button. This will stop the cycle. A RINSE/SPIN cycle must then be run to thoroughly rinse the remaining bleach from the washer. Failure to do so will cause damage to the washer and clothing added to the next cycle.

Begin procedure

1. Open the washer door and remove any clothing or items from the washer.
2. Using the AFFRESH™ washer cleaner (Recommended): Add one AFFRESH™ washer cleaner tablet to the washer drum.

If using liquid chlorine bleach:

Open the dispenser drawer and immediately add $\frac{1}{2}$ cup (120 mL) of liquid chlorine bleach to the bleach compartment.

NOTE: Do not add any detergent to this cycle. Use of more than $\frac{1}{2}$ cup (120 mL) of bleach will cause product damage over time.

3. Close the washer door and the dispenser drawer.
4. Select the CLEAN WASHER cycle.
5. Press START.

NOTE: The basket will rotate, then the door will unlock, lock again, and then the cycle will continue.

- The machine will not fill, but the basket will rotate while the washer runs a short sensing cycle. This will take approximately 3 minutes.
6. The cycle will determine if clothing or other items are in the washer.
 - a) If no items are detected in the washer, it will proceed to Step 8.
 - b) If any items are detected in the washer, "F-22" will be displayed, and the Sensing, Wash and Rinse status lights will remain lit.

- Press START to cancel the failure code. Press and hold CANCEL/DRAIN for 3 seconds to unlock the door manually. It will take approximately 1 minute for the door to unlock. Then repeat steps 1, 3 and 5 to start the cycle again.
7. Once the cycle has begun, allow the cycle to complete.
 8. After the cycle is complete, leave the door open, slightly, to allow for better ventilation and drying of washer interior.

Always do the following to maintain washer freshness

- Use only HE High Efficiency detergent.
- Leave the door slightly open after each cycle to allow for better ventilation and drying of washer interior.
- Repeat the cleaning procedure monthly, using 1/2 cup (120 mL) of liquid chlorine bleach.
- If the procedure does not sufficiently improve the machine freshness, please evaluate your installation and usage conditions for other causes.

Cleaning the exterior

Use a soft damp cloth or sponge to wipe up any spills. Occasionally wipe the outside of your washer to keep it looking new. Use mild soap and water. Do not use abrasive products.

Cleaning the dispenser drawer

The dispenser drawer is removable for easy cleaning.

1. Unlock the dispenser drawer by pressing the Release Lever. See “Using the Dispenser.” Remove the drawer.
2. Remove the inserts (the siphon from the softener and bleach compartments).
3. Wash the parts under running water.
NOTE: Do not wash components in the dishwasher.
4. Replace the inserts and return the dispenser to the drawer.

WATER INLET HOSES

Replace inlet hoses after five years of use to reduce the risk of hose failure. Periodically inspect and replace inlet hoses if bulges, kinks, cuts, wear or leaks are found.

When replacing your inlet hoses, record the date of replacement.

VACATION, STORAGE, & MOVING CARE

Install and store your washer where it will not freeze. Because some water may stay in the hoses, freezing can damage your washer. If storing or moving your washer during freezing weather, winterize it.

Non-use or vacation care:

Operate your washer only when you are at home. If you will be on vacation or not using your washer for an extended period of time, you should:

- Unplug washer or disconnect power.
- Turn off the water supply to the washer. This helps avoid accidental flooding (due to a water pressure surge) while you are away.
- Slightly open door to provide ventilation.

To winterize washer:

1. Put 1 qt (1 L) of R.V.-type antifreeze in the drum.
2. Run washer on a Drain/Spin cycle.
3. Unplug washer or disconnect power.
4. Shut off both water faucets.
5. Disconnect water inlet hoses from faucets and drain.

To use washer again:

1. Flush water pipes.
2. Reconnect water inlet hoses to faucets.
3. Turn on both water faucets.

⚠ WARNING



Electrical Shock Hazard

Plug into a grounded 3 prong outlet.

Do not remove ground prong.

Do not use an adapter.

Do not use an extension cord.

Failure to follow these instructions can result in death, fire, or electrical shock.

4. Plug in washer or reconnect power.
5. Run the washer through the Normal cycle. Use only HE High Efficiency detergent. Use 1/2 the manufacturer's recommended amount for a medium sized load.

To transport the washer:

1. If washer will be moved during freezing weather, put in 1 qt (1 L) of R.V.-type antifreeze in the drum. Run washer on a Drain/Spin cycle.
2. Unplug the power cord.
3. Disconnect the drain hose from the drain system and attach to rear panel clips.
4. Shut off both water faucets.
5. Disconnect the water inlet hoses from faucets, then drain the hoses and clip them to the rear panel of the washer.
6. **IMPORTANT:** Call service. Do not reuse transport bolts. Unit must be transported in the upright position. To avoid suspension and structural damage, your machine must be properly set up for relocation by a certified technician.

Reinstalling the washer

1. Follow the "Installation Instructions," page 2-6, to locate, level and connect the washer.
2. Run the washer through the Normal/Casual cycle to clean the washer and remove the antifreeze, if used. Use only HE High Efficiency detergent. Use 1/2 the manufacturer's recommended amount for a medium sized load.

TROUBLESHOOTING

WASHER & COMPONENTS

ERROR CODES

An error code may be shown in the Estimated Remaining display. Check the list below for potential problem and troubleshooting checks.

- **“A09” on display (Water Inlet Problem—no water or insufficient water supply)**
Check the following:

Are water faucets completely turned on?

Are screens at inlet hose connection to washer clogged? Are water inlet hoses kinked?

Are water inlet hoses frozen?

WARNING



Electrical Shock Hazard

Plug into a grounded 3 prong outlet.

Do not remove ground prong.

Do not use an adapter.

Do not use an extension cord.

Failure to follow these instructions can result in death, fire, or electrical shock.

Plug in washer or reconnect power. Press and hold START to continue the cycle or press and hold CANCEL/DRAIN to cancel the cycle. If the problem remains, call for service.

- **“A10” on display (Drain Problem)**

Unplug washer or disconnect power.

Check the following:

Is the drain hose kinked?

Is the drain hose frozen?

Is the drain hose clogged?

Is the drain hose more than 55" (1.4 m) above the floor?

- **“F” Variables [F01 - F30] (Electrical Problem)**

Switch knob or press and hold START to cancel the cycle.

Select DRAIN/SPIN if there is excessive water in the washer.

Re-select cycle and press START. If the problem remains, call for service.

NOISY, VIBRATING, OFF-BALANCE

- **Is the washer level?**

The washer must be level. The four feet should be properly installed, and the nuts should be tightened against the washer cabinet.

All four feet of the washer must be in firm contact with the floor. If the washer is on a pedestal, the washer must be secured to the pedestal and all four pedestal feet must be in firm contact with the floor.

- **Washer making a different noise?**

As with any new product, you will hear sounds that you are not accustomed to. You may hear various sounds when the door is locked or unlocked, and during the washing, rinsing, or spinning process. Between changes in wash actions, there will be momentary pauses. You will hear water spraying and splashing during the wash and rinse cycles. These new sounds and pauses are part of normal washer operation.

- **Is washer installed on a sturdy and solid floor?**

Refer to the “Installation Instructions” for flooring requirements. Noise and vibration may be reduced by placing a piece of 3/4" (19.1 mm) plywood underneath your washer.

The plywood may extend underneath both washer and dryer to keep them at equal heights.

- **Is the washer gurgling or humming?**

As water is drained from the washer, you may hear air being pulled through the pump. This happens during the end of draining. It is normal.

- **Are you washing items with metal snaps, buckles or zippers?**

You may hear metal items touching the

washer drum. This is normal.

- **Were the 4 shipping bolts in the back of the machine removed?**
See “Remove Transport System,” page 2-6.

LEAKING

- **Was the door opened during “Add a garment”?**
Water can drip off the inside of the door, when the door is opened after the start of a cycle.
- **Is HE detergent being used?**
The non-High Efficiency detergents can cause oversudsing that can leak from the rear of the washer.
- **Are the fill hoses tight?**
- **Are the fill hose gaskets properly seated?**
Check both ends of each hose. See “Connect the Inlet Hoses,” page 2-6.
- **Is the drain hose properly installed?**
The drain hose should be secured to the drainpipe or laundry tub. See “Secure the Drain Hose,” page 2-8.
- **Is the sink or drain clogged?**
Sink and drainpipe must be able to carry away 17 gal. (64 L) of water per minute. If clogged or slow, water can back up out of drainpipe or sink. Check household plumbing (laundry tubs, faucets, drainpipe, water pipes) for leaks.

DISPENSER OPERATION

- **Did you follow the manufacturer’s directions when adding detergent and fabric softener to the dispensers?**
Measure detergent and fabric softener. Slowly pour into the dispensers. Wipe up all spills. Dilute fabric softener in the fabric softener dispenser.
- **Did you put powdered or liquid color-safe bleach into the liquid chlorine bleach dispenser (on some models)?**
Add powdered or liquid color-safe bleach directly to the washer basket. Do not use the chlorine bleach dispenser for color-safe bleach.

- **Is the fabric softener dispenser clogged?**
Clean the fabric softener dispenser. See “Washer Care,” page 3-12, for details.
- **Are the laundry additives in the correct dispenser compartment?**
Add the correct amounts of detergent, fabric softener or liquid chlorine bleach to the correct compartments. Add powdered or liquid color-safe bleach to the Main Wash compartment.
- **Is there water in the dispenser at the end of the cycle?**
A small amount of water will remain in the dispenser compartment. This is normal.

WASHER ODOR

- **See “Cleaning Your Washer.”**
Are you using AFFRESH™ washer cleaner on a regular basis?
AFFRESH™ washer cleaner removes and avoids odor causing residue in all High Efficiency washers. For washers where odor is present, use 3 tablets instead of 1 tablet. After the CLEAN WASHER cycle is complete, wipe away residue if necessary.
- **Are you using HE detergent?**
Use of non-HE detergent can cause a film residue which can result in odor.
- **Did you leave the door open after use?**
This washer has a tight seal to avoid water leaks. To avoid odors leave the door open to allow the washer to dry between uses.

DOOR WON’T UNLOCK

- **Did all of the water drain out of the washer during the spin?**
Select DRAIN/SPIN to remove any water remaining in the washer. The washer door will unlock at the end of the drain. It will take 1 minute for the door to unlock.
- **Is the error code displayed?**
Failure mode will lock the door. Switch knob or press and hold START to exit, then wait for the door to unlock.
- **Is the water temperature hotter than 104°F (40°C)?**
Wait for the water temperature to drop.

WASHER OPERATION

WASHER WON'T RUN, FILL, RINSE, OR TUMBLE; WASHER STOPS

WARNING



Electrical Shock Hazard

Plug into a grounded 3 prong outlet.

Do not remove ground prong.

Do not use an adapter.

Do not use an extension cord.

Failure to follow these instructions can result in death, fire, or electrical shock.

- **Is the power cord plugged into a grounded 3 prong outlet?**
Plug power cord into a grounded 3 prong outlet.
- **Are you using an extension cord?**
Do not use an extension cord.
- **Has a household fuse blown, or has a circuit breaker tripped?**
Replace the fuse, or reset the circuit breaker.
- **Are both the hot and cold water faucets turned on?**
Turn on the water.
- **Is the water inlet hose kinked?**
Straighten the hoses.
- **Are the water inlet valve screens clogged?**
Turn off the water and remove inlet hoses from the washer. Remove any accumulated film or particles. Reinstall hoses, turn on water and check for leaks.
- **Is the washer in a normal pause in the cycle?**
The washer pauses for about 2 minutes during certain cycles. Allow the cycle to continue. Some cycles feature periods of tumbling and soak.
- **Is the washer overloaded?**
Wash smaller loads.
- **Is the washer door firmly shut?**
The door must be closed during operation.
- **Are the shipping bolts removed?**
All four shipping bolts must be removed for proper operation of the washer.
- **Has a cycle been selected, but START has not been selected and held for 1 second?**
Press and hold START, for 1 second.
- **Was the door open after completion of last cycle?**
The door must be opened and closed again to start a new cycle.

WASHER CONTINUES TO FILL OR DRAIN, DRAIN CYCLE SEEMS STUCK

- **Is the top of drain hose lower than 30" (76 cm) on washer?**
The top of the drain hose must be at least 30" (76 cm) above the floor. See "Drain System," page 2-4.
- **Does the drain hose fit too tightly in the standpipe, or is it taped to the standpipe?**
The drain hose should be loose yet fit securely. Do not seal the drain hose with tape. The hose needs an air gap. See "Secure the Drain Hose," page 2-8.

WASHER WON'T DRAIN OR SPIN, WATER REMAINS IN WASHER

- **Is the drain hose clogged, or the end of the drain hose more than 96" (2.4 m) above the floor?**
- **Is the voltage low?**
Check electrical source or call electrician.
- **Excessive suds?**
When excessive suds are detected, a special suds routine automatically starts. Cycle will complete once extra suds are removed. This will occur more frequently when a non-HE detergent is used.
- **Is the load balanced?**
A single or bulky item may cause imbalance. Add more items or redistribute the load.

NOT ENOUGH WATER / NOT ENOUGH SUDS

- **Low water?**
This washer uses very little water to provide

good cleaning results. You will see little or no water splashing in this washer. This is normal.

- **Are you using HE detergent?**
HE detergent is a low sudsing detergent. This is normal and will not affect cleaning performance.

WASH / RINSE TEMPERATURE

- **Are the hot and cold water inlet hoses reversed?**
See “Connect the Inlet Hoses.”
- **Are you washing many loads?**
As your frequency of loads washed increases, the water temperature may decrease for hot and warm temperatures. This is normal.

CYCLE TIME CHANGES/CYCLE TOO LONG

- **Estimated cycle time?**
The cycle times vary automatically based on your water pressure, water temperature, detergent, and clothes load. The cycle time will be extended if oversudsing occurs or the load is unbalanced. The SUDs routine removes extra suds and assures proper rinsing of your garments. The options you select will also affect the cycle times that are shown in the Preset Cycle Settings table.
- **Excessive suds?**
When excessive suds are detected, a special suds routine automatically starts. This routine will add time to the original cycle.
- **Did the load cause imbalance?**
When too much imbalance occurs, an imbalance routine will start to redistribute the load. During the imbalance routine the time displayed may pause until this activity is complete, then resume with the remainder of the cycle.
- **Are you washing a single item or bulky load?**
Spin time is added if an unbalanced load is detected. The washer will attempt to redistribute the load with additional tumbling.
- **Did you wash a large load on the Quick Wash cycle?**
The Quick Wash cycle is designed for smaller load sizes (2-3 items) of lightly soiled garments. If larger loads are washed in this cycle, wash time will be increased.

- **Did you wash a large load in a gentle or Delicate cycle?**
When using the Quick Wash or Delicate cycles, you should use small loads. This ensures a gentle wash for your garments without increasing cycle times.

CLOTHES CARE

LOAD TOO WET

- **Did you use the right cycle for the load being washed?**
Select a cycle with a higher spin speed.
- **Did you wash a single item or bulky items or have you overloaded the washer?**
A single item, bulky items, or overloading may cause imbalance. Add items or try to evenly distribute your wet laundry in the drum, and start a Drain/Spin cycle. If the laundry is still wet, take half of the load out of the washer and try again.
- **Did you use HE detergent?**
Suds during rinse and spin cycles can reduce spin speed. Use HE detergent.

RESIDUE, LINT, STAINS ON LOAD; GRAY WHITES, DINGY COLORS

- **Did you add detergent to the dispenser?**
For best results, add detergent to the detergent compartment. Do not add detergent to the washer drum.
- **Did you sort properly?**
Sort lint givers (towels, chenille) from lint takers (corduroy, synthetics). Dye transfer can occur when mixing whites and colors in a load. Sort dark clothes from whites and lights.
- **Did you overload the washer?**
Do not overload the washer. The washer can be fully loaded, but not tightly packed. The wash load must be balanced. Lint can be trapped in the load if overloaded.
- **Check the following:**
Was paper or tissue left in pockets?
- **Did you use enough HE detergent?**
Follow manufacturer’s recommendations for the type of load you are washing. For best performance, use only High Efficiency detergent. Use enough HE detergent to remove soil and hold it in suspension.

- **Do you have hard water?**
Use more detergent for washing heavy soils in cold or hard water.
- **Is the water colder than 60°F (15.6°C)?**
Wash water colder than 60°F (15.6°C) may not completely dissolve the detergent. Use hot or warm washes if safe for the fabric load. Make sure your hot water system is adequate to provide a hot water wash.
- **Are you using a low speed wash cycle?**
Powdered detergents may not dissolve well in a slow-speed cycle. For best results, use liquid detergent for slow-speed cycles such as Delicate.
- **Did you unload the washer promptly?**
To avoid dye transfer, unload the washer as soon as it stops.
- **Did you use a fabric softener dispensing ball?**
Dispensing balls will not operate correctly with this washer. Add liquid fabric softener to the fabric softener compartment.
- **Did you use powdered detergent in a low-speed cycle?**
Consider using liquid detergent.
- **Did you use Quick Wash on a large load?**
For best results, use Quick Wash for small, lightly soiled loads.

LOAD IS WRINKLED, TWISTED, TANGLED

- **Did you unload the washer promptly?**
Unload the washer as soon as it stops.
- **Did you use the right cycle for the load being washed?**
Use the Delicate cycle or another cycle with a low spin speed to reduce wrinkling.
- **Did you overload the washer?**
The wash load must be balanced and not overloaded. Loads should tumble freely during washing.
- **Was the wash water warm enough to relax wrinkles?**
If safe for load, use warm or hot wash water.
- **Are the hot and cold water hoses reversed?**
Check that the hot and cold water hoses are connected to the right faucets. A hot rinse followed by spin will cause wrinkling. See "Connect the Inlet Hoses."

COMPONENT ACCESS

This section instructs you on how to service each component inside the 2008 24" Front-Loading Automatic Washer. The components and their locations are shown below.

COMPONENT LOCATIONS

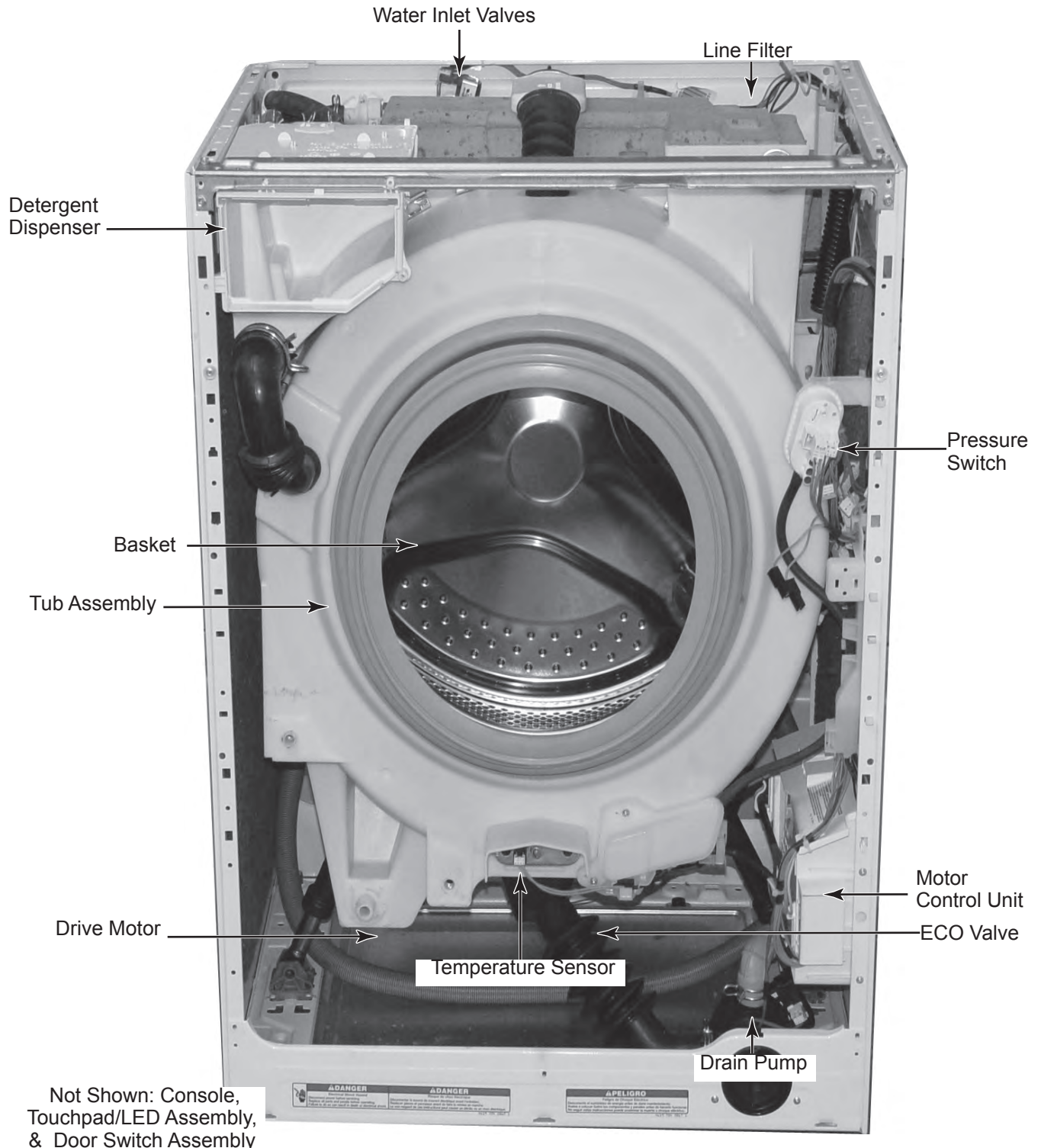

REMOVING THE CONSOLE, THE TOUCHPAD/LED ASSEMBLY AND CENTRAL CONTROL UNIT

⚠ WARNING



Electrical Shock Hazard

Disconnect power before servicing.
Replace all parts and panels before operating.

Failure to do so can result in death or electrical shock.

1. Unplug washer or disconnect power.
2. Turn off the water supply to the washer.
3. Remove the three hex-head screws from the top cover of the washer.
4. Pull back on the cover and release the cover from the slots in the unit, then lift the cover off the unit.

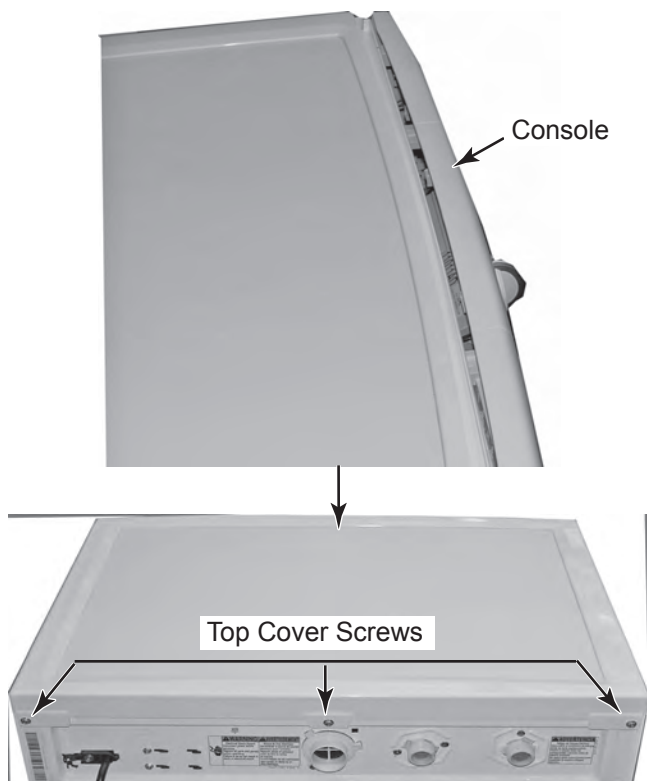

5. To remove the console:

- a) Pull the detergent dispenser drawer out as far as it will go, then press down on the release tab, and remove the drawer from the unit.

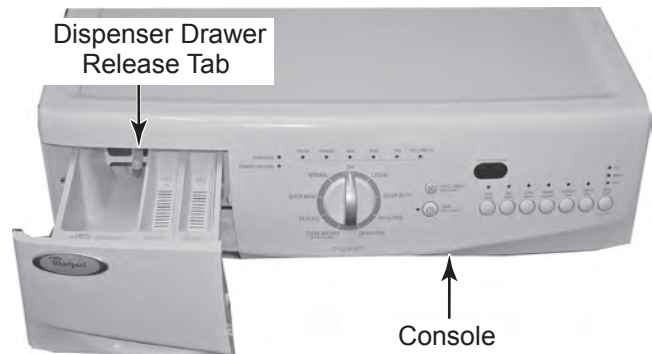

- b) Remove three screws from the recessed holes.



- c) Remove two screws from the top edge of the console.

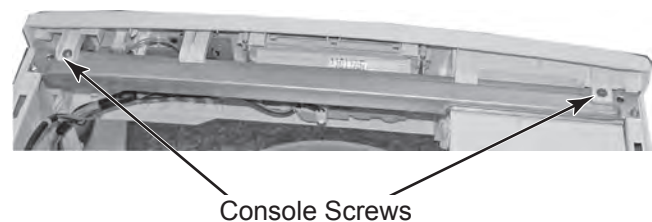

- d) Press the locking tab on the right rear side of the console outward, and release the console.



Locking Tab

- e) Disconnect wire harnesses from central control unit, touchpad/LED assembly and remove console.

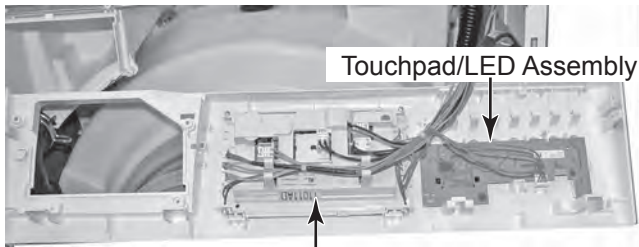

Central Control Unit

6. To remove the touchpad/LED assembly:

- a) Press the two console locking tabs, and unsnap the touchpad/LED assembly, then lift the assembly from the console and remove it.

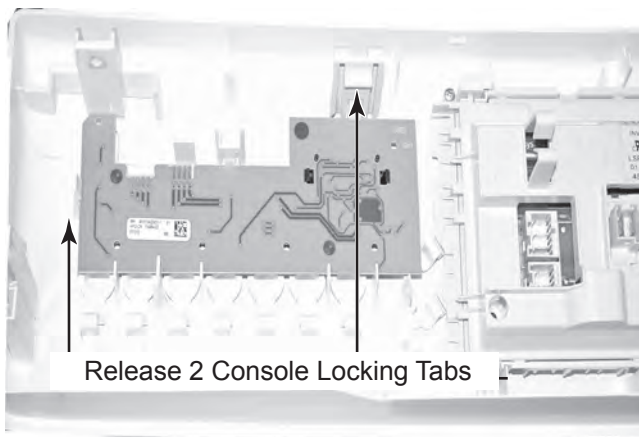

Release 2 Console Locking Tabs



Touchpad/LED Assembly

7. To remove the central control unit:

- a) After removing touchpad/LED assembly, replace central control unit and console as a complete assembly.

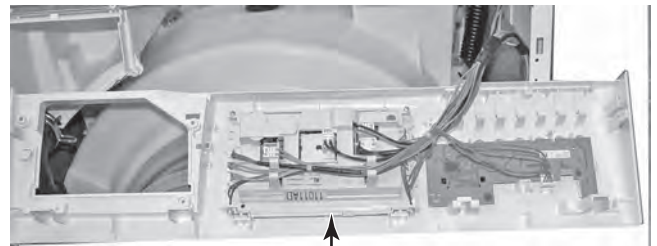

Central Control Unit

REMOVING THE WATER INLET VALVE

⚠️ WARNING



Electrical Shock Hazard

Disconnect power before servicing.

Replace all parts and panels before operating.

Failure to do so can result in death or electrical shock.

1. Unplug washer or disconnect power.
2. Turn off the water supply to the washer.
3. Remove the water hoses from the hot and cold water inlet valve.
4. Remove the top cover (see page 4-2 for the procedure).

Water Inlet Valve



5. Depress the locking tabs (see the top right photo), and pull the wire connectors out of the hot and cold/bleach water inlet valve solenoid terminal holders. Loosen the clamp, and pull the water inlet hose off the water inlet valves.

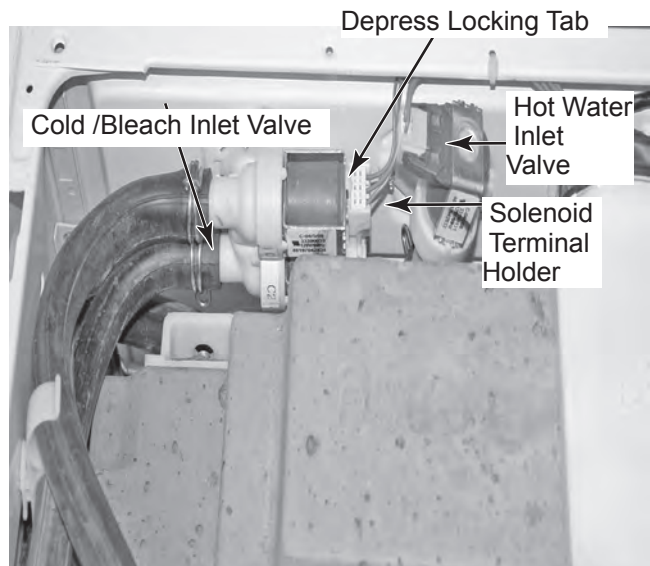

7. At the rear of the washer, remove the screws from the water inlet valve. Rotate the valve to the right, and push it into the washer off the rear panel.

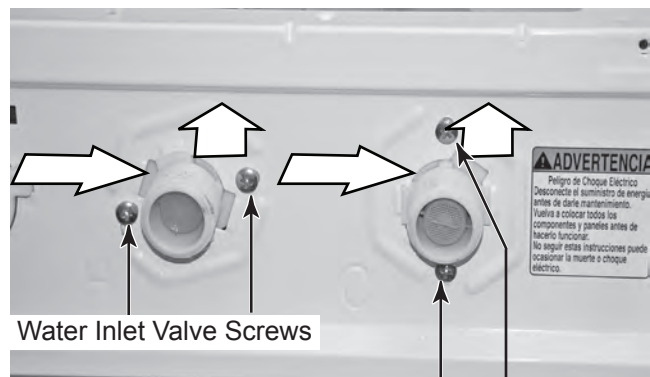

Water Inlet Valve Screws

REMOVING THE PRESSURE SWITCH

⚠ WARNING



Electrical Shock Hazard

Disconnect power before servicing.

Replace all parts and panels before operating.

Failure to do so can result in death or electrical shock.

1. Unplug washer or disconnect power.
2. Turn off the water supply to the washer.
3. Remove the front cover from the washer (see page 4-9 for the procedure).



4. Press and release the two wire connector locking arms and pull the connectors off the pressure switch.
5. Pull the pressure hose off the pressure switch fitting.

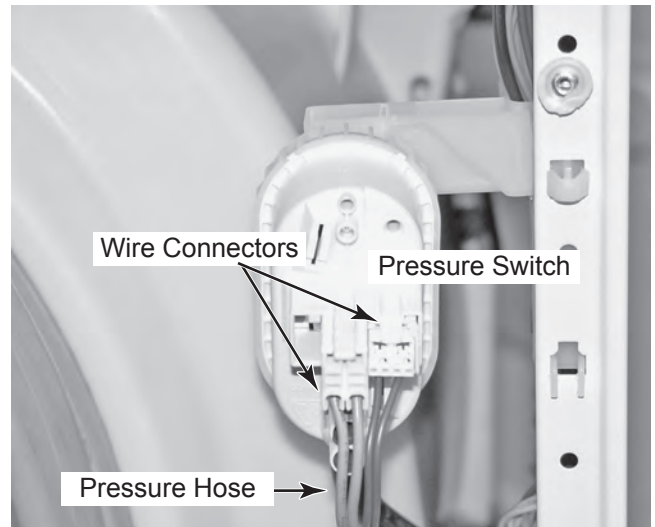

6. Unsnap the pressure switch off the pressure switch holder, then remove the switch from the washer.

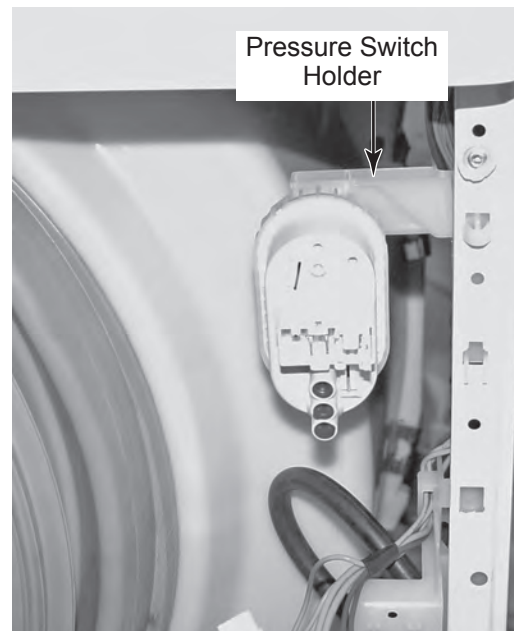

REMOVING THE LINE FILTER & POWER SUPPLY CORD

⚠ WARNING



Electrical Shock Hazard

Disconnect power before servicing.

Replace all parts and panels before operating.

Failure to do so can result in death or electrical shock.

1. Unplug washer or disconnect power.
2. Turn off the water supply to the washer.
3. Remove the top cover from the washer (see page 4-2 for the procedure).

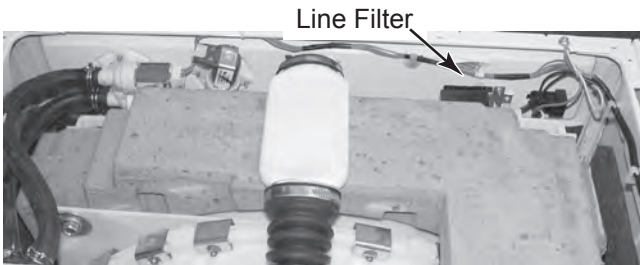

4. **To remove the line filter:**
 - a) Remove the hex-head screws from the line filter.
 - b) Position the line filter so that the four tabs are aligned with the chassis slots and remove the filter from the washer.

Line Filter

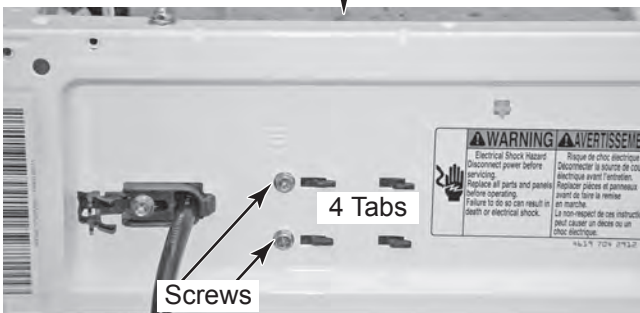

- c) Disconnect the three wire connectors from the line filter. **NOTE:** Press and release the locking arm on the 2-wire connector to disconnect it from the filter.

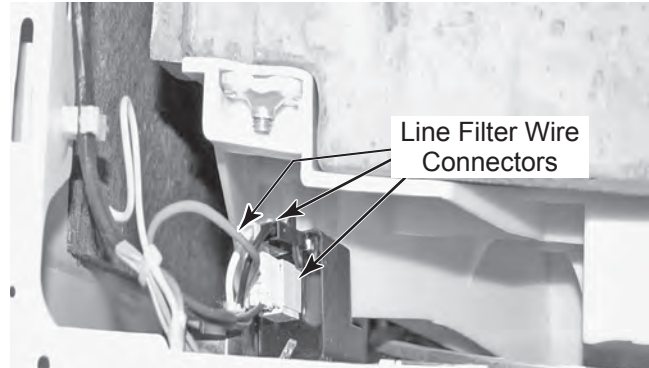

5. **To remove the power supply cord:**

- a) Remove the screw from the green ground wire.
- b) Pull the connectors with the white and black wires from the line filter terminals.

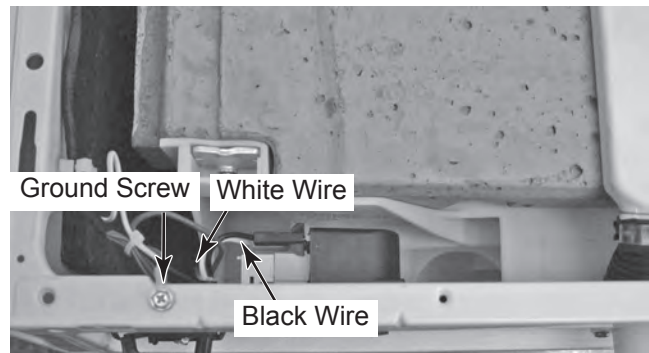

- c) Pull the washer away from the wall far enough to access the power supply cord on the rear panel.
- d) Remove hex head screw to release power supply cord strain relief.

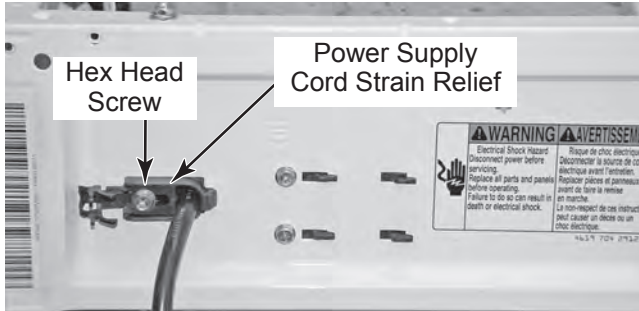

- d) Remove power supply cord strain relief and remove power cord.

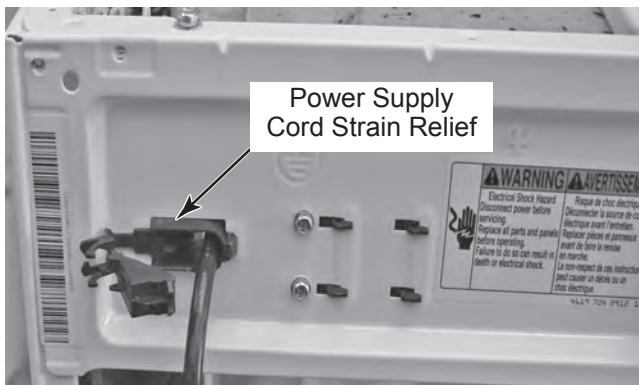

REMOVING THE DETERGENT DISPENSER ASSEMBLY

⚠ WARNING



Electrical Shock Hazard

Disconnect power before servicing.

Replace all parts and panels before operating.

Failure to do so can result in death or electrical shock.

1. Unplug washer or disconnect power.
2. Turn off the water supply to the washer.
3. Remove the top cover from the washer (see page 4-2 for the procedure).

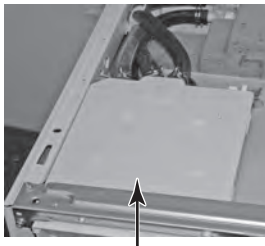

Detergent Dispenser

4. Remove the console from the washer (see step 5 on page 4-2 for the procedure).
5. Loosen the clamp and remove the water feed tube from the dispenser.

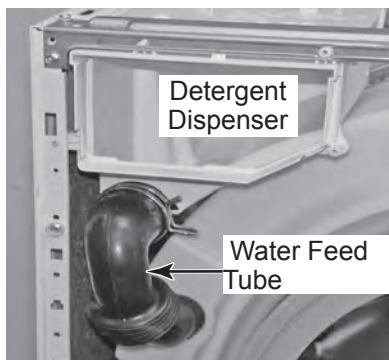

8. Loosen the clamps and remove the water supply tubes from the detergent dispenser.

Note: Take note of hose orientation for reinstallation.

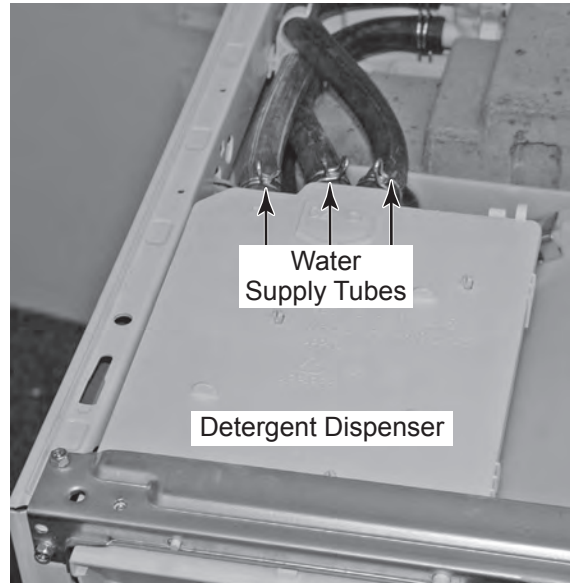

9. Slide the dispenser releasing it from the cabinet frame.

REMOVING THE FRONT PANEL ASSEMBLY

! WARNING



Electrical Shock Hazard
Disconnect power before servicing.
Replace all parts and panels before operating.
Failure to do so can result in death or electrical shock.

1. Unplug washer or disconnect power.
2. Turn off the water supply to the washer.
3. Pry with a coin the lower front access panel, then lower the panel, and remove it.



4. Open the washer door.

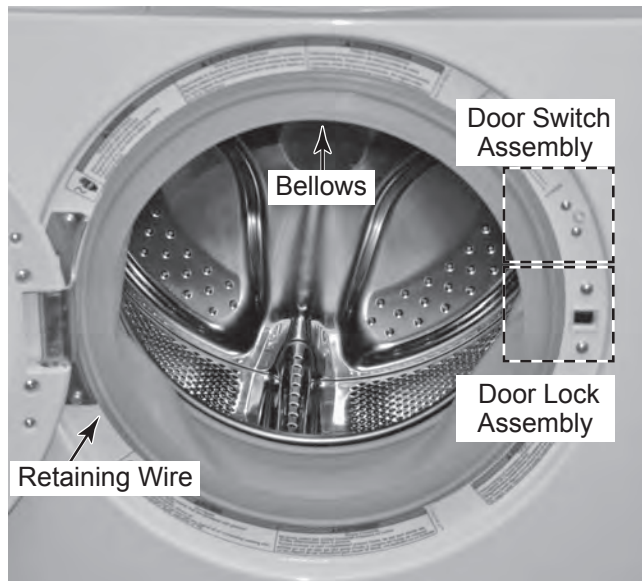

5. Using a small screwdriver or a pair of long-nosed pliers, pull the tension spring on the retaining wire out from around the front of the bellows, and remove the wire.

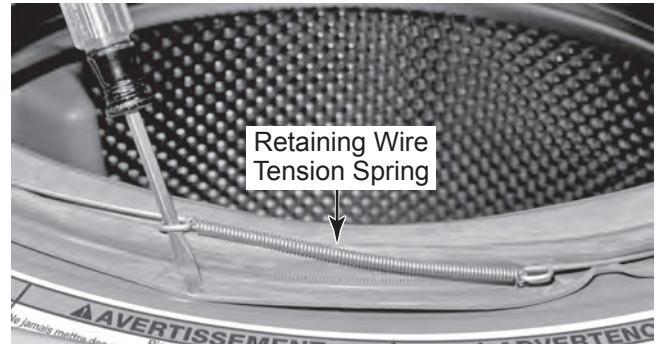

6. Pull the bellows off the lip of the front panel, and push the bellows inside the front panel.
7. Remove the two screws from the door switch assembly and two screws from door lock assembly.

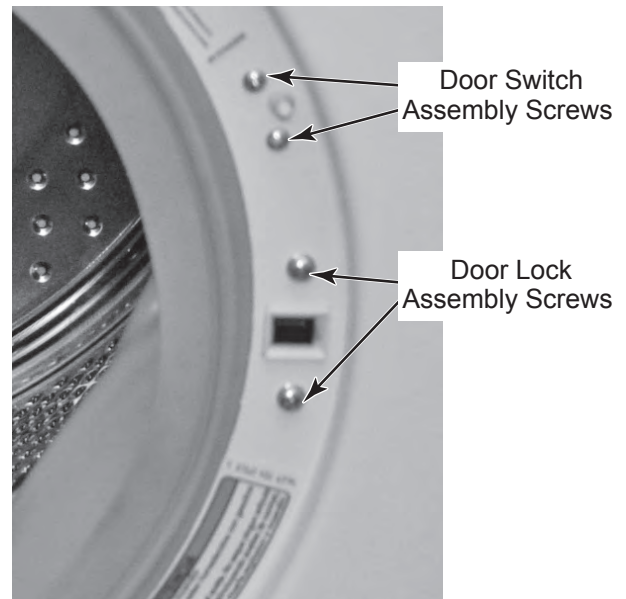

Continued on the next page.

6. Close the washer door.
7. Remove the three hex-head screws from the bottom of the front panel and remove the panel from the unit.

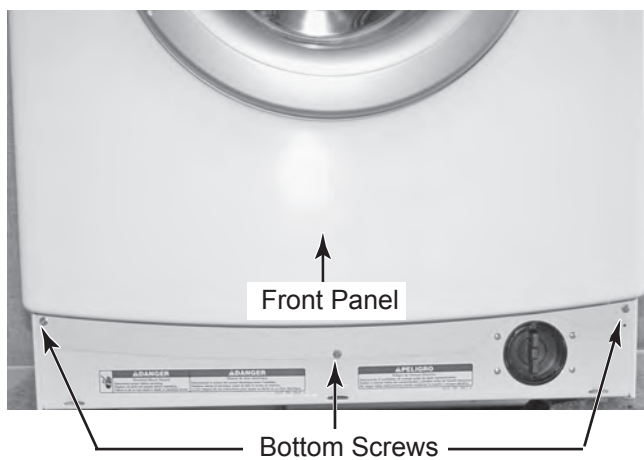

REMOVING THE DOOR SWITCH, DOOR LOCK ASSEMBLY AND THE BELLOWS

⚠ WARNING



Electrical Shock Hazard

Disconnect power before servicing.

Replace all parts and panels before operating.

Failure to do so can result in death or electrical shock.

1. Unplug washer or disconnect power.
2. Turn off the water supply to the washer.
3. Remove the top cover and the console (see page 4-2 for the procedures).
4. Remove the lower front access panel (see step 3 on page 4-9 for the procedure).
5. Open the washer door.

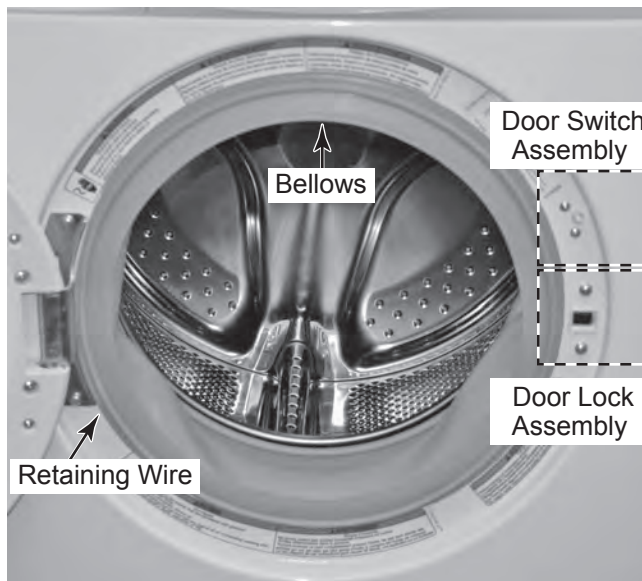

6. Using a small screwdriver or a pair of long-nosed pliers, pull the tension spring on the retaining wire out from around the front of the bellows, and remove the wire.

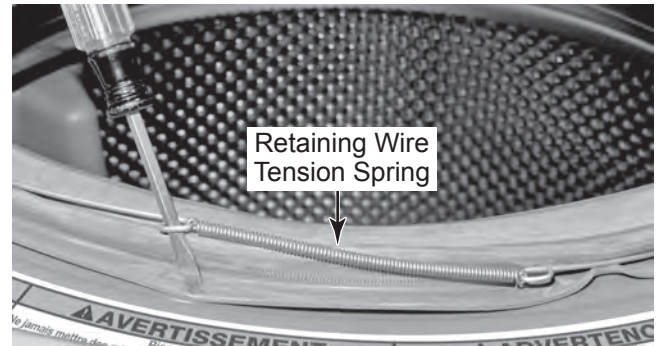

7. **To remove the door switch assembly:**
 - a) Pull the bellows off the lip of the front panel beside the door switch assembly just enough to access the switch assembly.
 - b) Remove the two screws from the door switch assembly and two screws from the door lock assembly.

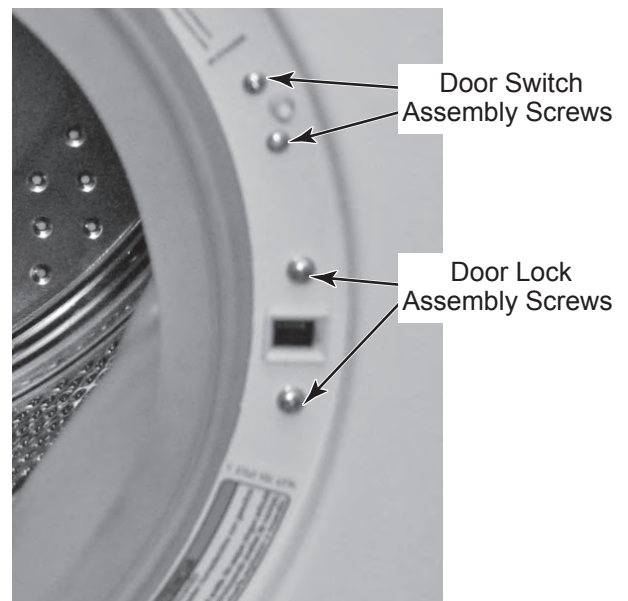

Continued on the next page.

- c) Close the washer door.
- d) Remove the three hex-head screws from the bottom of the front panel and remove the panel from the unit.

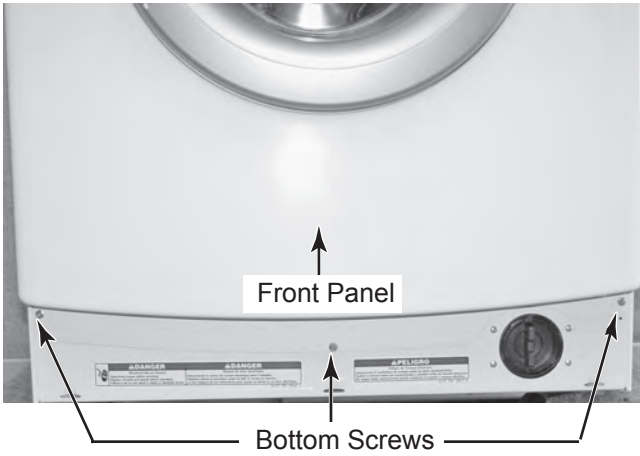

- e) Disconnect the two connectors from the door switch assembly and door lock assembly.

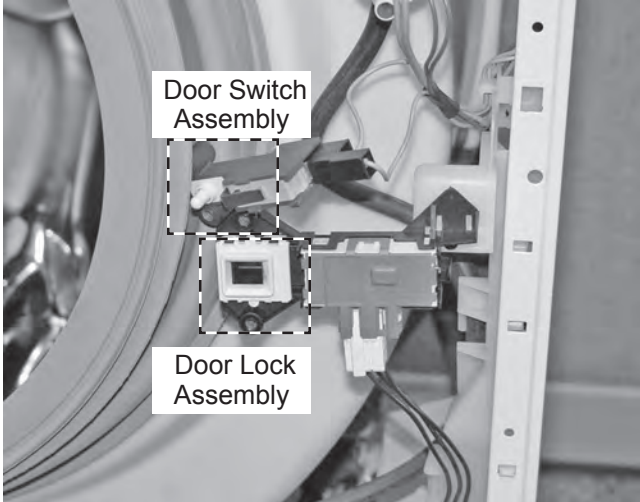

8. **To remove the bellows:**

- a) Remove the two screws from the door switch assembly and door lock assembly (see the photo in step 7b).
- b) Remove the front panel from the washer (see page 4-9 for the procedure).
- c) Turn the bellows retaining clamp screw counterclockwise until the clamp is loose enough to remove it from around the bellows (see the top right photo).
NOTE: It may be necessary to completely remove the screw from one end of the clamp.



d) Remove the bellows retaining clamp from around the bellows.

Remove Bellows Retaining Clamp



e) Pull the bellows off the front of the tub.



REASSEMBLY NOTE: When you reinstall the bellows, be sure to position the “weep holes” at the bottom, as shown below.

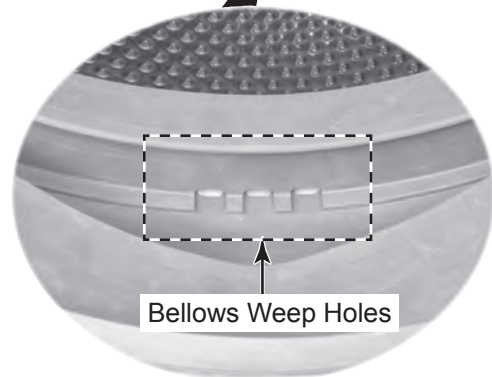

REMOVING THE DRAIN PUMP

⚠ WARNING



Electrical Shock Hazard

**Disconnect power before servicing.
Replace all parts and panels before
operating.**

**Failure to do so can result in death or
electrical shock.**

1. Unplug washer or disconnect power.
2. Turn off the water supply to the washer.
3. Remove the front access panel (see page 4-9 for the procedure).

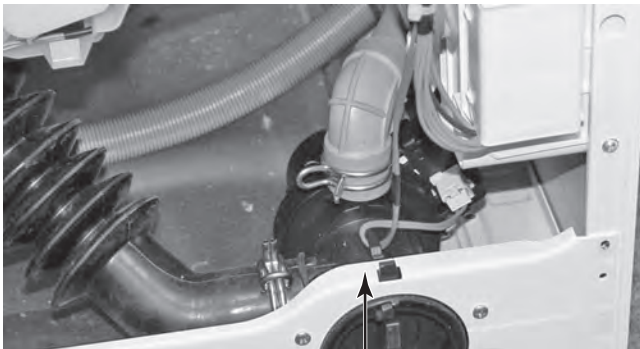

Drain Pump

4. Using a shallow pan to catch the water, unscrew the filter from the drain pump, and drain the water from the pump.

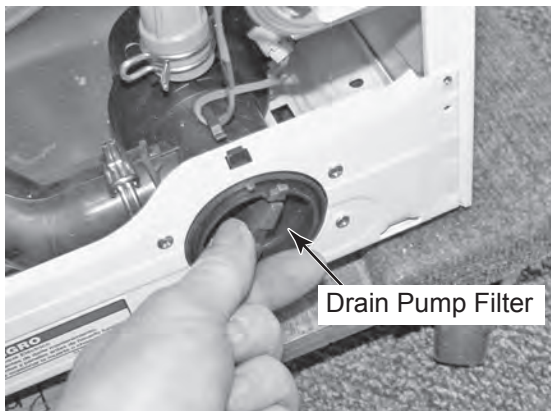

Drain Pump Filter

5. Loosen the clamp and remove the pump-to-tub hose from the drain pump.
6. Loosen the clamp and remove the pump-to-drain hose from the drain pump.

REASSEMBLY NOTE: When you reconnect the pump to tub hose, align the tab(s) with the marks on the drain pump.

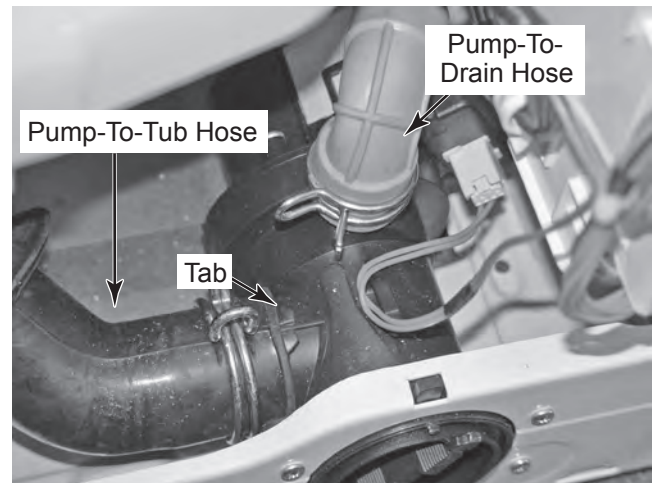

Pump-To-Tub Hose

Pump-To-Drain Hose

Tab

7. Using a philips screwdriver remove the four screws holding the drain pump to the unit .

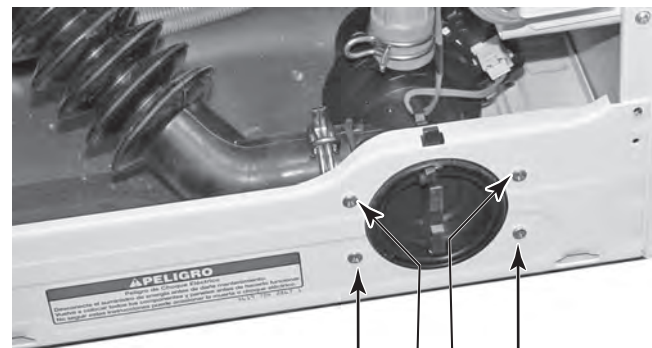

Drain Pump Screws

8. Depress the tab on the wire connector and disconnect the wire connector from the terminals.
9. Remove the wires from the clip, and remove the drain pump from the washer.

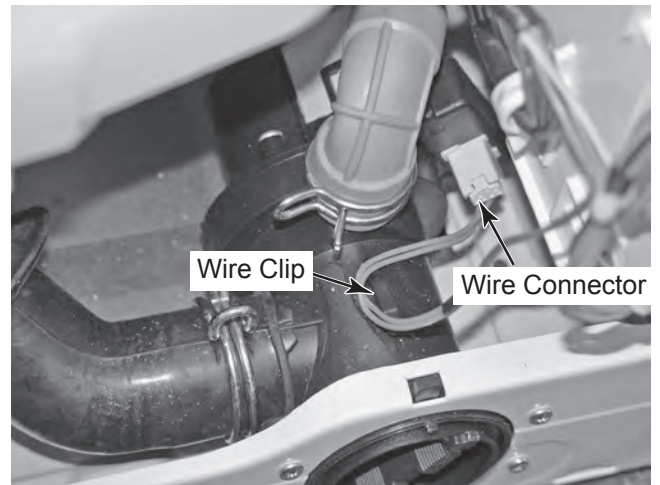

REMOVING THE ECO VALVE

⚠ WARNING



Electrical Shock Hazard

Disconnect power before servicing.

Replace all parts and panels before operating.

Failure to do so can result in death or electrical shock.

1. Unplug washer or disconnect power.
2. Turn off the water supply to the washer.
3. Remove the front access panel (see page 4-9 for the procedure).

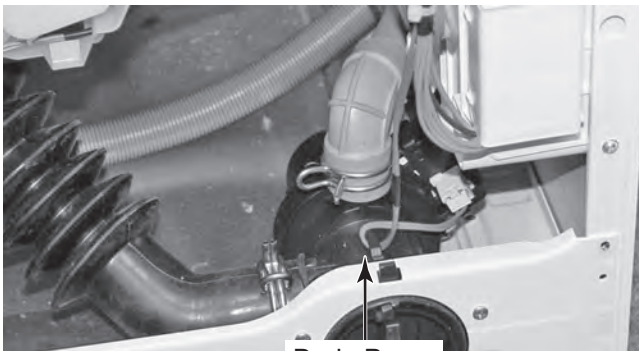

4. Using a shallow pan to catch the water, unscrew the filter from the drain pump, and drain the water from the pump.

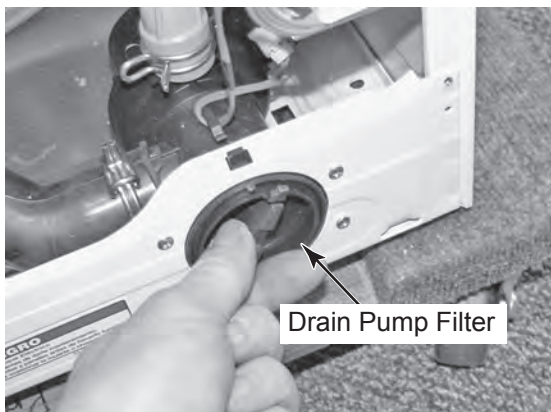

5. Pull the pressure hose off the air trap that is connected to the pump-to-tub/ECO valve hose.
6. Loosen the clamps at both ends of the pump-to-tub hose, and pull the hose/ECO valve off the tub and drain pump.

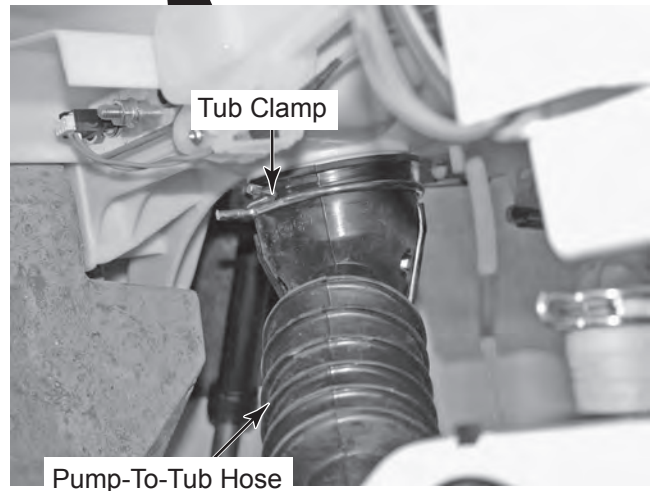
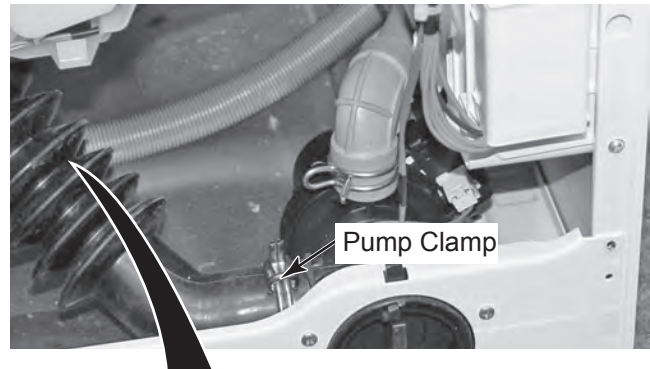

REMOVING THE MOTOR CONTROL UNIT

⚠ WARNING



Electrical Shock Hazard
Disconnect power before servicing.
Replace all parts and panels before operating.
Failure to do so can result in death or electrical shock.

1. Unplug washer or disconnect power.
2. Turn off the water supply to the washer.
3. Remove the front access panel (see page 4-9 for the procedure).

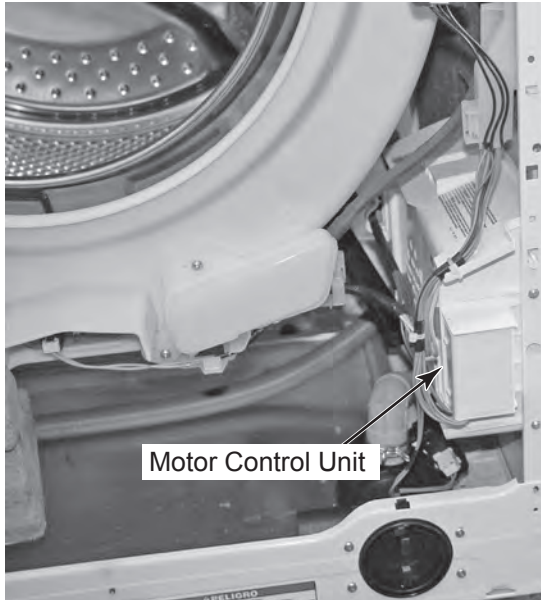

4. Unclip wire harness from motor controller holders.
5. Remove the wire tie from the cover.

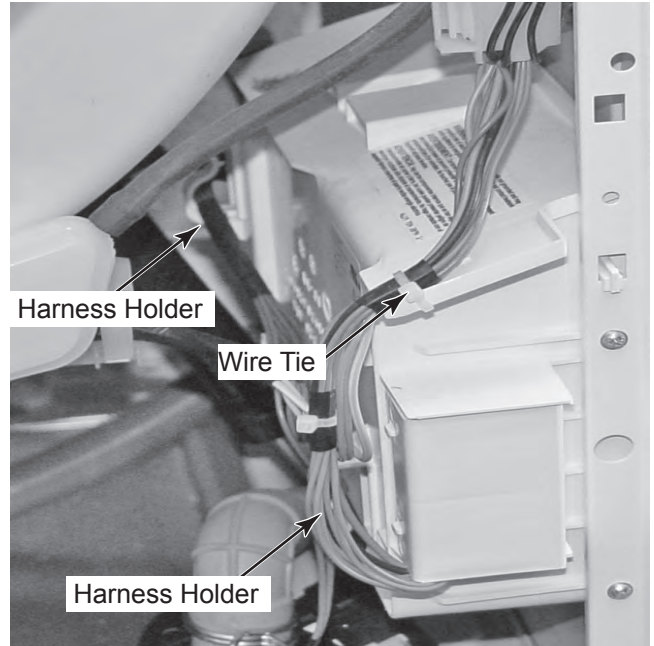

6. Remove two screws holding motor control to unit.

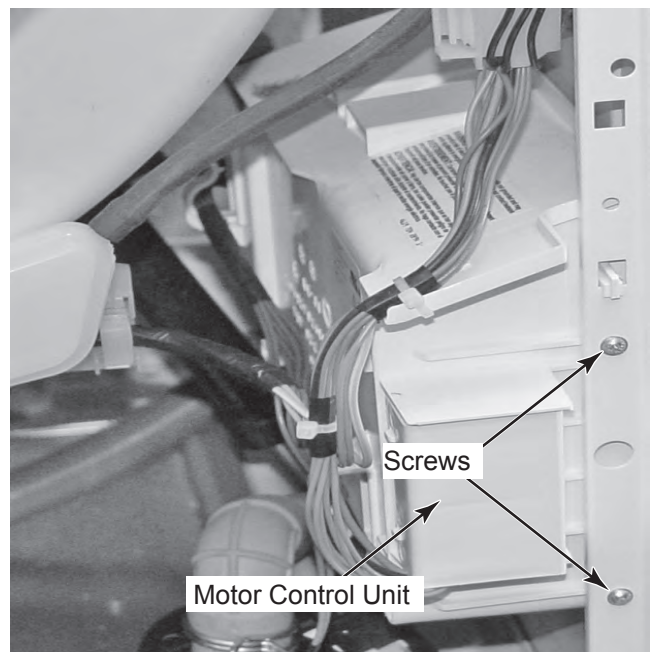

Continued on the next page.

- Slide the motor controller back and out the front.
- Pry with screwdriver the wire cover to expose wire connectors.

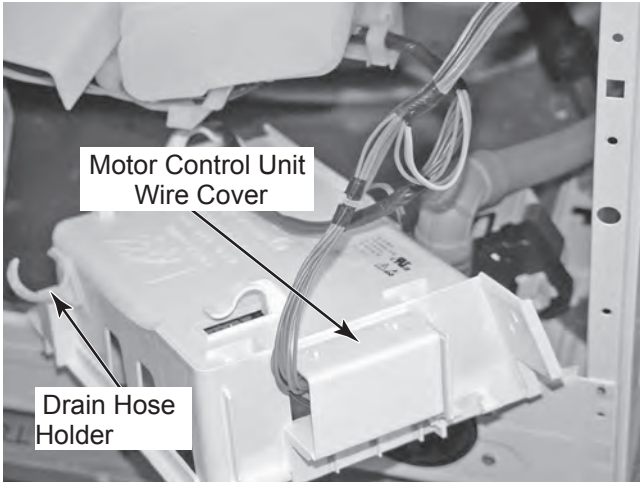

- Push release tabs and release two front wire connectors.

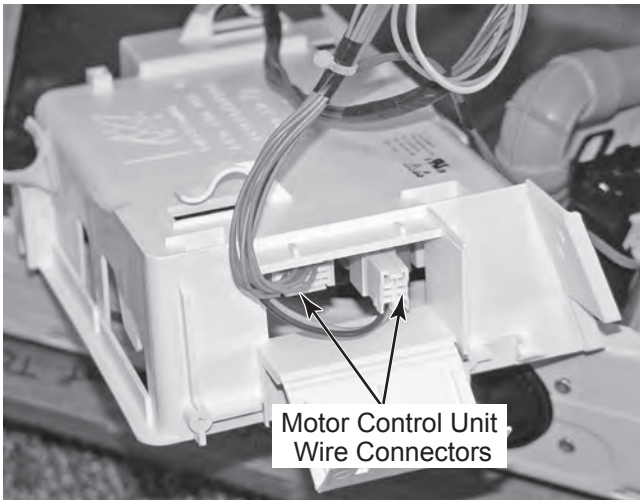

- Rotate motor controller and release tab to one rear wire connector.

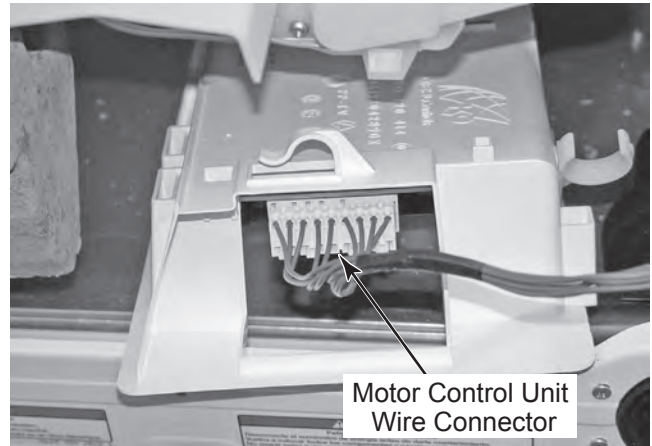

- Remove motor control out of unit.

REMOVING THE TEMPERATURE SENSOR

⚠ WARNING



Electrical Shock Hazard

Disconnect power before servicing.

Replace all parts and panels before operating.

Failure to do so can result in death or electrical shock.

1. Unplug washer or disconnect power.
2. Turn off the water supply to the washer.
3. Remove the front access panel (see page 4-9 for the procedure).

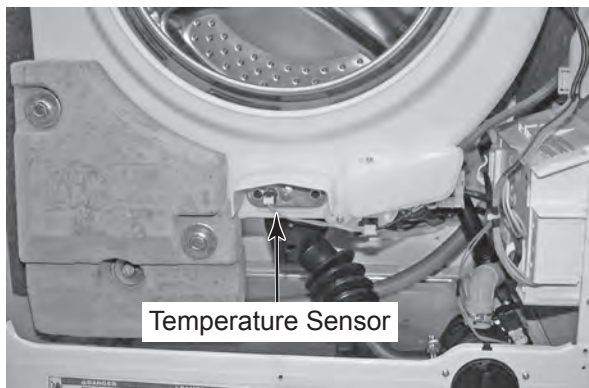

4. Disconnect the wire connector from the temperature sensor.

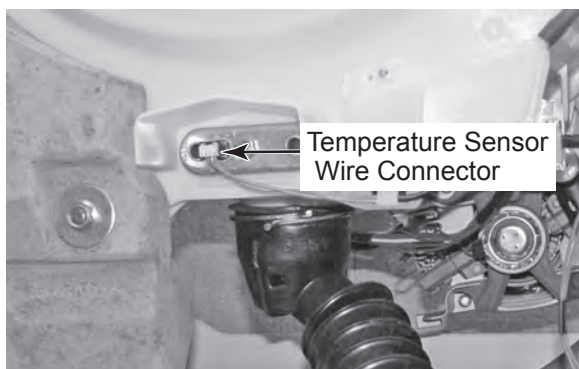

5. Loosen the 10 mm nut and pull the temperature sensor out of mounting bracket.

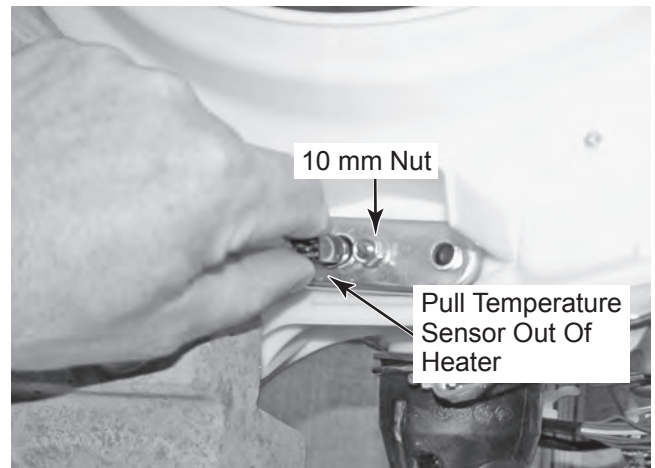

REMOVING THE DRIVE BELT AND MOTOR

⚠ WARNING



Electrical Shock Hazard

Disconnect power before servicing.

Replace all parts and panels before operating.

Failure to do so can result in death or electrical shock.

1. Unplug washer or disconnect power.
2. Turn off the water supply to the washer.
3. Pull the washer away from the wall.
4. Remove the four plastic shipping bolt hole covers. To remove a cover, lift the rounded end to unhook the locking tab from the slot in the chassis, and slide the cover off the rear panel (see the top right photo).
5. Remove the hex-head screws (arrows) from the rear panel.
6. Remove the rear panel.

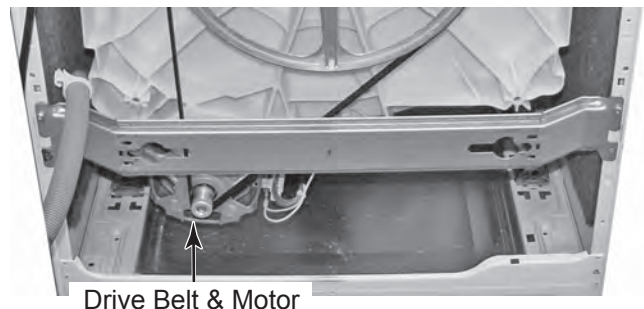
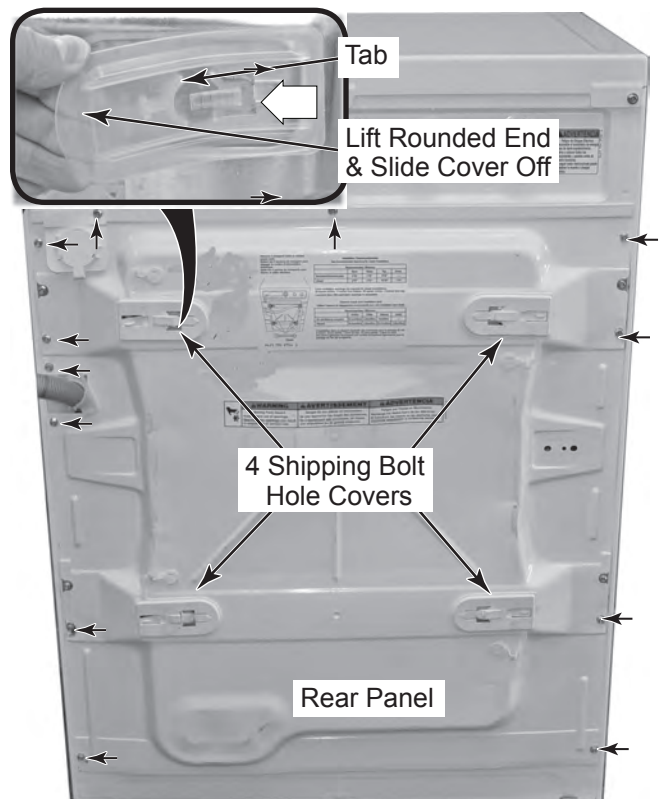

7. **To remove the drive belt**, pull out on the belt, and turn the basket drive pulley until the belt slides off (see the top right photo).

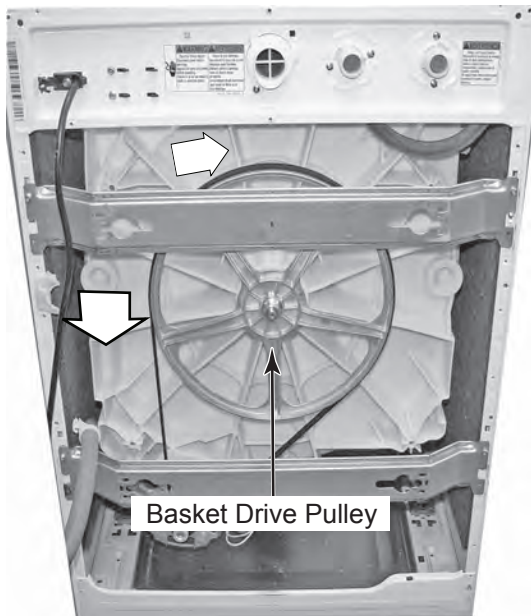

- e) Rotate the motor down and pull it toward you so the bracket studs are out of the tub mounting holes, and remove the motor.

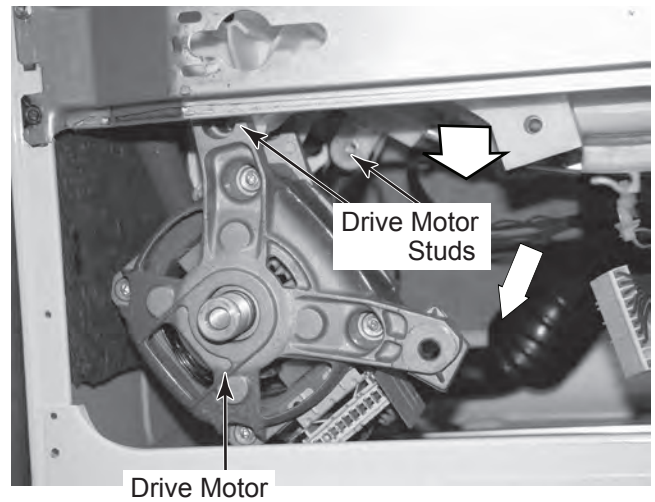

8. **To remove the motor:**

- a) Remove the wire standoff from the motor by squeezing the tabs and pushing the standoff out of the mounting hole.
- b) Disconnect the wire connector from the motor terminals.
- c) Pull ground wire off of motor terminal.
- d) Remove the 13mm mounting bolt from the motor.

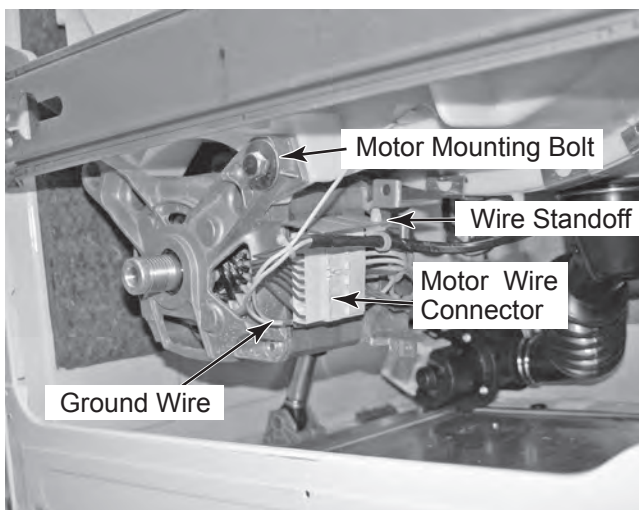

REMOVING THE BASKET DRIVE PULLEY

⚠ WARNING



Electrical Shock Hazard

Disconnect power before servicing.

Replace all parts and panels before operating.

Failure to do so can result in death or electrical shock.

1. Unplug washer or disconnect power.
2. Turn off the water supply to the washer.
3. Pull the washer away from the wall.
4. Remove the rear panel from the washer (see page 4-20 for the procedure).
5. Remove the drive belt from the pulley by rotating the pulley and pulling the belt off (see the top right photo).

6. Use a large screwdriver and lock the pulley, then remove the 15/16" nut from the drive pulley.

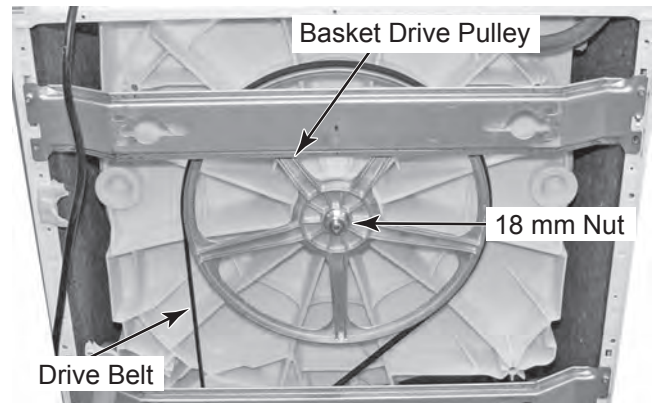

7. Pull the basket drive pulley off the basket shaft and remove it.

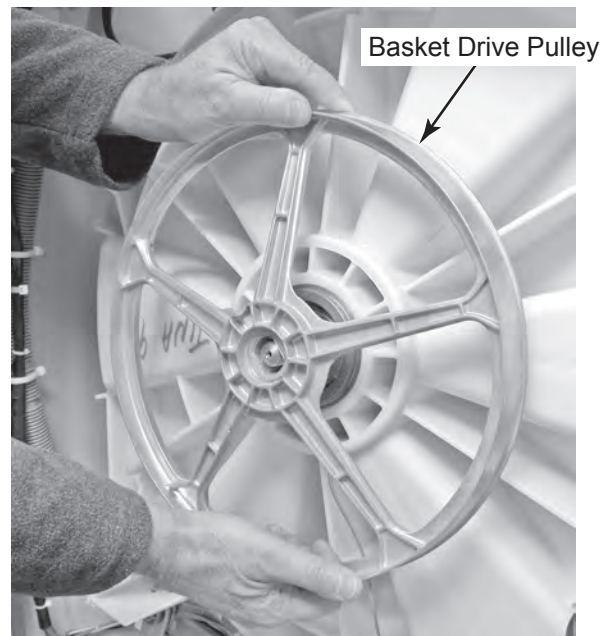

REMOVING THE TUB AND BASKET

⚠ WARNING



Electrical Shock Hazard
Disconnect power before servicing.
Replace all parts and panels before operating.
Failure to do so can result in death or electrical shock.

1. Unplug washer or disconnect power.
2. Turn off the water supply to the washer.
3. Pull the washer away from the wall.
4. Remove the detergent dispenser assembly (see page 4-8 for the procedure).
5. Loosen the clamp and remove the main water feed tube from the detergent dispenser.
6. Pull the free end of the main water feed tube from the tub opening.

REASSEMBLY NOTE: When you reconnect the water feed tube, align the arrow on the tube with the line on the detergent dispenser.

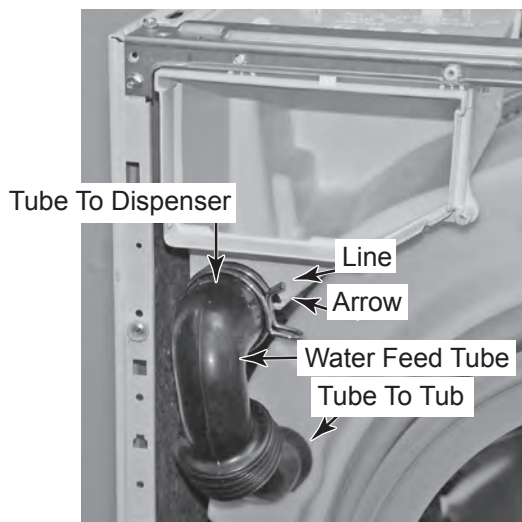

7. Remove the four hex-head screws from the front frame and remove the frame.

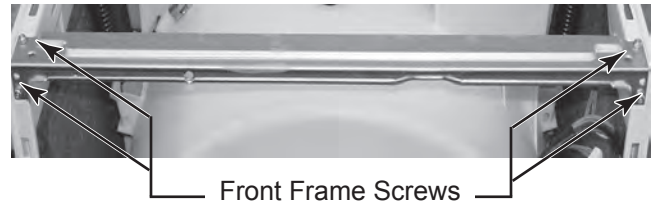

8. Remove the three 13mm bolts from the bottom front weight, then remove the weight from the washer.

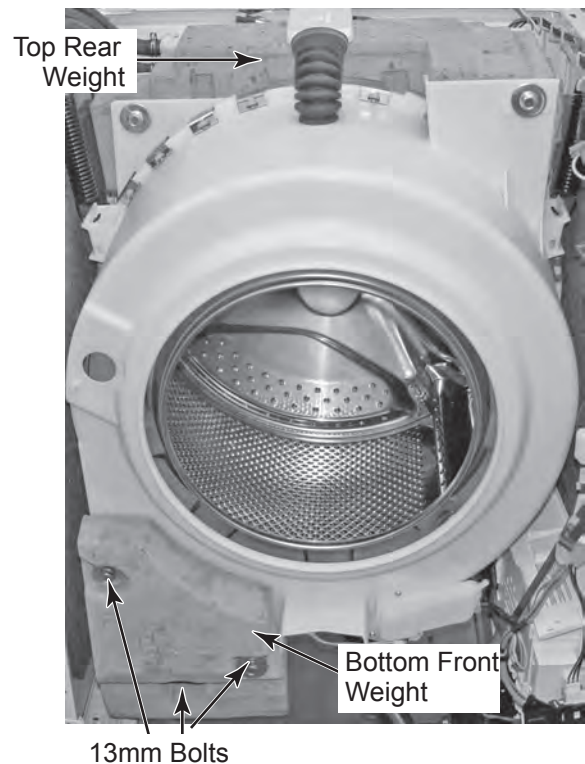

9. Remove hose clamps from top vent hose on each side of plastic rigid vent.

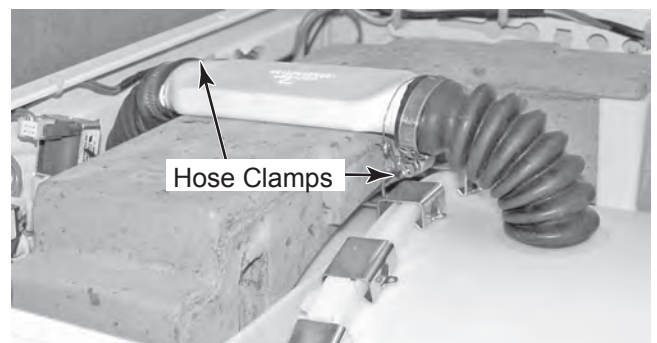

Continued on the next page.

10 Remove the two 13mm bolts from the top rear weight, then remove the weight from the washer.

REASSEMBLY NOTE: When removing top rear weight leave rigid vent attached to it.

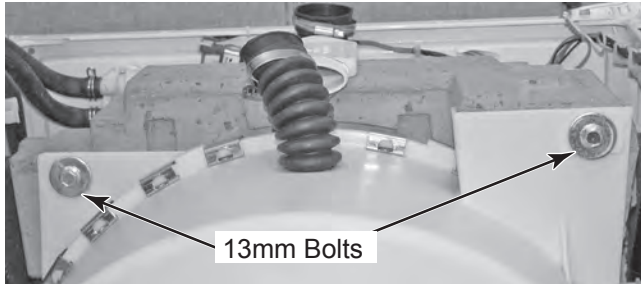

- 11. Remove the bellows from the tub (see pages 4-12 through 4-13 for the procedure).
- 12. Using a shallow pan to catch the water, unscrew the filter from the drain pump, and drain the water from the pump.

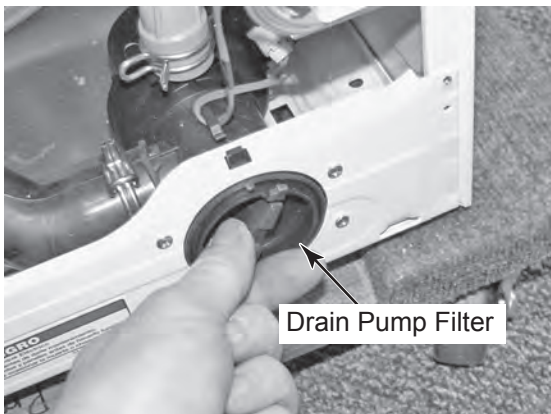

13. Loosen the clamp and remove the pump-to-tub hose from the drain pump.

REASSEMBLY NOTE: When you reconnect the hose, align the tab with the arrow on the drain pump.

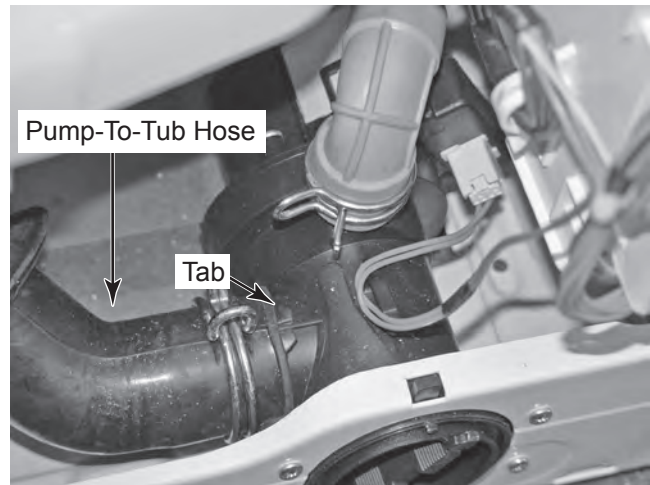

- 14. Remove the rear panel (see page 4-20 for the procedure).
- 15. Remove the basket drive pulley from the basket shaft (see page 4-22 for the procedure).
- 16. Remove ground wire that is connected to the bearing hub, and pull the wire out of the tub holes.

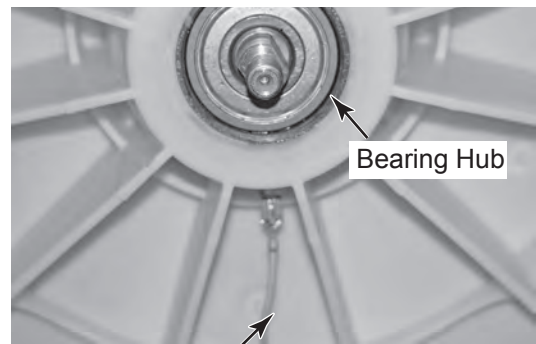

17. Disconnect the pressure hose from the pressure switch.

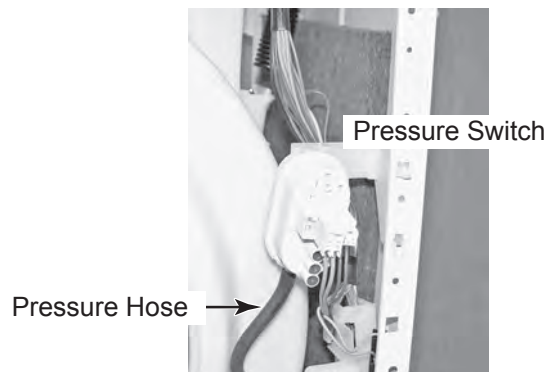

18. Remove the drive motor from the tub (see page 4-20 for the procedure).
19. Remove the temperature sensor and heater from the tub (see page 4-19 for the procedure).
20. Release the two motor control unit wiring standoffs from the tub. Squeeze in on the standoff tabs to release the standoffs.



Motor Control Unit Wiring Standoffs

21. Remove the two shock absorbers from the tub. To remove a shock absorber:
 - a) Remove the locking clips by squeezing the tabs on the locking clips from the base.

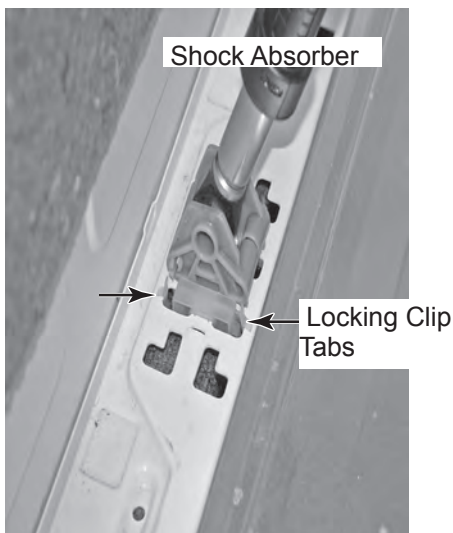

- b) Using a pair of pliers, turn the top of the shock absorber 90° so that the locking tabs align with the slots in the tub, and remove the shock absorber (see the top right photo).

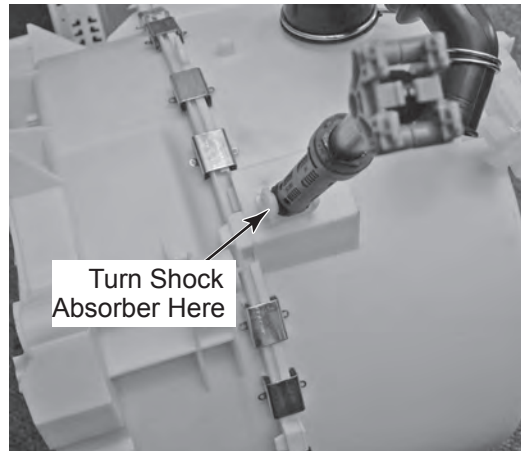

22. Remove the end of the vent tube from the tub.

⚠ WARNING

Excessive Weight Hazard

Use two or more people to move and install washer.

Failure to do so can result in back or other injury.

23. **To remove the tub and basket:**
 - a) Lift the tub and basket assembly and unhook the two suspension springs, then remove the assembly from the washer, and place it front-side down on a padded surface.

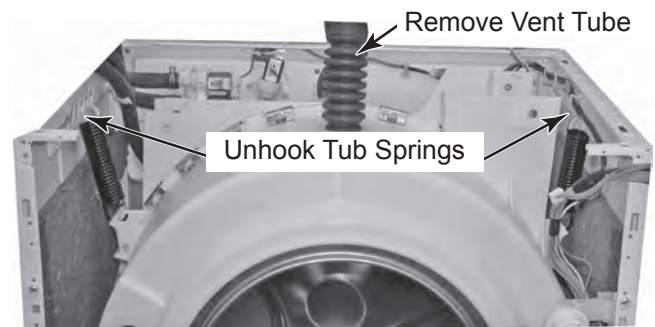

Continued on the next page.

b) Remove the flat nuts from the tub.

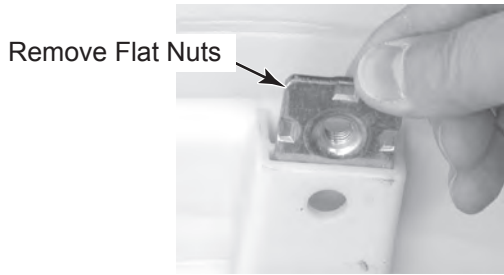

c) Mark the edges of the tub clamps with a pencil to make it easier to reinstall later.

d) Use a large flat-blade screwdriver and pry off the tub clamps.

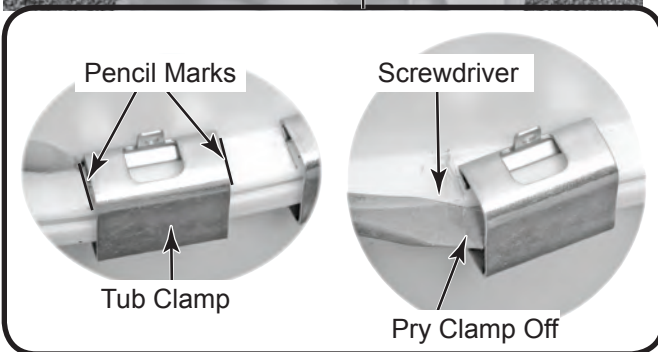
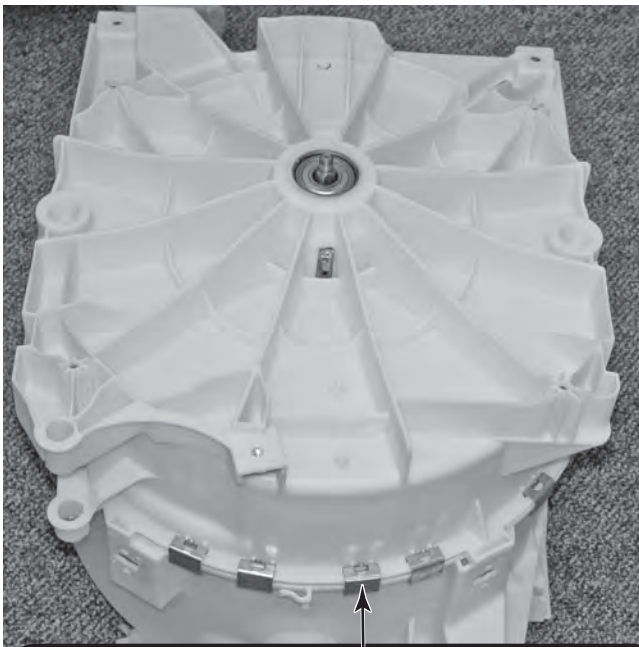

e) Use a large flat-blade screwdriver and pry the tub halves apart, then lift the rear half of the tub off the front half (see the top right photo).

f) Lift the basket from the front half of the tub.

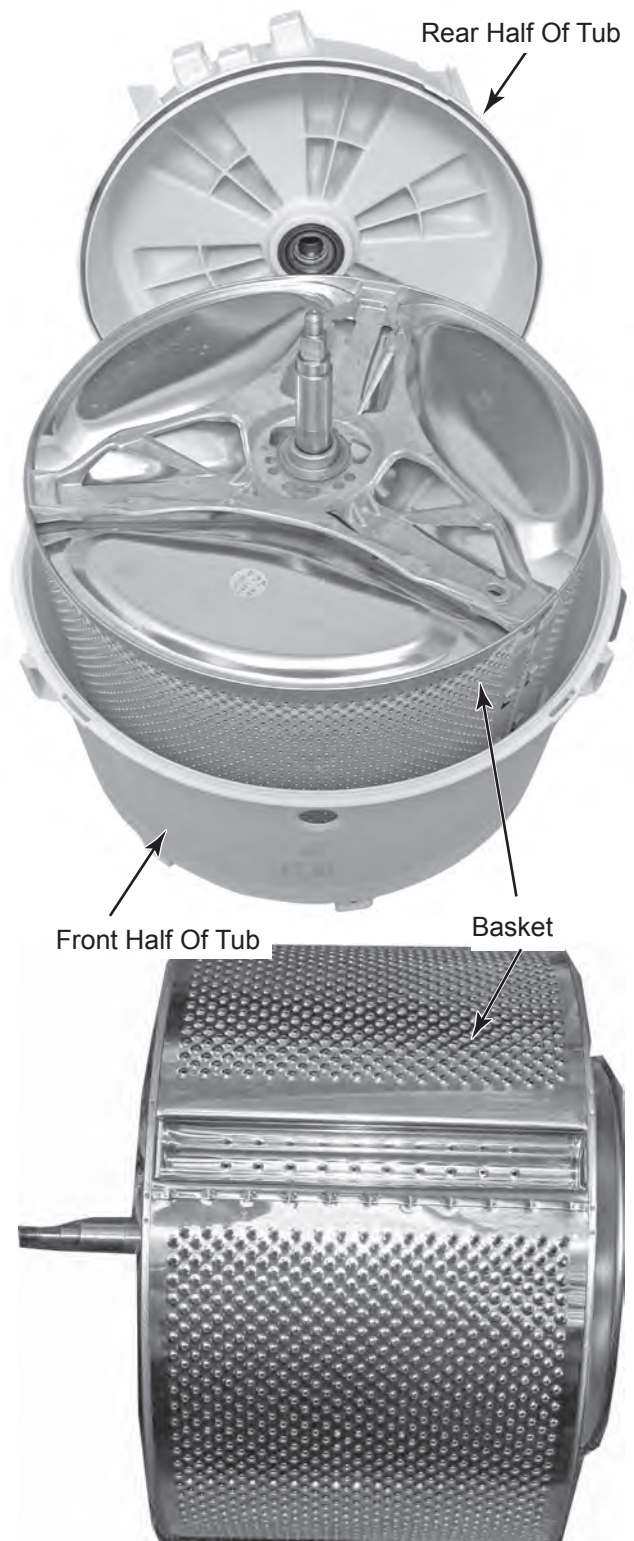

24. To replace the tub gasket, pry the gasket out of the slot, and remove it. **NOTE:** The basket hub is molded into the rear half of the tub. If it is worn and needs to be replaced, replace the rear half of the tub.

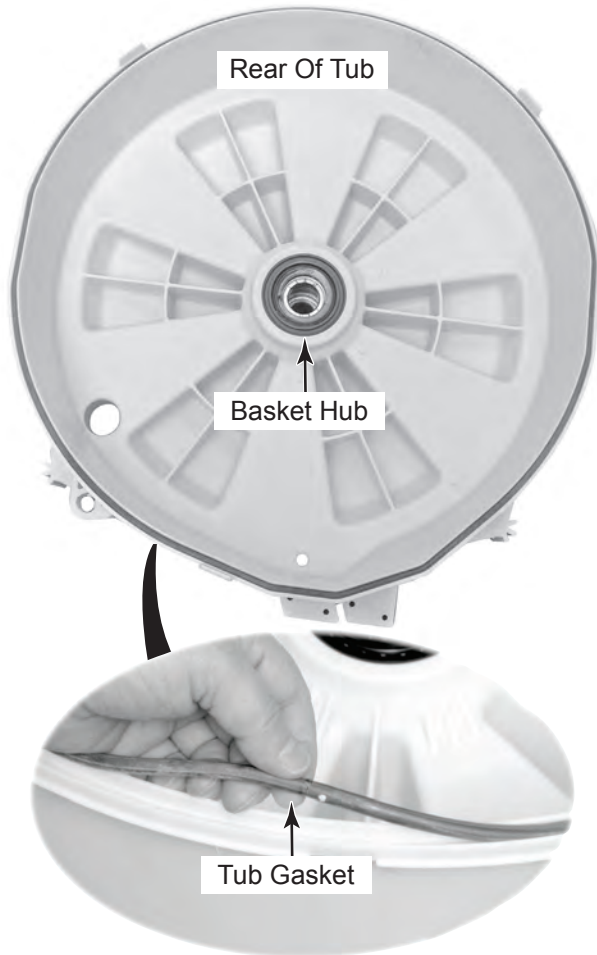

— NOTES —

COMPONENT TESTING

Before testing any of the components, perform the following checks:

- Control failure can be the result of corrosion on connectors. Therefore, disconnecting and reconnecting wires will be necessary throughout test procedures.
- All tests/checks should be made with a VOM or DVM having a sensitivity of 20,000 ohms-per-volt DC, or greater.
- Check all connections before replacing components, looking for broken or loose wires, failed terminals, or wires not pressed into connectors far enough.
- Resistance checks must be made with power cord unplugged from outlet, and with wiring harness or connectors disconnected.
- Unless stated otherwise, make all resistance checks by disconnecting the component connector at the Central Control Unit (CCU).



! WARNING

Electrical Shock Hazard

Disconnect power before servicing.

Replace all parts and panels before operating.

Failure to do so can result in death or electrical shock.

INLET COLD/BLEACH WATER VALVE SOLENOIDS

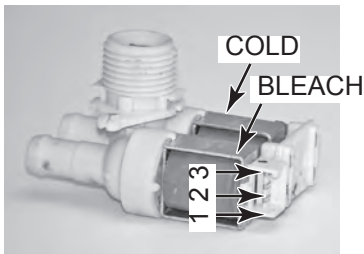

Refer to page 4-6 for the procedure for accessing the inlet cold/bleach water valve.

To check the inlet cold/bleach water valve solenoids at the component terminals, perform the following steps.

1. Unplug washer or disconnect power.
2. Disconnect the solenoid connector from the inlet cold/bleach valve terminals.
3. Set the ohmmeter to the R X 100 scale.
4. Touch the ohmmeter test leads to the 1 and 2 cold water connector terminals. The meter should indicate between 825 and 1115 Ω .
5. Touch the ohmmeter test leads to the 1 and 3 bleach water connector terminals.

The meter should indicate between 825 and 1115 Ω .

To check the inlet valve solenoids at the CCU, perform the following steps.

1. Unplug washer or disconnect power.
2. Disconnect the inlet valve solenoid connector **VPW3 & VW3** (see page 4-5) from the CCU.
3. Set the ohmmeter to the R X 100 scale.
4. Touch the ohmmeter test leads to the following connector pins. The meter should indicate between 825 and 1115 Ω .
 - Pins 1 & 2 (cold)
 - Pins 1 & 3 (bleach)

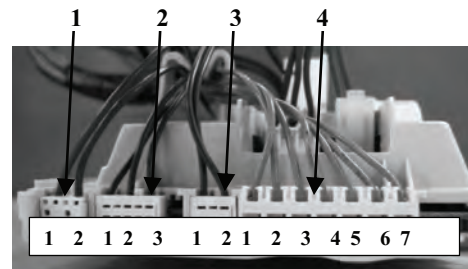

- | | | |
|----|-----------------------|---------------------|
| 1. | DP2 | Drain Pump |
| 2. | VPW3 & VW3 | Cold / Bleach Valve |
| 3. | VHF3 | Hot Valve |
| 4. | M7 | Universal Motor |

INLET HOT WATER VALVE SOLENOID

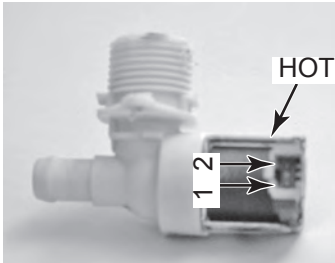

Refer to page 4-6 for the procedure for accessing the inlet hot water valve.

To check the inlet hot water valve solenoids at the component terminals, perform the following steps.

1. Unplug washer or disconnect power.
2. Disconnect the hot water solenoid connector from the inlet hot water valve terminals.
3. Set the ohmmeter to the R X 100 scale.
4. Touch the ohmmeter test leads to the hot water connector terminals. The meter should indicate between 825 and 1115 Ω .

To check the inlet hot water valve solenoid at the CCU, perform the following steps.

1. Unplug washer or disconnect power.
2. Disconnect the inlet hot water valve solenoid connector **VHF3** (see page 4-5) from the CCU.
3. Set the ohmmeter to the R X 100 scale.
4. Touch the ohmmeter test leads to the following connector pins. The meter should indicate between 825 and 1115 Ω .
 - Pins 1 & 2 (hot)

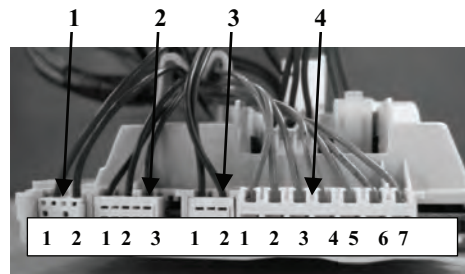

- | | | |
|----|-----------------------|---------------------|
| 1. | DP2 | Drain Pump |
| 2. | VPW3 & VW3 | Cold / Bleach Valve |
| 3. | VHF3 | Hot Valve |
| 4. | M7 | Universal Motor |



⚠ WARNING

Electrical Shock Hazard

**Disconnect power before servicing.
Replace all parts and panels before operating.
Failure to do so can result in death or electrical shock.**

PRESSURE SWITCH

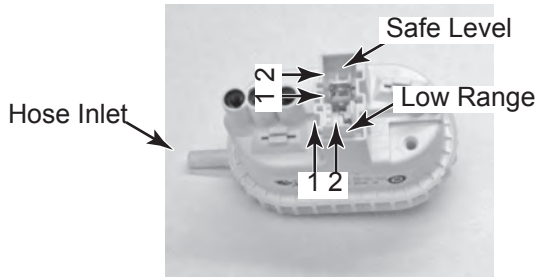

Refer to page 4-7 for the procedure for accessing the pressure switch.

To check the pressure switch contacts at the component terminals, perform the following steps.

1. Unplug washer or disconnect power.
2. Disconnect the wire connectors and hose from the pressure switch.
3. Set the ohmmeter to the R X 1 scale.
4. Touch the ohmmeter test leads to the pressure switch connector pins shown below. Blow into the hose inlet of the pressure switch to activate the diaphragm. The meter should indicate 0 Ω for each measurement while the diaphragm is activated.

<u>Water Level Setting</u>	<u>Test Points</u>
Safe Level	Pins 1 and 2
Low Range	Pins 1 and 2

To check the pressure switch at the CCU, perform the following steps.

1. Unplug washer or disconnect power.
2. Disconnect pressure switch connector **PRS2** (see page 4-5) from the CCU.
3. Set the ohmmeter to the R X 1 scale.
4. Touch the ohmmeter test leads to connector pins 1 and 2 on PRS2. The meter should indicate 0 Ω.

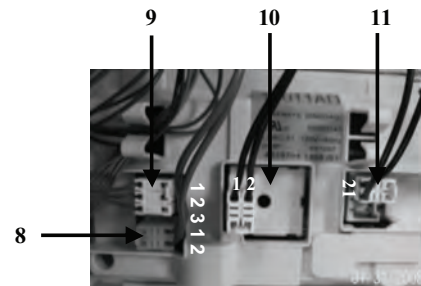

8. **MS2** Motor Supply
9. **DLS3** Door Lock
10. **IF2** RFI filter
11. **PRS2** Safety level of Pressure switch

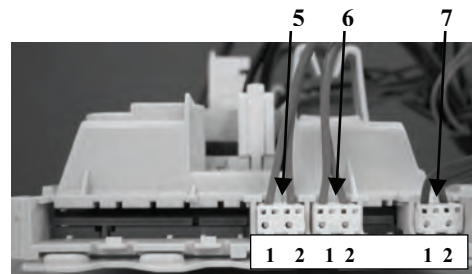

5. **SET2** Temperature Sensor
6. **DU3** Door Switch
7. **PR2** Pressure switch Input low voltage

- 4a. Touch the ohmmeter test leads to connector pins 1 and 2 on PR2. The meter should indicate 0 Ω.

⚠ WARNING



Electrical Shock Hazard

Disconnect power before servicing.
Replace all parts and panels before operating.
Failure to do so can result in death or electrical shock.

LINE FILTER

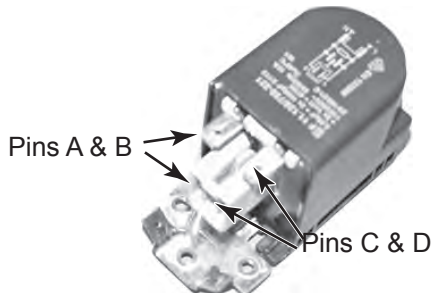

Refer to page 4-8 for the procedure for accessing the line filter.

To check the line filter at the component terminals, perform the following steps.

1. Unplug washer or disconnect power.
2. Disconnect the wire connectors from the line filter.
3. Set the ohmmeter to the R X 1 scale.
4. Touch the ohmmeter test leads to the following connector pins (shown above). The meter should indicate 0 Ω for each measurement.

Pins A and B
Pins C and D

To check the line filter at the CCU, perform the following steps.

1. Unplug washer or disconnect power.
2. Disconnect the line filter connector **IF2** (see page 4-5) from the CCU.
3. Set the ohmmeter to the R X 1 scale.
4. Touch the ohmmeter test leads to connector pins 1 and 2. The meter should indicate 0 Ω .

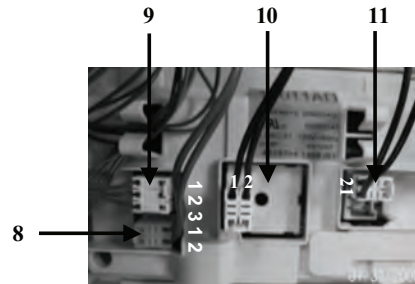

- | | | | |
|----------------|--------------|-----------------|---------------------------------|
| 8. MS2 | Motor Supply | 10. IF2 | RFI filterDoor Switch |
| 9. DLS3 | Door Lock | 11. PRS2 | Safety level of Pressure switch |



⚠ WARNING

Electrical Shock Hazard

Disconnect power before servicing.
Replace all parts and panels before operating.
Failure to do so can result in death or electrical shock.

DOOR SWITCH

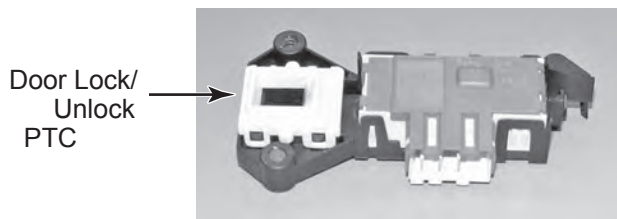
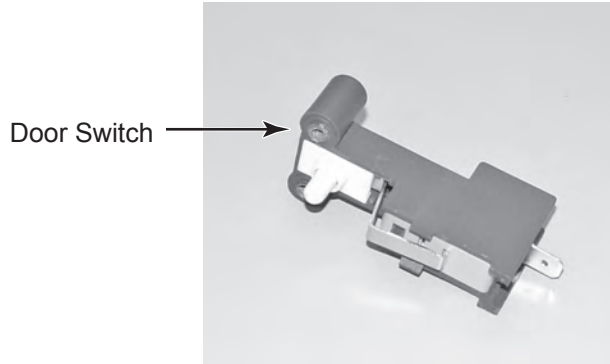

Refer to page 4-14 for the procedure for accessing the door switch.

To check the door switch at the CCU, perform the following steps.

1. Unplug washer or disconnect power.
2. Disconnect the door lock/unlock solenoids connector **DLS3** (see page 4-5) from the CCU.
3. Set the ohmmeter to the R X 1 scale.
4. To test the door lock/unlock solenoids, touch the ohmmeter test leads to the indicated pins on connector **DLS3**. The meter should indicate as follows:

Door Unlock Solenoid - Pins 1 & 2 = infinite

Door Lock Solenoid - Pins 2 & 3 = infinite

Pins 1 & 3 = 1-5 Ω

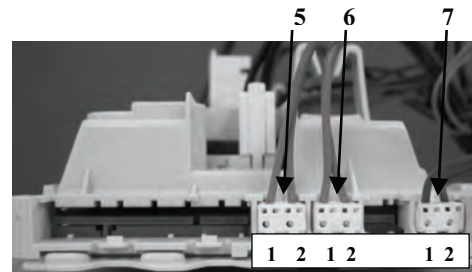

- 5. **SET2** Temperature Sensor
- 6. **DU3** Door Switch
- 7. **PR2** Pressure switch Input low voltage

5. Disconnect the door switch connector **DU3** (see page 4-5) from the CCU.
6. To test the door switch, touch the ohmmeter test leads to pins 1 and 2 at **DU3**. The meter should indicate as follows:

Door Closed = 0 Ω

Door Open = infinite

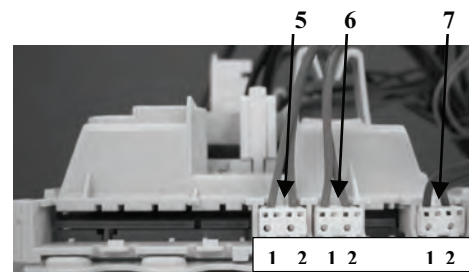

- 5. **SET2** Temperature Sensor
- 6. **DU3** Door Switch
- 7. **PR2** Pressure switch Input low voltage



⚠ WARNING

Electrical Shock Hazard

Disconnect power before servicing.
Replace all parts and panels before operating.
Failure to do so can result in death or electrical shock.

DRAIN PUMP

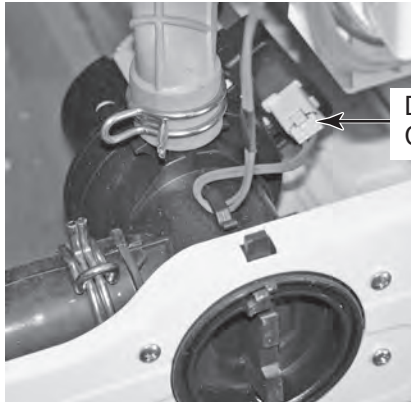

Drain Pump Connector

Refer to page 4-17 for the procedure for accessing the drain pump.

To check the drain pump at the component terminals, perform the following steps.

1. Unplug washer or disconnect power.
2. Disconnect the wire connector from the drain pump.
3. Set the ohmmeter to the R X 1 scale.
4. Touch the ohmmeter test leads to the drain pump terminals. The meter should indicate approximately 28 Ω .

To check the drain pump at the CCU, perform the following steps.

1. Unplug washer or disconnect power.
2. Disconnect the drain pump connector **DP2** (see page 4-5) from the CCU.
3. Set the ohmmeter to the R X 1 scale.
4. Touch the ohmmeter test leads to connector pins 1 and 2. The meter should indicate approximately 28 Ω .

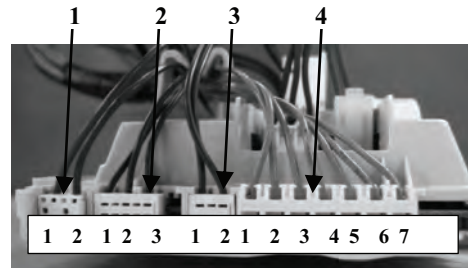

- | | | |
|----|-----------------------|---------------------|
| 1. | DP2 | Drain Pump |
| 2. | VPW3 & VW3 | Cold / Bleach Valve |
| 3. | VHF3 | Hot Valve |
| 4. | M7 | Universal Motor |



⚠ WARNING

Electrical Shock Hazard

**Disconnect power before servicing.
Replace all parts and panels before operating.
Failure to do so can result in death or electrical shock.**

TEMPERATURE SENSOR

Temperature Sensor



Refer to page 4-22 for the procedure for accessing the temperature sensor .

To check the temperature sensor at the component terminals, perform the following steps.

1. Unplug washer or disconnect power.
2. Disconnect the wire connector from the temperature sensor or heater.
3. Set the ohmmeter to the R X 1K scale.
4. To check the temperature sensor, touch the ohmmeter test leads to the sensor terminals. The meter should indicate as shown in the chart below.

Temperature	Results
32°F (0°C)	35.9k Ω
86°F (30°C)	9.7k Ω
104°F (40°C)	6.6k Ω
122°F (50°C)	4.6k Ω
140°F (60°C)	3.2k Ω
158°F (70°C)	2.3k Ω
203°F (95°C)	1k Ω

To check the temperature sensor at the CCU, perform the following steps.

1. Unplug washer or disconnect power.
2. Disconnect the temperature sensor connector **SET2** (see page 4-5) from the CCU.
3. Set the ohmmeter to the R X 1K scale.
4. Touch the ohmmeter test leads to connector pins 1 and 2. The meter should indicate as shown in the chart below.

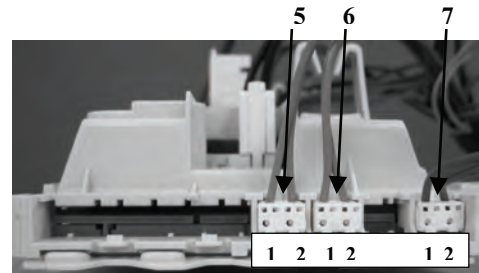

- 5. **SET2** Temperature Sensor
- 6. **DU3** Door Switch
- 7. **PR2** Pressure switch Input low voltage

Temperature	Results
32°F (0°C)	35.9k Ω
86°F (30°C)	9.7k Ω
104°F (40°C)	6.6k Ω
122°F (50°C)	4.6k Ω
140°F (60°C)	3.2k Ω
158°F (70°C)	2.3k Ω
203°F (95°C)	1k Ω



⚠ WARNING

Electrical Shock Hazard

Disconnect power before servicing.
Replace all parts and panels before operating.
Failure to do so can result in death or electrical shock.

DRIVE MOTOR

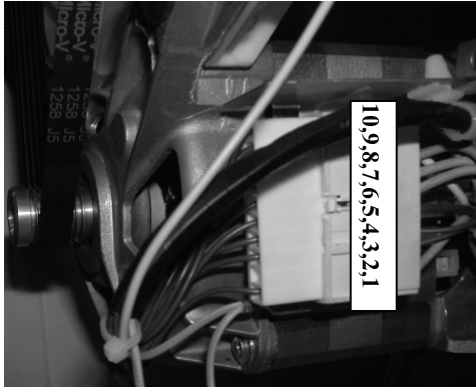

PINS	RESULTS
1 to 5 High speed Stator	Normal = approx. 0.2 ohms
5 to 10 Low Speed Stator	Normal = approx. 1.1 ohms
6 to 7 protector	Normal = approx. 0 ohms
3 to 4 tach	Normal = approx. 68 ohms
8 to 9 brusher	Normal = approx. 0.95 ohms

Refer to page 4-23 for the procedure for accessing the drive motor.

1. Unplug washer or disconnect power.
2. Disconnect the connector from the drive motor.
3. Set the ohmmeter to the R X 1 scale.
4. Touch the ohmmeter test leads to the following motor pins. For each measurement, use the following table.

DIAGNOSTICS & TROUBLESHOOTING

DIAGNOSTICS

DIAGNOSTIC GUIDE

Before servicing, check the following:

- Make sure there is power at the wall outlet.
 - Has a household fuse blown or circuit breaker tripped? Time delay fuse?
 - Are both hot and cold water faucets open and water supply hoses unobstructed?
 - All tests/checks should be made with a VOM or DVM having a sensitivity of 20,000 ohms per volt DC or greater.
 - Check all connections before replacing components. Look for broken or loose wires, failed terminals, or wires not pressed into connections far enough.
- A potential cause of a control not functioning is corrosion on connections. Observe connections and check for continuity with an ohmmeter.
 - Connectors: Look at top of connector. Check for broken or loose wires. Check for wires not pressed into connector far enough to engage metal barbs.
 - Resistance checks must be made with power cord unplugged from outlet, and with wiring harness or connectors disconnected.

FAILURE CODES



! WARNING

Electrical Shock Hazard

**Disconnect power before servicing.
Replace all parts and panels before operating.
Failure to do so can result in death or electrical shock.**

DISPLAY AFFICHAGE	EXPLANATION AND RECOMMENDED PROCEDURE
A09	NO WATER DETECTED ENTERING MACHINE OR PRESSURE SWITCH TRIP NOT DETECTED
	<p>Water level is not reached within a defined time in normal wash cycle.</p> <p>Possible Causes/Procedure</p> <p>If there is no water in the unit:</p> <ul style="list-style-type: none"> - Make sure that both valves at the water source(s) are turned on all the way. - Check for plugged or kinked inlet hoses or plugged screens in the inlet valves. - Verify inlet valve operation. <p>If there is water in the unit:</p> <ul style="list-style-type: none"> - Verify drain pump operation. - Remove hose from pressure switch. Dislodge any debris build up in the hose inside the outer tub. - Verify that the pressure switch hose is in good condition and properly connected to tub and pressure switch. <ol style="list-style-type: none"> 1. Verify there is not a siphon problem. 2. Unplug washer or disconnect power. 3. Verify wire harness connections to inlet valves, pressure switch, drain pump and Central Control Unit (CCU). 4. Check all hoses for possible leaks. 5. Plug in washer or reconnect power 6. Verify pressure switch operation. 7. Verify CCU operation by running a Quick Diagnostic Test or any cycle
A10	LONG DRAIN
	<p>If the drain time exceeds 4 minutes the water valves turn off.</p> <p>NOTES: Rotate knob to clear the display.</p> <p>Possible Causes/Procedure</p> <ol style="list-style-type: none"> 1. Check the drain hose and make sure it is not plugged or kinked . 2. Unplug washer or disconnect power. 3. Remove hose from pressure switch. Dislodge any debris build up in the hose inside the outer tub. 4. Check the electrical connections at the pump and make sure the pump is running. 5. Check the drain pump filter for foreign objects. 6. Plug in washer or reconnect power . 7. If the above does not correct the problem, go to step 8. 8. Unplug washer or disconnect power. 9. Replace the pump.

F01	NO WATER DETECTED ENTERING MACHINE OR PRESSURE SWITCH TRIP NOT DETECTED
	Water level is not reached within a variable time (EEPROM parameter) in whirlpool factory test
	<p>Possible Causes/Procedure</p> <p>If there is no water in the unit:</p> <ul style="list-style-type: none"> - Make sure that both valves at the water source(s) are turned on all the way. - Check for plugged or kinked inlet hoses or plugged screens in the inlet valves. - Verify inlet valve operation. <p>If there is water in the unit:</p> <ul style="list-style-type: none"> - Verify drain pump operation. - Verify that the pressure switch hose is in good condition and properly connected to tub and pressure switch. - Remove hose from pressure switch. Dislodge any debris build up in the hose inside the outer tub. <ol style="list-style-type: none"> 1. Verify there is not a siphon problem. 2. Unplug washer or disconnect power. 3. Verify wire harness connections to inlet valves, pressure switch, drain pump and Central Control Unit (CCU). 4. Check all hoses for possible leaks. 5. Plug in washer or reconnect power 6. Verify pressure switch operation. 7. Verify CCU operation by running a Quick Diagnostic Test or any cycle
F02	OVERFLOW CONDITION
	Overflow level has been reached, and last for more than 2 seconds. In an overflow condition, the door remains locked and the drain pump runs constantly, and after 10 minutes, door will be unlocked in order to cut off the valves power. Then if overflow s till happens, start pump again. Turn off hot and cold water faucets and unplug the unit before servicing.
	<p>Possible Causes/Procedure</p> <ol style="list-style-type: none"> 1. Check the drain hose and make sure it is not plugged or kinked . 2. Unplug washer or disconnect power, if water still flows into the washer, replace the water valve. 3. Check wire harness connections to the drain pump, pressure switch, water inlet valve, and Central Control Unit (CCU). 4. Check/clean drain pump filter of foreign objects. 5. Check for drain pump failure. 6. Check the inlet valve for proper shut off. 7. Check the pressure switch for proper operation. 8. Remove hose from pressure switch. Dislodge any debris build up in the hose inside the outer tub. Debris in side the hose will not allow the switch to sense a pressure change.
F03	LONG DRAIN
	If the drain time exceeds 4 minutes the water valves turn off.Only in factory test. NOTES: Rotate knob to clear the display.
	<p>Possible Causes/Procedure</p> <ol style="list-style-type: none"> 1. Turn washer ON to verify pump operates. 2. Check the drain hose and make sure it is not plugged or kinked. 3. Unplug washer or disconnect power. 4. Check the electrical connections at the pump and make sure the pump is running. 5. Check the drain pump filter for foreign objects. 6. Plug in washer or reconnect power. 7. If the above does not correct the problem, go to step 8. 8. Unplug washer or disconnect power. 9. Replace the pump.

F05	WATER TEMPERATURE SENSOR ERROR
	If the water temperature sensor (NTC) value is out of range (Below 23 degrees F. or above 217 degrees) during wash cycle.
	Possible Causes/Procedure 1. Unplug washer or disconnect power. 2. Check the water temperature sensor and connection to it. 3. Refer to the Water Temperature Sensor section, page 8. 4. Check wire harness and connections between the Central Control Unit (CCU) and the water temperature sensor
F06	DRIVE MOTOR TACHOMETER ERROR
	If the control is unable to properly detect motor speed, the machine shuts down.
	Possible Causes/Procedure 1. Verify the shipping system including shipping bolts, spacers and cables are removed. 2. Run Quick Diagnostics Test to check motor drive system. 3. Unplug washer or disconnect power. 4. Check wire harness connections between the drive motor and the motor control board, and between the Central Control Unit (CCU). 5. Plug in washer or reconnect power.
F07	MOTOR OVERSPEED
	If there the motor speed is not controlled then it will switch OFF the motor and wait for the speed decreased to 0rpm. At the second occurrence in the same wash phase it will go to ERROR mode
	Possible Causes/Procedure 1. Run Quick Diagnostics Test to check motor drive system. 2. Unplug washer or disconnect power. 3. Check wire harness connections to the motor, and Central Control Unit (CCU). 4. Check the drive system for any worn or failed components. 5. Plug in washer or reconnect power. 6. Check the CCU by looking for operations of the drive motor . 7. Check the drive motor for powered rotations.
F13	DOOR LOCK ERROR
	Failed attempts to lock the door within 10 seconds. This error code is only shown in whirlpool factory test.
	Possible Causes/Procedure Door lock mechanism is broken or removed from door. Door switch/lock unit failure. 1. Run Quick Diagnostics Test to check motor drive system. 2. Unplug washer or disconnect power. 3. Check door switch/lock unit. 4. Check the wire harness connections to the door switch/lock unit and Central Control Unit (CCU).
F14	EEPROM ERROR
	A communication error between the Central Control Unit (CCU) and the EEPROM onboard the CCU occurred.
	Possible Causes/Procedure A power surge may cause this error. – Unplug washer or disconnect power for two minutes. – Verify CCU operation by running a Quick Diagnostic Test or any cycle.

F21	SERIAL COMMUNICATION ERROR
	The communication between the Central Control Unit (CCU) and the user interface board (UI) cannot be sent correctly.
	<p>Possible Causes/Procedure</p> <ol style="list-style-type: none"> 1. Run Quick Diagnostics Test to check the User Interface boards and motor. 2. Unplug washer or disconnect power. 3. Check wire harness connections to the user interface and Central Control Unit (CCU). <ul style="list-style-type: none"> – Check connections of the CCU board within the housing. – Make sure all grounding switches are engaged. 4. Check that the serial harness at the UI. 5. Plug in washer or reconnect power.
F22	LOADS DET ECTED DURING CLEAN WASHER CYCLE
	The load is detected in the drum during the start of clean washer cycle.
	<p>Possible Causes/Procedure</p> <ol style="list-style-type: none"> 1. Make sure that there is no load in the drum. If the drum is empty. 2. Rotate drum by hand to check for any binding of the spin basket. Possibility of clothing stuck between spin basket and outer tub or the rear seal may not be seated flush against rear bearings. 3. Check the drum's fixation.
F23	PRESSURE SWTICH ERROR
	The wash level and level heater safety are switched on at the same time
	<p>Possible Causes/Procedure</p> <ol style="list-style-type: none"> 1. Unplug washer or disconnect power. 2. Check wire harness connections to pressure switch and Central Control Unit (CCU). 3. Check connections of the CCU board within the housing. 4. Check the pressure switch for worn or failed conditions .
F24	VALVES LEAKAGE/OVERFLOW FAILURE
	Overflow level has been reached for more than 5 times, but each period is shorter than 2 seconds.
	<p>Possible Causes/Procedure</p> <ol style="list-style-type: none"> 1. Check the drain hose and make sure it is not plugged or kinked. 2. Remove hose from pressure switch. Dislodge any debris build up in the hose inside the outer tub. 3. Unplug washer or disconnect power. 4. Check wire harness connections to the drain pump, pressure switch, water inlet value, and Central Control Unit (CCU). 5. Check/clean drain pump filter of foreign objects. 6. Check for drain pump failure. 7. Check the inlet valve for proper shut off. 8. Check the pressure switch for proper operation.

F26	PUMP DRIVE SYSTEM ERROR
	When the connection between pump and the Central Control Unit (CCU) is lost during cycle drain
	Possible Causes/Procedure 1. Verify CCU operation by running a Quick Diagnostic Test or any cycle. 2. Unplug washer or disconnect power. 3. Check wire harness connections to the pump and Central Control Unit (CCU). 4. Plug in washer or reconnect power.
F27	MOTOR CONTROL UNIT ERROR
	Motor reversing error
	Possible Causes/Procedure 1. Verify the shipping system including shipping bolts, spacers and cables are removed. 2. Perform Quick Diagnostic Test 3. Unplug washer or disconnect power. 4. Check wire harness connections between the drive motor, motor control board, and between the Central Control Unit (CCU).
F28	MOTOR CONTROL UNIT ERROR
	Motor High speed switch error
	Possible Causes/Procedure 1. Verify the shipping system including shipping bolts, spacers and cables are removed. 2. Perform motor Quick Diagnostic Test 3. Unplug washer or disconnect power. 4. Check wire harness connections between the drive motor, motor control board, and between the Central Control Unit (CCU).
F29	DOOR SWITCH ERROR
	Door is not detected to be open and close for 3 continuous cycles.
	Possible Causes/Procedure 1. Power on the machine, and rotate knob to any cycle position, open the door and then close. Then press start button to continue to see if the error cleared. If the failure display condition still exists, go to step 2. 2. Run Quick Diagnostics Test to check door lock system. 3. Unplug washer or disconnect power. 4. Check the electrical connections at the side of door switch and the side of CCU, to make sure the connection is correct 5. Verify if the switch contacts are stuck closed. If closed and the door is open, replace the door switch mechanism. 6. Plug in washer or reconnect power. 7. If the above does not correct the problem, go to step 6 8. Unplug washer or disconnect power 9. Replace door switch 10. Replace CCU
F30	DOOR LOCK BROKEN OR DOOR SWITCH ERROR
	If it has been detected that door switch is open while the door is locked for more than 2 seconds.
	Door switch open while door is locked. 1. Push the door and check if it is completely closed. 2. Verify CCU operation by running a Quick Diagnostic Test or any cycle. 3. Verify if the switch contacts are stuck open. If open and the door are closed, replace the door switch mechanism

Fod

**SUDS LOCK (OVERDOSE OF DETERGENT
DETECTED DURING THE WASH CYCLE)**

If suds are detected continuously by the pressure switch during drain or spin, washer will enter Suds Detection mode. The washer will fill with 3/4 gallon (2.67 Liters) of water, then rest for 10 minutes with no tumbling. Washer will then drain. If error occurs during spin cycle, the unit will then start spinning.

Possible Causes/Procedure

If too much detergent was used:

- Run the unit through a RINSE/SPIN cycle.
- Run a NORMAL cycle without adding any detergent.

This should clear the unit of the excess detergent.

1. Check the drain hose and make sure it is not plugged or kinked .
2. Is the drain standpipe higher than 9 feet, This can cause pump cavitations resulting in same failure code.
3. Unplug washer or disconnect power.
4. Check wire harness connections to the drain pump, pressure switch, and Central Control Unit (CCU).
5. Check/clean drain pump filter of foreign objects.
6. Plug in washer or reconnect power .
7. Check drain pump.
8. Check the pressure switch and pressure switch hose.
9. Verify CCU operation by running a Quick Diagnostic Test or any cycle.

DIAGNOSTIC TEST

The two test modes contain three modes of operation.

Test modes:

- Universal test mode, with additional user interface test at the beginning.
- Quick test mode

Operation modes:

- User interface test
- Automated test
- Loads tests to assist in diagnosing potentially non-electrical issue.

Starting Universal Test Mode

1. Close the door
2. Rotate the knob and select the CLEAN WASHER cycle.

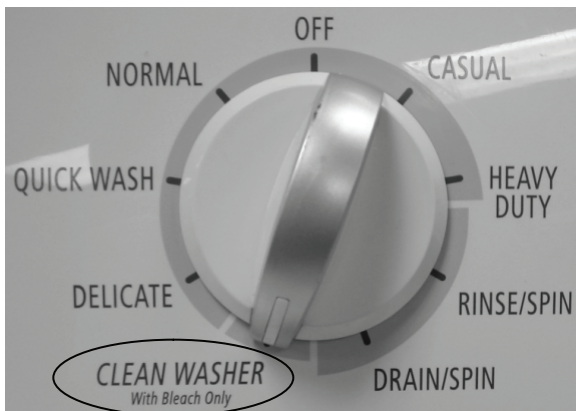

3. Press "CANCEL/DRAIN" button for 2 times, and then press "START" button for 2 times within 5 seconds.



4. Upon release, and after door locked, all console LED lights will turn ON except option LED.



5. Press the option buttons, one at a time, to check the User Interface.



6. Following steps are automatically driven, or they can be manually advanced by pressing the Cancel/Drain button 2 time. See table on page 6-9.



! WARNING



Electrical Shock Hazard

Disconnect power before servicing.
 Replace all parts and panels before operating.
 Failure to do so can result in death or electrical shock.

UNIVERSAL DIAGNOSTICS TEST

NOTES:

- To cancel out of this mode rotate the selector knob. (This exits you out of the program.)
- Press “CANCEL/DRAIN” button 2 times can advance to the next step of the procedure.
- If the starting procedure fails, switch the knob and back to the CLEAN WASH cycle, the repeat the starting procedure.

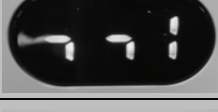
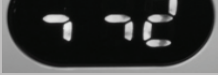
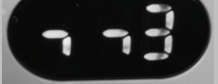
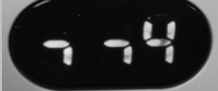
Indication Factory Test Display (7-SEGMENT LED)	Control Action	Actuators to be Checked	Failure code for failure mode
OFF 	Door locks	Door lock system	F13
0 (Phase LED rolling) 	Checks the EEPROM data's validity Pump turns ON if the water level is detected to be above the wash level	Drain system EEPROM test	F03, F05, F14, F21, F23, F24, F26, F30
8 	All display led are turned on UI option led will be turned on after options are pushed.	User interface	F21, F25
1 	Turns hot valve inlet on (About 15s) Turns bleach valve inlet on (About 15s) Turns cold valve inlet on (About 15s) Fill by cold water inlet valve to Level_wash	Hot Water inlet valve Cold Water inlet valve Bleach inlet valve	F01, F21, F23, F24
2 	Motor reverse. Runs at normal washing speed. (About 15s)	Reversing relay Safety relay Motor thermistor Tachometer signal	F06, F07, F21, F27
3 	Pump turns ON to drain the washer	Drain system	F03, F21
4 	Drive motor to max speed	Motor speed Tap field relay	F06, F07, F21, F27, F28

Starting Quick Test Mode

All of the steps below must be done in sequence in order to reach the Diagnostic Test. This executes the automatic test but does not run the user interface test.

1. Close the door.
2. Switch the knob and select the CLEAN WASHER cycle.

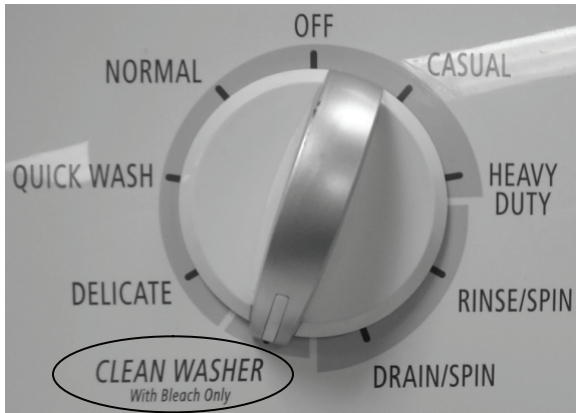

3. Press "START" button for 4 times within 5 seconds.



4. Following steps are automatically driven, or they can be manually advanced by pressing the Cancel/Drain button 2 times. See table page 6-11.

NOTES:

Please ensure that current machine status is in PROGRAM (SELECTION) mode. Otherwise, please follow the instructions below to bring it back to PROGRAM (SELECTION) mode.

- 1) PAUSE mode: Press and hold CANCEL/DRAIN button for 3 seconds for reset, then switch knob to enter PROGRAM mode.
- 2) FAILURE mode: Switch knob to enter PROGRAM mode.
- 3) EXECUTION mode: Press and hold CANCEL/DRAIN button for 3 seconds for reset, then switch knob to enter PROGRAM mode.
- 4) STANDBY mode: Press START button or switch knob to enter PROGRAM mode
- 5) DELAY START mode: Switch knob to enter PROGRAM mode.



⚠ WARNING





Electrical Shock Hazard

Disconnect power before servicing.
 Replace all parts and panels before operating.
 Failure to do so can result in death or electrical shock.

QUICK DIAGNOSTICS TEST

NOTES:

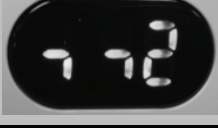
- To cancel out of this mode rotate the selector knob. (This exits you out of the program.)
- Press “CANCEL/DRAIN” button 2 times can advance to the next step of the procedure.
- If the starting procedure fails, switch the knob and back to the CLEAN WASH cycle, the repeat the starting procedure.

Indication	Control Action	Actuators to be Checked	Failure code for failure mode
OFF Estimated Time Remaining 	Door locks	Door lock system	F13
1 (Phase LED rolling) Estimated Time Remaining 	Checks the EEPROM data's validity Pump turns ON if the water level is detected to be above the wash level	Drain system EEPROM test	F03, F05, F14, F21, F23, F24, F26, F30
1 Estimated Time Remaining 	Turns hot valve inlet on (About 15s) Turns bleach valve inlet on (About 15s) Turns cold valve inlet on (About 15s) Fill by cold water inlet valve to Level_wash	Hot Water inlet valve Cold Water inlet valve Bleach inlet valve	F01, F21, F23, F24
2 Estimated Time Remaining 	Motor reverse. Runs at normal washing speed. (About 15s)	Reversing relay Safety relay Motor thermistor Tachometer signal	F06, F07, F21, F27
3 Estimated Time Remaining 	Pump turns ON to drain the washer	Drain system	F03, F21
4 Estimated Time Remaining 	Drive motor to max speed	Motor speed Tap field relay	F06, F07, F21, F27, F28

ELECTRONIC ASSEMBLIES - REMOVAL OR REPLACEMENT



! WARNING

Electrical Shock Hazard

Disconnect power before servicing.

Replace all parts and panels before operating.

Failure to do so can result in death or electrical shock.

IMPORTANT: Electrostatic (static electricity) discharge may cause damage to electronic control assemblies.

NOTE: Be sure to perform the Diagnostic Tests before replacing the control board.

To remove Central Control Unit (CCU):

1. Unplug washer or disconnect power, switch the knob to the OFF position.
2. Remove front panel and dispenser drawer.
3. Remove screws that were covered by dispenser drawer.
4. Remove control panel and all connectors from the CCU.
5. Lift tab at left corner of CCU with a flat blade screwdriver. Slide the CCU to the rear of the washer cabinet until the two tabs on the back of the CCU align with the keyhole notches in the control panel. Pull the CCU away from control panel.

To reassemble CCU:

1. Align the tab on top of the CCU with the notch in the cabinet. Also, align the posts on the back of the CCU with the hole in the back of the cabinet.
2. Align the two tabs on the back of the CCU with the keyhole notches in the control panel.
3. Reconnect wire harness.
4. Verify that the CCU encoder and the knob are both at the "off" position before assembling.
5. Plug in washer or reconnect power.

To remove LED assembly:

1. Unplug washer or disconnect power.
2. Remove front panel and dispenser drawer.
3. Remove the (insert the quantity) screws that were covered by the dispenser drawer.
4. Remove control panel.
5. Disconnect LED assembly wire harness from the CCU.
6. Along the upper side of the LED assembly there are two tabs, insert a flat blade screwdriver to release the upper side of the LED assembly.
7. On the left hand side, press tab to release left side of the LED assembly.
8. Gently pry up and completely release the entire LED assembly.

To remove Motor Control Unit (MCU):

1. Unplug washer or disconnect power.
2. Disconnect the wire harness from the MCU.
3. Remove drain hose from the MCU.
4. Remove the screw using a flat blade screwdriver. Lift up the front tab and slide the assembly to the rear. Separate the MCU from the cover.

TROUBLESHOOTING GUIDE



⚠ WARNING

Electrical Shock Hazard

**Disconnect power before servicing.
Replace all parts and panels before operating.
Failure to do so can result in death or electrical shock.**

PROBLEM	POSSIBLE CAUSE/TEST
WON'T POWER UP (buttons do not respond when pressed)	<p>NOTE: Possible Cause/Tests must be performed in the sequence shown for each problem.</p> <ol style="list-style-type: none"> 1. Check that the unit is plugged into a working outlet and for blown fuses. 2. Check for power going to Central Control Unit (CCU) by listening for a click in the CCU when unit is plugged in. If no click, replace CCU. 3. Unplug washer or disconnect power. 4. Check continuity of line cord and line filter. 5. Check harness connections to CCU. 6. Plug in washer or reconnect power. 7. Check the button/LED assembly by selecting different cycles and changing the modifiers and options available to confirm the button/LED assembly is responding. 8. Check the connection of the power cord to the line filter and at the CCU. Check to confirm the door closes fully.
WON'T START CYCLE	<ol style="list-style-type: none"> 1. Open and close the door. The door has to be opened between consecutive wash cycles. 2. Check the door switch/lock unit using the diagnostics. See Quick Diagnostic Test. 3. If door is locked, drain the unit. 4. Unplug washer or disconnect power. 5. Check the wire harness connections. 6. Plug in washer or reconnect power. 7. Check the button/LED assembly by selecting different cycles and changing the modifiers and options available to confirm the button/LED assembly is responding.
WON'T SHUT OFF	<ol style="list-style-type: none"> 1. Check for a Fault/Error Code on the display. 2. Switch knob to OFF position. 3. Check the button/LED assembly by selecting different cycles and changing the modifiers and options available to confirm the button/LED assembly is responding. 4. Unplug washer or disconnect power. 5. Check that the drain hose and drain pump filter are clear of foreign objects and not plugged. 6. Plug in washer or reconnect power. 7. Check drain pump. 8. Verify CCU operation by running a Quick Diagnostic Test or any cycle. 9. Check Knob assembly on the CCU to ensure the direction is properly oriented. See page 9.
CONTROL WON'T ACCEPT SELECTIONS	<ol style="list-style-type: none"> 1. Switch knob to OFF position. 2. Drain the unit, and then check that the drain hose and drain pump filter are clear of foreign objects. 3. Check the button/LED assembly by using the Universal test mode. 4. Unplug washer or disconnect power. 5. Check harness connections. 6. Plug in washer or reconnect power. 7. Verify CCU operation by running a Diagnostic Test or any cycle.
WON'T DISPENSE	<ol style="list-style-type: none"> 1. Verify the unit is level. 2. Verify dispenser drawer is not clogged with detergent. 3. Check water connections to the unit and within the unit. Check for plugged screen in water source. 4. Check the water supply and the water valve. 5. Unplug washer or disconnect power. 6. Check harness connections. 7. Plug in washer or reconnect power. 8. Verify CCU operation by running a Quick Diagnostic Test or any cycle.
WON'T FILL	<ol style="list-style-type: none"> 1. Check installation. Verify hot and cold water faucets are open. 2. Check inlet valves. 3. Unplug washer or disconnect power. 4. Check water connections to the unit and within the unit. Make sure water supply hoses are unobstructed. Check for plugged screen. 5. Plug in washer or reconnect power. 6. Check operating pressure switch. 7. Check drain pump motor. 8. Verify CCU operation by running a Quick Diagnostic Test or any cycle. 9. Check the steps listed under WON'T DISPENSE.
OVER FILLS	<ol style="list-style-type: none"> 1. Verify the unit is level. 2. Check pump drain system – this could indicate a failure to drain. 3. Unplug washer or disconnect power. 4. Check operating pressure switch. 5. Check pressure switch hose. 6. Plug in washer or reconnect power. 7. Verify flow meter operation by blowing air through the part and measuring the resistance. 8. Verify CCU operation by running a Quick Diagnostic Test or any cycle.
DRUM WON'T ROTATE	<ol style="list-style-type: none"> 1. Check drive belt. 2. Check drive motor. 3. Unplug washer or disconnect power. 4. Check wire harness connections. 5. Plug in washer or reconnect power. 6. Perform the Motor Continuity Test.

MOTOR OVERHEATS	<ol style="list-style-type: none"> 1. Check drive motor. 2. Unplug washer or disconnect power. 3. Check wire harness connections. 4. Check drive belt. 5. Plug in washer or reconnect power. 6. Check for obstruction between the spin basket and the outer tub.
WON'T DRAIN	<ol style="list-style-type: none"> 1. Unplug washer or disconnect power. 2. Check wire harness connections. 3. Check drain pump. 4. Check drain pump motor. 5. Check that the drain hose and drain pump filter are clear of foreign objects. 6. Plug in washer or reconnect power. 7. Verify CCU operation by running a Quick Diagnostic Test or any cycle.
MACHINE VIBRATES	<ol style="list-style-type: none"> 1. Remove shipping system. 2. Check installation. 3. Check leveling feet.
INCORRECT WATER TEMPERATURE	<ol style="list-style-type: none"> 1. Check that the inlet hoses are connected properly. 2. Unplug washer or disconnect power. 3. Check water temperature sensor for an abnormal condition. See the Water Temperature Sensor section, page 10. 4. Plug in washer or reconnect power. 5. Verify CCU operation by running a Diagnostic Test or any cycle.
DISPLAY FLASHING	See Failure/Error Display Codes.

WIRING DIAGRAMS WASHER

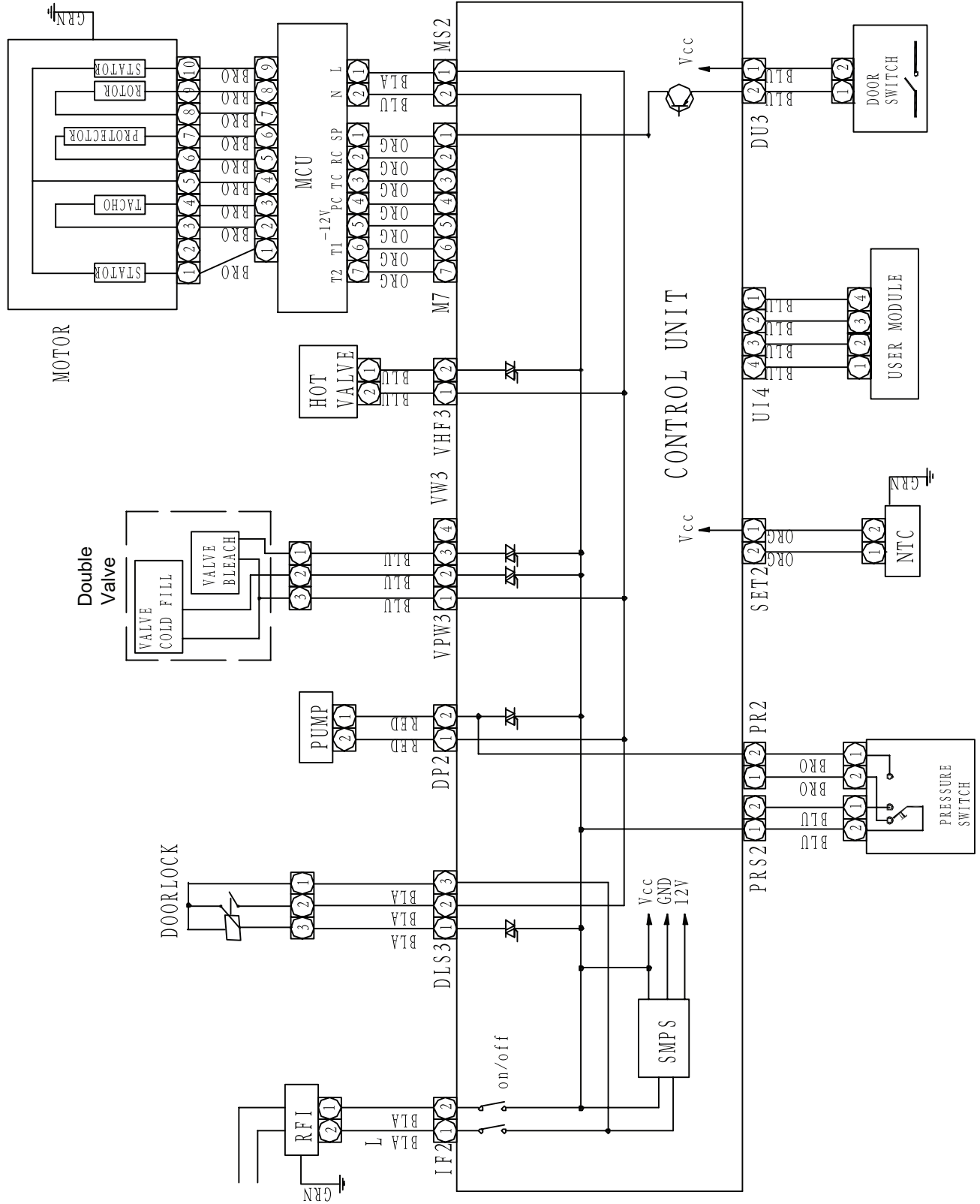

— NOTES —

PRODUCT SPECIFICATIONS AND WARRANTY INFORMATION SOURCES

IN THE UNITED STATES:

FOR PRODUCT SPECIFICATIONS AND WARRANTY INFORMATION CALL:

FOR WHIRLPOOL PRODUCTS: 1-800-253-1301

FOR KITCHENAID PRODUCTS: 1-800-422-1230

FOR ROPER PRODUCTS: 1-800-447-6737

FOR TECHNICAL ASSISTANCE WHILE AT THE CUSTOMER'S HOME CALL:

THE TECHNICAL ASSISTANCE LINE: 1-800-832-7174

**HAVE YOUR STORE NUMBER READY TO IDENTIFY YOU AS AN
AUTHORIZED IN-HOME SERVICE PROFESSIONAL**

FOR LITERATURE ORDERS:

PHONE: 1-800-851-4605

FOR TECHNICAL INFORMATION AND SERVICE POINTERS:

www.servicematters.com

IN CANADA:

FOR PRODUCT SPECIFICATIONS AND WARRANTY INFORMATION CALL:

1-800-461-5681

FOR TECHNICAL ASSISTANCE WHILE AT THE CUSTOMER'S HOME CALL:

THE TECHNICAL ASSISTANCE LINE: 1-800-488-4791

**HAVE YOUR STORE NUMBER READY TO IDENTIFY YOU AS AN
AUTHORIZED IN-HOME SERVICE PROFESSIONAL**

