

MAYTAG Training SERVICES

Samsung AD Refrigerator Familiarization

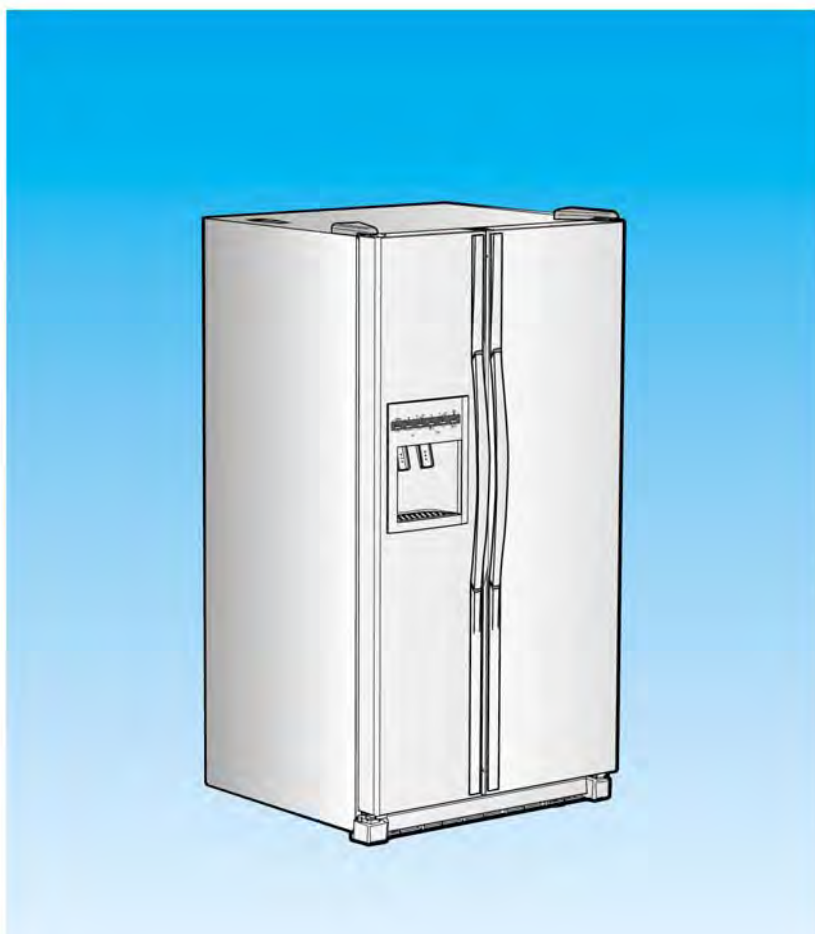

MAYTAG

Model Number Nomenclature	1
Specifications	3
Refrigeration System	4
Freezer and Refrigerator Air Circulation	5
Display Designs	6
Self Diagnosis At Initial Start Up	7
Test (Forced Operation/Forced Defrost).....	8
Defrost Cycle	9
Showroom Mode.....	9
Ice Type	10
Freezer Temperature Setting.....	10
Refrigerator Temperature Setting	10
Child Lock	10
Night Light.....	10
Power Freeze.....	10
Filter Reset.....	10
Self Diagnostics	11
Load Status.....	12
Option Setting	13
Damper Access	18
Ice Maker Removal.....	18
Ice Maker Operation	18
Evaporator Section.....	18
High Voltage Checks	19

Model Number Nomenclature

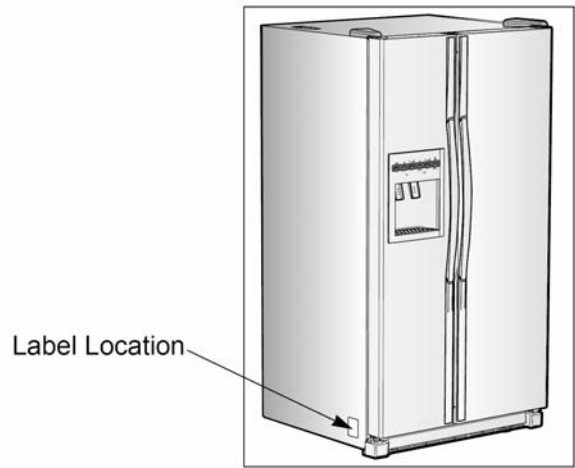
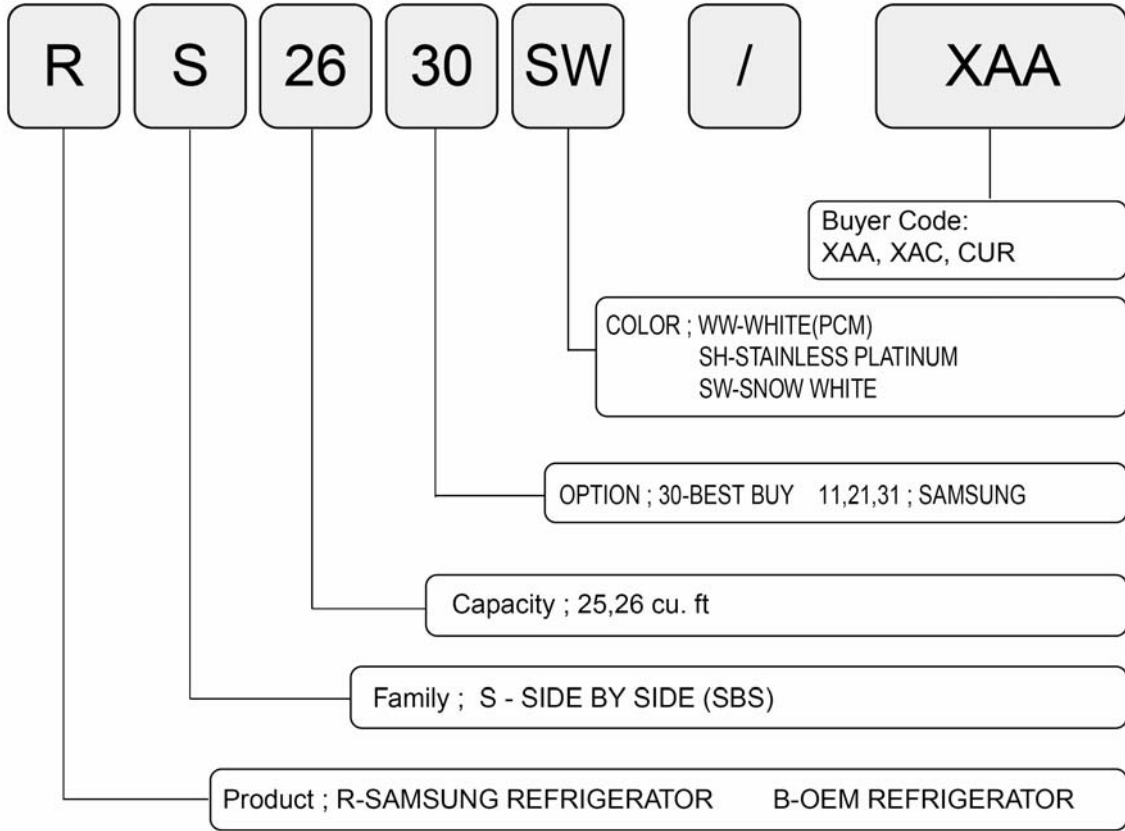

Specifications

ELECTRICAL SPECIFICATIONS

Defrost Control From 6 to 11 hrs
 Defrost Thermistor(502AT)..... 59°F(off)
 Electrical Rating AC115V 60Hz 11.6 Amps
 Maximum Current Leakage 0.25 mA
 Maximum Ground Path Resistance 0.1Ohm
 Energy Consumption kWh/mo.
 Bimetal..... 104°F (on)/140°F (off)

NO LOAD PERFORMANCE

Ambient Temperature	<u>70°F</u>	<u>90°F</u>
Refrigerator, °F	34~46	34~46
Freezer, °F	-11~7	-11~7
Run Time, %	< 40	< 60

REFRIGERATION SYSTEM

Refrigerant Charge (R134a)..... 6.17 oz
 Compressor(MK183C-L2U)..... 1032 Btu/hr
 Compressor oil..... Freol α -15
 Capillary tube(Dia, Length) 0.033 " ,130 "
 Dryer Molecular Sieve XH-9

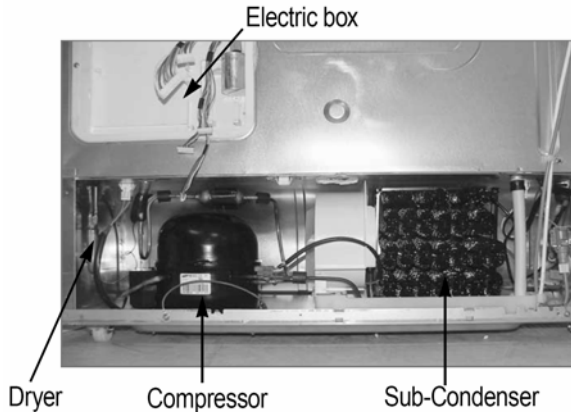

INSTALLATION

Clearance must be provided for air circulation

AT TOP	1 "
AT SIDES	1/8 "
AT REAR	1 "

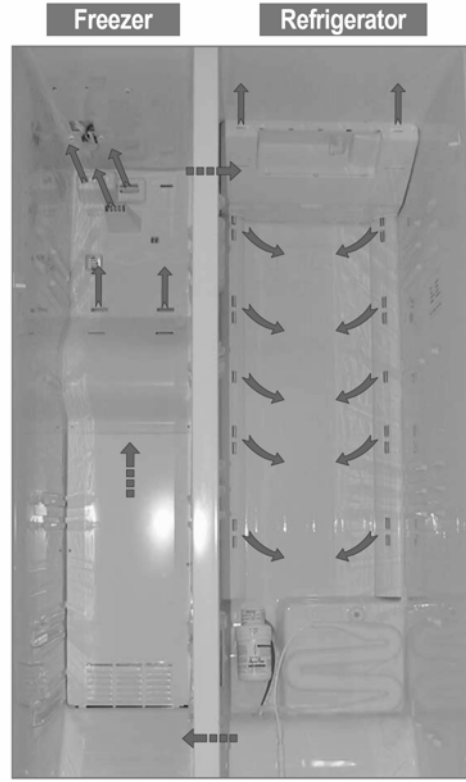

MODELS

RS2530, RS2630

REPLACEMENT PARTS

- | | |
|--------------------------|-------------|
| PBA MAIN(RS2*11) | DA41-00216A |
| PBA MAIN(RS2*21) | DA41-00217B |
| PBA MAIN(RS2*30) | DA41-00218C |
| PBA MAIN(RS2*31) | DA41-00219D |
| PBA PANEL(RS2*11) | DA41-00218A |
| PBA PANEL(RS2*21) | DA41-00218B |
| PBA PANEL(RS2*30) | DA41-00235A |
| PBA PANEL(RS2*31) | DA41-00235B |
| TRANS DC(115V/60Hz) | DA26-00022B |
| TRANS DC(220V/50,60Hz) | DA26-00022C |
| TRANS DC(127V/60Hz) | DA26-00022D |
| SENSOR(DEF SENSOR) | DA32-00006D |
| SENSOR(F SENSOR) | DA32-00006D |
| SENSOR(R SENSOR) | DA32-00006B |
| SENSOR(ICE MAKER SENSOR) | DA32-10108B |
| RELAY | DA35-10013Q |
| OVERLOADED REALY | DA35-10013D |
| RUN CAPACITOR(12 βfi) | 2501-001045 |
| FAN MOTOR(FREEZER) | DA31-00003W |
| FAN MOTOR(UNIT) | DA31-00103A |

Refrigeration System

Compressor → Condenser → Hot Pipe → Dryer → Capillary Tube → Evaporator → Suction Pipe → Compressor

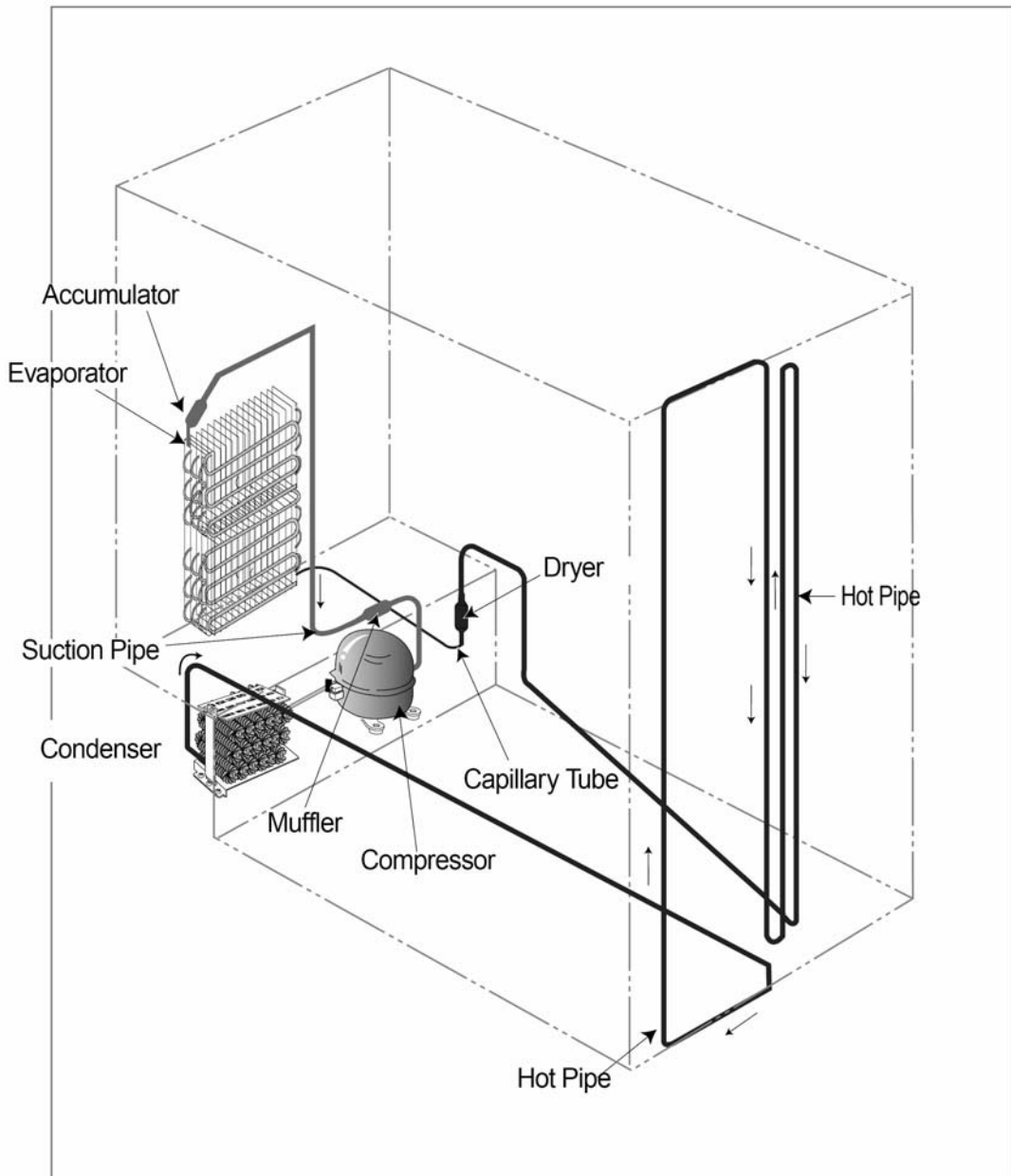

Freezer and Refrigerator Air Circulation

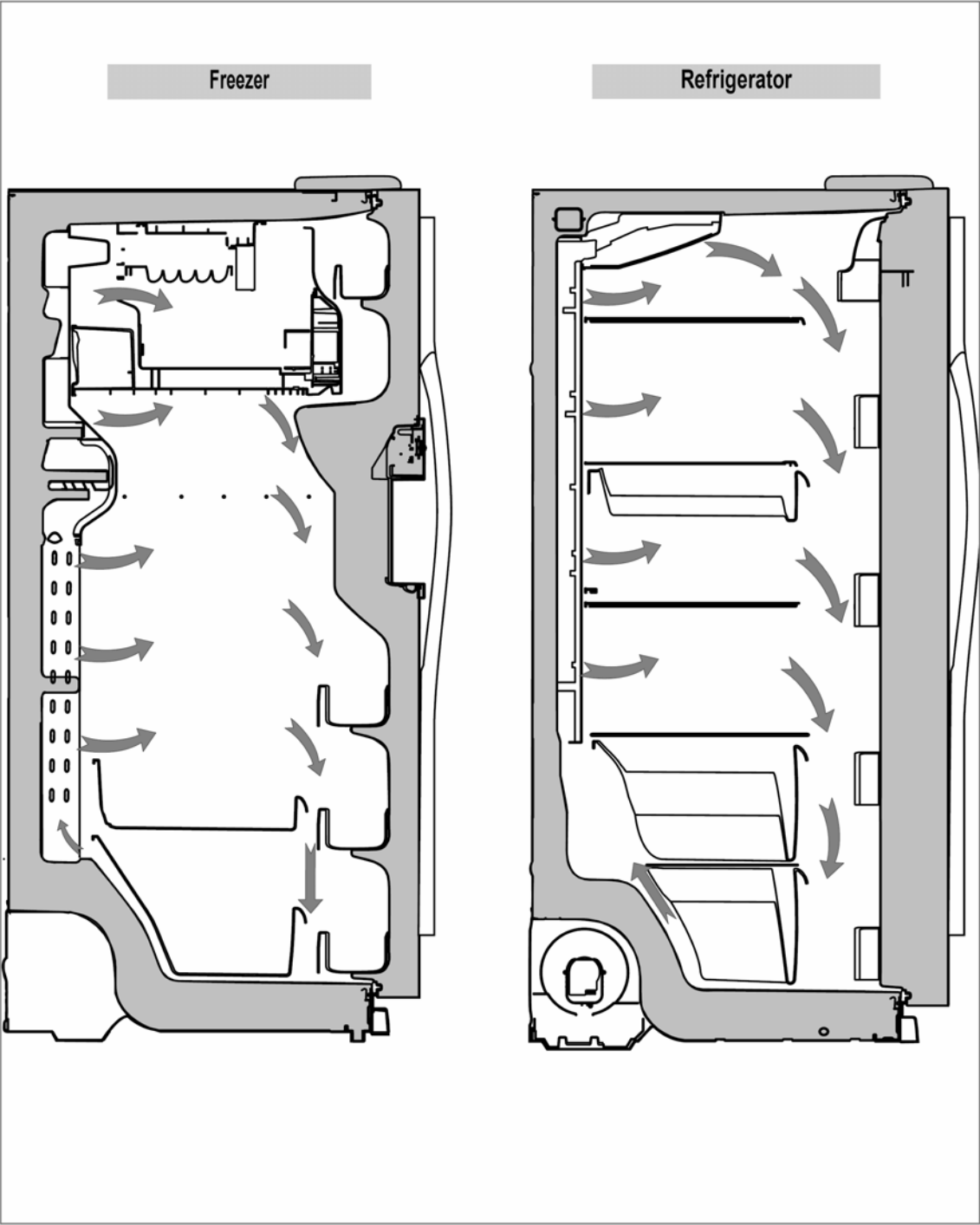

Display Designs

RS2630SW/XAA (for Best Buy)

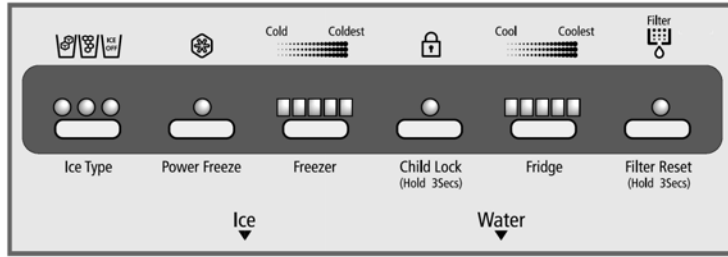

RS2531**/RS2631**

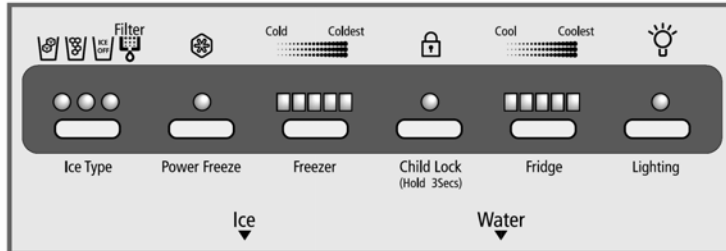

RS2521**/RS2621**

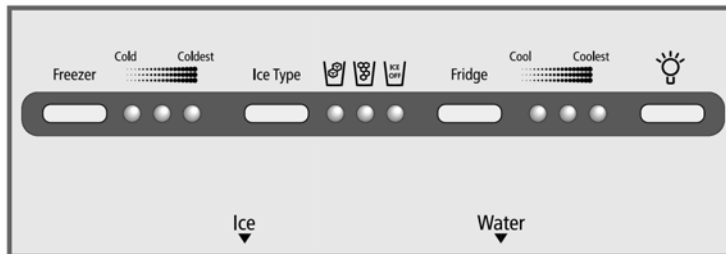

RS2511**/RS2611**

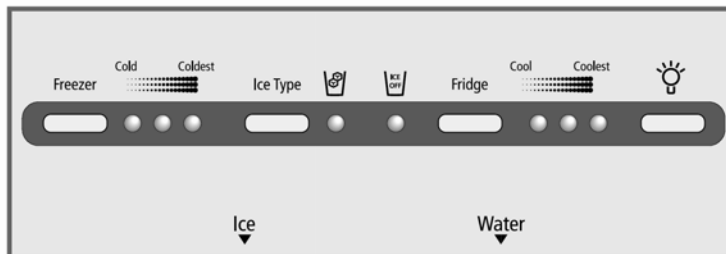

Self Diagnosis At Initial Start Up

When the refrigerator is first plugged in it will enter a self diagnostics test. If any of the thermistors fail to pass the diagnostic tests, the display will illuminate to indicate the failed thermistor. Refer to the service data below to determine which thermistor has failed.

NO	Item	DISPLAY LED	Trouble Shooting	Remark
01	Refrigerator SENSOR	Refrigerator "MID"	Fall out SENSOR HOUSING in Refrigerator contact failure, breakage of wire, short-circuit, inferior Refrigerator SENSOR and others.	Indicating a defect when the temp sensing of Refrigerator SENOSR is above (149 °F/65 °C) and below (-58°F/-50 °C).
02	Peripheral temp SENSOR	Refrigerator "MIN"	Fall out peripheral temp SENSOR HOUSING , contact failure, breakage of wire, short-circuit, inferior peripheral sensor and others.	Indicating a defect when the temp sensing of peripheral temp SENOSR is above (149 °F/65 °C) and below (-58°F/-50 °C).
03	Freezer SENSOR	Freezer "MAX"	Fall out SENSOR HOUSING in Freezer, contact failure, breakage of wire, short-circuit, inferior Freezer SENSOR and others.	Indicating a defect when the temp sensing of Freezer SENOSR is above (149 °F/65 °C) and below (-58°F/-50 °C).
04	Freezer Defrost SENSOR	Freezer "MID"	Fall out Deforst -SENSOR HOUSING in the evaporator of Freezer, contact failure, breakage of wire, short-circuit, inferior sensor and others.	indicating a defect when the temp sensing of Freezer Defrost SENOSR is above (149 °F/65 °C) and below (-58°F/-50 °C).
05	Freezer Defrost ERROR	Freezer "MIN"	Fall out Freezer Heater Housing, contact failure, breakage of wire, short circuit, inferior Freezer Heater, or inferior Defrost temp fuse and etc.	On Freezer Defrost 90 min. automatic completion
06	I/M Function ERROR	ICE OFF	Ejection restoration failure more than 3 times.	
07	I/M SENSOR ERROR	Cubed LED	Fall out I/M SENSOR HOUSING, contact failure, breakage of wire, short-circuit, inferior I/M-SENSOR and etc.	

Test (Forced Operation/Forced Defrost)

To enter the forced operation and forced defrost mode press and Hold the Refrigerator Temperature Set button and the Ice type button for 8 seconds, the panel display will shut off.

RS2630SW/XAA (for Best Buy)

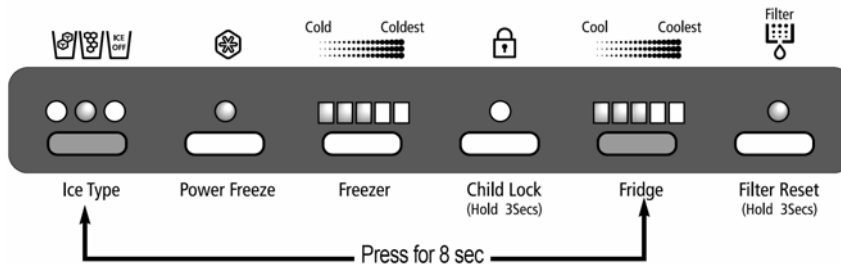

RS2531**/RS2631**

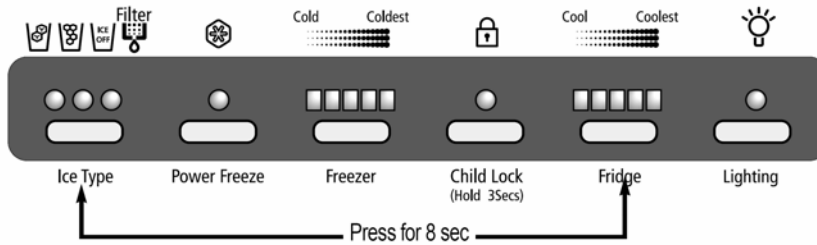

RS2521**/RS2621**

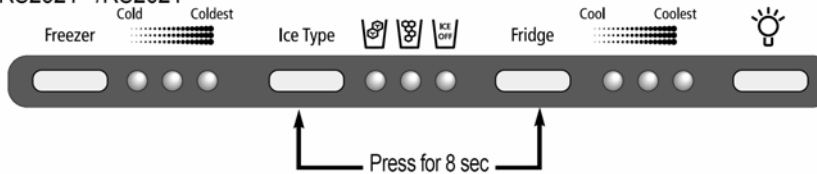

RS2511**/RS2611**

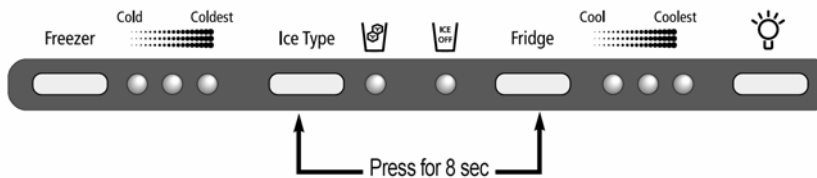

Pressing any button immediately after the display goes blank will cycle the Test Mode, a beep sound confirms you have entered the test mode and the forced operation has been entered. The fresh food Temperature will default to 35.6F and the Freezer Temp will default to -13F. Forced Operation is cancelled automatically after 24 hours. Pressing any other button forces the unit in the forced freezer defrost mode. Pressing any other button will cancel the test and will time out off the test mode within 12 seconds. After Forced operation the unit automatically initiates a defrost operation. Unplugging the refrigerator and plugging it back in is the easiest way to cancel the Test Mode.

Defrost Cycle

The defrost cycle removes ice around the evaporator, This is terminated by a temperature sensor near the evaporator. When the temperature reaches 59 degrees F the defrost cycle is turned off. The defrost system will adjust compressor run time between defrost cycles in a range between four and eleven hours. The initial defrost cycle will happen within 4 hours of the refrigerator being plugged. After the initial defrost cycle the microprocessor determines the need for defrost by measuring a number of factors including:
The number and length of door openings and the ambient temperature.

Showroom Mode

To activate the show room mode, Press and Hold the Freezer Temperature Set button and Ice type button for 8 seconds, a chime confirms you are in the showroom mode.

RS2630SW/XAA (for Best Buy)

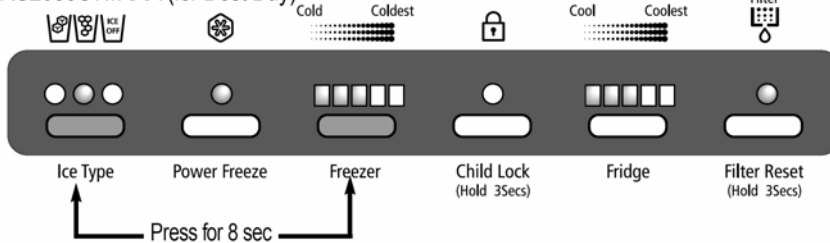

RS2531**/RS2631**

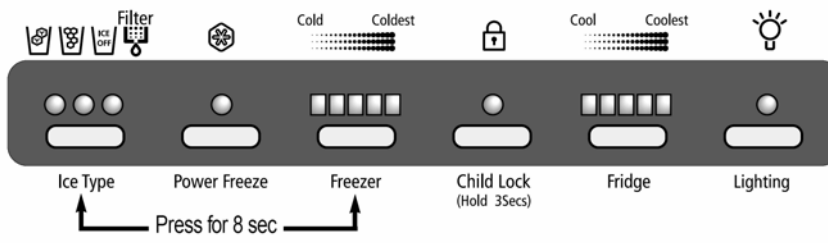

RS2521**/RS2621**

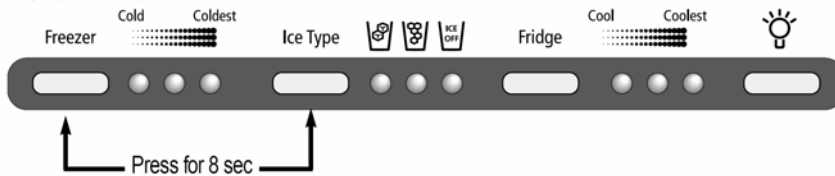

RS2511**/RS2611**

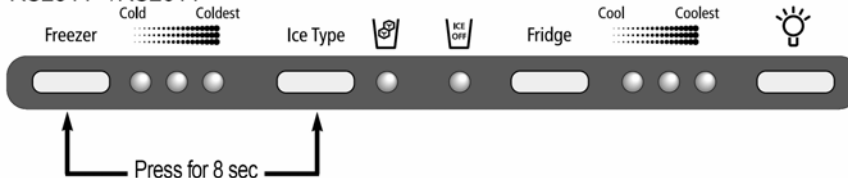

All functions will work except the compressor and the defrost circuit. To exit the show room mode press and hold the same two keys for 8 seconds or unplug and plug the refrigerator back in.

Ice Type

Press the ice button to cycle between cubed ice, crushed ice, or no ice.

!!Important Servicer Note!!

With the No Ice selection chosen, the icemaker will stop **ALL** ice production.

Freezer Temperature Setting

The Initial Freezer temperature Setting is -4F, pressing the freezer temperature button will light additional bars and decrease the temperature. When all LED's are lit the minimum temperature is reached. Pressing the freezer temperature button one more time will cycle the temperature setting to maximum, leaving only one bar illuminated and a setting of 6.8 F.

Refrigerator Temperature Setting

The Initial fresh food temperature Setting is 37.4 F, pressing the refrigerator temperature button will light additional bars and decrease the temperature. When all LED's are lit the minimum temperature is reached. Pressing the freezer temperature button one more time will set the fresh food temperature to maximum, indicated by only one bar illuminated and a setting of 46.0 F.

Child Lock

To activate Child Lock press and hold the child lock button for 3 seconds. Child Lock disables all front panel functions including Water and Ice dispensing. Pressing Child Lock again for three seconds disengages this feature.

Night Light

Press the light button to turn the night light on press again to turn it off.

Power Freeze

Pressing the Power Freeze button starts the power freeze option. The Compressor and the Freezer fan operate continuously for 2 hours and 30 minutes. However; a power freeze will not initiate during defrost. Selecting Power Freeze will delay a future defrost until the power freeze cycle has completed.

Filter Reset

Pressing the Filter Reset key for 3 seconds resets the water filter counter. On refrigerators without a water filter reset key press ice type and power freezer for three seconds. This will reset the filter light back to green which is indicated with a chime.

The filter LED changes to Orange at 450 gallons to let the customer know they need to order a new filter. When the filter reaches 500 gallons, the filter LED changes to Red.

Self Diagnostics

To enter the self diagnostics mode Press and Hold the night light/filter reset button and the Ice type button for 8 seconds.

RS2630SW/XAA (for Best Buy)

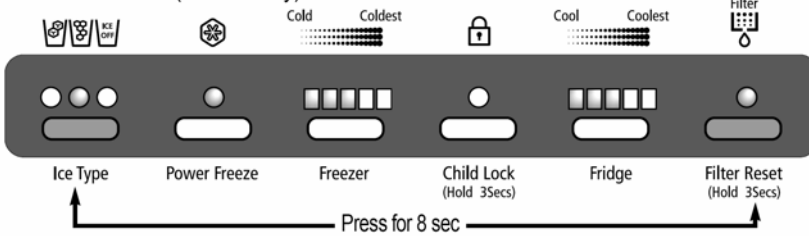

RS2531**/RS2631**

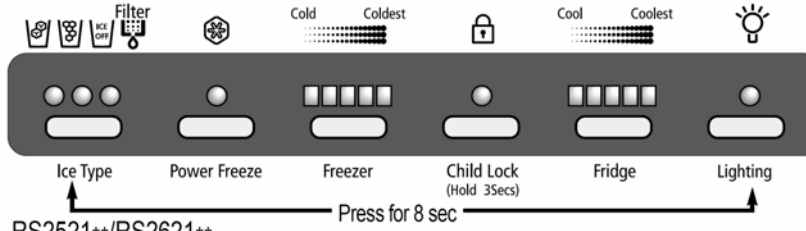

RS2521**/RS2621**

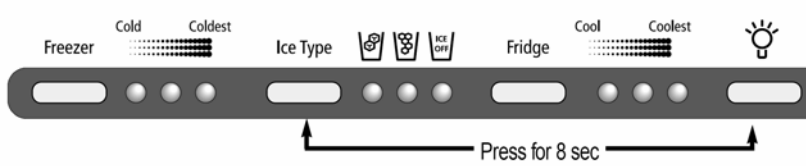

RS2511**/RS2611**

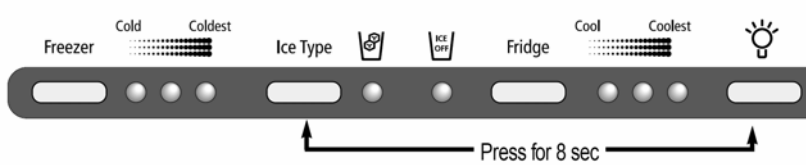

To exit the self diagnostics mode press and hold night light button and the ice type button for eight seconds or unplug and then plug refrigerator back in.

Load Status

To enter load status Press and Hold the Filter reset button and Ice type button for 6 seconds, then press the refrigerator temperature button.

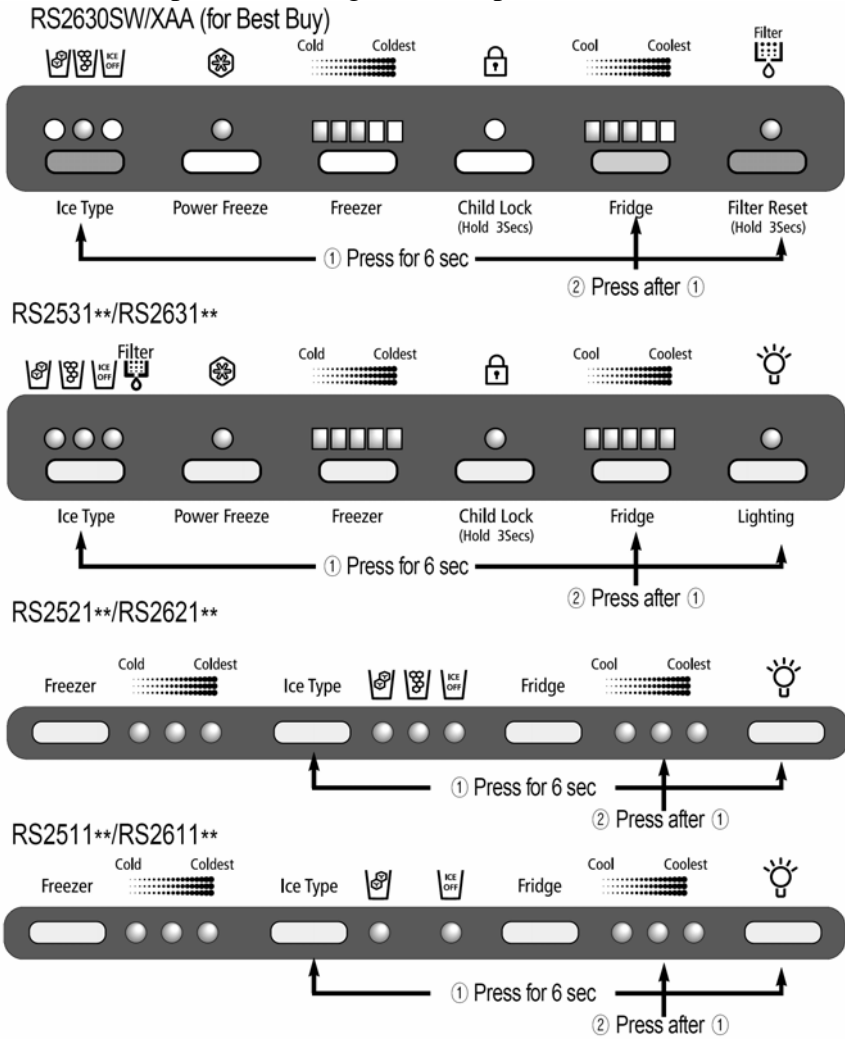

This allows the technician to see which components are active. This function will time out or the unit can be unplugged and then plugged back in to exit the load status and return to normal run operation.

Option Setting

It is strongly recommended that the temperature offsets are not adjusted. With that being stated, there will be rare instances when a customer insists that the temperature offset be adjusted to match a perceived performance issue whether the perception is correct or not. This would be a situation where the center set point of the range needs to be changed to satisfy operating expectations.

The first step before beginning an adjustment is to determine what the adjustment will be. If the center set-point of the range is providing a fresh food compartment temperature of 37 degrees and the expectation is that the temperature in the center of the range should be 35 degrees, the setpoint needs to be adjusted -2 degrees. If the center range of the freezer is set to -4 degrees and the desired setpoint is 0 degrees, the offset must be adjusted +4 degrees.

Since the refrigeration control has a limited system for display of temperature and function information, the adjustment of the default settings can be difficult to understand. This is compounded by the fact that there are different displays used for the different models of refrigerators. While adjusting an option, some of the LEDs on the display will indicate the option being adjusted while other LEDs will indicate the setting being applied to the option.

The two options we are concerned with are the Fresh Food setpoint option and the freezer setpoint option. Refer to the following maps to reference the model refrigerator that is being serviced. Note that on some models, the dispenser LEDs are used to help display important information. The dispenser LEDs are the blue LEDs used to illuminate the dispenser area for nighttime operation.

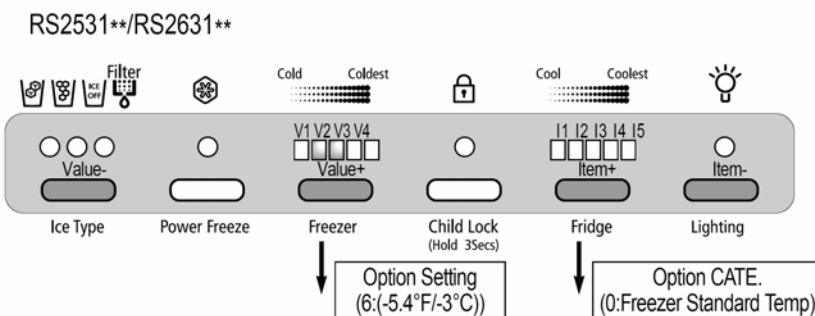
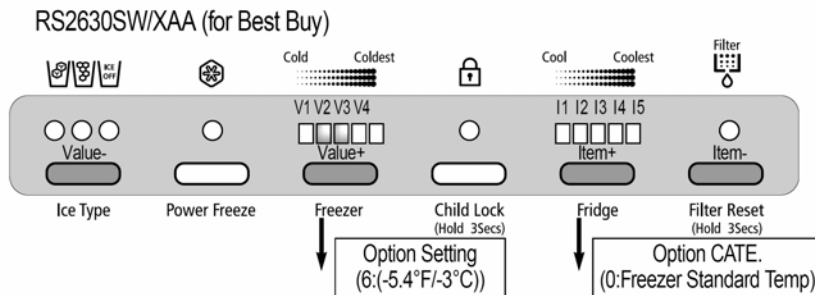

APP .EX) TO INCREASE REFRIGERATOR STANDARD TEMP BY (2.7°F/1.5°C)

RS2630SW/XAA (for Best Buy)

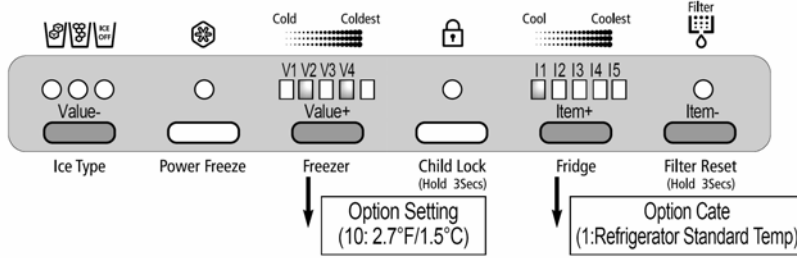

RS2531**/RS2631**

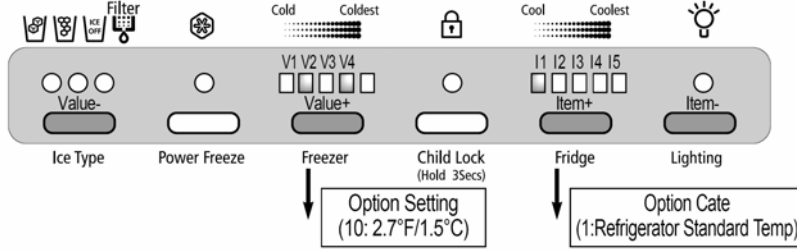

APP .EX) TO LOWER FREEZER STANDARD TEMP BY (-5.4°F/-3°C).

RS2521**/RS2621**

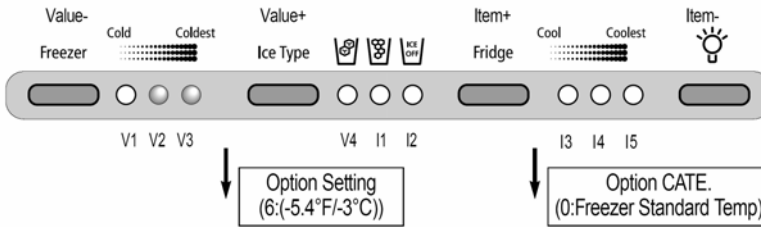

APP .EX) TO INCREASE REFRIGERATOR STANDARD TEMP BY (2.7°F/1.5°C)

RS2521**/RS2621**

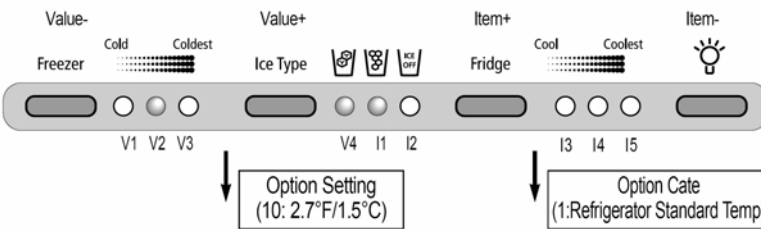

APP. EX) TO LOWER FREEZER STANDARD TEMP BY (-5.4°F/-3°C).

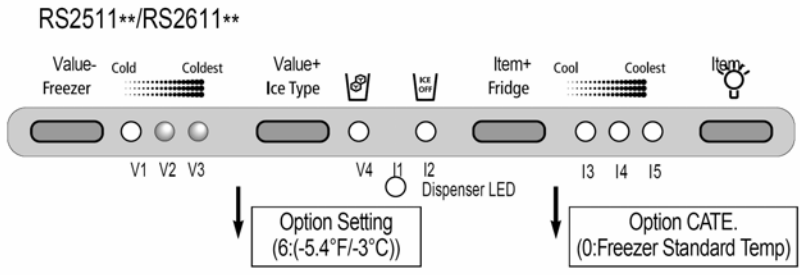

APP. EX) TO INCREASE REFRIGERATOR STANDARD TEMP BY (2.7°F/1.5°C)

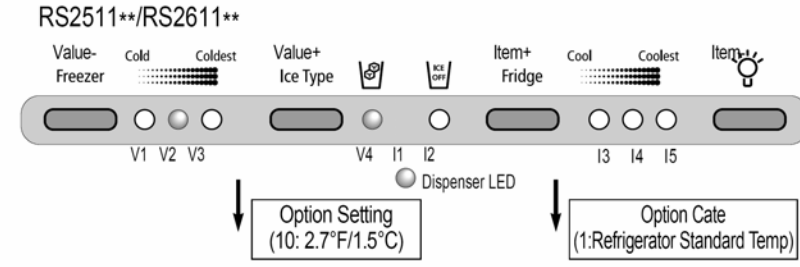

The LEDs are labeled I1 through I5 and V1 through V4. The I LEDs will illuminate to indicate the option being adjusted and the V LEDs will illuminate to indicate the offset that is applied to that option.

To enter the option setting mode, press the freezer and the furthest right control buttons at the same time and hold for twelve seconds.

RS2630SW/XAA (for Best Buy)

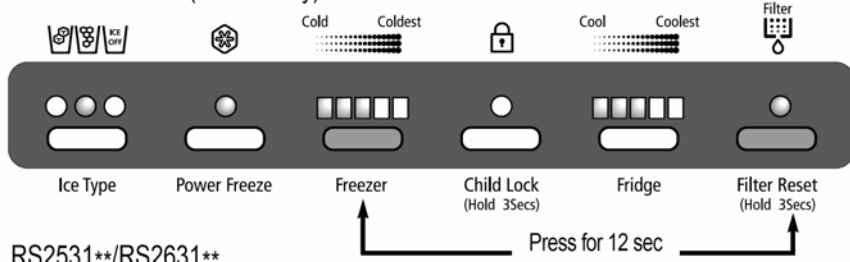

RS2531**/RS2631**

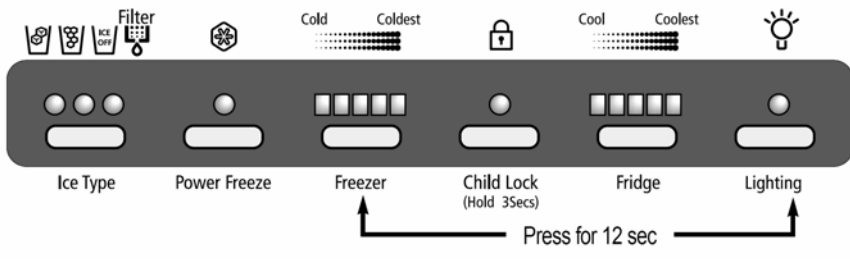

RS2521**/RS2621**

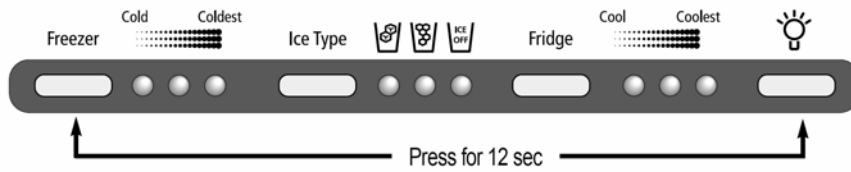

RS2511**/RS2611**

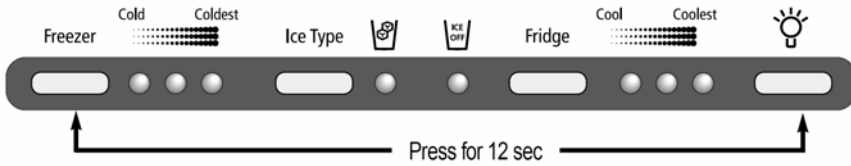

The initial state that the option settings come up as is the freezer temperature offset. In most cases there will be no LEDs illuminated. On control systems that include six buttons, the two rightmost buttons will change the category that is being adjusted. The I LEDs will illuminate to indicate the ITEM being adjusted, if none of the I LEDs are lit; the freezer offset is being adjusted. If I1 is lit, the fresh food offset is being adjusted. On four button control systems the two leftmost buttons either increase or decrease the setting for the option. On six button control panels, the first and third buttons from the left are used to change the offset value. The V LEDs will illuminate to indicate the VALUE of the current offset setting. Refer to the table to identify the offset temperature VALUE that corresponds to the illuminated LEDs. Normally this will be set at 0 with no LEDs lit. Adjust the VALUE until the desired setting is displayed. The VALUE will be stored in memory after twenty seconds of inactivity.

	RS2 *1 *	RS2 *2 *	RS2 *3 *
I1	DIS PENSER LED	CRUSHED(ICE)	FRIDGE MIN
I2	NO ICE	NO ICE	FRIDGE MID-M IN
I3	FRIDGE MIN (COLD)	FRIDGE MIN (COLD)	FRIDGE MID
I4	FRIDGE MID	FRIDGE MID	FRIDGE MID-M AX
I5	FRIDGE MAX (COLDEST)	FRIDGE MAX (COLDEST)	FRIDGE MAX
V1	FREEZER MIN	FREEZER MIN	FREEZER MIN
V2	FREEZER MID	FREEZER MID	FREEZER MID-MIN
V3	FREEZER MAX	FREEZER MAX	FREEZER MID
V4	CUBED (ICE)	CUBED (ICE)	FREEZER MID-MAX

(For the Value Spec, the Dispenser LED is used due to the insufficient number of panel LEDs.)

1) FREEZER TEMP SHIFT TABLE(○: RELEVANT LED OFF, ●: RELEVANT LED ON)

SET ITEM		Freezer TEMP SHIFT																	
MODEL		AD -PJT																	
DISPLAY Option Item		VALUE	I1	I2	I3	I4	I5												
		0	○	○	○	○	○												
SET VALUE		COMMON					SET VALUE					COMMON							
Option Value							Option Value												
VALUE	V1	V2	V3	V4						VALUE	V1	V2	V3	V4					
0	○	○	○	○	0°F/0°C	8	○	○	○	●	0.9°F/+0.5°C								
1	●	○	○	○	-0.9°F/-0.5°C	9	●	○	○	●	1.8°F/+1.0°C								
2	○	●	○	○	-1.8°F/-1.0°C	10	○	●	○	●	2.7°F/+1.5°C								
3	●	●	○	○	-2.7°F/-1.5°C	11	●	●	○	●	3.6°F/+2.0°C								
4	○	○	●	○	-3.6°F/-2.0°C	12	○	○	●	●	4.5°F/+2.5°C								
5	●	○	●	○	-4.5°F/-2.5°C	13	●	○	●	●	5.4°F/+3.0°C								
6	○	●	●	○	-5.4°F/-3.0°C	14	○	●	●	●	6.3°F/+3.5°C								
7	●	●	●	○	-6.3°F/-3.5°C	15	●	●	●	●	7.2°F/+4.0°C								

2) REFRIGERATOR TEMP SHIFT TABLE(○: RELEVANT LED OFF, ●: RELEVANT LED ON)

SET ITEM		Refrigerator TEMP SHIFT																	
MODEL		AD -PJT																	
DISPLAY Option Item		VALUE	I1	I2	I3	I4	I5												
		1	●	○	○	○	○												
SET VALUE		COMMON					SET VALUE					COMMON							
Option Value							Option Value												
VALUE	V1	V2	V3	V4						VALUE	V1	V2	V3	V4					
0	○	○	○	○	0°F/0°C	8	○	○	○	●	0.9°F/+0.5°C								
1	●	○	○	○	-0.9°F/-0.5°C	9	●	○	○	●	1.8°F/+1.0°C								
2	○	●	○	○	-1.8°F/-1.0°C	10	○	●	○	●	2.7°F/+1.5°C								
3	●	●	○	○	-2.7°F/-1.5°C	11	●	●	○	●	3.6°F/+2.0°C								
4	○	○	●	○	-3.6°F/-2.0°C	12	○	○	●	●	4.5°F/+2.5°C								
5	●	○	●	○	-4.5°F/-2.5°C	13	●	○	●	●	5.4°F/+3.0°C								
6	○	●	●	○	-5.4°F/-3.0°C	14	○	●	●	●	6.3°F/+3.5°C								
7	●	●	●	○	-6.3°F/-3.5°C	15	●	●	●	●	7.2°F/+4.0°C								

Damper Access

To remove the refrigerator light cover and gain access to the damper and thermistor, remove the upper shelf then remove the light lens cover by pulling down on the tab at the back of the lens cover. Remove two Phillips screws and pull the assembly down. Disconnect the damper, Thermistor and light harnesses and pull the assembly outward. To remove the damper, cut and remove tape and separate the foam cover, remove tape covering the damper harness and remove the damper. To remove the thermistor cut the tape around the edges, lift the Styrofoam insulation up and remove Thermistor.

Ice Maker Removal

To remove the ice maker grasp ice bin at the bottom and lift up and out. Shelves are being removed for later access to the evaporator cover. Remove two screws holding the ice maker in. Drop the ice maker down and disconnect the ice maker harness. To remove the auger assembly, remove two screws on either side and one in the ceiling of the freezer. Slide the auger assembly forward to disconnect the wiring harness and remove complete auger assembly by pulling it forward.

Ice Maker Operation

The ice maker tray capacity is 95 CC. The AD model uses eight cubes not seven as the previous model. The AD Model does not use a flow sensor. Water flows a few times initially to measure the amount of water in the tray and the microprocessor memorizes the required flow time, which will be between 5 and 8 seconds.

During Ice-making operation the freezer compartment temperature will override to -13 degrees F. After the ice bucket is full the freezer temperature will rise to the set temperature. Selecting the no ice mode will also save energy.

Evaporator Section

To gain access to the evaporator section, remove four Phillips screws and unsnap the middle section of the evaporator cover. At this time the lower section of the evaporator cover can now be removed. To remove the defrost heater assembly, remove two Phillips screws and slide the heater assembly forward. Remove the heater harness running up the left and right side of the evaporator coil. Remove two screws that hold the fan bracket in place, disconnect the fan harness and remove the fan assembly. Cut wire ties and disconnect the heater harness from the cabinet. The heater being used glass tube heater. The defrost terminator is located on the left side of the evaporator, just over half way up. Replacement terminator will include the harness and connector.

High Voltage Checks

The high voltage board is located in the rear of the refrigerator on the lower left side. Remove two Phillips screws then remove the cover to gain access to the board. Some of the common voltage checks include:

Power into the transformer, line voltage should be present at this location. Voltage out of the transformer at connector CN10, pins 1 and 3, should be approximately 17.4 volts AC. Voltage into the high voltage board at connector CN71 pins 3 and 9 should be line voltage. Voltage out to the condenser fan motor at L1 to pin 7 of connector CN71, should be line voltage when energized. Voltage out to the evaporator fan motor at L1 to pin 1 of connector CN71, should be line voltage when the evaporator fan motor is energized. Voltage out to the compressor is checked at L1 to pin 13 of connector CN71, this should be line voltage when the compressor circuit is on.

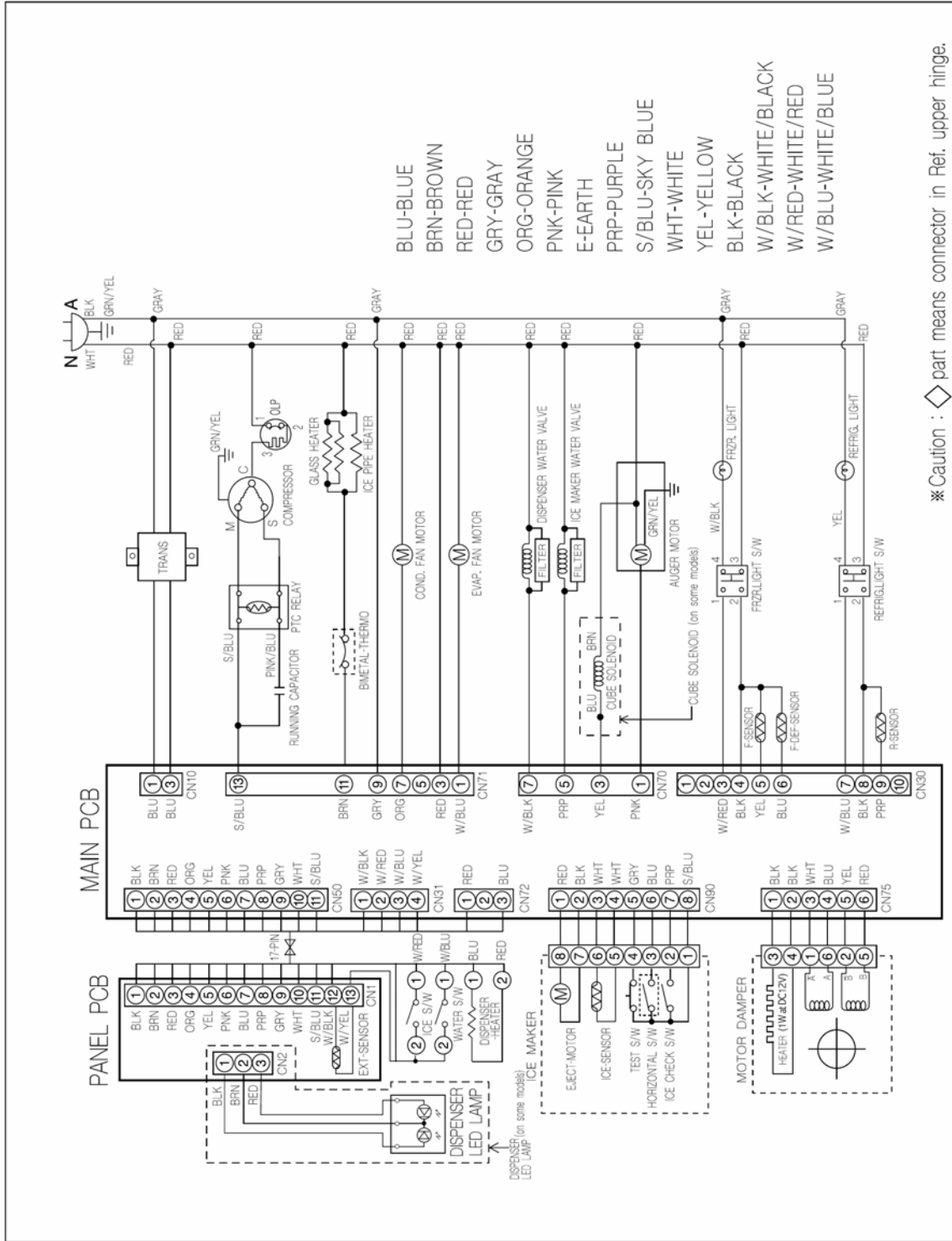

* Caution : ◇ part means connector in Ref. upper hinge.



***Be Aware, Be Alert
Always work safely.
On the Job, On the Road, In the Home
Every Time, All the Time***

**MAYTAG *Training*
SERVICES**