

INDEX

D1876 DISHWASHER (DW954)

● PROGRAMS	2
● ELECTRICAL FUNCTIONS	5
● PART NUMBER SUFFIX DEFINITIONS	7
● SPARE PARTS LIST	
.. Casing and related parts	8
.. Container and related parts	10
.. Door	12
.. Control Panel	14
.. Dishwashing system	16
● WIRING DIAGRAM	18
● TIMER DIAGRAM	19
● SERVICE INFORMATION	
.. Door springs	20
.. Water level	21
.. Door lock	22
.. Control unit failure analysis	23
.. Remaining time indication	24

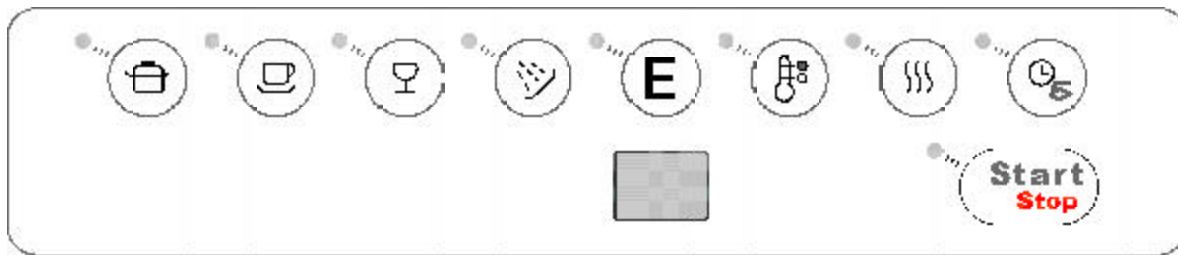

PROGRAMS

PROGRAM	DEFINITION
Pots and pans/Sani	Two prewashes, main wash, three rinses* and drying.
Normal	Two prewashes, main wash, two rinses* and drying.
Quick Rinse	Main wash, two rinses, heated drying.
	One rinse at 131°F (55°C). If Heat fan dry is selected, the heating element will activate. Drying: 158°F (70°C)

* The Pots and Pans/Sani and Normal programs can be programmed for an extra rinse (see page 3). In that case, the temperatures for the next-to-last rinse would be the household water temperature and the final rinse would be the last rinse temperature indicated in the table below.

OPTIONS

Temperature	Lets you select high or low water temperatures for the wash programs (except Rinse). (See the table below.) The indicator light glows red when it's on the High setting and remains off when set on Low.
Heat Fan Dry	Pressing this touchpad activates the heating element along with the turbo fan for 12 minutes after the final rinse. (158° F/70° C)
Time Delay	Press this touchpad to delay starting the unit for five hours.
Start/Stop	Press this touchpad to Start or Stop the machine. To interrupt a program, hold this touchpad down for three seconds.

WASH PROGRAM TEMPERATURES

Wash Program	Temp	1st Prewash	2nd Prewash	Main Wash	1st Rinse	2nd Rinse	3rd Rinse
Pots & Pans/Sani	Low	113°F (45°C)	House	131°F (55°C)	House	House	131°F (55°C)
	High	113°F (45°C)	House	158°F (70°C)	House	House	149°F (65°C)
Normal	Low	86°F (30°C)	House	131°F (55°C)	House	131°F (55°C)	n/a
	High	86°F (°30C)	House	149°F (65°C)	House	149°F (65°C)	n/a
Quick	Low	House	n/a	113°F (45°C)	House	113°F (45°C)	n/a
	High	House	n/a	131°F (55°C)	House	131°F (55°C)	n/a

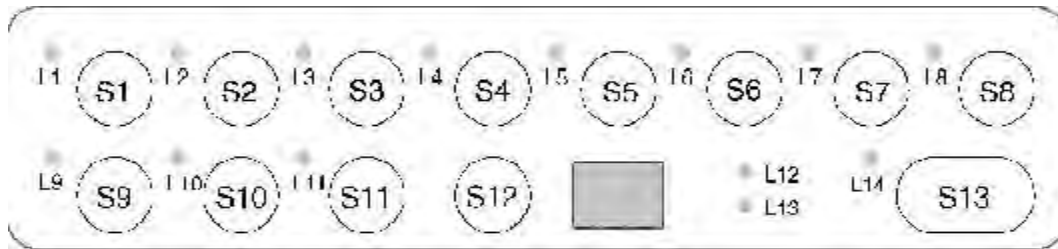

S = Pushbutton switch

L = Indicator light

EXTENDING FAN COOLING TIME

To extend the fan cooling time, **press S1 five times then press** one of the following:

S5 for 30 extra minutes

S4 for normal fan cooling time

SETTING AN EXTRA RINSE

To add an extra rinse to the Pots and Pans and Normal wash programs, **press S2 five times then press** one of the following:

S5 for an extra rinse

S4 for the normal number of rinses

SETTING CHILD-SAFE START FUNCTION

The start function can be reprogrammed so that the button must be pressed in for 3 seconds to start the programs. To do this, **press S4 five times then press** one of the following:

S5 to get a prolonged start function or

S4 to get a normal start function.

SETTING PUMP-OUT TIME

If it's necessary to reprogram the pump-out time, you can do so by **pressing S3 five times then pressing** one of the following:

Press:	to get an outlet time of:
S3	20 seconds
S4	25 seconds (factory setting)
S5	35 seconds
S6	45 seconds
S7	85 seconds

SETTING INLET TIME

You can reprogram the inlet time on level controlled and time controlled inlets. To do this, **press S5 five times then press** one of the following:

Press:	to get an inlet time of:
S3	45 seconds (factory setting)
S4	56 seconds
S5	68 seconds
S6	90 seconds
S7	113 seconds
S8	180 seconds

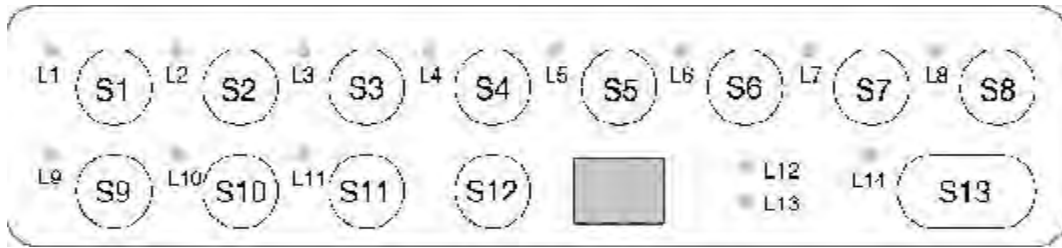

S = Pushbutton switch

L = Indicator light

FAULT CODES

Blinking lights and an F-code in the LED window indicate a machine fault.

Code	Blinking Lights	Problem
F1	L3 and L7	Heating element
F2	L1–L8	Overfill
F3	L4 and L5	Thermistor fault (heater control)
F4	L1–L4	Water inlet

FAULT-TRACING PROGRAM

The functions of the electrical components can be tested by **pressing S6 five times then pressing** one of the following:

Press	to test
S3	inlet valve 1
S4	combi-dispenser
S5	heating element
S6	circulation pump
S7	outlet pump
S8	fan motor and wax motor

Stop the fault-tracing program by pressing S13.

LINKS ON THE PROCESSOR BOARD (for program variations)

These diodes should be cut for proper U.S. installation:

Link USA: USA processor board layout

CONTROL PANEL (see page 15)

The control panel contains a microprocessor for control of programs, circulation pump, inlet valves, etc. It also allows for custom settings of programs (see page 3).

CIRCULATION PUMP/MOTOR (see page 17)

The circulation pump/motor consists of a synchronous motor and pump, constructed in an integrated unit. A 16 μ F capacitor is fitted to the circulation motor/pump.

OUTLET PUMP (see page 17)

The outlet pump consists of a synchronous motor and pump, constructed in an integrated unit.

INLET VALVE (see page 17)

A single-unit type: A solenoid and valve seat.

HEATING ELEMENT (see page 11)

1400 Watt

THERMISTOR (see page 11)

The thermistor controls the water temperature within $\pm 1^{\circ}\text{C}$ (2.5°F) to give the required temperature. The heater will be disconnected if the thermistor is short-circuited or loosened from the circuit board and the fault code "F3" displays in the LED window. The normal resistance of the thermistor is between 25 and 15K ohm at 68°F (20°C) or 86°F (30°C) alternately.

OVERHEAT PROTECTION (see page 11)

The thermostat has a switch-off function at 190°F (88°C) that prevents the heating element from staying on if the control unit or the timer should fail.

DOOR SWITCH (see page 17)

A microswitch senses that the door has been opened. This interrupts the program and cuts the power to all control components (motor, valves, etc.).

LEVEL SWITCH (PRESSURE SWITCH) (see page 11)

This switch protects against overfilling by interrupting the power to the inlet valve and starting the outlet pump. If the water level has not dropped within 30 seconds or if overfill has occurred twice during the same program, the program will be terminated and a fault code displays. The overfill protection operates during all programs, including fault-tracing, even if the microprocessor is faulty.

OVERFILL SWITCH (see page 11)

A float in the base pan influences a microswitch that disconnects the inlet valve and starts the outlet pump.

COMBI-DISPENSER (see page 13)

The combi-dispenser dispenses both detergent and rinse aid. The dispenser has an adjustable volume chamber for setting the desired amount of rinse aid.

TURBO FAN (see page 13)

The turbo fan evacuates the moist air from the machine during the drying phase of the program. The fan system consists of a fan motor that runs a two-part impeller. Dry, cool air is pulled in from the door into one of the impeller halves. A wax motor opens a damper and the moist air is pulled into the other part of the impeller. The dry, cool air and warm, moist air mix and condense in the condensation chamber. The condensed moisture then drains through the channel to the lower sump area. Dry air is then vented out through a channel below the outer door.

ELECTRICAL SUPPLY

The machines are wired for connection to a single-phase, 120V, 15A supply, with a heater power of 1400W, giving a total power requirement of 1600W.

VALUES FOR WIRING DIAGRAMS

Resistance values at 68° F (+/-5°F), 20° C (+/-3°C)

(Values within +/- 10% is normal.)

AP	Drain pump	120V, 60 Hz, 25.5 ohm
BB	Illumination switch	
CP	Main pump	120 V, 60 Hz, Main = 10.5 ohm, Aux = 14.5 ohm
KD	Combi-dispenser	120 V, 0.31 ohm
EL	Heating element	120 V, 1400 W, 10 ohm
M	Inlet valve	120 V, 9.93 K ohm (1-3, 2-4)
FL	Fan	120 V, 0.25 K ohm
LB	Door switch	
LU	Door	
N	Level switch	
P	Control unit	
R	Relay	230 V Eberle, 0.59 K ohm
T	Thermostat	19–25 K ohm
TB	Pushbutton switch	
TTE	Temp. thermistor	19–25 K ohm
WAX	Wax motor	1.5–3.0 K ohm
OB	Overflow switch	

The lists below define the meanings of the dashed numbers or letters following a part number:

Colors:

- 0 White
- 29 Black, bright
- 33 Black
- 36 Dark grey
- 49 Helios grey
- 69 black, metallic
- 77 grey
- 81 metallic
- 95 Stainless Steel

Note: Not all colors are available for all parts.

Doors

- M for units with fan
- P for integrated units
- R for decor frames, long deviation
- S for decor frames, short deviation
- T for decor frames with adjustable lower part

Date 2000-06	CASING AND RELATED PARTS	Page 8
------------------------	---------------------------------	------------------

--	--	--

Date		CASING AND RELATED PARTS		Page
2000-06				9
Fig.	Qty	Part No.	Description	Notes
1	1	80 583 53	Sound insulation	
2	1	80 600 41	Sound insulation profile	
3	1	80 575 26	Guard plate	
	4	89 003 52	Screw	RTS ST 4.2x13
4	1	80 707 43	Felt, kick plate	
5	1	80 597 58-	Kick plate	-0, -29, -81
	2	89 009 44-	Screw, kick plate	-0, -29, -81
6	1	80 706 15	Sealing strip	
	1	80 571 00-	Lower cover	-S-0, -S-29, -95
	2	89 003 52	Screw	RTS ST 4.2x13
	4	80 097 69-	Plug for decorframe	-0, -33
8	1	80 706 12	Sound insulation	
9	1	80 584 86	Drip protection for guard plate	
10	2	80 575 49	Bracket, kick plate	
11	2	80 575 50	Spring, kick plate	
	2	89 003 27	Screw	RTS ST 4.2x13 FZB T20

Date 2000-06	CONTAINER AND RELATED PARTS	Page 10
------------------------	------------------------------------	-------------------

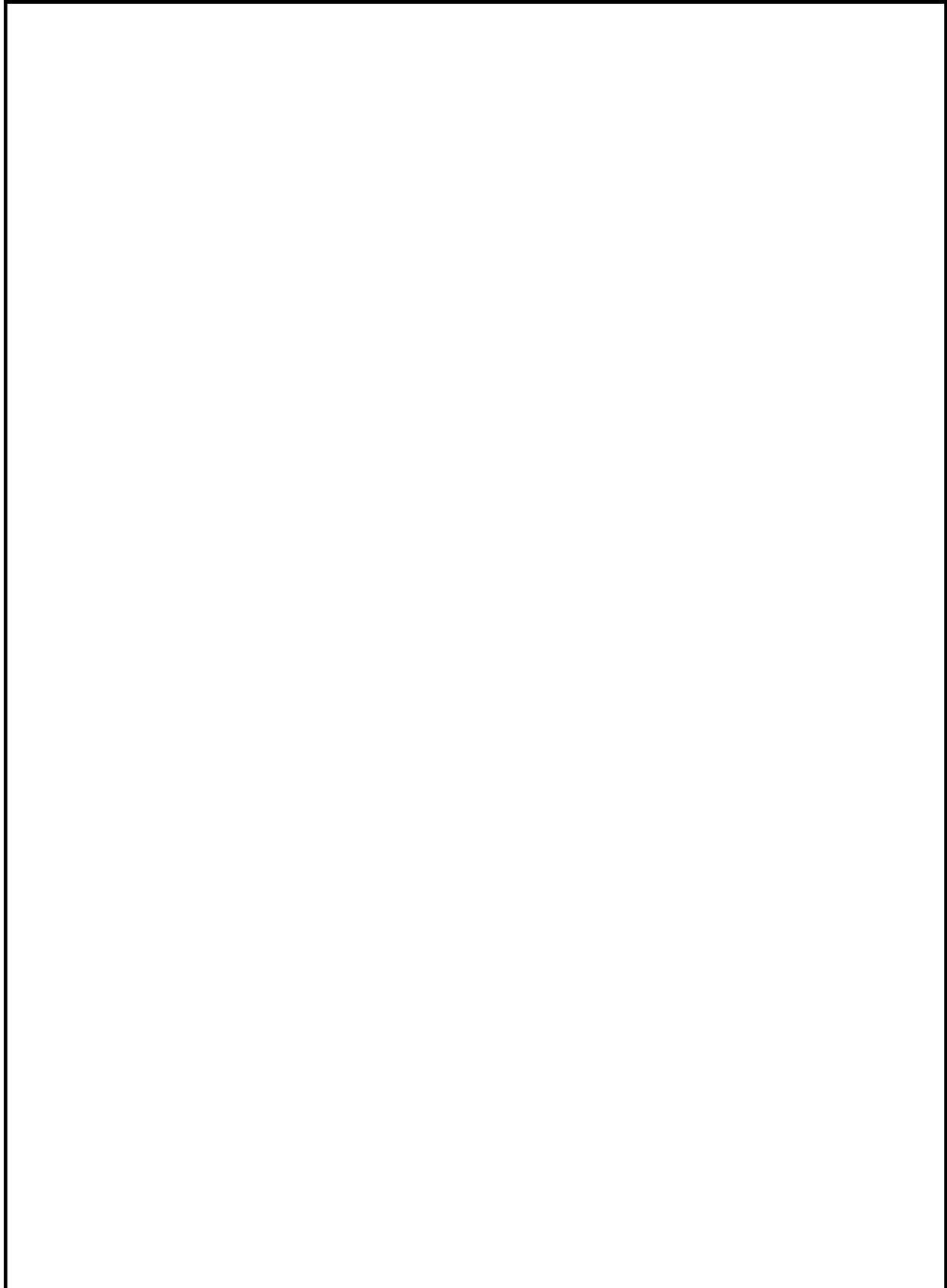

Date		CONTAINER AND RELATED PARTS		Page
2000-06				11
Fig.	Qty	Part No.	Description	Notes
2	1	80 706 13	Sealing strip, casing top	
3	1	80 574 89	Tub seal	
4	1	88 010 98	Lock catch compl.	
5	2	80 579 78-	Ball catch	-77
6	2	80 586 38-	Ball bearing holder, guide rail	-77
7	8	80 579 77	Ball bearings	
8	2	80 579 79-	Basket stop	-77
9	2	80 570 52	Guide rail	
10	1	80 600 33	Sound insulation	
11	4	89 011 10	Screw + O-ring	A2-M6x12 T30
12	1	80 570 77	Heating element	1400 W 120 V
	1	80 602 58	Cable holder	For heating
	2	80 023 70	Protection collar, heating	
14	1	80 584 95	Cable holder, door	
15	1	80 701 42	Cable holder	
16	1	80 025 79	Thermostat	Overheat protection
17	1	80 597 61-	Strip side, left	-0, -29, -95
	1	80 597 62-	Strip side, right	-0, -29, -95
	4	89 006 46	Screw	A4 RTS 4.2x13 T20
	2	89 003 52	Screw	RTS ST 4.2x13
18	2	80 706 14	Sealing strip	
19	1	80 575 23	Bottom outer	
	2	89 011 04	Screw, casing - bottom	A2-MRT-TT 4x8 T20
20	2	80 584 91-	Door springs compl.	-77
21	1	80 704 95	Mount, inlet valve	
	2	89 003 27	Screw	RTS ST 4.2 x 13 FZB T20
22	1	80 602 55	Mount, electrical connection	
23	1	80 599 91	Cable holder	
24	1	80 069 48	Grommet	
25	1	80 585 58	RFI filter	
26	1	80 502 51	Terminal block	3-pole
	1	89 003 57	Screw, terminal block	RTS ST 4.2x25 FZB T20
	1	89 021 31	Screw, grounding terminal bl.	MRT-TT 4x6 FZB T20
	1	89 014 13	Washer	AZ 4,3 FZB
27	4	80 721 19	Reinforcement washer	
28	4	80 570 62	Leveling leg	M10x100, 8.8 FZB
29	4	89 011 56	Nut	M6M10 BH8 FZB
30	2	80 519 57	Slide foot, rear only	

Date 2000-06	DOOR	Page 12
-----------------	-------------	------------

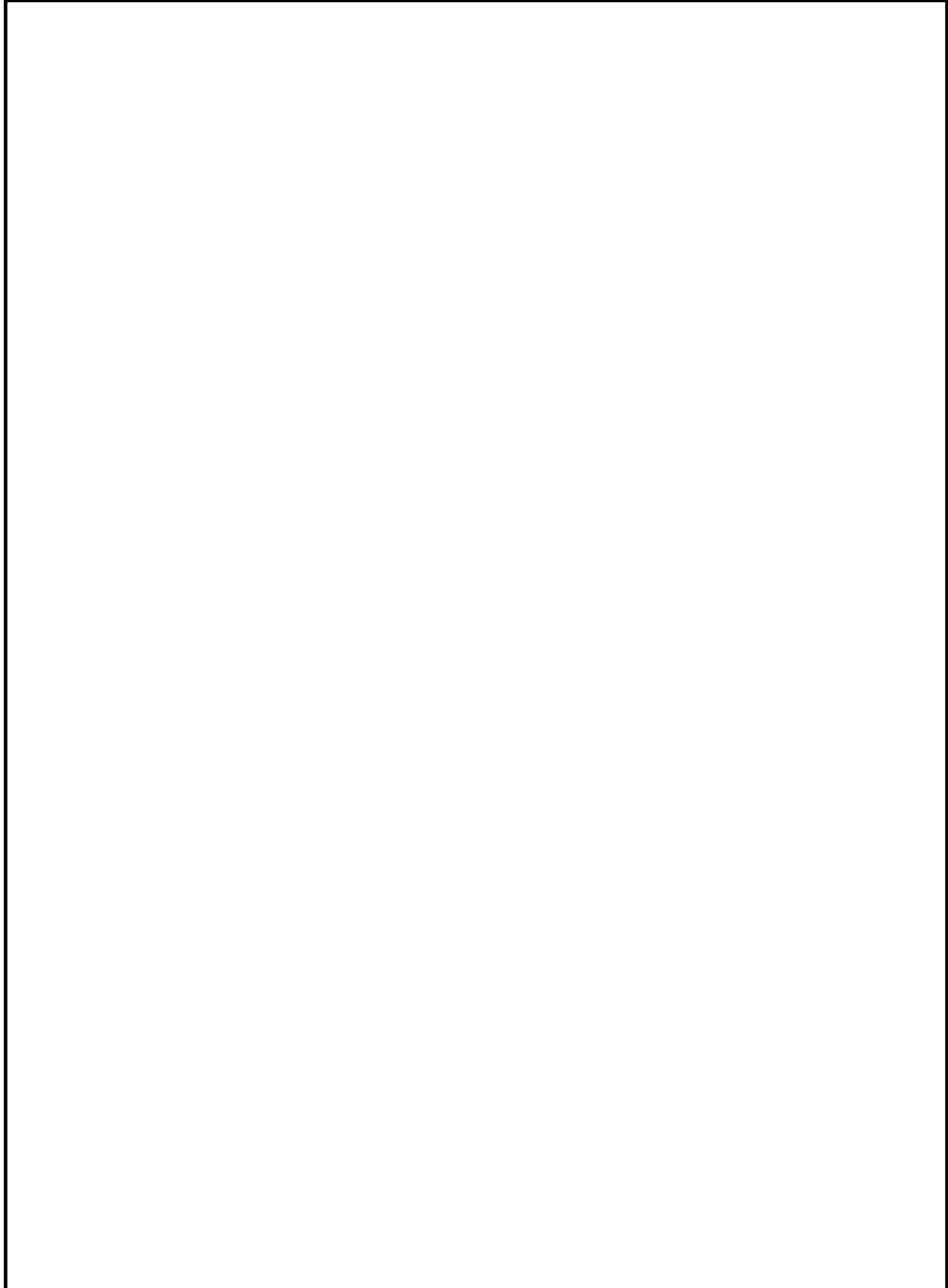

Date				Page
2000-06		DOOR		13
Fig.	Qty	Part No.	Description	Notes
1	1	80 527 78	Wax motor	
2	1	80 585 01	O-ring	
3	1	80 600 21	Fan, compl.	
4	1	80 579 63-	Air channel, turbo dry	-S
5	1	80 727 29-	Nozzle, air channel	-0, -33
6	1	88 011 18	Inner door compl.	
	4	89 021 20	Screw	A2-MKFT 5x10-TT FZB
7	1	80 579 64	Lock ring, fan casing	
8	1	80 584 84	Cover plate, fan	
	2	89 020 85	Screw, fan cover plate	A2-PTK 40x10 WN1452
9	1	80 706 80-	Combi-dispenser	-77
	6	89 020 87	Screw	PTK 40x14 WN1452 FZB
	1	80 719 17	Rinse aid cap	
	1	80 719 18	Combi-dispenser lid	Incl. seal and spring
10	1	80 575 25	Hinge, left	
	1	80 575 24	Hinge, right	
	2	80 575 30	Hinge screw	
	2	33500262	Nut, hinge bearing, locking	4 BH8 FZB
11	2	80 579 48	Slide washer, hinge bearing	
12	1	80 715 87	Holder, cable harness	
	1	89 021 31	Screw, cable harness holder	MRT-TT 4x6 FZB T20
13	1	80 584 87	Stay, air channel	
14	1	80 579 85	Brace stand	
	2	89 006 46	Screw, lower stay	A4 RTS 4.2x13 T20
15	1	80 602 54	Door seal lower	L=555 mm
16	1	80 702 94	Sound insulation	
17	1	80 579 86-	Door outer part	-S-0, -S-29, -95
	6	89 006 46	Screw	A4 RTS 4.2x13 T20
	2	89 003 27	Screw	RTS ST 4.2x13 FZB T20
	2	80 561 17-	Screw	-29
	6	80 097 69-	Plug for decor frame	-33

Date
2000-06

CONTROL PANEL

Page
14

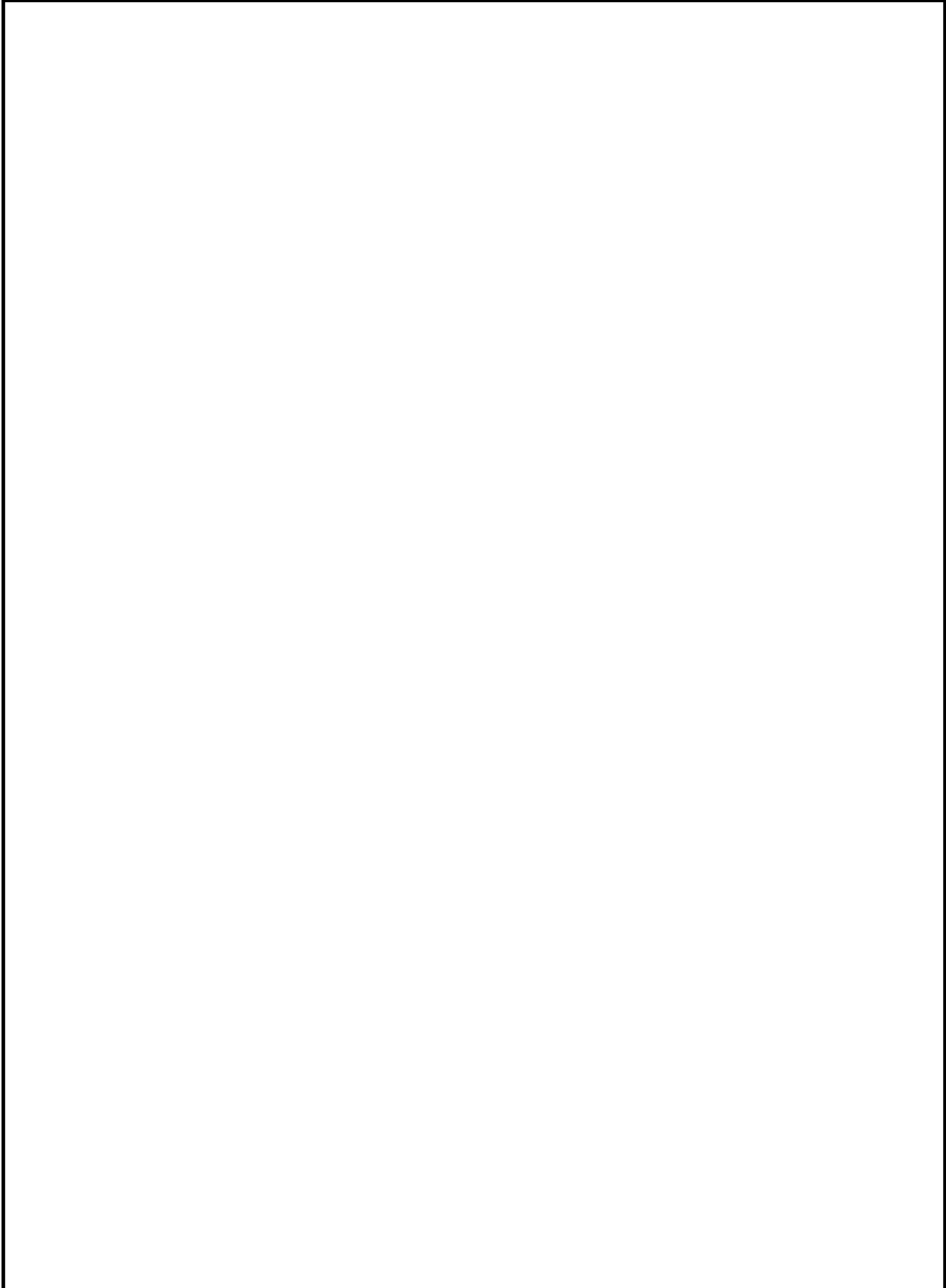

Date		CONTROL PANEL		Page
2000-06				15
Fig.	Qty	Part No.	Description	Notes
1	1	80 575 41-	Handle	-0, -33, -81
2	1	80 575 45	Safety catch	
3	1	80 575 46	Spring, safety catch	
4	1	80 575 44	Control arm, safety catch	
5	1	80 575 39	Holder, handle assembly	
	2	89 020 85	Screw	A2-PTK 40x10 WN1452
	2	89 020 87	Screw	PTK 40x14 WN1452 FZB
6	1	80 710 98	Cover, microswitch	
7	1	80 554 73	Microswitch	
8	1	80 575 42	Control pin, microswitch	
9	1	80 070 78	Spring, handle	
10	1	80 575 37-	Front panel	-0, -69, -81
11	1	80 575 38-	Backing for decor plate	-0, -69, -81
	1	89 020 92	Screw	PTK 40x25 WN1452 FZB
12	1	80 734 08-	Decor insert	-0, -33, -81
13	1	80 600 76	Contact cover	
14	1	88 012 01	Control unit	
	2	89 020 53	Screw	PTK 40x45/15 FZB T20
15	1	80 597 67	Thermistor	
16	1	80 734 52	Cable harness complete	
	1	80 730 96	Use and Care Guide	

Date 2000-06	DISHWASHING SYSTEM	Page 16
-----------------	---------------------------	-------------------

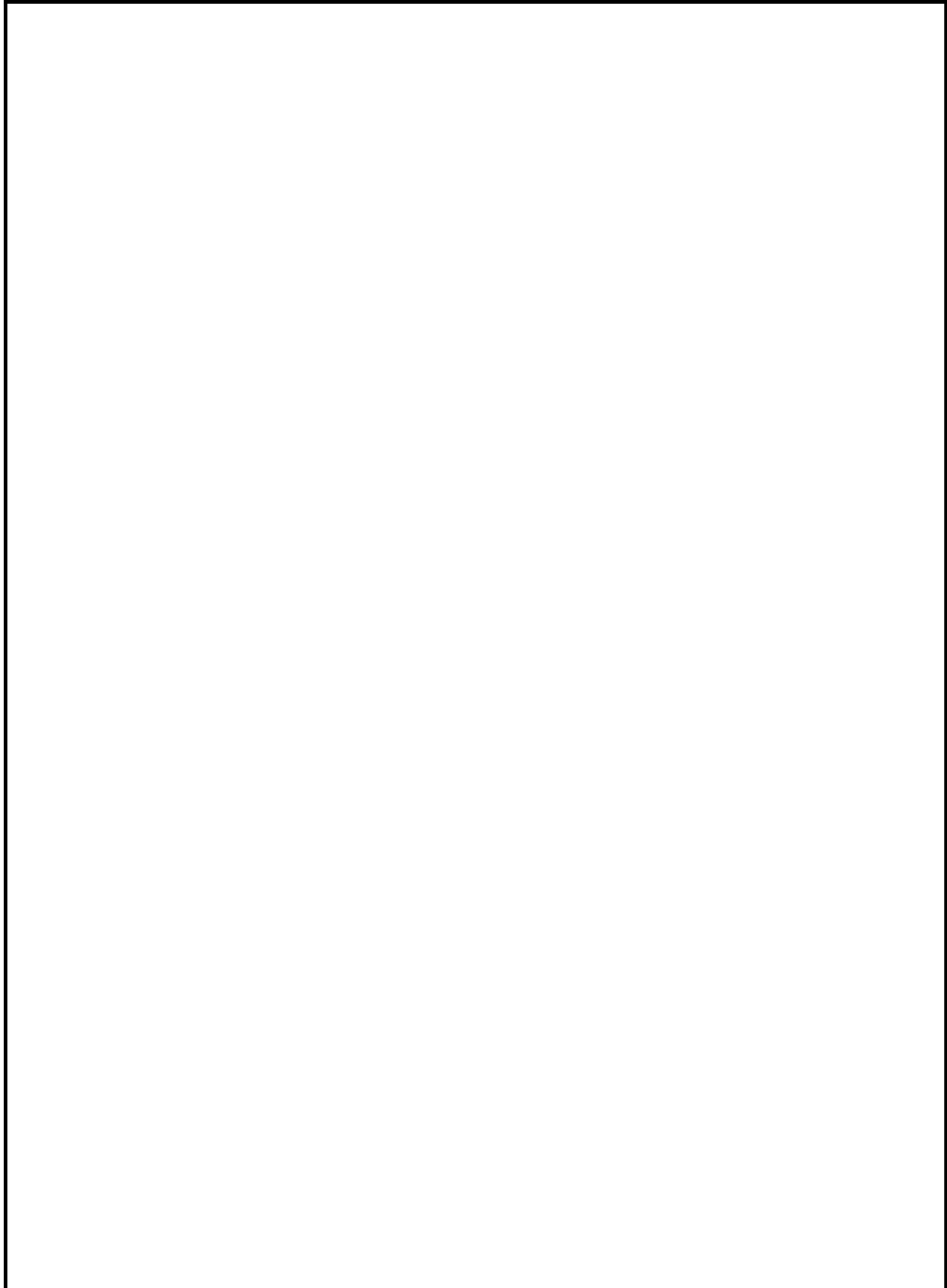

Date		DISHWASHING SYSTEM		Page
2000-06				17
Fig.	Qty	Part No.	Description	Notes
1	1	80 713 37-	Cup shelf, wine glasses	-36
2	1	80 011 99-	Upper basket, w/wheels *	-36, with cup shelf
3	1	80 713 36-	Cup shelf	-36
4	1	80 575 36-	Lock ring, air break	-77
5	1	80 585 04	O-ring, inlet air break	
6	1	80 575 14	Air break	
7	1	80 597 40	Strainer, upper part	
8	4	80 584 98-	Basket wheel, upper	-77
9	1	80 575 06-	Knife stop, upper basket	-77
	2	80 712 14-	Knifestand, upper basket	-77
10	1	88 010 89-	Cutlery basket	-77
11	1	88 012 00-	Lower basket	-36
12	8	80 095 16-	Basket wheel, lower	-77
13	1	80 584 93-	Lower basket insert	-36
14	1	80 703 04	Outlet hose	
15	1	80 726 95	Spray arm, upper	
16	2	89 012 62	Nut, spray arm bearing	
17	2	80 520 95	Washer, spray arm bearing	
18	2	80 570 70-	Spray arm bearing	-77
19	1	80 570 68-	Spray pipe bearing, upper	-77
20	1	80 570 63	Spray pipe	
21	2	80 521 89	Hose clip, inlet valve	17.0-706
22	1	80 585 02	Rubber hose, inlet valve	
23	1	80 721 21	Inlet valve	
	2	89 020 87	Screw	PTK 40x14 WN1452 FZB
24	1	80 726 92	Spray arm, lower	
25	1	80 570 67-	Spray pipe bearing, lower	-77
26	1	89 017 55	O-ring, lower spray pipe bearing	
27	1	80 570 69	Nut, spray pipe bearing	
28	2	80 574 84	Hose, circulation pump	
29	4	80 520 97	Hose clip, circ. pump hose	44.0-708
30	1	80 550 95	Rubber buffer, circ. pump	
31	1	80 710 24	Level switch (pressure)	
32	1	80 570 53	Float, base pan	
33	1	80 600 68	Microswitch float	
34	1	80 585 00	Rubber hose	5x8x340
35	1	88 011 23-	Bottom well, sump	-77
36	1	80 585 03	O-ring, bottom well, sump	109.5x3
37	1	80 574 87-	Cover plate	-33
38	1	80 025 84	O-ring, outlet pump	49.5x3
39	1	80 720 32	Outlet pump	
40	1	80 522 39	Hose clip	31.6-708
41	1	80 574 88	Lock ring, bottom well, sump	
42	1	80 584 54	Cover plate	
43	1	80 579 72-	Filter basket, coarse	-77
44	1	80 574 86-	Insert, filter basket	-77
45	1	80 712 50	Circulation pump	

*When ordering an upper basket, you also need to order the knife stop and knife stand (see Figure 9).

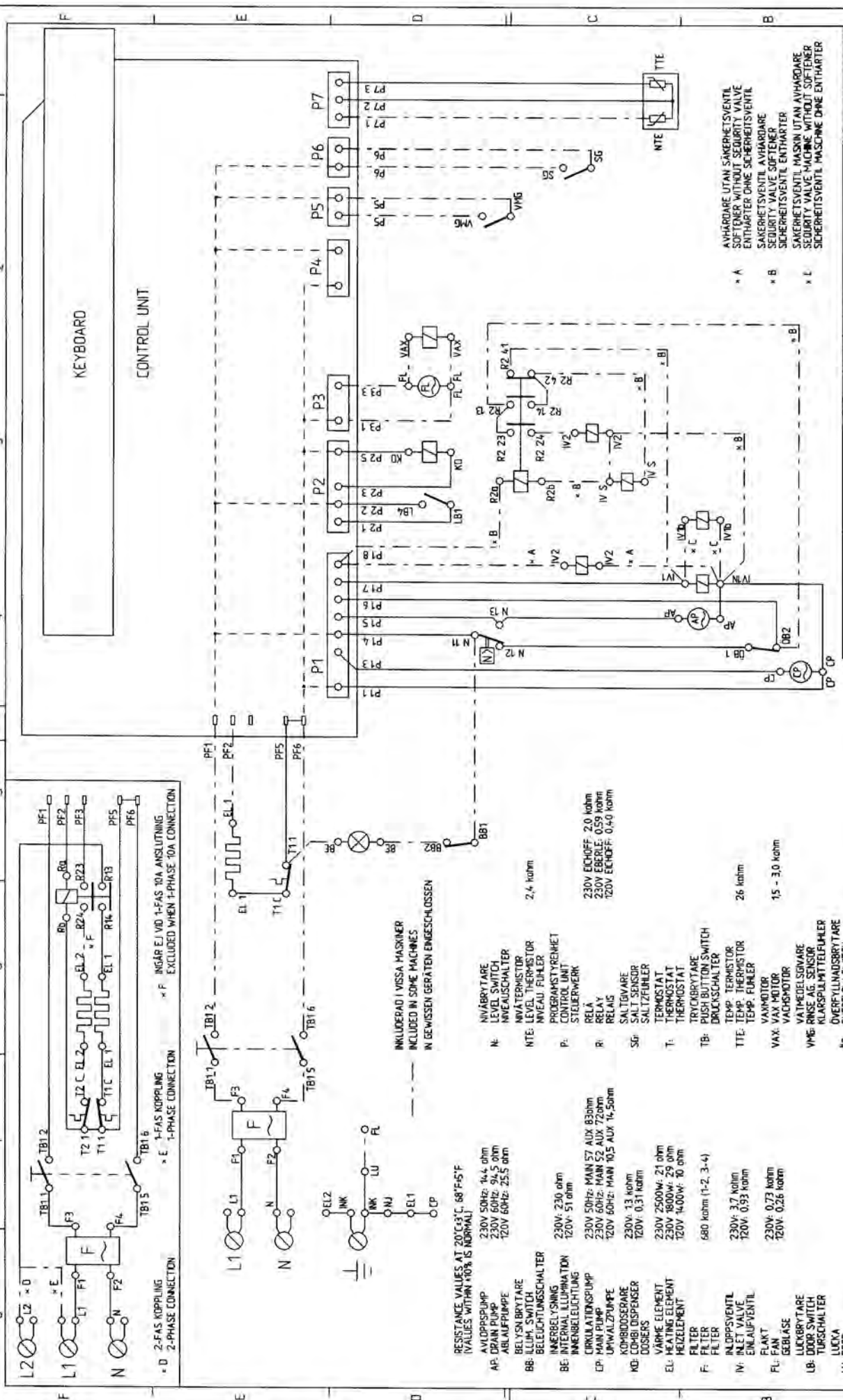

AVHÄRRE UTAN SÄKERHETSVENTIL
 SOFTENER WITHOUT SECURITY VALVE
 ENTHÄRTER OHNE SICHERHEITSVENTIL
 SÄKERHETSVENTIL AVHÄRRE
 SECURITY VALVE SOFTENER
 SICHERHEITSVENTIL ENTHÄRTER
 SÄKERHETSVENTIL MASJIN UTAN AVHÄRRE
 SECURITY VALVE MACHINE WITHOUT SOFTENER
 SICHERHEITSVENTIL MASCHINE OHNE ENTHÄRTER

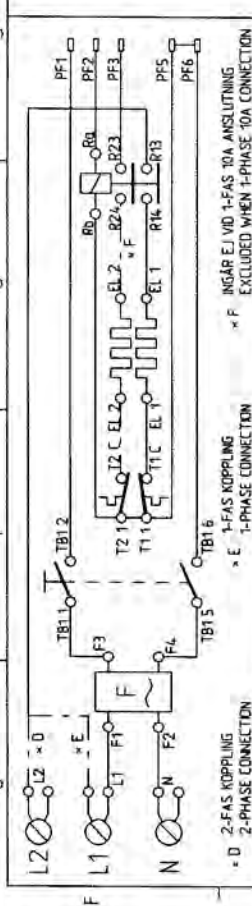

* D 2-FAS KOPPLING
 2-PHASE CONNECTION

* E 1-FAS KOPPLING
 1-PHASE CONNECTION

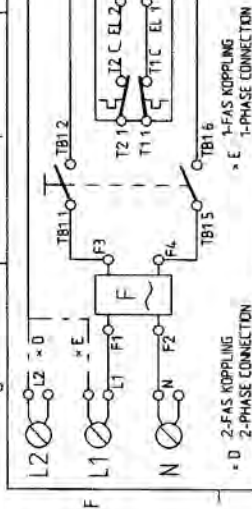

* F 10A 1-FASS ANSLUTNING
 EXCLUDED WHEN 1-PHASE 10A CONNECTION



KOPPLING UTAN 1/0-BRYTARE
 CONNECTION WITHOUT MAIN SWITCH

KOPPLING OHNE 1/0-SCHALTER

RESISTANCE VALUES AT 20°C/68°F
 VALUES WITHIN 10% IS NORMAL

AVLOPPSPUMP 230V 50Hz: 14.4 ohm
 230V 60Hz: 94.5 ohm
 120V 60Hz: 25.5 ohm

ABLAUFFÜRPE

BELYSN BRYTARE

BELEKTUNGSCHALTER

INNERBELYSNING 230V, 230 ohm
 BELEKTUNGSCHALTER 120V, 51 ohm

BE: INTERNAL ILLUMINATION

CP: MAIN PUMP 230V 50Hz: MAIN 57 AUX 83ohm
 230V 60Hz: MAIN 52 AUX 72ohm
 120V 60Hz: MAIN 10.5 AUX 14.5ohm

KOMBI-DISPENSER

KD: COMBI-DISPENSER 230V, 13 kohm
 120V, 0.31 kohm

DOSSERS

VÄRME ELEMENT 230V 2500W: 21 ohm
 HEATING ELEMENT 230V 1800W: 29 ohm
 HEZELEMENT 120V 1400W: 10 ohm

FLTER

F: FILTER 680 kohm (1-2, 3-4)

INLÖPSENTIL 230V: 3.7 kohm
 ENLÄUPVENTIL 120V: 0.93 kohm

FLAKT

F: FAN 230V: 0.73 kohm
 120V: 0.26 kohm

GEBLÄSE

LUCKBRYTARE

LB: DOOR SWITCH

TURSCHALTER

LUCKA

LU: DOOR

TUR

INKLUDERAD I VISSA MASKINER
 INCLUDED IN SOME MACHINES
 IN BEWISSEN GERÄTEN ENGESCHLOSSEN

N: NIVÅBRYTARE
 LEVEL SWITCH 2.4 kohm

NVEKAUSCHALTER

NV: WATERMISTOR

NTE: LEVEL THERMISTOR

NVEAU FÜHLER

P: PROGRAMTYREMET
 CONTROL UNIT

RELA

R: RELAY 230V ECHOFF: 2.0 kohm
 230V EBERLE: 0.59 kohm
 120V ECHOFF: 0.40 kohm

SG: SALTAVARE

SG: SALT FÜHLER

T: TERMOSTAT

T: THERMOSTAT

T: THERMOSTAT

TB: TRYCKBRYTARE
 PUSH BUTTON SWITCH

TTE: TEMP. THERMISTOR 26 kohm

TTE: TEMP. FÜHLER

VAK: VAK MOTOR 15 - 3.0 kohm

VAKSHÖTDR

VATMEDELSGVARE

VMS: RINSE AG SENSOR

KLARSPILMIFELFÜHLER

ÖVERFLYVADSBRYTARE

ÖVERFLÖVADSWITCH

ÖB: ÖBERFÜLLSICHERUNGSSCHALTER

05	Resistansvärden inf.	ML 97 42							
04	Koppl. innerbelysn. mod.	ML 97 36							
03	Koppl. xF: 1-fas 10A inf.	ML 95 48							
02	Ny koppl. avh m säkerh.	ML 95 13							
01	Koppl. utan 1/0-bryt.	inf ML 95 06							
01	ml ventfil avh. m. säk.	inf ML 95 06							
	Rev ind	Revision	Appd	Year	Week				

Article No.	80 584 83-05
Name of item	KOPPLINGSSCHEMA DW95.3/4/5/FI
Qty	1
Material,dimensions,type,etc.	

80 584 81
 05
 Replaced by
 8058481-04

Date
2000-06**SERVICE INFORMATION**Page
18

Product: DW95

Date: 98-03-12

TOPIC: DOOR SPRINGS

There are three different sets of door springs, as defined below:

Part Number	Machine	Weight Capacity	Color Coding
80 584 91-77	For all standard machines	9 lbs.	none
80 602 32-77	For integrated and fully-integrated machines	12 lbs.	yellow
80 713 23-77	Heavy-duty for wooden panels, available as accessory part	22 lbs.	red



Color code

Product: DW95

Date: 98-03-13

TOPIC: WATER LEVEL

Switch level transferred to measuring points on the coil arm bearing.

Timer-controlled machines

Water flow inlet valve = 3.8 +/- 5% ltr / min

Intake time = 60 seconds

- Max. tol. 3.8 +5% = 3.9 ltr +3 mm
- Max. tol. 3.8 +/- 5% = 3.9 ltr +2 mm
- Max. tol. 3.8 -5% = 3.9 ltr +1 mm

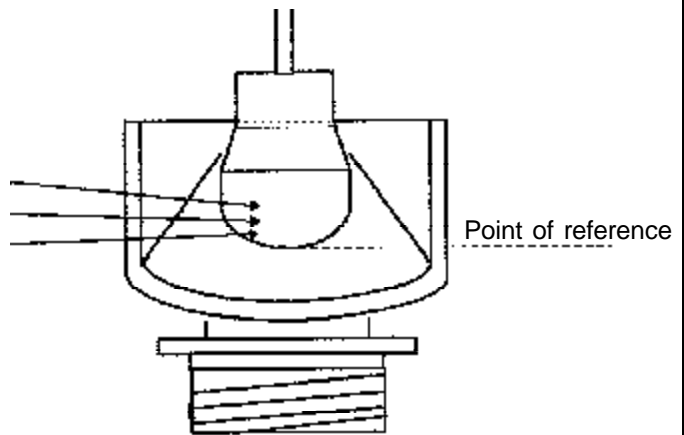

Electronic machines

Water flow inlet valve = 3.8 +/- 5% ltr / min

Intake time = 57 seconds

- Max. tol. 3.8 +5% = 3.7 ltr +1 mm
- Max. tol. 3.8 +/- 5% = 3.51 ltr +0 mm
- Max. tol. 3.8 -5% = 3.3 ltr -1 mm

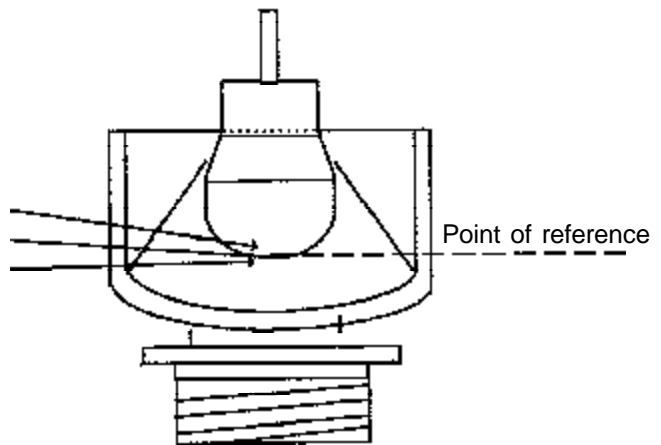

Note: Start with dry bottom well, which gives a 2mm lower level.

Date
2000-06**SERVICE INFORMATION**Page
20

Product: DW95

Date: 98-03-13

TOPIC: GUIDE PIN FOR DOOR LOCK

Occasionally, the guide pin for the door lock may freeze or become stuck, causing the machine not to stop when the door is opened. To prevent this, you can lubricate the guide pin with petroleum jelly.

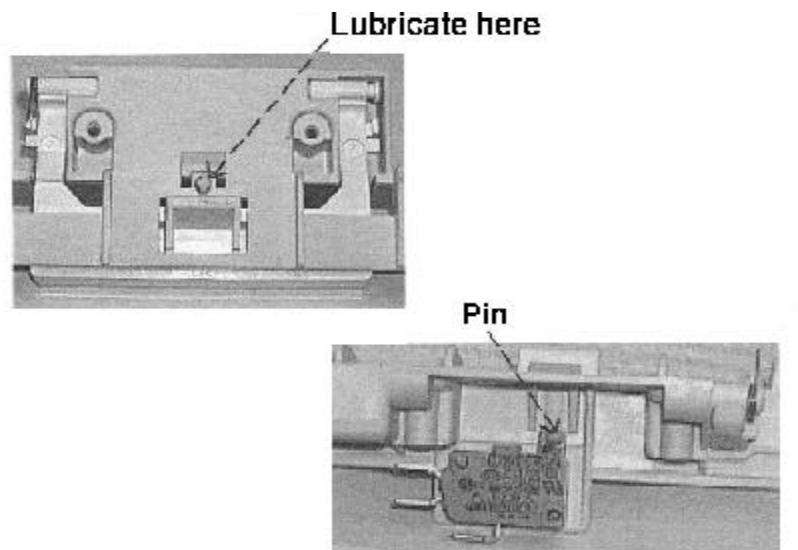

Date 2000-06	SERVICE INFORMATION	Page 21
------------------------	----------------------------	-------------------

Product: DW95

Date: 98-03-13

TOPIC: CONTROL UNIT FAILURE ANALYSIS

To prevent repeated exchanges of control units due to failures in auxiliary components (circulation pumps, inlet valves, etc.), a simple check on the control unit should be done to determine what cause the failure.

If any of the control unit components listed below or the conductive pattern (copper foil on the soldering side) near these components are damaged, most likely the external component caused the failure and should be ohm-measured. In the case of short-circuits, the components should be exchanged along with the control unit.

External Component	Associated Output Components
Heater	K1, PF2
Drain pump	K2, P1 5
Circulation pump	K3, P1 3
Inlet valve 1	Q13, R36, R52, D22, D24, P1 7
Inlet valve 2	Q6, R43, R55, D26, D27, P1 8
Combi-dispenser	Q12, R50, R58, D21, D23, P2 3
Fan and wax motor	Q16, R46, R56, D18, D19, P3 3
Interior light	P4 3 (after 9740, the lamp is not connected to the control unit.)

K=Relay
Q=Triac
R=Resistor
D=Diode
P=Connector

Note: Once the wax motor has dried out, it is not possible to measure for faults. Remove the wax motor and check for burn marks. For complete certainty, replace the wax motor.

Product: DW95

Date: 95-10

TOPIC: REMAINING TIME INDICATION

Dishwashers with an LED window show how much time remains for the program to run. This is calculated on the assumption that the incoming water is at a temperature of 141°F (60°C).

If the machine is connected to a cold water supply, the time display for the remaining time will be incorrect the first time each program is run. On subsequent runs of the respective programs, the machine will calculate the time based on how long the program took on the previous run.

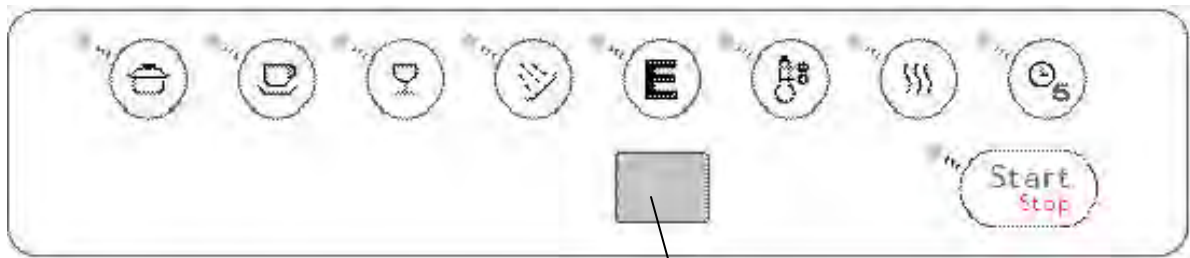

Remaining time displays in
the LED window.