

# INDEX

## D1996FI, SS, and HNDL DISHWASHER (DW95FI)

● PROGRAMS	2
● ELECTRICAL FUNCTIONS	5
● PART NUMBER SUFFIX DEFINITIONS	7
● SPARE PARTS LIST	
.. 1996FI Casing and related parts	8
.. 1996SS & HNDL Casing and related parts	10
.. Container and related parts	12
.. 1996FI Door	14
.. 1996SS & HNDL Door	16
.. 1996FI Control Panel	18
.. 1996SS Control Panel	20
.. 1996HNDL Control Panel	22
.. Dishwashing system	24
.. Interior light	26
● WIRING DIAGRAM	28
● TIMER DIAGRAM	29
● SERVICE INFORMATION	
.. Air duct nozzle	30
.. Door springs	31
.. Water level	32
.. Door lock	33
.. Control unit failure analysis	34

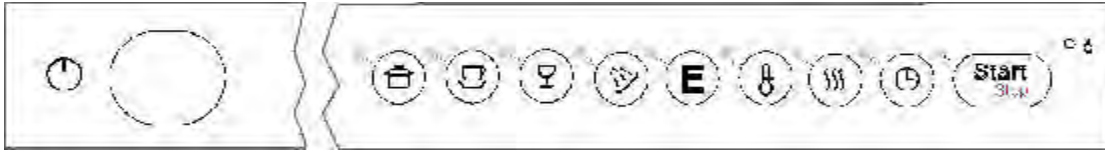

## PROGRAMS

PROGRAM	DEFINITION
<b>Pots and pans/Sani</b>	Two prewashes, main wash, three rinses* and drying.
<b>Normal</b>	Two prewashes, main wash, two rinses* and drying.
<b>Quick</b>	Short prewash, main wash, two rinses, heated drying.
<b>Rinse &amp; Hold</b>	One rinse. If Heat fan dry is selected, the heating element will activate. Rinse: 131°F (55°C). Drying: 158°F (70°C)

\* The Pots and Pans/Sani and Normal programs can be programmed for an extra rinse (see page 3). In that case, the temperatures for the next-to-last rinse would be the household water temperature and the final rinse would be the last rinse temperature indicated in the table below.

## OPTIONS

<b>Economy</b>	Lowers the water temperature in the main wash to 122°F (50°C) and extends the wash time in the main wash by 15 minutes.
<b>Temp selection</b>	Lets you select high or low water temperatures for the wash programs (except Rinse). (See the table below.) The indicator light glows when it's on the High setting and remains off when set on Low.
<b>Heat Fan Dry</b>	Pressing this touchpad activates the heating element along with the turbo fan for 12 minutes after the final rinse. (158° F/70° C)
<b>Delay</b>	Lets you delay running the dishwasher for five hours. After making your selections, press the Delayed Start touchpad then press Start and close the door. The machine will start in 5 hours.
<b>Start/Stop</b>	Press this touchpad to Start or Stop the machine. To interrupt a program, hold this touchpad down for three seconds.

## WASH PROGRAM TEMPERATURES

Wash Program	Temp	1st Prewash	2nd Prewash	Main Wash	1st Rinse	2nd Rinse	3rd Rinse
Pots & Pans/Sani	<b>Low</b>	113°F (45°C)	House	131°F (55°C)	House	House	131°F (55°C)
	<b>High</b>	113°F (45°C)	House	158°F (70°C)	House	House	149°F (65°C)
Normal	<b>Low</b>	86°F (30°C)	House	131°F (55°C)	House	131°F (55°C)	n/a
	<b>High</b>	86°F (°30C)	House	149°F (65°C)	House	149°F (65°C)	n/a
Quick	<b>Low</b>	House	n/a	113°F (45°C)	House	113°F (45°C)	n/a
	<b>High</b>	House	n/a	131°F (55°C)	House	131°F (55°C)	n/a

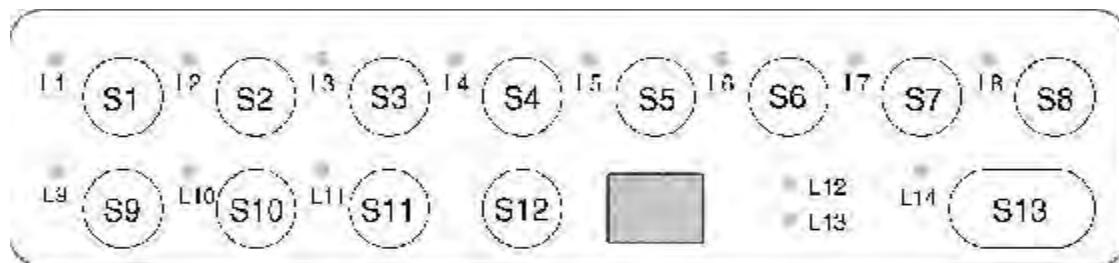

S = Pushbutton switch

L = Indicator light

### EXTENDING FAN COOLING TIME

To extend the fan cooling time, **press S1 five times then press** one of the following:

- S5** for 30 extra minutes
- S4** for normal fan cooling time

### SETTING AN EXTRA RINSE

To add an extra rinse to the Pots and Pans and Normal wash programs, **press S2 five times then press** one of the following:

- S5** for an extra rinse
- S4** for the normal number of rinses

### SETTING CHILD-SAFE START FUNCTION

The start function can be reprogrammed so that the button must be pressed in for 3 seconds to start the programs. To do so, **press S4 five times then press** one of the following:

- S5** to get a prolonged start function or
- S4** to get a normal start function

### SETTING PUMP-OUT TIME

If it's necessary to reprogram the pump-out time, you can do so by **pressing S3 five times then pressing** one of the following:

<b>Press:</b>	<b>to get an outlet time of:</b>
<b>S3</b>	20 seconds
<b>S4</b>	25 seconds (factory setting)
<b>S5</b>	35 seconds
<b>S6</b>	45 seconds
<b>S7</b>	85 seconds

### SETTING INLET TIME

You can reprogram the inlet time on level controlled and time controlled inlets. To do this, **press S5 five times then press** one of the following:

<b>Press:</b>	<b>to get an inlet time of:</b>
<b>S3</b>	45 seconds (factory setting)
<b>S4</b>	56 seconds
<b>S5</b>	68 seconds
<b>S6</b>	90 seconds
<b>S7</b>	113 seconds
<b>S8</b>	180 seconds

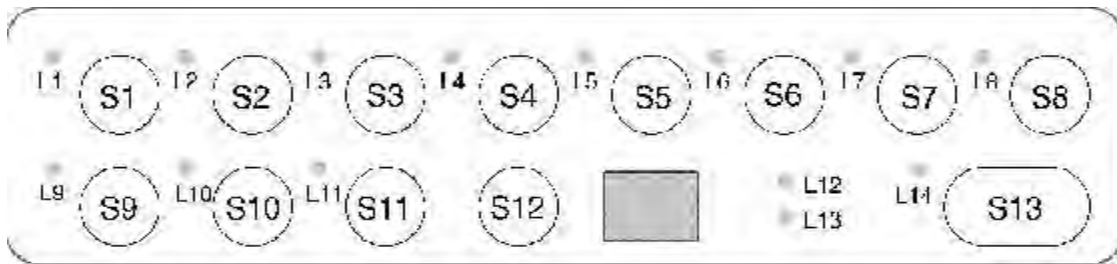

S = Pushbutton switch

L = Indicator light

## FAULT INDICATIONS

Blinking lights indicate a machine fault.

<b>Blinking Lights</b>	<b>Problem</b>
L3 and L7	Heating element
L1-L8	Overfill
L4 and L5	Thermistor fault (heater control)
L1-L4	Water inlet

## FAULT-TRACING PROGRAM

The functions of the electrical components can be tested by **pressing S6 five times then pressing** one of the following:

- S2** for inlet valve 2
- S3** for inlet valve 1
- S4** for combi-dispenser
- S5** for heating element
- S6** for the circulation pump
- S7** for the outlet pump
- S8** for fan motor and wax motor

Stop the fault-tracing program by pressing one of the program buttons for 3 seconds.

## LINKS ON THE PROCESSOR BOARD (for program variations)

These diodes should be cut for proper U.S. installation:

- Link 953: D1796 processor board layout
- Link USA: USA processor board layout

**CONTROL PANEL (see page 15)**

The control panel contains a microprocessor for control of programs, circulation pump, inlet valves, etc. It also allows for custom settings of programs (see page 3).

**CIRCULATION PUMP/MOTOR (see page 17)**

The circulation pump/motor consists of a synchronous motor and pump, constructed in an integrated unit. A 16  $\mu$ F capacitor is fitted to the circulation motor/pump.

**OUTLET PUMP (see page 17)**

The outlet pump consists of a synchronous motor and pump, constructed in an integrated unit.

**INLET VALVE (see page 17)**

A single-unit type: A solenoid and valve seat.

**HEATING ELEMENT (see page 11)**

1400 Watt

**THERMISTOR (see page 11)**

The thermistor controls the water temperature within  $\pm 1^{\circ}\text{C}$  ( $2.5^{\circ}\text{F}$ ) to give the required temperature. The heater will be disconnected if the thermistor is short-circuited or loosened from the circuit board and the fault code "F3" displays in the LED window. The normal resistance of the thermistor is between 25 and 15K ohm at  $68^{\circ}\text{F}$  ( $20^{\circ}\text{C}$ ) or  $86^{\circ}\text{F}$  ( $30^{\circ}\text{C}$ ) alternately.

**OVERHEAT PROTECTION (see page 11)**

The thermostat has a switch-off function at  $190^{\circ}\text{F}$  ( $88^{\circ}\text{C}$ ) that prevents the heating element from staying on if the control unit or the timer should fail.

**DOOR SWITCH (see page 17)**

A microswitch senses that the door has been opened. This interrupts the program and cuts the power to all control components (motor, valves, etc.).

**LEVEL SWITCH (PRESSURE SWITCH) (see page 11)**

This switch provides protection against overfilling by interrupting the power to the inlet valve and starting the outlet pump. If the water level has not dropped within 30 seconds or if overfill has occurred twice during the same program, the program will be terminated and a fault code displays. The overfill protection operates during all programs, including fault-tracing, even if the microprocessor is faulty.

**OVERFILL SWITCH (see page 11)**

A float in the base pan influences a microswitch that disconnects the inlet valve and starts the outlet pump.

**COMBI-DISPENSER (see page 13)**

The combi-dispenser dispenses both detergent and rinse aid. The dispenser has an adjustable volume chamber for setting the desired amount of rinse aid.

**TURBO FAN (see page 13)**

The turbo fan evacuates the moist air from the machine during the drying phase of the program. The fan system consists of a fan motor that runs a two-part impeller. Dry, cool air is pulled in from the door into one of the impeller halves. A wax motor opens a damper and the moist air is pulled into the other part of the impeller. The dry, cool air and warm, moist air mix and condense in the condensation chamber. The condensed moisture then drains through the channel to the lower sump area. Dry air is then vented out through a channel below the outer door.

**ELECTRICAL SUPPLY**

The machines are wired for connection to a single-phase, 120V, 15A supply, with a heater power of 1400W, giving a total power requirement of 1600W.

**VALUES FOR WIRING DIAGRAMS**

Resistance values at 68° F (+/-5°F), 20° C (+/-3°C)

(Values within +/- 10% is normal.)

AP	Drain pump	120V, 60 Hz, 25.5 ohm
BB	Illumination switch	
BE	Internal Illumination	120V, 51 ohm
CP	Main pump	120 V, 60 Hz, Main = 10.5 ohm, Aux = 14.5 ohm
KD	Combi-dispenser	120 V, 0.31 ohm
EL	Heating element	120 V, 1400 W, 10 ohm
F	Filter	680 K ohm (1-2,3-4)
IV	Inlet valve	120 V, 9.93K ohm
FL	Fan	120 V, 0.25K ohm
LB	Door switch	
LU	Door	
N	Level switch	
P	Control unit	
T	Thermostat	19–25 K ohm
TB	Pushbutton switch	
TTE	Temp. thermistor	18–25 K ohm
WAX	Wax motor	1.5–3.0 K ohm
VMG	Rinse ag sensor	
OB	Overflow switch	

The lists below define the meanings of the dashed numbers or letters following a part number:

### Colors:

- 0 White
- 29 Black, bright
- 33 Black
- 36 Dark grey
- 49 Helios grey
- 69 black, metallic
- 77 grey
- 81 metallic
- 95 Stainless Steel

**Note:** Not all colors are available for all parts.

### Doors

- M for units with fan
- P for integrated units
- R for decor frames, long deviation
- S for decor frames, short deviation
- T for decor frames with adjustable lower part



Model D1996FI, SS, and HNDL  
(DW 95FI)

Date 2000-06	<b>1996FI CASING AND RELATED PARTS</b>	Page <b>8</b>
-----------------	--	------------------

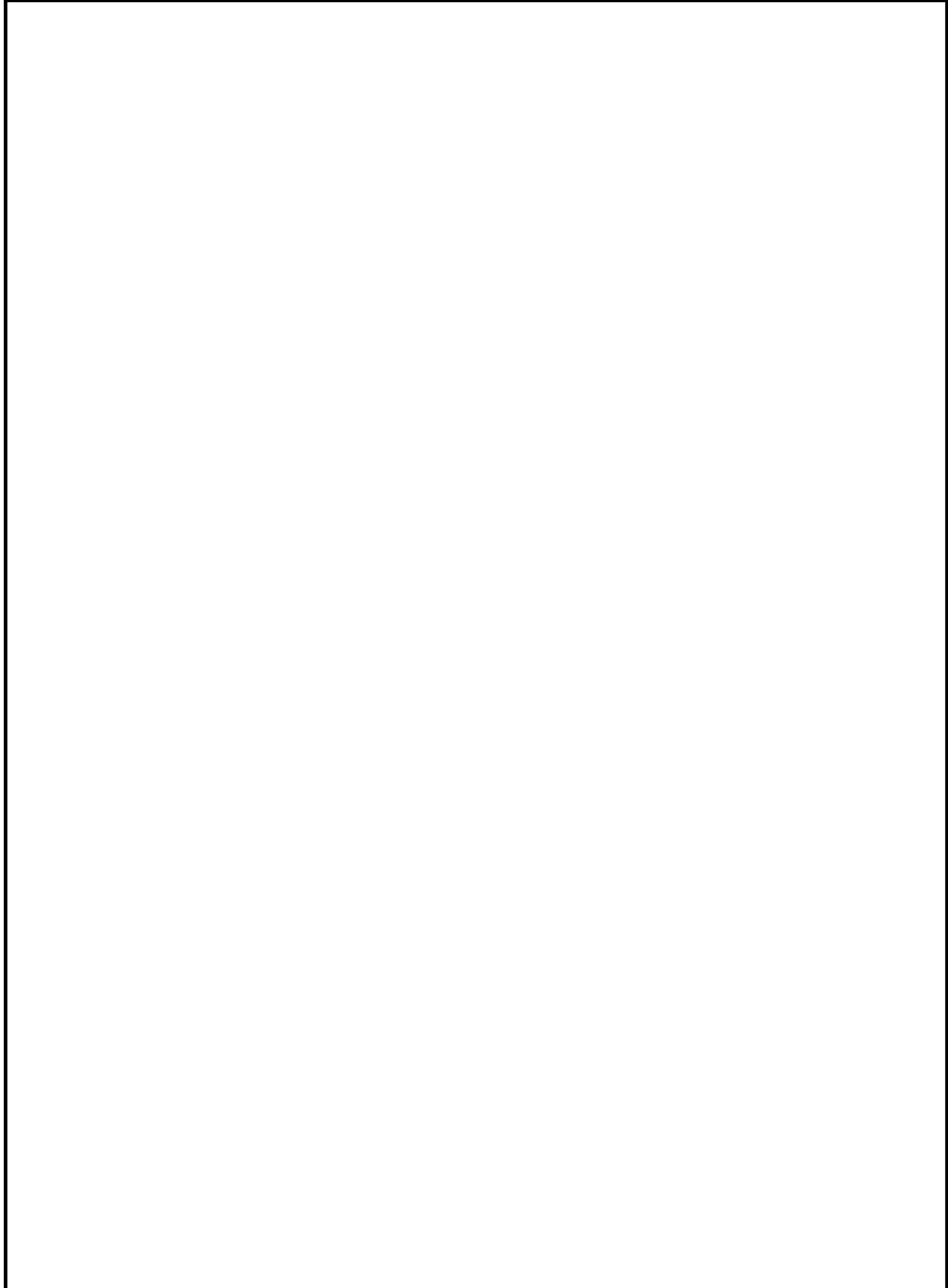





Model D1996FI, SS, and HNDL  
(DW 95FI)

Date		<b>1996FI CASING AND RELATED PARTS</b>		Page
2000-06				9
Fig.	Qty	Part No.	Description	Notes
1	1	80 583 53	Sound insulation	
2	1	80 600 41	Sound insulation profile	
3	1	80 575 26	Guard plate	
	4	89 003 52	Screw	RTS ST 4.2x13
4	1	80 600 87	Felt, kick plate	
5	1	80 575 28-	Kick plate, low	-0, -29
	1	80 575 29-	Kick plate, high	-0, -29
	2	89 009 44-	Screw, kick plate	-0, -29
9	1	80 584 86	Drip protection for guard plate	
10	2	80 575 49	Bracket, kick plate	
11	2	80 575 50	Spring, kick plate	
	2	89 003 27	Screw	RTS ST 4.2x13 FZB T20



Date 2000-06	<b>1996SS and HNDL CASING AND RELATED PARTS</b>	Page 10
-----------------	---	------------

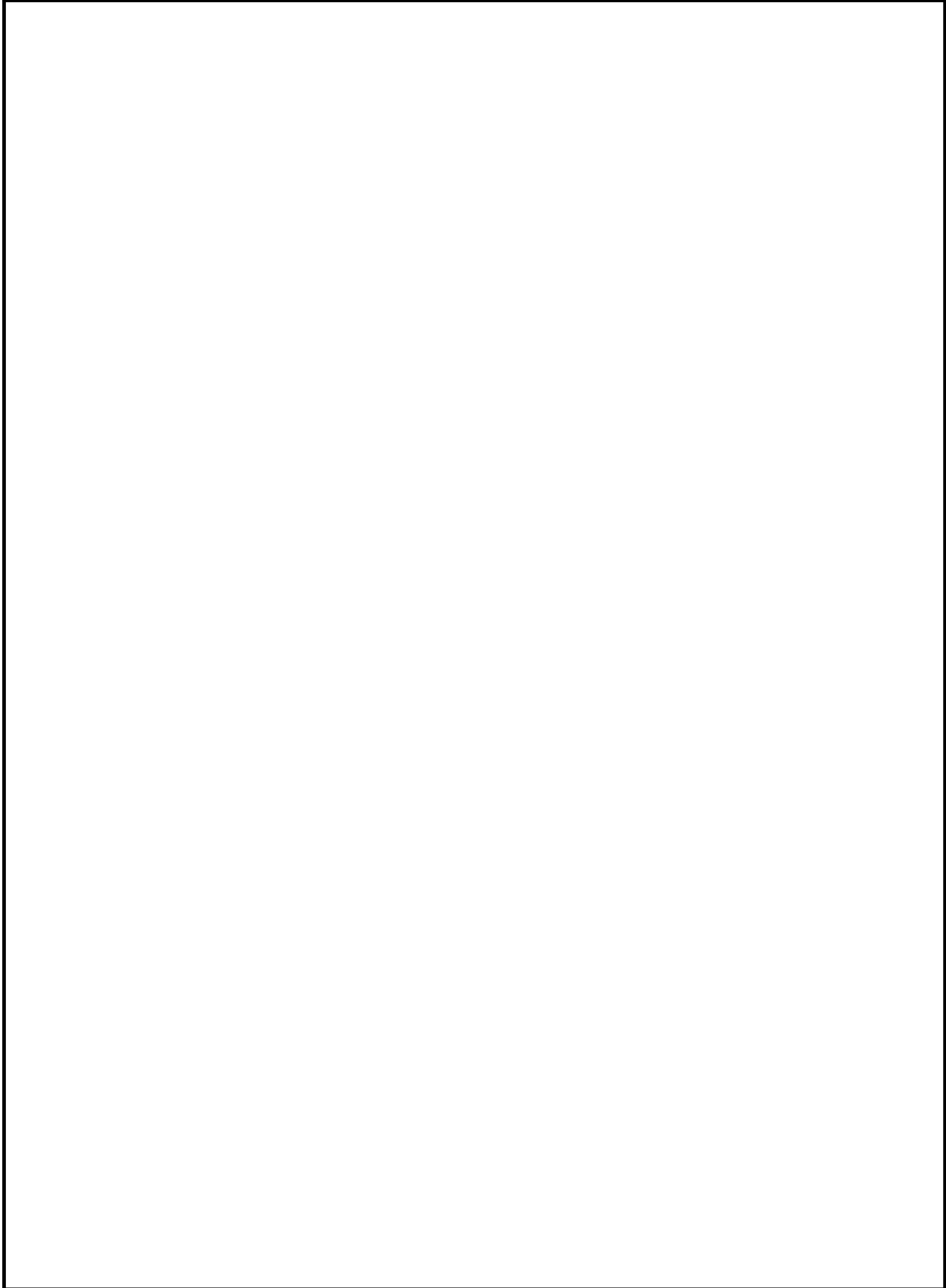



Model D1996FI, SS, and HNDL  
(DW 95FI)

Date		1996SS AND HNDL CASING AND RELATED PARTS		Page
2000-06				11
Fig.	Qty	Part No.	Description	Notes
1	1	80 583 53	Sound insulation	
2	1	80 600 41	Sound insulation profile	
3	1	80 575 26	Guard plate	
	4	89 003 52	Screw	RTS ST 4.2x13
4	1	80 707 43	Felt, kick plate	
5	1	80 597 58-	Kick plate, low	-0, -29
	2	89 009 44-	Screw, kick plate	-0, -29
6	1	80 706 15	Sealing strip	
7	1	80 571 00-	Lower cover	-S-0, -S-29, -95
	2	89 003 52	Screw	RTS ST 4.2x13
	4	80 097 69-	Plug for decor frame	-0, -33
8	1	80 706 12	Sound insulation	
9	1	80 584 86	Drip protection for guard plate	
10	2	80 575 49	Bracket, kick plate	
11	2	80 575 50	Spring, kick plate	
	2	89 003 27	Screw	RTS ST 4.2x13 FZB T20



Date 2000-06	<b>CONTAINER AND RELATED PARTS</b>	Page 12
-----------------	------------------------------------	------------

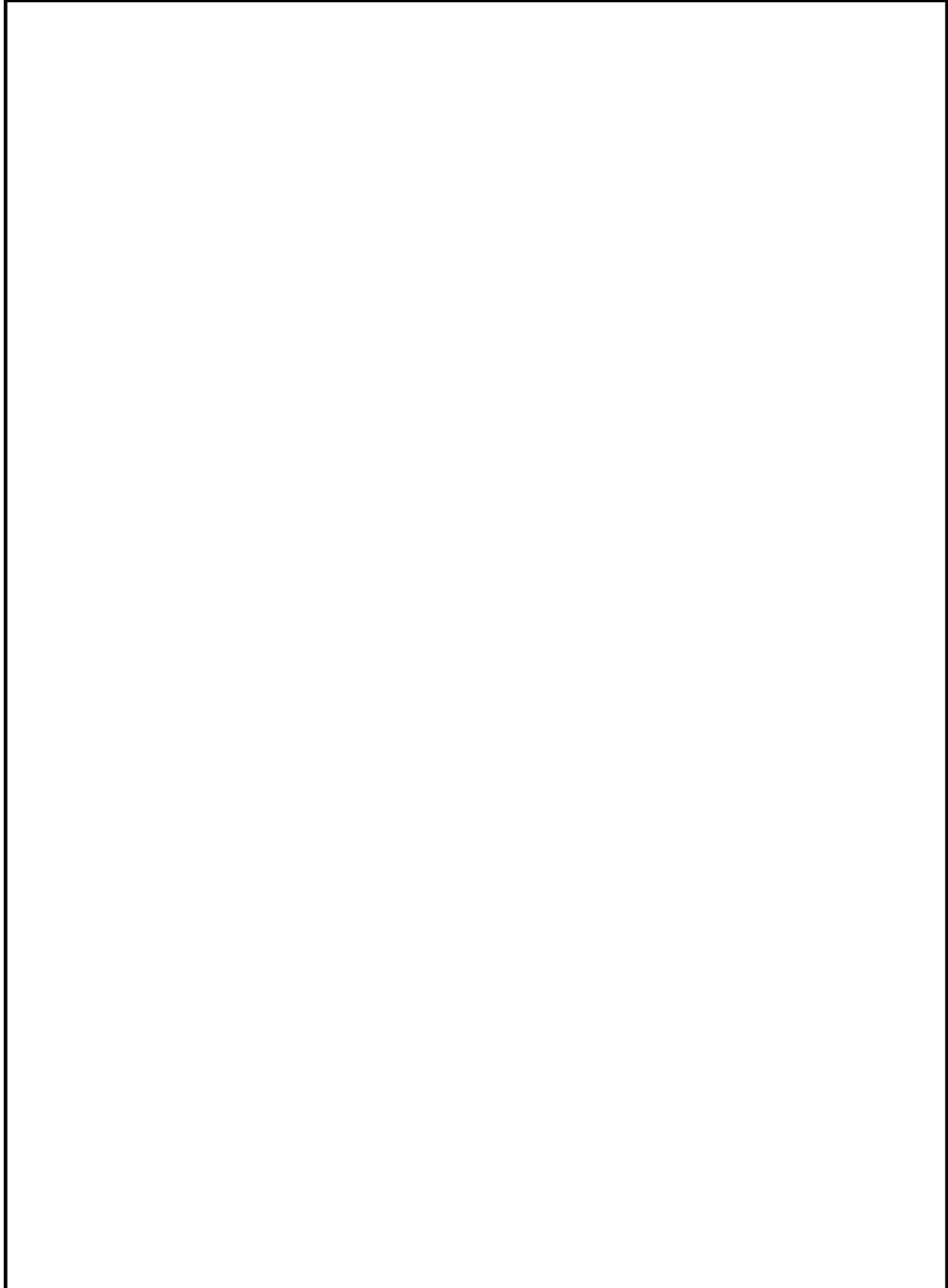

Date		CONTAINER AND RELATED PARTS		Page
2000-06				13
Fig.	Qty	Part No.	Description	Notes
2	1	80 600 65	Sealing strip, left	
	1	80 600 66	Sealing strip, right	
	2	80 600 38	Insulation, bottom outer	
3	1	80 574 89	Tub seal	
4	2	80 579 78-	Ball catch	-77
5	2	80 586 38-	Ball bearing holder, guide rail	-77
6	8	80 579 77	Ball bearings	
7	2	80 579 79-	Basket stop	-77
8	2	80 570 52	Guide rail	
9	1	80 600 33	Sound insulation	
10	4	89 011 10	Screw + O-ring	A2-M6x12 T30
11	1	80 570 77	Heating element	1400 W 120 V
	1	80 602 58	Cable holder	For heating
	2	80 023 70	Protection collar, heating	
12	1	80 584 95		
13	2	80 583 52	Sound insulation	
14	1	80 701 42	Cable holder	
15	1	80 025 79	Thermostat	Overheat protection
16	1	80 597 61-	Strip side, left	-0, -29, -95, for D1996SS & HNDL
	1	80 59762-	Strip side, right	-0, -29, -95, for D1996SS & HNDL
	4	89 006 46	Screw	A4RTS 4.2x13 T20
	2	89 003 52	Screw	RTS ST 4.2x13
17	2	80 706 14	Sealing strip	for D1996SS & HNDL
18	1	80 575 23	Base pan	
	2	89 011 04	Screw	A2-MRT-TT 4x8 T20
19	2	80 584 91-	Door springs compl.	-77, for D1996SS & D1996HNDL
	2	80 602 32	Door springs compl., integrated	-77, D1996FI
	2	80 713 23-	Door springs compl., integrated	-77, heavy-duty for D1996FI (optional)
20	1	80 704 95	Mount, inlet valve	
	2	89 003 27	Screw	RTS ST 4.2 x 13 FZB T20
21	1	80 602 55	Mount, electrical connection	
22	1	80 599 91	Cable holder	
23	1	80 069 48	Grommet	
24	1	80 585 58	RFI filter	
25	1	80 502 51	Terminal block	3-pole
	1	89 003 57	Screw, terminal block	RTS ST 4.2x25 FZB T20
	1	89 021 31	Screw, grounding terminal bl.	MRT-TT 4x6 FZB T20
	1	89 014 13	Washer	AZ 4.3 FZB
26	4	80 721 19	Reinforcement washer	
27	4	80 570 62	Leveling leg	M10x100, 8.8 FZB
28	4	89 011 56	Nut	M6M10 BH8 FZB
29	2	80 519 57	Slide foot, rear only	



Model D1996FI, SS, and HNDL  
(DW 95FI)

Date 2000-06	<b>D1996FI DOOR</b>	Page 14
-----------------	---------------------	------------

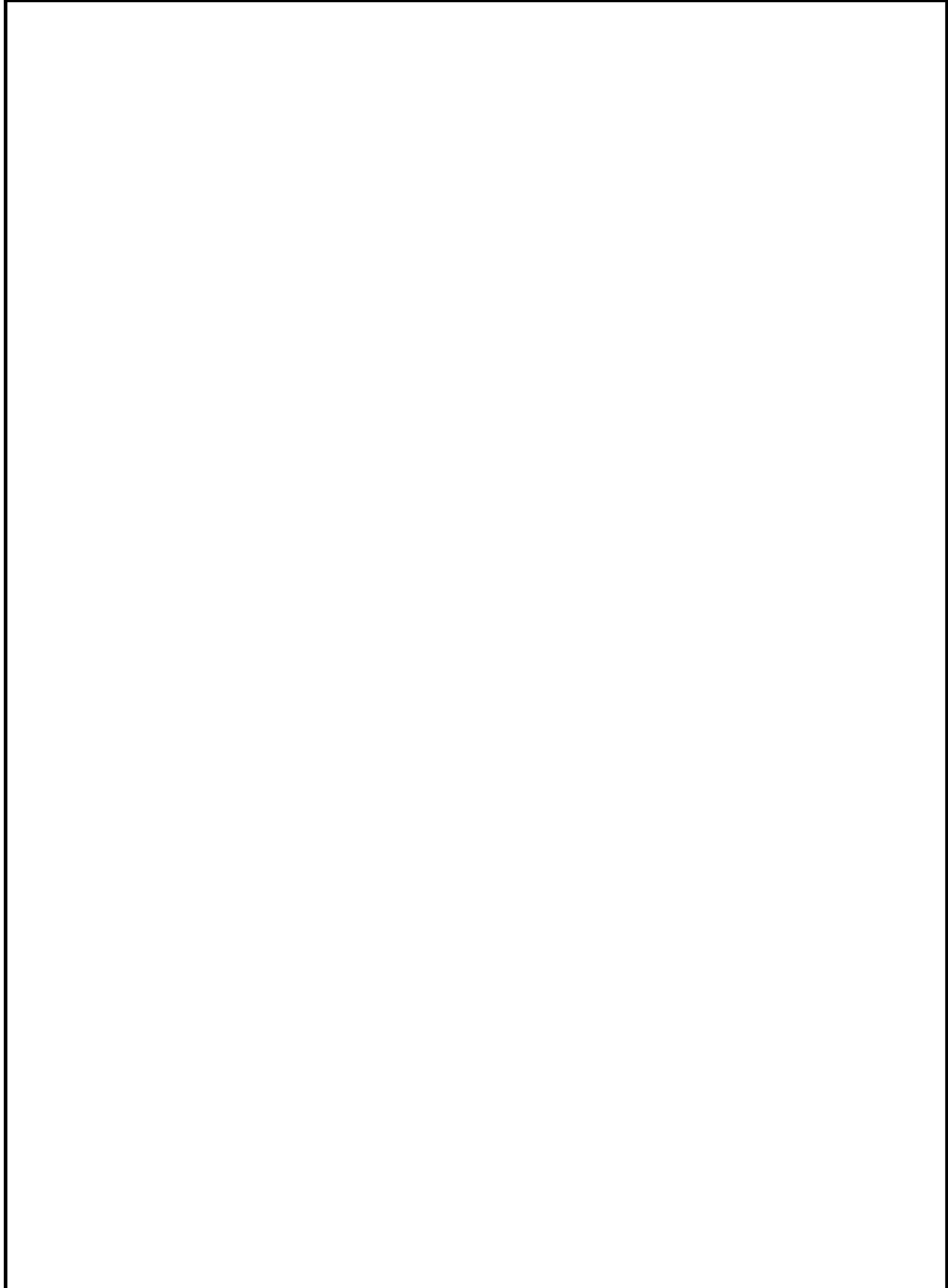

Date		D1996FI DOOR		Page
2000-06				15
Fig.	Qty	Part No.	Description	Notes
1	1	80 600 21	Fan, complete	
2	1	80 527 78	Wax motor	
3	1	80 585 01	O-ring	
4	1	80 579 63-	Air channel, turbo dry	-S
5	1	80 722 97	Nozzle for air channel	(See page 28)
6	1	80 722 98-	Strut for nozzle	-29
7	1	88 011 20	Inner door, compl.	
	4	89 021 20	Screw	A2-MKFT 5x10-TT FZB
8	1	80 579 64	Lock ring, fan casing	
9	1	80 584 84	Cover plate, fan	
	2	89 020 85	Screw, fan cover plate	A2-PTK 40x10 WN1452
10	1	80 706 79-	Combi-dispenser	-77
	6	89 020 87	Screw	PTK 40x14 WN1452 FZB
	1	80 719 17	Rinse aid cap	
	1	80 719 18	Combi-dispenser lid	Incl. seal and spring
11	1	80 575 25	Hinge, left	
	1	80 575 24	Hinge, right	
	2	80 575 30	Hinge screw	
	2	33500262	Nut, hinge bearing, locking	Locking 4 BH8 FZB
12	2	80 579 48	Slide washer, hinge bearing	
13	1	80 715 87	Holder, cable harness	
	1	89 021 31	Screw, cable harness holder	MRT-TT 4x6 FZB T20
14	1	80 602 54	Door seal, lower	L=555 mm
15	1	80 579 85	Brace stand	
	2	89 006 46	Screw, lower stay	A4 RTS 4.2x13 T20
18	1	80 579 86-	Outer door	-PT-0, PT-29
	6	89 006 46	Screw	A4 RTS 4.2x13 T20
	2	89 003 27	Screw, lower stay	RTS ST 4,2x13 FZB T20
	2	80 703 50-	Plug	-0, -33
19	1	80 702 94	Sound insulation, short	
20	1	80 703 63	Adjusting frame, complete	



Date 2000-06	<b>D1996SS AND HNDL DOOR</b>	Page <b>16</b>
-----------------	------------------------------	-------------------

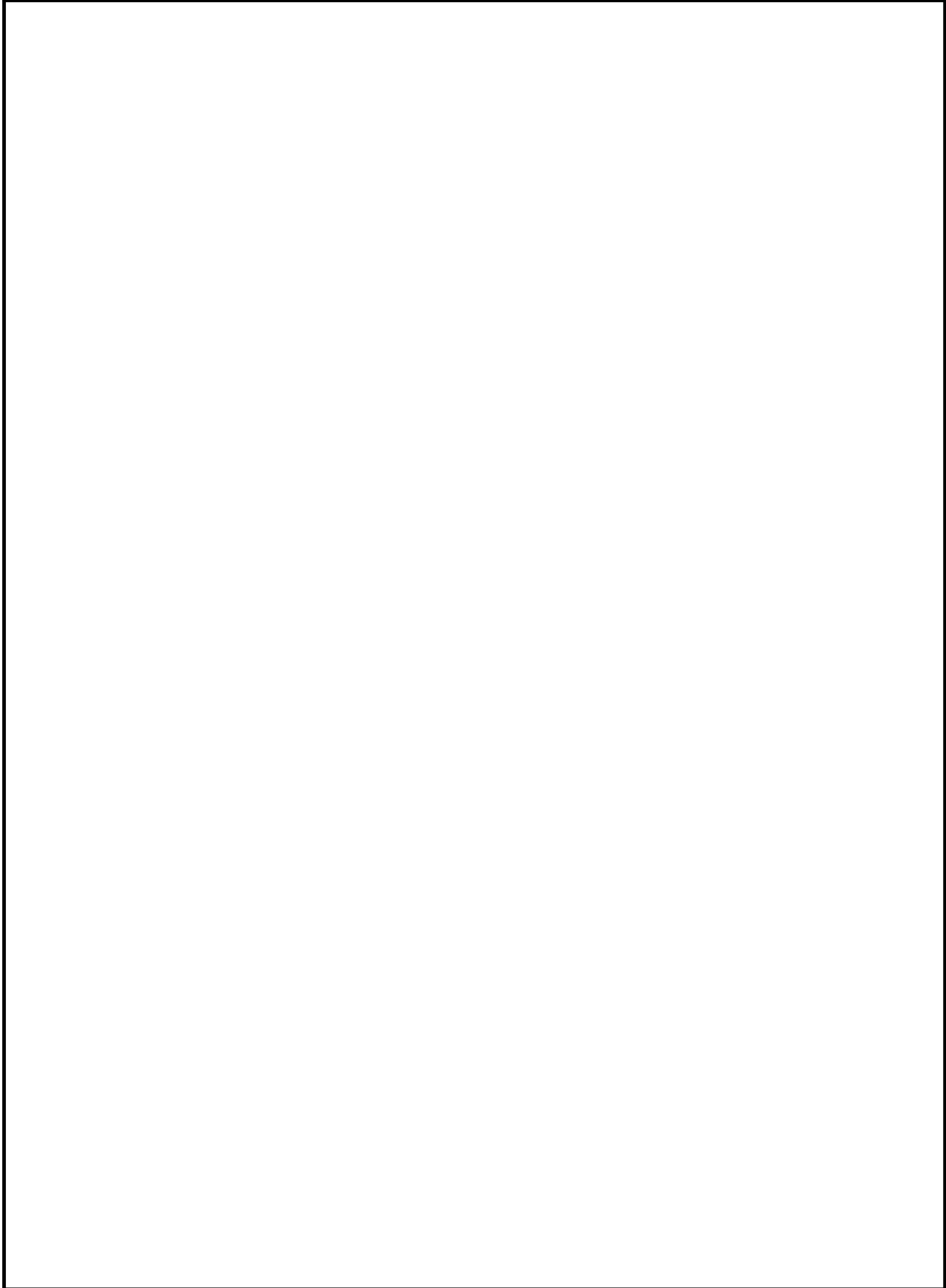



Date		D1996SS AND HNDL DOOR		Page
2000-06				17
Fig.	Qty	Part No.	Description	Notes
1	1	80 600 21	Fan, complete	
2	1	80 527 78	Wax motor	
3	1	80 585 01	O-ring	
4	1	80 579 63-	Air channel, turbo dry	-S
5	1	80 722 97	Nozzle for air channel	(See page 28)
6	1	80 722 98-	Strut for nozzle	-29
7	1	88 011 18	Inner door, compl.	
	4	89 021 20	Screw	A2-MKFT 5x10-TT FZB
8	1	80 579 64	Lock ring, fan casing	
9	1	80 584 84	Cover plate, fan	
	2	89 020 85	Screw, fan cover plate	A2-PTK 40x10 WN1452
10	1	80 706 79-	Combi-dispenser	-77
	6	89 020 87	Screw	PTK 40x14 WN1452 FZB
	1	80 719 17	Rinse aid cap	
	1	80 719 18	Combi-dispenser lid	Incl. seal and spring
11	1	80 575 25	Hinge, left	
	1	80 575 24	Hinge, right	
	2	80 575 30	Hinge screw	
	2	33500262	Nut, hinge bearing, locking	Locking 4 BH8 FZB
12	2	80 579 48	Slide washer, hinge bearing	
13	1	80 715 87	Holder, cable harness	
	1	89 021 31	Screw, cable harness holder	MRT-TT 4x6 FZB T20
14	1	80 602 54	Door seal lower	L=555 mm
15	1	80 579 85	Brace stand	
	2	89 006 46	Screw, lower stay	A4 RTS 4.2x13 T20
16	1	80 579 86-	Outer door	-PT-0, PT-29
	6	89 006 46	Screw	A4 RTS 4.2x13 T20
	2	89 003 27	Screw, lower stay	RTS ST 4,2x13 FZB T20
	2	80 561 17	Screw	-29
	6	80 097 69-	Plug	-0, -33
17	1	80 702 94	Sound insulation, short	



Date 2000-06	<b>1996FI CONTROL PANEL</b>	Page <b>18</b>
-----------------	-----------------------------	-------------------

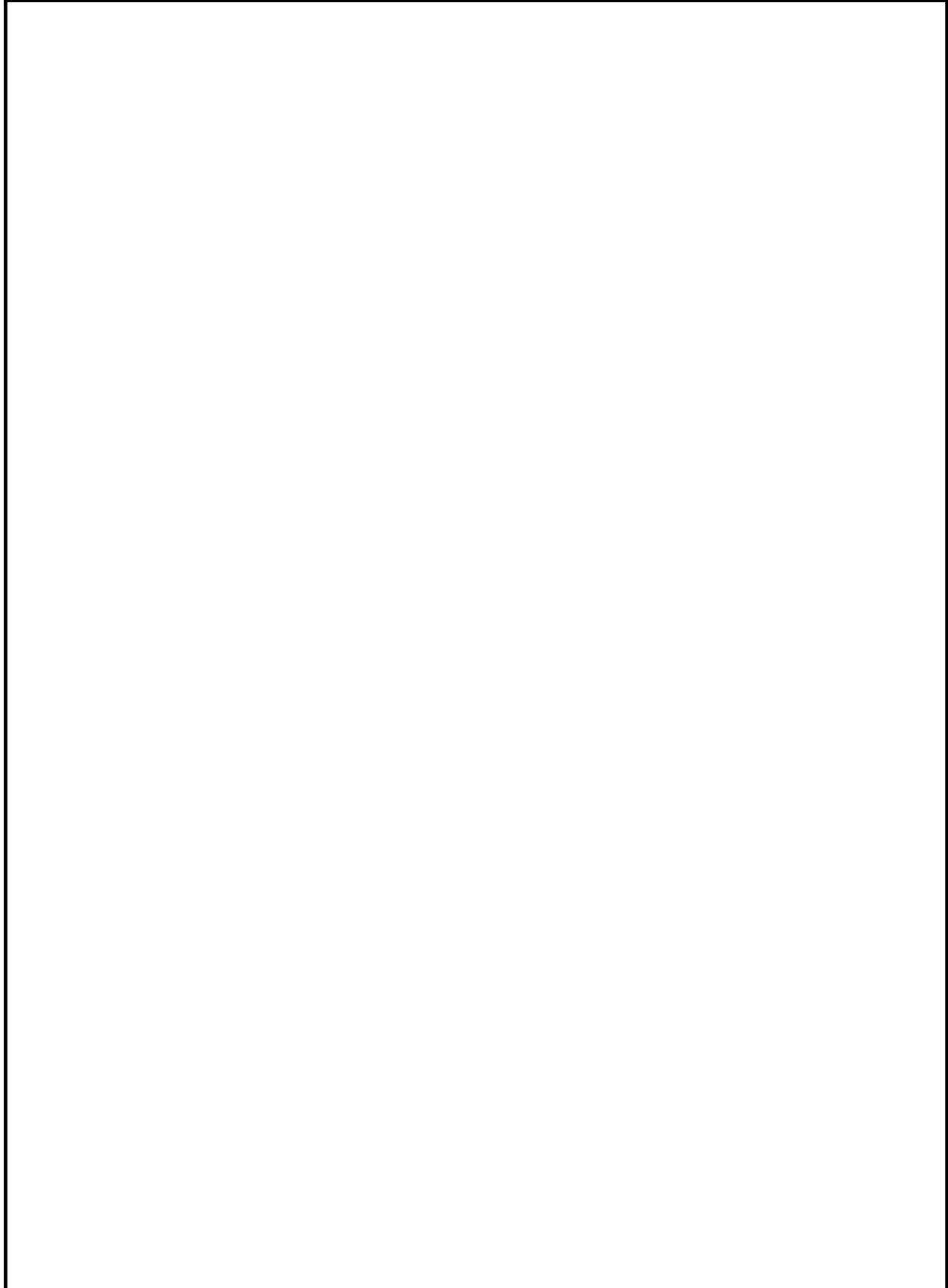



Model D1996FI, SS, and HNDL  
(DW 95FI)

Date		1996FI CONTROL PANEL		Page
2000-06				19
Fig.	Qty	Part No.	Description	Notes
1	1	80 708 83-	Decor insert	-0, Assembly instruction
2	1	80 706 50	Spring	
3	1	80 706 44-	Pushbotton	-0, -33, -81
4	1	80 706 43-	Main switch casing	-0, -33, -81
5	1	80 575 47	Main switch	
6	1	80 710 77	Hose	9x13x295
7	1	80 706 47	Lock casing	
8	1	80 706 45-	Masking	-77
9	1	80 706 48	Lock washer	
10	1	80 706 49	Lock catch	
	1	89 011 04	Screw	A2-MRT-TT 4x8 T20
11	1	80 710 49	Protective film	
12	1	88 012 03	Control unit	
	1	80 600 76	Contact cover	
	2	89 020 53	Screw	PTK 40x45/15 FZB
	2	89 020 87	Screw	PTK 40x14 WN1452 FZB
13	1	80 706 41	Handle	
	2	89 020 87	Screw	PTK 40x14 WN1452 FZB
14	1	80 729 40-	Decor insert	-81
15	1	80 706 40-	Panel	-0, -69, -81
	2	89 020 85	Screw	A2-PTK 40x10 WN1452
16	1	80 597 67	Thermistor	
17	1	80 734 64	Cableharness complete	
	1	80 730 96	Use and Care Guide	



Date 2000-06	<b>1996SS CONTROL PANEL</b>	Page 20
-----------------	-----------------------------	------------

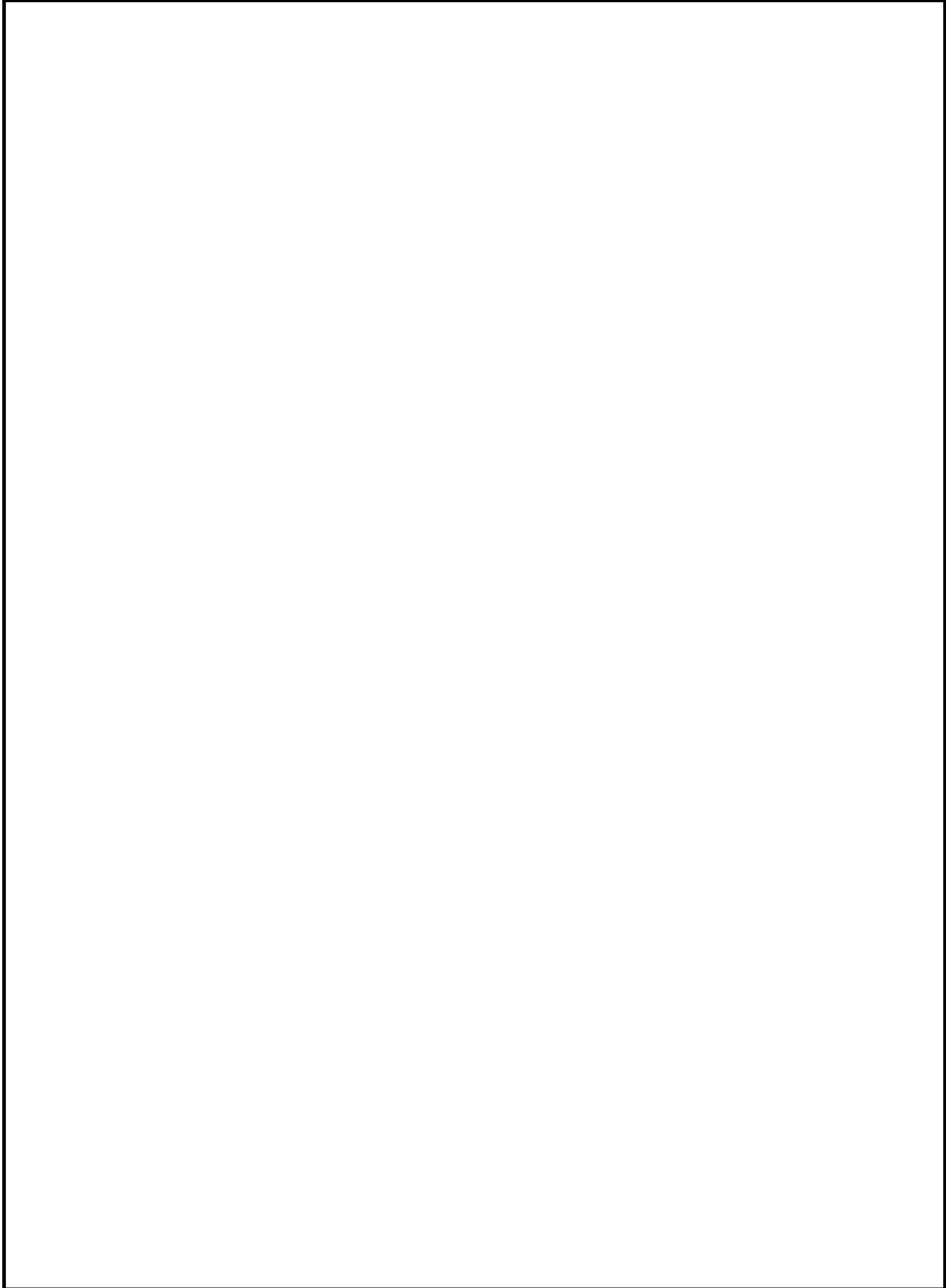



Model D1996FI, SS, and HNDL  
(DW 95FI)

Date		1996SS CONTROL PANEL		Page
2000-06				21
Fig.	Qty	Part No.	Description	Notes
1	1	80 708 82-	Decor insert	-0, -33, -95
2	1	80 706 50	Spring	
3	1	80 706 44-	Pushbotton	-0, -33, -81
4	1	80 706 43-	Main switch casing	-0, -33, -81
5	1	80 575 47	Main switch	
6	1	80 710 77	Hose	9x13x295
7	1	80 706 47	Lock casing	
8	1	80 706 45-	Masking	-77
9	1	80 706 48	Lock washer	
10	1	80 706 49	Lock catch	
	1	89 011 04	Screw	A2-MRT-TT 4x8 T20
11	1	80 710 49	Protective film	
12	1	88 012 03	Control unit	
	1	80 600 76	Contact cover	
	2	89 020 53	Screw	PTK 40x45/15 FZB
	2	89 020 87	Screw	PTK 40x14 WN1452 FZB
13	1	80 706 41	Handle	
	2	89 020 87	Screw	PTK 40x14 WN1452 FZB
14	1	80 729 40-	Decor insert	-81
15	1	80 706 40-	Panel	-0, -69, -81
	2	89 020 85	Screw	A2-PTK 40x10 WN1452
16	1	80 597 67	Thermistor	
17	1	80 734 64	Cableharness complete	
	1	80 730 96	Use and Care Guide	



Date 2000-06	<b>1996HNDL CONTROL PANEL</b>	Page 22
-----------------	-------------------------------	------------

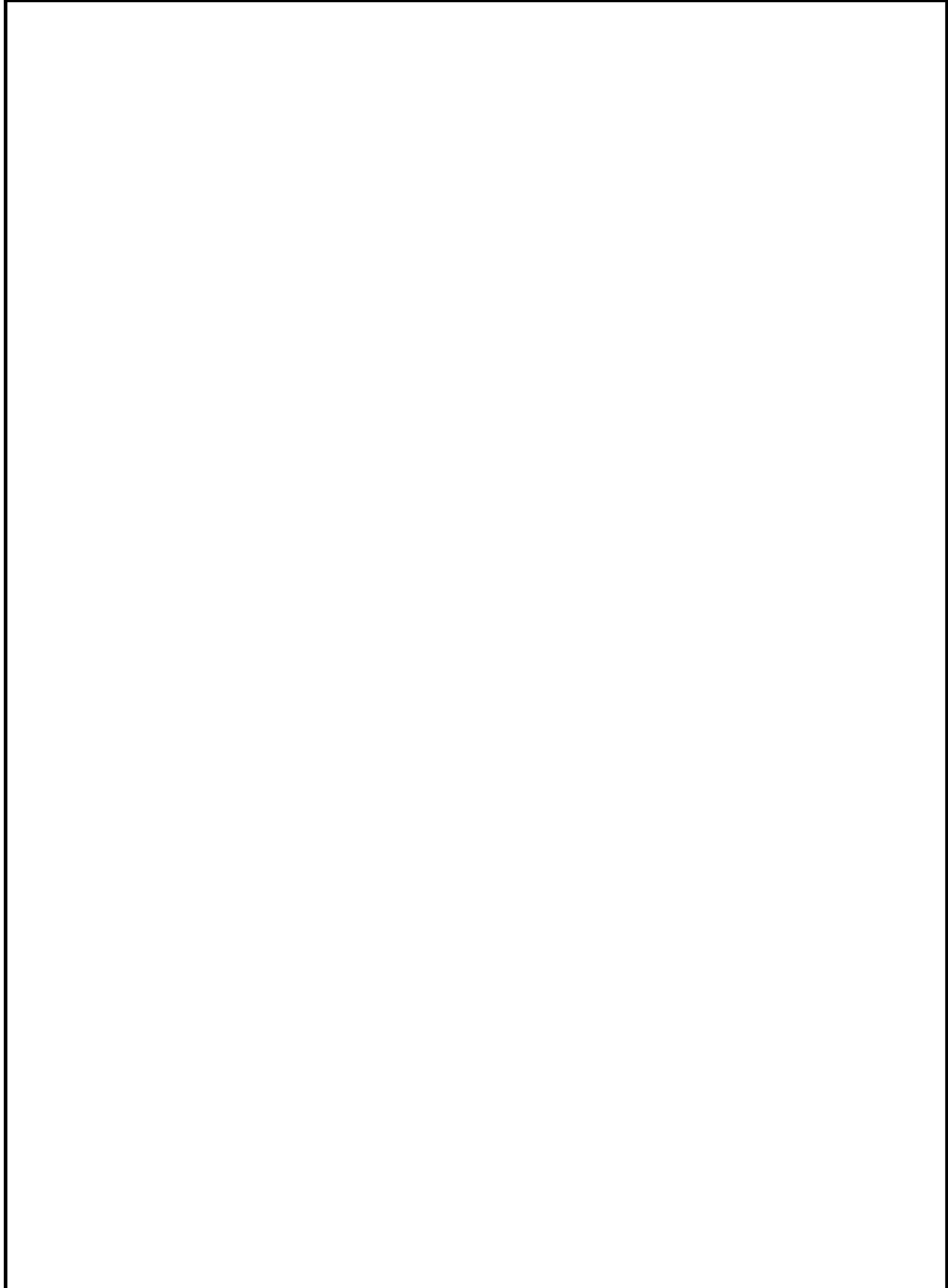



Model D1996FI, SS, and HNDL  
(DW 95FI)

Date		1996HNDL CONTROL PANEL		Page
2000-06				23
Fig.	Qty	Part No.	Description	Notes
1	1	80 722 67-	Decor insert	-95
2	1	80 706 50	Spring	
3	1	80 706 44-	Pushbotton	-81
4	1	80 706 43-	Main switch casing	-81
5	1	80 575 47	Main switch	
6	1	80 710 77	Hose	9x13x295
7	1	80 706 47	Lock casing	
8	1	80 706 45-	Masking	-77
9	1	80 706 48	Lock washer	
10	1	80 706 49	Lock catch	
	1	89 011 04	Screw	A2-MRT-TT 4x8 T20
11	1	80 710 49	Protective film	
12	1	88 012 03	Control unit	
	1	80 600 76	Contact cover	
	2	89 020 53	Screw	PTK 40x45/15 FZB
	2	89 020 87	Screw	PTK 40x14 WN1452 FZB
13	1	80 597 67	Thermistor	
15	1	80 729 40-	Decor insert	-81
16	1	80 706 40-	Panel	-K -69
	2	89 020 85	Screw	A2-PTK 40x10 WN1452
17	1	80 724 35	Handle	L=560 mm
	2	80 722 69	Tin plate for handle	
18	2	80 724 36	Cross brace, handle	
	2	80 724 39	Screw	MC6S M5x45 8 8 FZB
19	2	80 724 38	Bushing handle	
20	2	80 724 37-	End plugs for handle	-33
21	1	80 734 64	Cable harness complete	
	1	80 730 96	Use and Care Guide	



Model D1996FI, SS, and HNDL  
(DW 95FI)

Date 2000-06	<b>DISHWASHING SYSTEM</b>	Page 24
-----------------	---------------------------	------------





Model D1996FI, SS, and HNDL  
(DW 95FI)

Date		DISHWASHING SYSTEM		Page
2000-06				25
Fig.	Qty	Part No.	Description	Notes
1	1	80 713 37-	Cup shelf, wine glasses	-36
2	1	80 011 99-	Upper basket, w/wheels	-36, with cup shelf
	1	80 727 64-	Glass support, adjustabe	-36
3	1	9- 570 58-	Knife tray , upper cutlery basket	-36
4	1	80 533 76-	Upper cutlery basket	-36
5	1	80 575 05-	Knife stand, upper cutlery basket	-77
6	1	80 725 50-	Cup shelf, divided	-36
7	1	80 575 02	Glide mount 1 for upper cutlery basket	
8	1	80 584 53	Glide mount 2 for upper cutlery basket	
9	1	80 575 03-	Grommet, spray pipe, upper	-77
10	1	80 575 00	Upper spray pipe	
11	1	9- 575 04-	Grommet, spray pipe, lower	-77
12	1	80 575 36-	Lock ring, air break	-77
13	1	80 585 04	O-ring, inlet air break	
14	1	80 575 14	Air break	
15	1	80 597 40	Filter, upper part	
16	4	80 584 98-	Basket wheel, upper	-77
18	1	88 010 89-	Cutlery basket	-77
19	1	88 012 00-	Lower basket	-36
20	8	80 095 16-	Basket wheel, lower	-77
21	1	80 584 93-	Lower basket insert	-36
22	1	80 703 04	Outlet hose	
23	1	80 726 95	Spray arm, upper	
24	2	89 012 62	Nut, spray arm bearing	
25	2	80 520 95	Washer, spray arm bearing	
26	2	80 570 70-	Spray arm bearing	-77
27	1	80 570 68-	Spray pipe bearing, upper	-77
28	1	80 570 63	Spray pipe	
29	2	80 521 89	Hose clip, inlet valve	17.0-706
30	1	80 585 02	Rubber hose, inlet valve	
31	1	80 721 23	Inlet valve	
	2	89 020 87	Screw	PTK 40x14 WN1452 FZB
32	1	80 726 92	Spray arm lower	
33	1	80 570 67-	Spray pipe bearing, lower	-77
34	1	89 017 55	O-ring, lower spray pipe bearing	
35	1	80 570 69	Nut, spray pipe bearing	
36	2	80 574 84	Hose, circulation pump	
37	4	80 520 97	Hose clip, circ. pump hose	44.0-708
38	1	80 550 95	Rubber buffer, circ. pump	
39	1	80 710 24	Level switch (pressure)	
40	1	80 570 53	Float, base pan	
41	1	80 600 68	Microswitch float	
42	1	80 585 00	Rubber hose	5x8x340
43	1	88 011 23-	Base pan, sump	-77
44	1	80 585 03	O-ring, base pan, sump	109.5x3
45	1	80 025 84	O-ring, outlet pump	49.5x3
46	1	80 574 87-	Cover plate	-33
47	1	80 720 32	Outlet pump	
48	1	80 522 39	Hose clip	31.6-708
49	1	80 574 88	Lock ring, bottom well, sump	
50	1	80 584 54	Cover plate	
51	1	80 579 72-	Filter basket, coarse	-77
52	1	80 574 86-	Insert, filter basket	-77
53	1	80 712 50	Circulation pump	



Model D1996FI, SS, and HNDL  
(DW 95FI)

Date 2000-06	<b>INTERIOR LIGHT</b>	Page 26
-----------------	-----------------------	------------

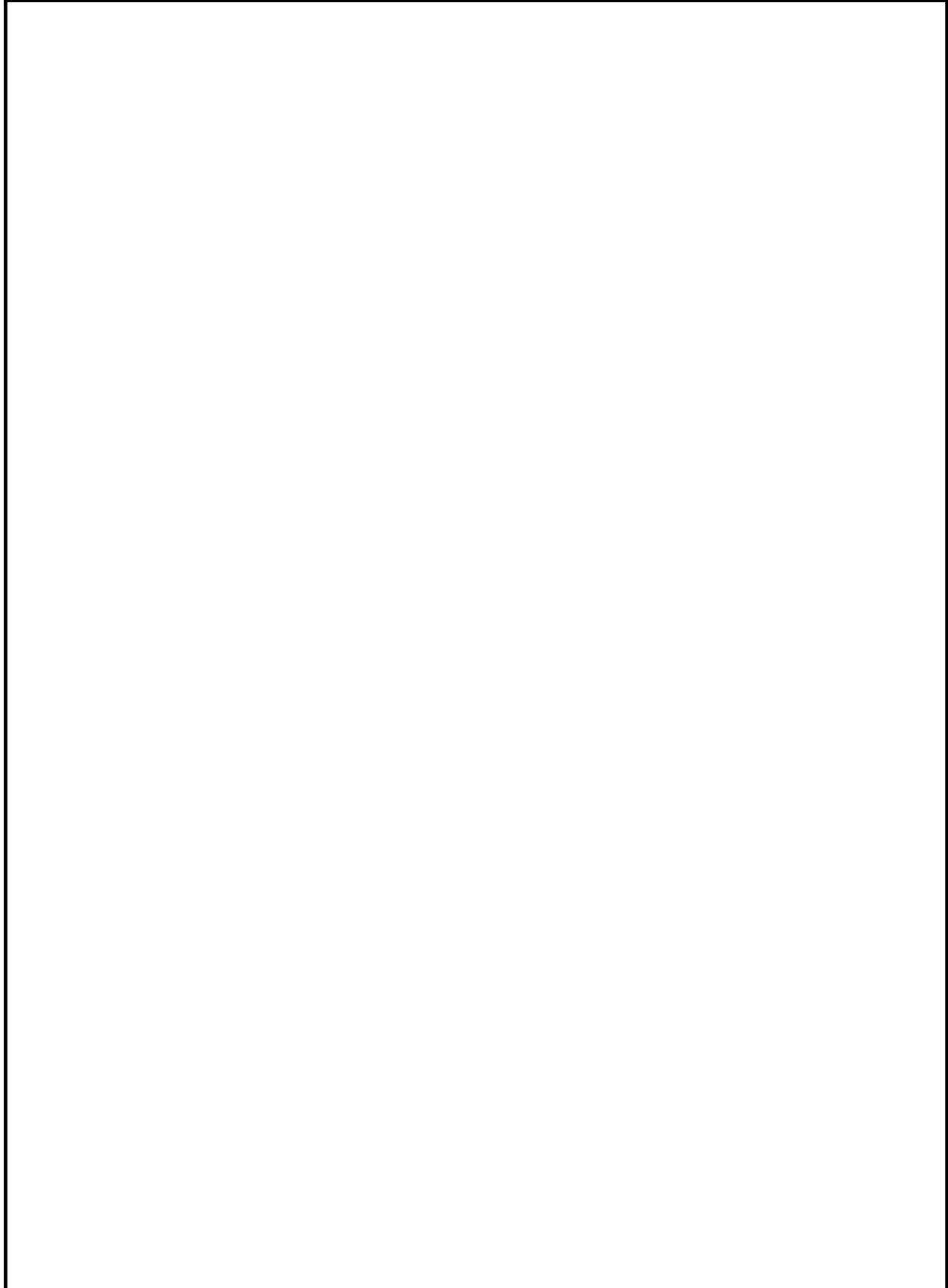



Model D1996FI, SS, and HNDL  
(DW 95FI)

Date		<b>INTERIOR LIGHT</b>		Page
<b>2000-06</b>				<b>27</b>
Fig.	Qty	Part No.	Description	Notes
1	1	80 530 86	Lock ring,glass	UL
2	1	89 017 63	O-ring	65.5x3
3	1	80 530 87	Lamp cover	UL
4	1	80 549 15	Lamp holder	
5	1	80 549 16	Lamp reflector	
6	2	89 015 92	Clip, lamp cover	
7	1	80 551 48	Lamp	
	1	89 012 42	Nut	M6M 4
	1	89 014 13	Washer	AZ 4.3 FZB
	1	89 010 97	Screw	MRT-TT 4x10 FZB T20
8	1	80 599 68	Cable channel	
9	1	80 584 69	Microswitch	
10	1	80 549 07	Bracket,lamp switch	
	1	89 020 87	Screws	PTK 40x14 WN1452 FZB





Product: DW95FI

Date: 99-03-26

**TOPIC: AIR DUCT NOZZLE**

A new plastic nozzle has been developed to reduce problems with condensation from the fan nozzle on our fully integrated machines. These parts can also be fitted to previously manufactured models.

New Part Numbers: 80 722 97 Nozzle for air duct  
80 722 98-29 Strut for nozzle

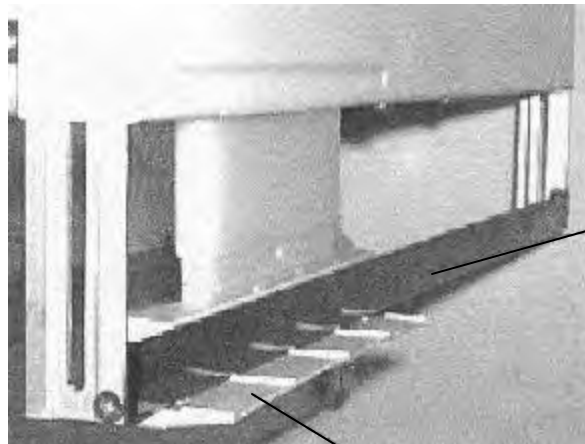

80 722 97

80 722 98-29

The following parts have been discontinued:

80 583 63	Adjustment frame, bottom section
80 708 01	Vapor barrier for wood door
80 598 80	Nozzle for air duct
80 598 91-77	End plug, left
80 598 92-77	End plug, right
80 584 87	Strut for air duct

Date  
**2000-06****SERVICE INFORMATION**Page  
**29**

Product: DW95

Date: 98-03-12

**TOPIC: DOOR SPRINGS**

There are three different sets of door springs, as defined below:

<b>Part Number</b>	<b>Machine</b>	<b>Weight Capacity</b>	<b>Color Coding</b>
80 584 91-77	For all standard machines	9 lbs.	none
80 602 32-77	For integrated and fully-integrated machines	12 lbs.	yellow
80 713 23-77	Heavy-duty for wooden panels, available as accessory part	22 lbs.	red



Color code

Product: DW95

Date: 98-03-13

**TOPIC: WATER LEVEL**

Switch level transferred to measuring points on the coil arm bearing.

**Timer-controlled machines**

Water flow inlet valve = 3.8 +/- 5% ltr / min

Intake time = 60 seconds

- Max. tol. 3.8 +5% = 3.9 ltr +3 mm
- Max. tol. 3.8 +/- 5% = 3.9 ltr +2 mm
- Max. tol. 3.8 -5% = 3.9 ltr +1 mm

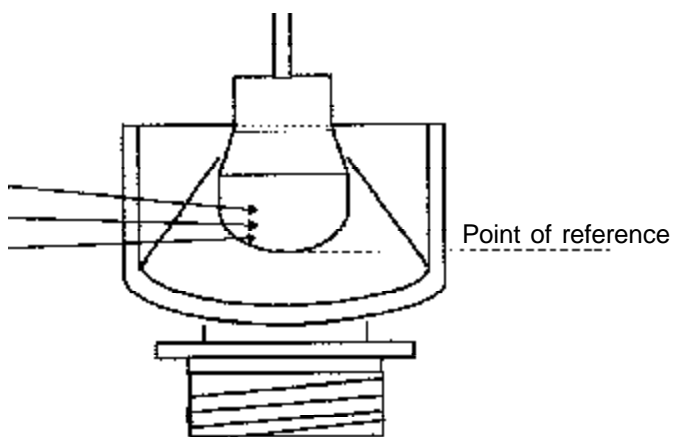

**Electronic machines**

Water flow inlet valve = 3.8 +/- 5% ltr / min

Intake time = 57 seconds

- Max. tol. 3.8 +5% = 3.7 ltr +1 mm
- Max. tol. 3.8 +/- 5% = 3.51 ltr +0 mm
- Max. tol. 3.8 -5% = 3.3 ltr -1 mm

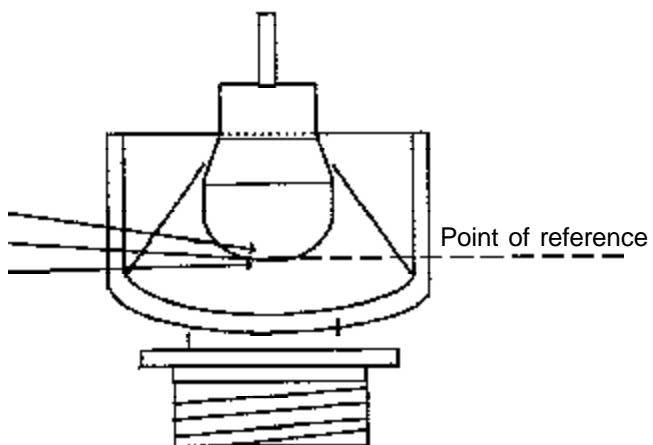

**Note:** Start with dry bottom well, which gives a 2mm lower level.



Date  
**2000-06****SERVICE INFORMATION**Page  
**31**

Product: DW95

Date: 98-03-13

**TOPIC: GUIDE PIN FOR DOOR LOCK**

Occasionally, the guide pin for the door lock may freeze or become stuck, causing the machine not to stop when the door is opened. To prevent this, you can lubricate the guide pin with petroleum jelly.

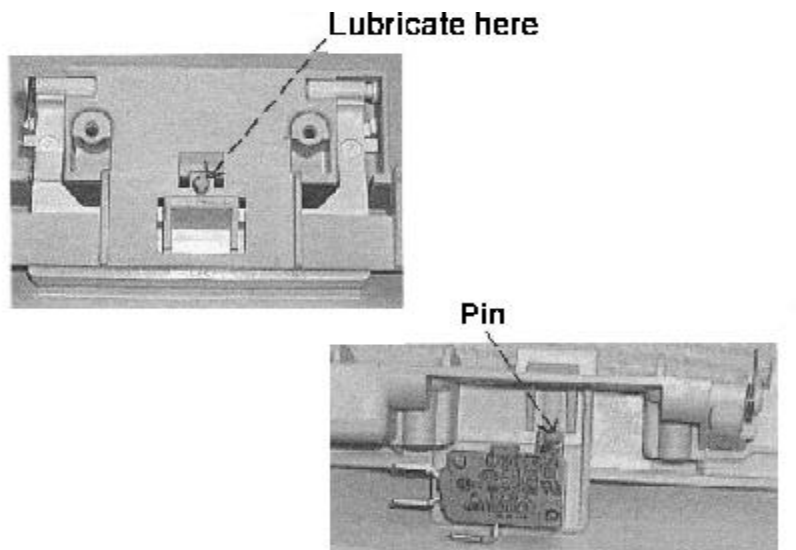

Date <b>2000-06</b>	<b>SERVICE INFORMATION</b>	Page <b>32</b>
------------------------	----------------------------	-------------------

Product: DW95

Date: 98-03-13

**TOPIC: CONTROL UNIT FAILURE ANALYSIS**

To prevent repeated exchanges of control units due to failures in auxiliary components (circulation pumps, inlet valves, etc.), a simple check on the control unit should be done to determine what cause the failure.

If any of the control unit components listed below or the conductive pattern (copper foil on the soldering side) near these components are damaged, most likely the external component caused the failure and should be ohm-measured. In the case of short-circuits, the components should be exchanged along with the control unit.

<b>External Component</b>	<b>Associated Output Components</b>
Heater	K1, PF2
Drain pump	K2, P1 5
Circulation pump	K3, P1 3
Inlet valve 1	Q13, R36, R52, D22, D24, P1 7
Combi-dispenser	Q12, R50, R58, D21, D23, P2 3
Fan and wax motor	Q16, R46, R56, D18, D19, P3 3
Interior light	P4 3 (after 9740, the lamp is not connected to the control unit.)

K=Relay  
Q=Triac  
R=Resistor  
D=Diode  
P=Connector

**Note:** Once the wax motor has dried out, it is not possible to measure for faults. Remove the wax motor and check for burn marks. For complete certainty, replace the wax motor.