



Service manual Dishwashers

Type: DW70

Contents

1. Introduction.....	4
1.1 Models	5
2. Technical data	6
2.1 Technical information.....	6
3. Installation.....	7
4. Component information.....	9
4.1 Components and measurement values	9
4.2 Components and function description	11
5. Programs and control unit.....	14
5.1 Programs.....	14
5.2 Time display	15
5.3 Programs and options	15
5.4 Wiring diagram and timer diagram	17
5.5 Program flow description	18
5.6 Settings	19
5.7 Service menu	25
6. Troubleshooting.....	28
6.1 Dishwashing results	28
6.2 Most common faults.....	28
6.3 Water level.....	29
6.4 Fault indications	30
7. Tools.....	32
7.1 Tools.....	32
7.2 Special tools	32

INTRODUCTION

1. Introduction

You are holding ASKO's service manual for the DW70 generation of dishwashers.

The DW70 dishwasher series is available in five different basic models, designated DW70.1, DW70.3, DW70.4, DW70.5 and DW70.C. On the next page, we present the various panels found on each type, making it easy to identify the different machines. The different models are named differently in different markets. The type designation is most important when identifying a particular machine model.

The type plate can be found on the right of the inside of the door.

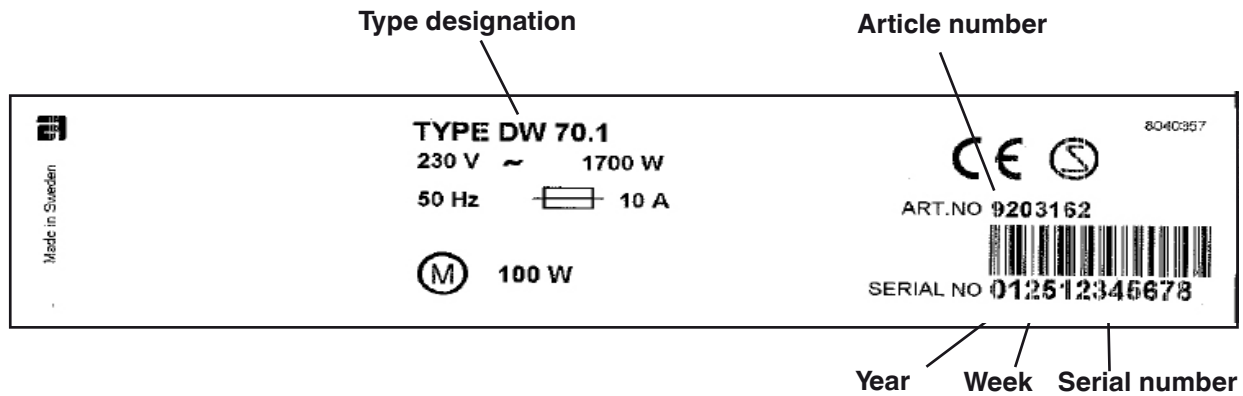

The first two digits specify the year of manufacture while the third and fourth digits specify the week of manufacture.

It should be easy to service a dishwasher. It is important that you, as a service technician, are afforded conditions that enable you to work in an efficient and satisfactory way. Our hope is that this service manual will prove a useful tool in your daily work.

Asko Appliances/After Sales
Box 344
SE-532 24 Skara
Sweden

INTRODUCTION

1.1 Models

DW70.1

The DW70.1 is available in two versions, with either one or two options. The machine has four set programs and the controls are on the front of the panel.



DW70.3

The DW70.3 is available in two versions – with three and five options respectively. The machine has six set programs and the controls are on the top..

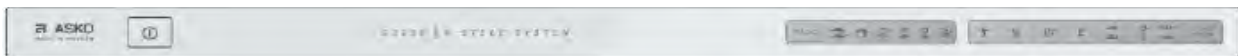

DW70.4

The DW70.4 has a number of different options. The machine has 14 set programs. The controls are on the top and the display (LCD) is on the top of the panel.



The DW70.3 and DW70.4 models are used in both fully integrated and standard models. Other control units are only used in standard models.

DW70.5

The DW70.5 is available in two versions – with three and five options respectively. The machine has five set programs and the controls and display are at the front.

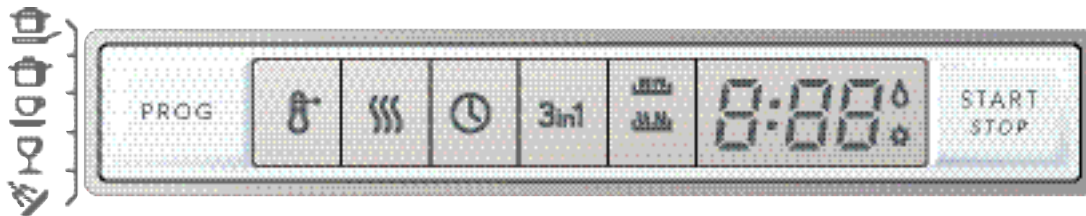

DW70.C

DW70.C

The machine has six set programs and the control and the display are on the front of the panel.



TECHNICAL DATA

2. Technical data

2.1 Technical information

Height:	823-870 mm (32-1/4" to 35-1/2") = for 820 mm machines (XL) 863-910 mm (33-3/4" to 36") = for 860 mm machines (XXL)
Width:	596 mm (23-5/8")
Depth:	570 mm (22-7/8")
Weight:	42 kg / 45 kg with water softener
Water pressure:	0.03–0.2 MPa (0.3–2.0 kp/cm ²), 18-176 psi
Connection:	1-phase, 230 V, 50 Hz, 10 A, (120V, 60 Hz, 15 A)**
Max. rated power:	1700 W, (1300 W)**

* According to EN 50242 standard.

** See type plate.

INSTALLATION

3. Installation

Suggested machine installations

The dishwasher can be installed built-in, completely freestanding or partially free-standing.

CAUTION!



Connections to electricity, water and drain must be performed by qualified professionals.

A. Built-in

The dishwasher can be installed under a worktop and integrated with the kitchen cupboards. Read the instructions in the user manual and the installation instructions for the actual machine type.

B. Freestanding

A freestanding machine must be fitted with an anti-tilt device. This comprises two brackets, which are screwed into place as illustrated in figure 1. An alternative to the anti-tilt device is a counterweight that is fixed directly to the back of the machine.

Push in the machine so that the rear feet slide into the mounting brackets. Now the machine will not tip over if a load is placed on the door when open. If the machine is installed completely freestanding, side panels and a worktop should be fitted. These accessories can be purchased where you bought the dishwasher.

C. Partially freestanding

If you install the machine so that either side is visible, you can fit a side panel.

D. Machines with wooden door

Stronger door springs are available for purchase for machines with a fitted wooden door. Springs are available for various weights and sizes of wooden door. Door springs can be purchased where you bought the dishwasher. Follow the instructions in the installation manual for fitting the wooden door.

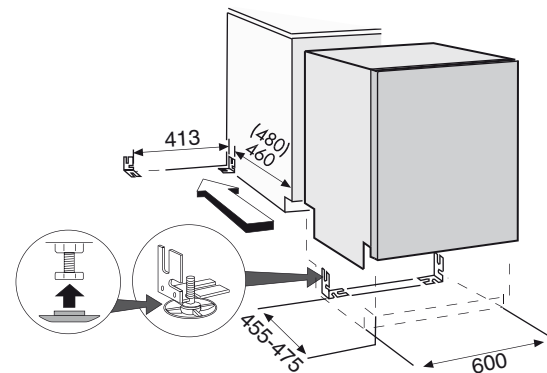

Figure 1. Anti-tilt brackets used for freestanding installation

CAUTION!



A completely freestanding machine must be fitted with an anti-tilt device/counterweight.

INSTALLATION

Connection to water supply

The supply pipe must be fitted with a stopcock. The stopcock should be positioned above the sink unit or at the front of the sink unit cabinet.

The inlet pipe has a coupling with either a 1/2" or a 3/4" internal thread, depending on the country.

Once the machine is installed: Open the stopcock to flush the pipe. Check that all connections are watertight.

Electrical connection

Machines fitted with a cable and plug must be connected to an earthed socket.

Technical data

See the type plate on the right-hand side of the door.

CAUTION!



The power cable must be disconnected or the power to the socket turned off when work is carried out!

Drain connection

• The drain hose connects to a connection nipple on the sink unit's water trap (see illustration below). Note that the hose must be attached at the same height as the underneath of the sink unit otherwise dishwater from the sink may run down into the dishwasher (see illustration).

• The drain hose connects to a connection pipe on the sink unit's water trap. It must have an internal diameter of at least 16 mm.

• The drain hose may be extended to a maximum of 3 m. Any connections and connecting pipes must have an internal diameter of at least 16 mm.

• No part of the drain hose may be more than 950 mm above floor level.

The hose must not be routed directly to the floor drain or similar. In such cases, the hose can act as a siphon and empty the machine.

The hose must always discharge at least 350 mm above floor level.

• Attach the hose holder.
(Min. 350 mm and max. 950 mm above floor level.)

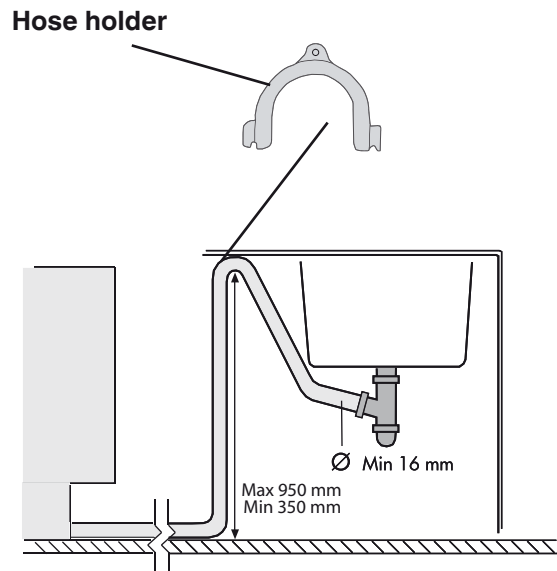

Figure 3.

COMPONENT DESCRIPTION

4.Component description

4.1 Components and measurement values

The specified resistance values apply at room temperature (about 20°C/68°F)

Values within ±10% are considered normal.

Article no.	Position	Component	Measurement value
8073779		EMC filter	680 kohm
8073780,81		EMC filter	1 Mohm
8079504		Heater 1600 W 230 V	32 ohm
8079505		Heater 1200 W 120 V	12 ohm
8078096		Thermistor	60 kohm
8073801,02		Combi disp. 230 V	1.6 kohm
8073803,04		Combi disp. 120 V	0.3 kohm
8078080		Circ. pump 220/240 V 50 Hz	Primary winding 115 ohm
8078080		Circ..pump 220-240 V 50 Hz	Auxiliary winding 260 ohm
8078082		Circ..pump 120 V 60 Hz	Primary winding 31,4 ohm
8078082		Circ..pump 120 V 60 Hz	Auxiliary winding 76 ohm
8078087		Drain pump 200/240 V 50 Hz, 16 l/min	148 ohm
8078089		Drain pump 120V 60 Hz, 16 l/min	26 ohm
8078084	2-3	Spray arm diverter 230 V 50/60 Hz	8.5 kohm
8078085	2-3	Spray arm diverter 120 V 60 Hz	2.6 kohm
8079502		Inlet valve single 200/240 V, 4 l/min	3.9 kohm
8079503		Inlet valve single 120 V, 4 l/min	0.95 kohm
8079500		Inlet valve fuse 220/240 V, 4 l/min	2 kohm
8079501		Inlet valve fuse 120 V, 4 l/min	0.5 kohm
8078090*		Softener salt water valve 220/240 V	3 kohm
8078090 *		Softener mixer valve 220/240 V	2.33 kohm

COMPONENT INFORMATION

Article no.	Position	Component	Measurement value
8078302*		Softener salt water valve 120 V	0.65 kohm
8078302*		Softener mixer valve 120 V	0.65 kohm
8073830		Halogen bulb 5 W/12 V	<10 kohm
8052778		Vax motor	1.1 kohm
8073850		Fan motor 230 V	0,44 kohm
8073848		Fan motor 120 V	0.18 kohm
* The number is for a complete water softener; replacement salt and mixer valves are not available separately.			

4.2 Components and function description

Here we present the functions and specifications of the various electrical components. Some components are only found in high-end machines or in particular markets.

Inlet valve

Both single and safety inlet valves are used. The valve contains a filter to stop particles then a flow limiter to limit the flow to a maximum of 4 l/min. The valve opens when the water pressure exceeds 0.3 bar and provides full flow at about 2 bar.

Safety valve

The safety valve has two independent valve seats, each controlled by a separate electromagnet. The valve seats are connected in series. This doubles the safety factor. The electromagnets are also connected in series (electrically), which means each magnet's rated voltage is half the mains voltage (e.g., a 230 V valve = 2 x 115 V coils)

Single valve

The single valve comprises an electromagnet and a valve seat.

Flow meter

The flow meter is fitted in the air gap. The flow meter is used to control the water intake so that the right volume is taken in regardless of the water pressure. It is even possible to program the machine for time-controlled water intake.

The flow meter comprises an impeller with two magnets that is driven by the water flow. On the outside, on the flow meter housing, is a sensor, a reed switch, which closes each time the magnets pass. The number of pulses from the sensor is proportional to the volume of the flowing water. A minimum water flow of 2 litres/minute is required for the flow meter to operate. If the necessary level is not reached within one minute, the program stops.

Output signal: 220 pulses per litre.

Circulation pump

The circulation pump comprises an asynchronous motor, with a pump house capacitor.

COMPONENT INFORMATION

Spray arm diverter

Certain machines are fitted with a spray arm diverter. The spray arm diverter comprises a synchronous motor that drives a disc valve via a gearbox. The disc distributes different amounts of water from the circulation pump to the lower and upper spray arms at different pressures. The motor/gearbox also drives a cam with four different step times. A switch detects the cam (step time) and provides the control unit with feedback on its current position when setting the desired spray arm status.

Note that the spray arms never rotate at the same time. The spray arms can report the following status:

- Upper spray arm half or full pressure
- Lower spray arm half or full pressure

Depending on the program, dishwashing stage and options, the spray arms are set to various intervals and pressures.

Machines that lack a spray arm diverter utilise a water distributor instead, which routes the water to both spray arms. The spray arms always rotate at the same time.

Heater

The heater is of the flow-through type and is fitted between the bottom drain and the suction side of the circulation pump. It comprises a pipe with a heating coil. One side of the heating coil is fitted with an overheating cut-out with a trigger temperature of 98°C and an automatic reset. The other side is fitted with a safety fuse that blows at 229°C.

Drain pump

The drain pump comprises a 30 W synchronous motor and a pump component. The direction of rotation is random, making the pump partially self-cleaning.

Fan

The fan extracts the damp air from the machine during the drying phase of the program. The fan system has a fan motor that drives a double-sided fan wheel. Dry air is sucked in from the opening on one side of the fan wheel. The hot and damp air from the cleaning compartment is drawn through the other side of the fan wheel, when a Vax motor opens a damper. This is done with a slight delay. Dry and damp air are mixed in a conduit that ends at the top of the door, where the air is expelled through a nozzle.

Detergent and rinse aid dispenser

The detergent and rinse aid dispenser is fitted with an electromagnet which upon first activation dispenses detergent and upon second activation dispenses rinse aid. The system is reset when the dishwasher door is opened.

The dispenser contains a chamber of adjustable volume to set the desired rinse aid dose. The rinse aid level can be checked using the optical indicator on the top of the dispenser. Some models have a sensor, a reed switch, fitted to the dispenser. This measures the rinse aid level, which is then indicated on the panel.

Main power switch

The main power switch has 2 pins and breaks the phase and the earth. However, power to the filters, overflow cut-out, drain pump and inlet valve is not cut when the main power switch is turned off.

On the DW-70.4 the main power switch is electronic and is integrated with the control unit. It puts the machine into standby mode when deactivated.

EMC protection

EMC protection ensures that the machine does not interfere with nearby electrical equipment. It also protects the machine from external interference.

COMPONENT INFORMATION

Door switch

A micro switch detects when the door has been opened. The program is paused and power to certain components (motor, valves etc.) is cut. The program continues where it left off when the door is closed.

Overflow cut-out

The overflow cut-out comprises a float that triggers a micro switch. This switches off the inlet valve electrically and starts the drain pump. The protection remains in place even if the main power switch is turned off.

Light

The light is a 5 W/12 V halogen bulb powered by a control unit via a micro switch. The lamp turns on when the door is opened more than 5°. The lamp is dimmed when lit to reduce the start current and to extend the life of the bulb. The control unit features protective components that limit the current to the light in case of a short circuit or if a bulb with too high a power rating is fitted. The bulb can be replaced from inside the cleaning compartment.

Cables

The machine is fitted with coded connectors to prevent incorrect wiring. The cables comply with the Rast 2.5 and Rast 5 standards.

Water softener

The water softener softens the intake water to prevent limescale deposits on dishes and in the machine. The ion exchange resin is recharged by opening the salt water valve (found on the water softener) and releasing water saturated with salt into the ion exchange chamber during the main wash. The ion exchange chamber is rinsed clean at the end of the main wash.

A mixer valve on the water softener controls the water passing through or bypassing the ion exchange resin. The higher the water softener setting, the greater the amount of water pass-

ing through the ion exchange resin. When the mixer valve is open, the water bypasses the ion exchange resin.

Some models have a sensor, a reed switch, to detect when the salt needs refilling. Other models use an optical indicator in the salt filling hatch.

Air gap

On the side of the machine is an anti-back-flow device to prevent dirty water from being siphoned back into the water system, such as if a vacuum develops in the water system. Machines with a water softener also have a water pocket that is filled with about 2 dl of water. This water pocket is emptied when the salt water valve is activated.

Thermistor

The thermistor is at the front edge of the bottom drain and detects when the selected water temperature has been reached. If the thermistor is short-circuited or detaches from the circuit board, the heater is turned off.

Pressure sensor

The pressure sensor is connected to the pressure chamber in the bottom drain. It measures the pressure, which corresponds to the water level in the machine. If the water level in the machine is too high (for five consecutive seconds) the drain pump starts and all other components are switched off. When the right level is reached, the program continues where it left off. If the level sensor generates an output signal of <1 VDC during the prewash (indicating a blocked filter), an additional prewash is activated with an SCS step.

The level sensor also controls the draining time (can be extended from 25 seconds to a maximum of 3 minutes). Does not apply to DW-70.1 The sensor also checks the need to refill (such as if a bowl fills with water). Does not apply to DW-70.1

COMPONENT INFORMATION

Turbidity sensor

Machines with an auto program have a turbidity sensor that measures how cloudy the water is. The sensor comprises an LED and a phototransistor. Between these two is the dishwasher. The less light that reaches the phototransistor, the cloudier the water. The sensor is calibrated during the last rinse of the auto program. At different points during the auto program the output signal from the turbidity sensor provides data used to determine how the program will continue (number of prewashes, temperature, program time, number of rinses and so on).

If the turbidity sensor fails, the machine assumes the water is “very cloudy”, which results in a longer program time, prewashes, additional rinses and so on.

The turbidity meter is located at the front edge of the bottom drain.

Humidity sensor

The humidity sensor is located in the fan house. The sensor is of the capacitive type and measures relative humidity. The humidity sensor measures the ambient humidity before the drying process begins. The drying process continues until the humidity sensor detects a level slightly above ambient humidity (min. time 30 min. and max. time 70 min.).

PROGRAMS AND CONTROL UNIT

5. Programs and control unit

5.1 Program

* (only with turbidity sensor)
 ** (only spray arm diverter)
 *** (only duo machines)

A-F (program alternatives)

Program	Machine type					
	DW70.1	DW70.3	DW70.5	DW70.4	DW70.C	
Auto wash*		A	A	X		
Daily wash		A	A	X		
Heavy wash	A	B	B	X		
Sani***				X	X	(EU,AU)
Pots & Pans***				X		(US)
Normal wash	B	C	C	X	X	
Mixed wash**				X		
Upper half wash**				X		
Lower half wash**				X		
Time program			D	X		
Glass/Delicate wash		D		X	X	
Quick wash	C	E	D	X	X	
Rinse & Dry				X		
Rinse & Hold	D	F	E	X	X	

The table below shows which dishwashing processes are activated in each program.

L = Low temperature M = With fan
 H = High temperature U = Without fan

Program	1st pre-wash		2nd pre-wash		1st flush		Main wash		Clean dr. pump		2nd Flush		1st rinse		2nd rinse		Clean dr. pump		Final rinse		Drying time L (min.)		Drying time H (min.)	
	L	H	L	H	L	H	L	H	L	H	L	H	L	H	L	H	L	H	M	U	M	U		
Temp & drying options	L	H	L	H	L	H	L	H	L	H	L	H	L	H	L	H	L	H	M	U	M	U		
Daily wash	X	X		X		X*	X	X	X		X	X	X	X			X	X	20		30			
Heavy wash	X	X	X	X	X	X	X	X			X	X	X	X	X	X	X	X	48	30	48	30		
Sani (duo wash EU/AU)							X	X			X	X	X	X			X	X	48	30	30	30		
Pots & Pans (duo wash US)	X	X	X	X	X	X	X	X	X	X	X	X	X	X			X	X	48	30	30	30		
Normal wash	X**	X		X		X*	X	X			X	X	X	X		X	X	48	30	30	30			
Mixed wash							X	X			X	X	X	X			X	X	48	30	30	30		
Upper half wash							X	X			X	X	X	X			X	X	48	30	30	30		
Lower half wash							X	X			X	X	X	X			X	X	48	30	30	30		
Time program 30-60 min.							X	X	X	X	X	X	X	X			X	X	0-9					
Time program 75-105 min.	X	X					X	X	X	X	X	X	X	X			X	X	12-25					
Time program 120-135 min.	X	X	X	X			X	X	X	X	X	X	X	X			X	X	25-40					
Time program 150-180 min.	X	X	X	X			X	X	X	X	X	X	X	X	X	X	X	X	49-60					
Glass/Delicate wash							X	X			X	X	X	X			X	X	20	20	30	30		
Quick wash							X	X			X	X	X	X			X	X	0					
Rinse & Dry																	X	X	20					
Rinse & Hold														X	X				0					

* only US

** US/AU

PROGRAMS AND CONTROL UNIT

5.2 Time display

DW70.1: The program progress lamps around the Start button light up as the program progresses (segment 1 for prewash, segments 1 and 2 for main wash and so on).

DW70.4, DW70.5 When a program is selected the display indicates how long the program took the last time it was used. After the program starts, the time counts down in one-minute intervals (no recalculation during the program). The new time is not stored if any faults occur during the program or if the program is interrupted.

Option	Machine type				
	DW70.1	DW70.3	DW70.5	DW70.4	DW70.C
Temperature	1	1	1	X	X
Drying	2	2	2	X	X
Delayed start		3	3	X	X
Time saver		4	4	X	X
Super rinse		4	4	X	X
Tab***		4	4	X	X
Set Time.*			4	X	X
Basket loading**		5	5	X	X
Cool touch				X	X

* (only Time program)

** (only spray arm diverter)

*** (For detergent with water softener)

1-5 (option alternatives)

5.3 Programs with options

Program	Option									
	Temperature	Drying	Delayed start	Time saver	Super rinse	Tab	Full load	Upper load	Lower load	Cool touch
Auto wash		X*	X			X	X	X	X	
Daily wash	X	X	X		X	X	X	X	X	X
Time program			X			X	X	X	X	
Heavy wash	X	X	X	X	X	X	X	X	X	X
Sani	X		X		X	X	X	X	X	X
Pots & Pans	X	X	X		X	X	X	X	X	X
Normal wash	X	X	X	X	X	X	X	X	X	X
Mixed wash	X	X	X	X	X	X				X
Upper half wash	X	X	X	X	X	X				X
Lower half wash	X	X	X	X	X	X				X
Glass/Delicate wash	X**	X	X		X	X	X	X	X	X
Quick wash	X	X	X		X	X	X	X	X	X
Rinse & Dry			X				X	X	X	
Rinse & Hold		X	X				X	X	X	

* Humidity sensor
 ** (C-60°C)

PROGRAMS AND CONTROL UNIT

5.4 Wiring diagram

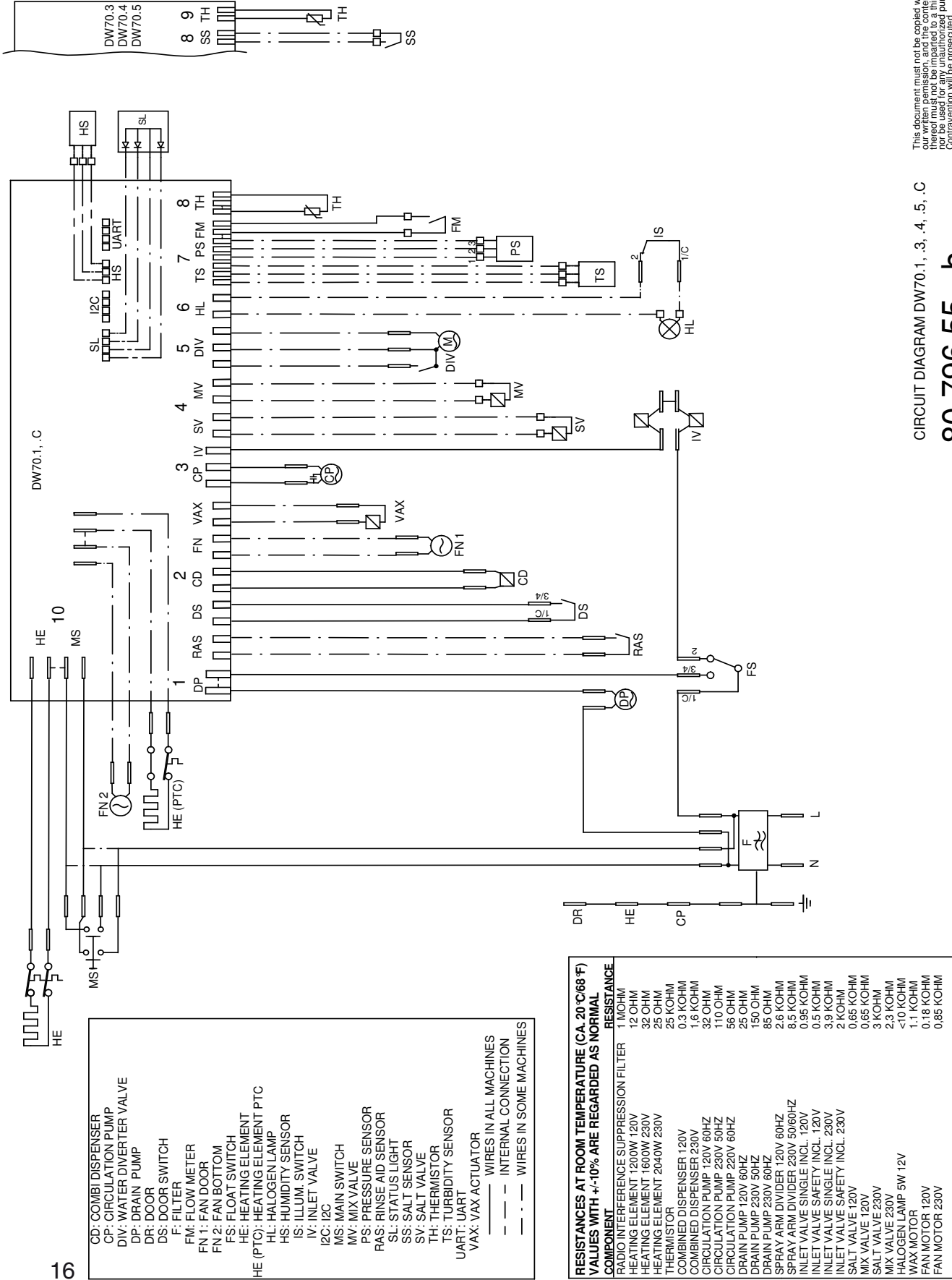

This document must not be copied without our written permission, and the contents thereof must not be imparted to a third party nor be used for any unauthorized purpose. All rights are reserved. © 2005 Asko Cylinda AB

CIRCUIT DIAGRAM DW70.1, .3, .4, .5, .C

80 796 55 - b

FORMAT A3

PROGRAMS AND CONTROL UNIT

5.4 Timer diagram

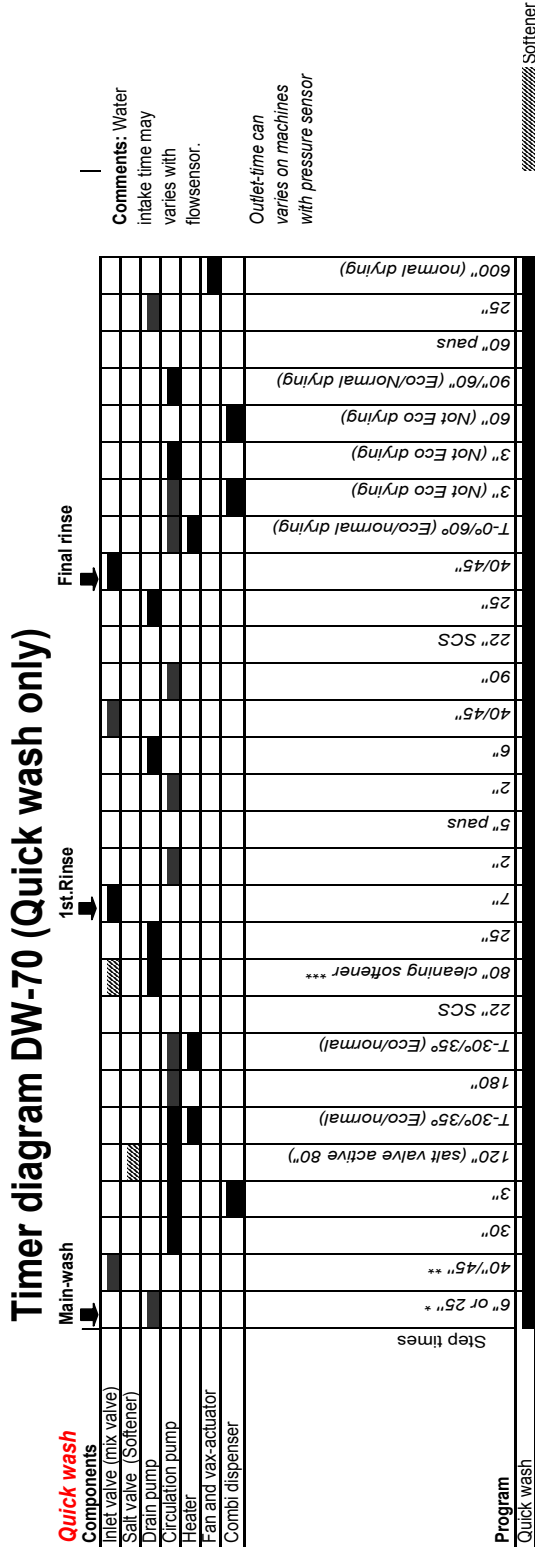

* If previous program been interrupted = 25"

** With or without diverter

*** Inlet valve on 8"x 5, off 8" x5. Outlet pump on whole step

Explanation chart for water divider dishwasher DW-70

Programs	Auto, Normal, Quick, Rinse programs		Heavy wash		Delicate wash								
	Both (normal)	Mixed wash	Both (normal)	Upper basket wash	Lower basket wash	Mixed wash							
Lower spray arm	low pressure	30	10	50	40	15	10	30	20	50	10	90	70
Upper spray arm	High pressure	30	10	50	40	45	10	70	60	10	10	10	10
	low pressure	30	50	10	30	15	30	10	20	50	90	10	30
	High pressure	30	50	10	10	45	70	10	20	10	10	10	10

Time in seconds for water divider action

PROGRAMS AND CONTROL UNIT

5.5 Program flow description

Presented below is the Quick program. If the component test in the service menu is not sufficient to identify a fault you can run this program and compare the results with the flow description below. If they are in agreement this indicates a correctly functioning control unit.

Component	Time	Comments
Main wash		
Drain pump	6 sec.	25 sec. if the previous program was cancelled with the Start/Stop button
Inlet valve	40/45 sec.	With/without diverter
Circ. pump	30 sec.	
Circ. pump & Combi dispenser	3 sec.	
Circ. pump	120 sec.	
Circ. pump & Element T-30°/35°		Eco/Normal temp
Circ. pump	180 sec.	
Circ. pump & Element T-30°/60°		Eco/Normal temp
SCS	22 sec.	Super Clean System
Drain pump	25 sec.	
1st rinse		
Inlet valve	7 sec.	
Circ. pump	2 sec.	
Pause	5 sec.	
Circ. pump	2 sec.	
Drain pump	6 sec.	
Inlet valve	40/45 sec.	With/without diverter
Circ. pump	90 sec.	
SCS	22 sec.	Super Clean System
Drain pump	25 sec.	
Final rinse		
Inlet valve	40/45 sec.	With/without diverter
Circ. pump & Element T-0/60°		Eco/Normal drying
Circ. pump & Combi dispenser	3 sec.	None Eco drying
Circ. pump	3 sec.	No Eco drying
Circ. pump & Combi dispenser	60 sec.	No Eco drying
Circ. pump	90/60 sec.	Eco/Normal drying
Pause	60 sec.	
Drain pump	25 sec.	
Fan	600 sec.	Normal drying

PROGRAMS AND CONTROL UNIT

5.6 Settings

DW70.1

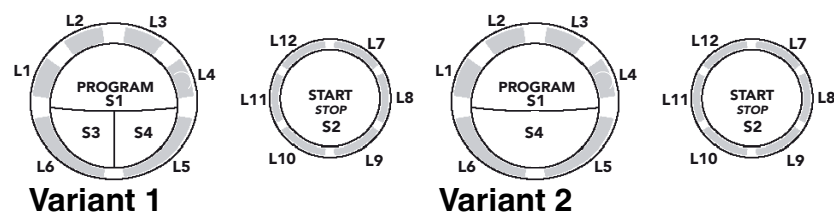

Panel type DW70.1, L = LED, S = Push button

Variant settings

When the power is switched on for the first time after replacing the control unit, the variant settings menu is displayed.

L1 flashes: Variant 1 see above, with two options (temp, dry).

L4 flashes: Variant 2 see above, with one option (temp).

1. Press the Program button (S1) until either L1 or L4 flashes.
2. Confirm your selection by pressing Start (S2). (The program automatically returns to the main menu.)

To return to the variant settings menu:

1. Turn off the main power switch (I/O)
2. Wait at least 5 seconds
3. Press and hold the Program and Start buttons (S1 & S2)
4. Switch off the main power switch (I/O)
5. Release the Program and Start buttons (S1 & S2)
6. Press Start (S2) three times within 5 seconds. Use the Program button (S1) to select the variant
7. Confirm your selection by pressing Start (S2). The program returns to the main menu.

Water hardness setting

Activating the settings menu

1. Turn off the main power switch (I/O)
2. Wait at least 5 seconds
3. Press and hold the Start button (S2)
4. Switch off the main power switch (I/O)
5. Release the Start button (S2); L7 starts flashing
6. Use the Program button (S1) to select the desired water hardness

Setting: Water hardness

[°dH] (German water hardness scale)

All LEDs unlit	0-5
(also applies to machines without water softener)	
L1 lit	6-8
L1-2 lit	9-14
L1-3 lit	15-19
L1-4 lit	20-29
L1-5 + L11 lit	30-44
L1-6 + L11 + L12 lit	45+

Confirm your selection by pressing Start (S2). The program returns to the main menu.

Total reset

To reset the machine to its factory settings.

1. Turn off the main power switch (I/O)
2. Wait at least 5 seconds.
3. Press and hold the Program button (S1)
4. Switch off the main power switch (I/O)
5. Release the Program button (S1).

L1 and L4 flash during the reset process. The machine will reset various settings, although not water hardness, and then automatically return to the main menu. Detects the presence of a pressure sensor.

PROGRAMS AND CONTROL UNIT

DW70.3

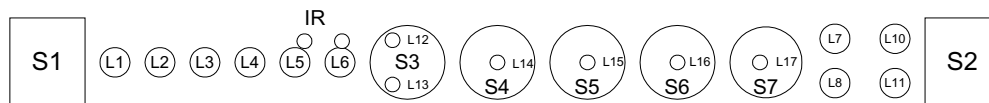

Panel type DW70.3, L = LED, S = Push button,

Variant settings

When the power is switched on for the first time after replacing the control unit, the variant settings menu is displayed.

1. Press the Program button (S1) until the desired variant is selected:
L1 flashes:
 Variant1 = Time saver
L2 flashes:
 Variant2 = Super rinse option
L3 flashes:
 Variant3 = Tab
2. Confirm your selection by pressing Start (S2). The machine detects the presence of a turbidity sensor, a pressure sensor and a spray arm diverter. The program returns to the main menu.

Setting	Water hardness[°dH]
L1-L6, off	0-5 (incl. machines without extinguished water softener)
L1 lit	6-8
L1-2 lit	9-14
L1-3 lit	15-19
L1-4 lit	20-29
L1-5 lit	30-44
L1-6 lit	45+

To return to the variant settings menu:

1. Turn off the main power switch (I/O)
2. Wait at least 5 seconds
3. Press and hold the Program and Start buttons (S1 and S2)
4. Switch on the main power switch (I/O)
5. Release the Program and Start buttons (S1 and S2). Proceed to step 6 within five seconds.
6. Press Start (S2) three times in quick succession. L1, L2 or L3 flashes according to the previously selected variant setting
7. Use the Program button (S1) to select a variant
8. Confirm your selection by pressing Start (S2). The program returns to the main menu.

Activating of Super rinse (Variant 1 and 3; S7)

Activating the settings menu:

1. Turn off the main power switch (I/O)
2. Wait at least 5 seconds
3. Press and hold the button (S7)
4. Switch on the main power switch (I/O)
5. Release the button (S7)
6. Use the Program button (S1) to select the desired status
 L1 unlit: Super rinse deactivated
 L1 lit: Super rinse activated
7. Confirm your selection by pressing Start (S2). The program returns to the main menu.

Water hardness setting

1. Turn off the machine using the main power switch. ①
2. Press and hold START/STOP and Drying selector at the same time as you press the main power switch once. You have now activated the Softener setting menu.
 START/STOP +))) + ①
3. Use the Program button **PROG** to adjust the water hardness.
4. Press START/STOP to save the setting and exit the menu.

PROGRAMS AND CONTROL UNIT

Child safety catch

Activating the settings menu:

1. Turn off the main power switch (I/O)
2. Wait at least 5 seconds
3. Press and hold the temperature and drying option buttons (S4 and S6)
4. Switch on the main power switch (I/O)
5. Release the temperature and drying option buttons (S4 and S6)
6. Use the Program button (S1) to select the status

L1 unlit: Child safety catch deactivated

L1 lit: Child safety catch activated

Confirm your selection by pressing Start (S2). The program returns to the main menu.

Temporary deactivation of the Child safety catch is achieved by pressing the temperature (S4) and drying (S6) option buttons together.

Total reset

To reset the machine to its factory settings.

1. Turn off the main power switch (I/O)
2. Wait at least 5 seconds
3. Press and hold the Program button (S1)
4. Switch on the main power switch (I/O)
5. Release the Program button (S1).

The machine will reset various settings, although not water hardness, variant setting and intake volume. The machine detects the presence of a turbidity sensor, a pressure sensor and a spray arm diverter. The machine then automatically returns to the main menu.

PROGRAMS AND CONTROL UNIT



DW70.4

Panel type DW70.4, L = LED, S = Push button

Special settings

Turn on the main power switch, press the Menu button (S4) a few times until the special settings are displayed.

The following settings are available:

Language, child safety catch, program end signal, button tones, temperature (C or F), water hardness setting.

This menu can also be used to view information about how many cycles the machine has completed and total water consumption.

Water hardness setting:

Setting: Water hardness
[°dH]

The display shows: 0 0-5

(also applies to machines without water softener)

The display shows: 16-8

The display shows: 29-11

The display shows: 312-14

The display shows: 415-19

The display shows: 520-24

The display shows: 625-29

The display shows: 730-39

The display shows: 840-49

The display shows: 950+

Press S3 until the desired setting is shown. Confirm with S4. The program stores the settings and returns to the main menu.

Store program (in shops, at trade shows etc.)

Start by pressing and holding S4 with the main power switch (S5) turned on.

Scrolling text is displayed:

“Turbo Drying ...Super Cleaning System...Auto Wash...Flexi Racks...Power Zone...8 Steel.....Turbo Drying...”

Quit by pressing the main power switch.

Total reset

After replacing the control unit, the machine will automatically perform a total reset, which will detect the presence of the machine’s sensors and spray arm diverter.

To return to total reset:

1. Turn off the main power switch (I/O)
2. Wait at least 5 seconds
3. Press and hold the Program and Menu buttons (S1 and S4)
4. Switch on the main power switch (I/O)
5. Release the Program and Menu buttons (S1 and S4).

The machine will reset various settings, although not water hardness, language, variant and intake volume. The machine detects the presence of a turbidity sensor, a pressure sensor, a humidity sensor and a spray arm diverter. The machine then automatically returns to the main menu.

Quick language setting

1. Turn off the main power switch (S5)
2. Wait 5 sec.
3. Press and hold S3
4. Switch on the main power switch (S5)
5. Release S3
6. Use the Program button (S1) to browse to the desired language
7. Confirm your selection by pressing S2 or S4.

PROGRAMS AND CONTROL UNIT

DW70.5

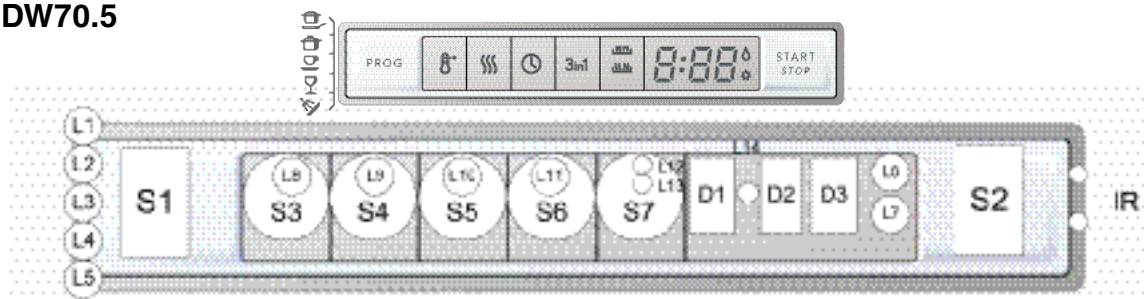

Panel type DW70.5, L = LED, S = Push button, D = Display

Variant settings

When the main power switch is switched on for the first time after replacing the control unit, the variant settings menu is displayed.

1. Press the Program button (S1) until the desired variant is selected:

The display shows the number 1 and L1 flashes:

Variant 1 = Time saver

The display shows the number 2 and L2 flashes:

Variant 2 = with Super rinse

The display shows the number 3 and L3 flashes:

Variant 3 = with Tab

The display shows the number 4 and L4 flashes:
Variant 4 = with Time program

2. Confirm your selection by pressing Start (S2). The machine detects the presence of a turbidity sensor, a pressure sensor and a spray arm diverter. The program returns to the main menu.

To return to the variant settings menu:

1. Turn off the main power switch (I/O)
2. Wait at least 5 seconds
3. Press and hold the Program and Start buttons (S1 and S2)
4. Switch on the main power switch (I/O)
5. Release the Program and Start buttons (S1 and S2). It takes a few seconds for the machine to detect that S1 and S2 are pressed. Proceed to step 6 within five seconds
6. Press Start (S2) three times in quick succession. L1, L2, L3 or L4 flashes on the display depending on the previous setting.
7. Use the Program button (S1) to select a variant
8. Confirm with the Start button (S2). The program automatically returns to the main menu.

Water hardness setting

Activating the settings menu: ①

1. Turn off the machine using the main power switch.
2. Press and hold START/STOP and Drying selector at the same time as you press the main power switch once. You have now activated the Softener setting menu.

START
STOP +))) + ①

3. Use the Program button to adjust the water hardness.

4. Press START/STOP to save the setting and exit the menu.

START
STOP

Total reset

Setting	Water hardness [°dH]
Display shows 0	0-5 (incl. machines without water softener)
Display shows: 1	6-8
Display shows: 2	9-11
Display shows: 3	12-14
Display shows: 4	15-19
Display shows: 5	20-24
Display shows: 6	25-29
Display shows: 7	30-39
Display shows: 8	40-49
Display shows: 9	50+

To reset the machine to its factory settings.

1. Turn off the main power switch (I/O)
2. Wait at least 5 seconds
3. Press and hold the Program button (S1)
4. Switch on the main power switch (I/O)
5. Release the Program button (S1).

The machine will reset various settings, although not water hardness, language, variant and intake volume. The machine detects the presence of a turbidity sensor, a pressure sensor, a humidity sensor and a spray arm diverter. The machine then automatically returns to the main menu. 23

DW70.C

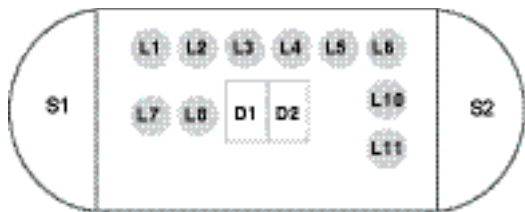

Panel type DW70.3, L = LED, S = Push button,

Water hardness setting

Activate settings menu. :

1. Turn off the machine using the main power switch.(I/O)
2. Wait for at least 5 seconds.
3. Press and hold the start button (S2)
4. Turn on the machine using the main power switch(I/O)
5. Release the button (S2)
6. Use the Program button (S1) to select the desired status

Setting: Water hardness [°dH]

(German water hardness scale)

Display: 0 0-5 (also applies to machines without water softener)

Display shows: 1 6-8

Display shows: 2 9-11

Display shows: 3 12-14

Display shows: 4 15-19

Display shows: 5 20-24

Display shows: 6 25-29

Display shows: 7 30-39

Display shows: 8 40-49

Display shows: 9 50+

Confirm your selection by pressing Start (S2). The program returns to the main menu.

Total reset

To reset the machine to its factory settings.

1. Turn off the main power switch (I/O)
2. Wait at least 5 seconds.
3. Press and hold the Program button (S1)
4. Switch off the main power switch (I/O)
5. Release the Program button (S1).

The machine will reset various settings, although not water hardness, water inlet volume and feel presence of turbidity, pressure sensor and Spray arm diverter and then automatically return to the main menu. Detects the presence of a pressure sensor.

PROGRAMS AND CONTROL UNIT

5.7. Service menu

Activating the service menu

DW70.1

1. Turn off the main power switch (I/O)
2. Wait at least 5 seconds
3. Press and hold the Program and Start buttons (S1 & S2)
4. Switch on the main power switch (I/O)
5. Release the Program and Start buttons (S1 & S2)
L7 flashes

Press S1 to activate the component test. These are activated in order after each button press:

1. Inlet valve and mixer valve (mixer valve open 1 second then inlet valve open, after next press of S1 both valves closed 1 second then only inlet valve open)
2. Salt water valve (salt and mixer valve only in machines with water softener)
3. Combi dispenser
4. Circulation pump
5. Circ. pump and element (max. 75°C)
6. Fan and Vax motor
7. Drain pump

Adjust water intake (done in service menu)

Press and hold the Program button (S1) for three seconds. The water intake can now be adjusted as described below

L1 unlit: Volume-controlled water intake (controlled by flow meter)

L1 lit: Time-controlled water intake

Confirm your selection by pressing Start (S2). The program returns to the main menu.

DW70.3

1. Turn off the main power switch (I/O)
2. Wait at least 5 seconds
3. Press and hold the Program and Start buttons (S1 and S2)
4. Switch on the main power switch (I/O)
5. Release the Program and Start buttons (S1 and S2)
L10 and L11 flash.

Most recent fault indicated by L1-L6.

Press S1 to activate the component test. These are activated in order after each button press:

1. Inlet valve and mixer valve (mixer valve open 1 second then inlet valve open, after next press of S1 both valves closed 1 second then only inlet valve open). L1 and L2 lit
2. Salt water valve (salt and mixer valve only in machines with water softener). L3 lit
3. Combi dispenser. L4 lit
4. Circulation pump. L5 lit
5. Circ. pump and element (max. 75°C). L6 lit
6. Fan and Vax motor. L1 and L2 lit
7. Drain pump. L1, L2 and L3 lit

Adjust water intake (done in service menu)

Press and hold the Program button (S1) for three seconds. The water intake can now be adjusted as described below

Press the Program button to step through:

L1-L6 unlit: Normal water intake volume

L1 lit: Water intake volume increases by 5 %

L2 lit: Water intake volume increases by 10 %

L3 lit: Time-controlled water intake

L4 lit: Water intake volume increases by 5% time-controlled

L5 lit: Water intake volume increases by 10% time-controlled

L6 lit: Water intake volume increases by 15% time-controlled

Confirm your selection by pressing Start (S2). The program returns to the main menu.

PROGRAMS AND CONTROL UNIT

DW70.4

1. Turn off the main power switch (S5)
2. Wait at least 5 seconds
3. Press and hold the Program and Start buttons (S1 and S2)
4. Switch on the main power switch (S5)
5. Release the Program and Start buttons (S1 & S2)

The service menu has four submenus:

1. Machine and fault information
 2. Component diagnostics
 3. Adjust water intake
 4. Adjust LCD contrast
- Press (S4) to browse between these menus
Press (S3) to enter the selected submenu
and (S4) to return

Machine and fault information displays:

(browse with S3)

1. Date code (year/week) of control unit
2. Software version
3. Most recent fault
4. Second most recent fault (other than most recent)
5. Third most recent fault (other than two most recent)

Activating component diagnostics: (browse with S3)

1. Inlet valve and mixer valve (mixer valve open 1 second then inlet valve open, after next press both valves closed 1 second then only inlet valve open (display shows water volume pulses from the flow sensor which is situated in the lower part of the air break.
2. Salt water valve (salt and mixer valve only in machines with water softener)
3. Detergent and rinse aid dispenser
4. Circulation pump (display shows turbidity (dirt sensor) according to chart)
5. Heater and circulation pump (max. 75 °C) (display shows temperature, see Table)
6. Fan (display shows humidity sensor reading)
7. Drain pump (display shows pressure sensor reading: according to chart)

Adjust water intake (browse with S3)

Display 0: Normal water intake volume

Display +5 %: Water intake volume increases by 5 %

Display +10%: Water intake volume increases by 10%

Display +15 %: Water intake volume increases by 15 %

Display Time: Time-controlled water intake

Display +5 %: Water intake volume increases by 5%

Display +10%: Water intake volume increases by 10%

Display +15 %: Water intake volume increases by 15%

Adjust LCD contrast (browse with S3)

LCD contrast = 0, +1, +2, -1.

Press Start (S2) to store the water intake volume and LCD contrast settings.

The program returns to the main menu.

VDC	Display
0	0
0.2	10
0.4	20
0.6	31
0.8	41
1.0	51
1.2	61
1.4	71
1.6	82
1.8	92
2.0	102
2.2	112
2.4	122
2.6	133
2.8	143
3.0	153
3.2	163
3.4	173
3.6	184
3.8	194
4.0	204
4.2	214
4.4	224
4.6	235
4.8	245
5.0	255

The table shows the voltage and corresponding display code DW70.4

PROGRAMS AND CONTROL UNIT

DW70.5

1. Turn off the main power switch (I/O).
2. Wait at least 5 seconds.
3. Press and hold the Program and Start buttons (S1 and S2).
4. Switch on the main power switch (I/O).
5. Release the Program and Start buttons (S1 and S2) when the LEDs have lit.

The most recent fault is shown in display D2 and D3. Error messages are erased by a total reset.

Press S1 to activate the component test. These are activated in order after each button press and are shown in display D3.

1. Inlet valve and mixer valve (mixer valve open 1 second) then inlet valve open.
2. Only inlet valve open.
3. Salt water valve (salt and mixer valve only in machines with water softener)
4. Combi dispenser
5. Circulation pump
6. Circ. pump and element (max. 75°C)
7. Fan and Vax motor
8. Drain pump

Adjust water intake (in service menu)

Press the Program button (S1) for 3 seconds to activate the menu for setting the water intake. Then use the Program button (S1) to step through.

The display shows:

- P:0 = Normal water intake volume
- P:5 = Water intake volume increases by 5%
- P:10 = Water intake volume increases by 10%
- P:15 = Water intake volume increases by 15%
- T:0 = Normal water intake volume
- T:5 = Water intake volume increases by 5%
- T:10 = Water intake volume increases by 10%
- T:15 = Water intake volume increases by 15%

P = water intake controlled by flow meter

T = water intake time-controlled

Confirm selection by pressing Start (S2). The program returns to the main menu.

DW70.C

1. Turn off the main power switch (I/O).
2. Wait at least 5 seconds.
3. Press and hold the Program and Start buttons (S1 and S2).
4. Switch on the main power switch (I/O).
5. Release the Program and Start buttons (S1 and S2).

The display lights up in five seconds.

Fault indications

Latest occurred fault indicates F1, F2 and so on, on the display

Component test

Press S1 to activate the component test and step through the following components:

1. Inlet valve
2. Salt water valve (only in machines with water softener)
3. Detergent and rinse aid dispenser
4. Circulation pump
5. Heater and circulation pump (Max 85°C)
6. Fläkt
7. Avloppspump

Adjust water intake

Hold the program button until "1" in the display extinguished. Now, the water intake is adjustable according to below:

Press the program button and step through:

The display shows:

- 0: Normal water intake volume
- 1: Water intake volume increases by 5%
- 2: Water intake volume increases by 10%
- 3: Water intake volume increases by 15%
- 4: Time-controlled water intake
- 5: Time-controlled water intake increases by 5%
- 6: Time-controlled water intake increases by 10%
- 7: Time-controlled water intake increases by 15%

Confirm selection by pressing Start (S2).

The program returns to the main menu.

TROUBLESHOOTING

6. Troubleshooting

6.1 Dishwashing results

Check the following points if the dishes are not clean (always begin by checking any fault codes and the most recent fault indication in the service menu):

- That the customer is using the right dishwashing program.
- If heavily soiled dishes are being loaded, such as pots or oven dishes, choose a heavier program.
- Check that the customer is using a suitable dishwashing detergent, preferably one with proven good results.
- Detergent is a perishable product. Check that the detergent is not too old and that the customer is using the right amount. **Most importantly not too much detergent.**
- For machines with a water softener, dose as for soft water.
- Check that the customer is loading the machine correctly.
- Check that no dishes are preventing the spray arms from rotating and that the holes are not clogged.
- Check that the machine has the right water level (see page 29).
- Check that the gauge block on the left side of the bottom drain by the drain pump is in place.
- Check that the machine heats to the right temperature.

Film or marks on dishes after washing

- Is the water softener cover properly tightened?
- Is the rinse aid dispenser correctly adjusted?
- Is the water softener correctly adjusted?
- Is there any salt in the salt compartment?
- Is the right type of salt being used?

6.2 Common faults

If the dishwasher does not work, you should first check whether this is due to a simple fault, something that the customer can rectify. Use the following questions to troubleshoot the machine.

The machine will not start

- Has a fuse blown?
- Is the machine powered?
- Is the door properly closed?
- Is the water supply turned on?

If the answer to any of the above questions is “YES” and the machine seems to lack power, first check that there is power at the main power switch and the control unit. Replace any faulty components.

Water remaining in the machine

- Is the drain hose blocked? Check the connection to the household drain.
- Is the drain hose bent?
- Are the filters blocked?
- Is the drain pump blocked?
- Is the gauge block on the left side of the bottom drain by the drain pump incorrectly fitted?

If the fault cannot be found with the help of this chapter, open the service menu and perform an function test on all components.

TROUBLESHOOTING

6.3 Water level DW70

When servicing a DW70 dishwasher it is important to check the water level in the machine.

This is particularly important when programming the time-controlled water intake. Too low a water level can cause poor dishwashing results.

Always allow the machine to take in and drain the water a few times before checking the level.

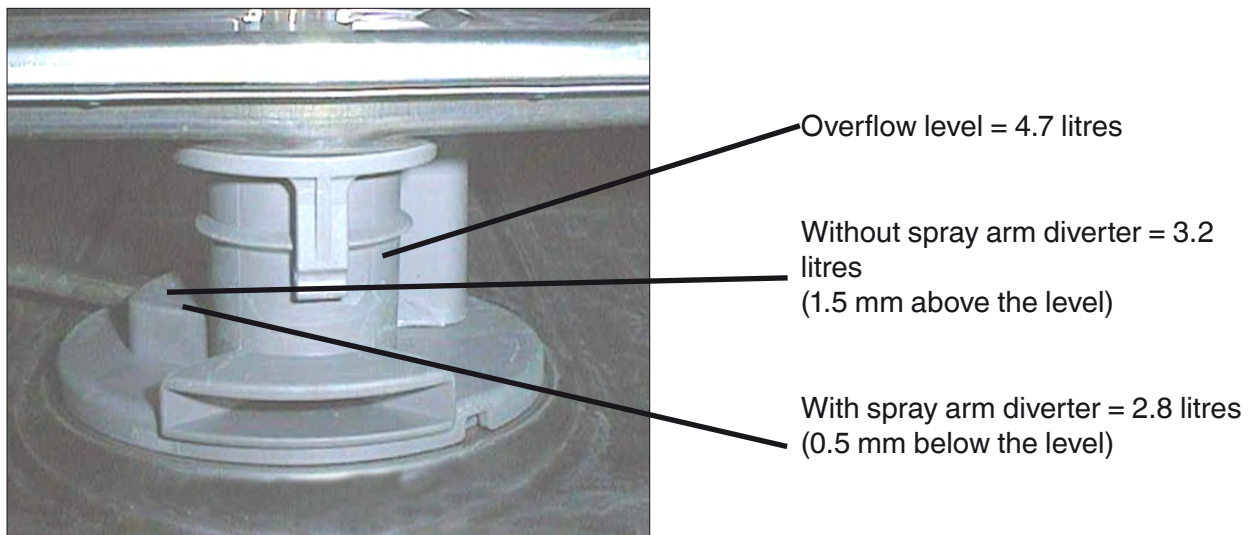

Figure: Check the level against the lower spray arm hub

In the event of too low a water level, the filter in the inlet valve must always be checked and rinsed clean of any dirt. The inlet hose with a 3/4" connection at both ends has a filter in the connector outside the machine that must also be checked and rinsed clean of any dirt.

TROUBLESHOOTING

6.4 Fault indication

DW70.1

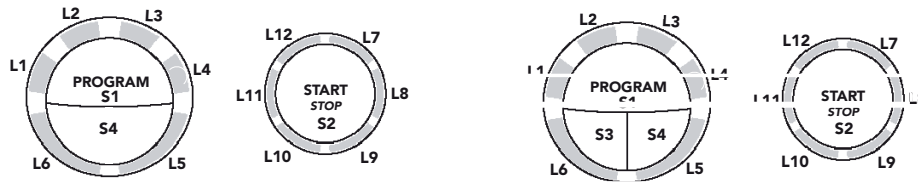

DW70.3

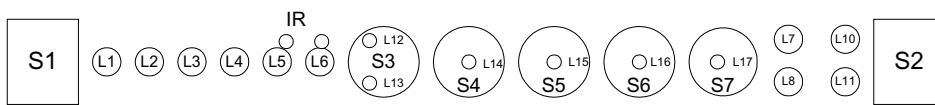

DW70.4



DW70.5

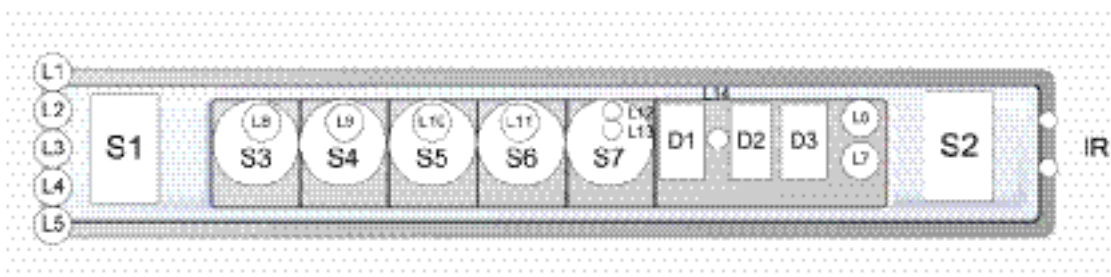

DW70.C

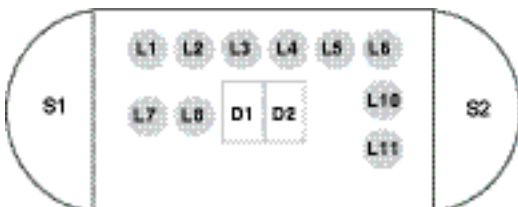

L - LED, S - Push button, F - Fault code or plain text on display, D - Display

The door is open

- 70.1 Lit program progress lamps flash
- 70.3 L10 flashes
- 70.4 "Close door"
- 70.5 The display shows ≡≡≡
- 70.C L10 flashes

Clean filter: (only DW70.4)

"Clean filter"
Shown automatically after every 300 cycles and is not a fault indication. This message is a reminder to the user to check the filters and clean them if necessary. The message disappears the next time a button is pressed.

TROUBLESHOOTING

6.4 Fault codes

NB: Some DW70.3 and DW70.4 models may have a status lamp that always flashes together with the current fault indicator. If the customer has activated the sound option an audible signal is also heard when a fault is indicated.

Temperature stop fault (DW70.1 no indication)

- 70.3 L1 flashes
- 70.4 "Temp. stop fault"
- 70.5 Fault code "F1"
- 70.C Fault code "F2"

Temperature increase less than 5°C in ten minutes. Program continues with the process. Only indicated in service menu.

Check: Element, thermistor, water level, circulation pump, control unit and cables.

Overfilling

- 70.1 L2 flashes
- 70.3 L2 flashes
- 70.4 "Overfilling"
- 70.5 Fault code "F2"
- 70.C Fault code "F2"

Too much water in the machine (pressure sensor) or float activated. If the water has not been emptied within 60 seconds, the program stops (drain pump activated).

Check: Drain pump (blocked hose), flow meter, inlet valve, leaks and cables.

Thermistor fault (DW70.1 no indication)

- 70.3 L3 flashes
- 70.4 "Thermistor fault"
- 70.5 Fault code "F3"
- 70.C Fault code "F3"

Stopped or >80 °C. Program continues with the process. Only indicated in service menu.

Check: Thermistor and control unit.

Water intake fault (DW70.1 no indication)

- 70.3 L4 flashes
- 70.4 "Water inlet fault"
- 70.5 Fault code "F4"
- 70.C Fault code "F4"

< 80 pulses within 60 seconds or correct number of pulses not achieved within 255 seconds. Program stops.

Check: Water inlet, flow meter, inlet valve and cables.

Leaking valve

- 70.1 L5 flashes
- 70.3 L5 flashes
- 70.4 "Leaking valve"
- 70.5 Fault code "F5"
- 70.C Fault code "F5"

Water intake detected when inlet valve deactivated. Any current program stopped (drain pump activated).

Check: Leak through inlet valve and flow meter.

Pressure sensor fault (DW70.1 no indication)

- 70.3 L6 flashes
- 70.4 "Pressure sensor fault"
- 70.5 Fault code "F6"
- 70.C Fault code "F6"

Output signal > 4.8 V. The program continues. Only indicated in service menu.

Check: Pressure sensor, control unit and cables.

Drain fault (DW70.1 no indication)

- 70.3 L1 and L2 flash
- 70.4 "Drain error"
- 70.5 Fault code "F7"
- 70.C Fault code "F7"

Water not drained after 120 seconds draining. Program stops.

Check: Drain pump, hoses, drain hose fittings, control unit and cables. Also check whether filter is blocked.

Turbidity sensor fault (DW70.1 no indication)

- 70.3 L1 and L5 flash
- 70.4 "Turbidity sensor fault"
- 70.5 Fault code "FA"
- 70.C Fault code "FA"

Only indicated in service menu. The machine assumes high turbidity in case of "uncertainty" in the auto program.

Check: Water quality, filters, turbidity sensor and drain system.

Spray arm diverter fault (DW70.1 no indication)

- 70.3 L1 and L6 flash
- 70.4 "Diverter fault"
- 70.5 Fault code "FB"
- 70.C Fault code "FB"

Position switch always closed or open. The program continues. Only indicated in service menu.

Check: Spray arm diverter (functioning gearbox, switches and cables).

Humidity sensor fault (only DW70.4)

"Humidity sensor fault" (only in service menu)

Check: Humidity sensor, cables, fan, damper and Vax motor.

TOOLS

7.1 Tools

The following tools are needed to service the DW70 dishwasher:

Torx

- T25
- T20
- T10

Ring spanner

- 10 mm
- 17 mm

Socket screwdriver

- 10 mm

7.2 Special tools

- 8801339 Universal tool, dishwasher
- 7281370 Hose clamp pliers, Oetiker

