

This Base Manual covers all  
Commercial Combination/Convection  
Microwave Ovens with 230 V, 60 Hz.  
Refer to individual Technical Sheet  
for information on specific models.

# Service

## Commercial Combination/ Convection Microwave Oven with 230 V, 60 Hz

Service Manual for  
Amana®  
MenuMaster®

This manual is to be used by qualified appliance technicians only. Amana does not assume any responsibility for property damage or personal injury for improper service procedures done by an unqualified person.

**Amana**  
Raytheon Appliances

RS2230002  
Revision 0  
October 1996

# Important Product Information



## WARNING

Precautions to be observed before and during servicing to avoid possible exposure to excessive microwave energy, or electrical shock disconnect power to oven.

Do not operate or allow oven to be operated with door open.

Make the following safety checks on all ovens to be serviced before activating the magnetron or other microwave source, and make repairs as necessary:

- Interlock operation
- Proper door closing
- Seal and sealing surfaces (arcing, wear, and other damage)
- Damage to or loosening of hinges and latches
- Evidence of dropping or abuse

Before turning on microwave power for any service test or inspection within the microwave generating compartments, check the magnetron, waveguide or transmission line, and cavity for proper alignment, integrity, and connections.

Any defective or misadjusted components in the interlock, monitor, door seal, and microwave generation and transmission systems shall be repaired, replaced or adjusted by procedures described in this manual before oven is released to the consumer.

Check microwave leakage to verify compliance with the federal performance standard should be performed on each oven prior to release to the consumer.

## WIRING

Good service practice is to never route wiring over terminals and/or sharp edges. This applies to any wiring without regard to the circuit voltage. Wire insulation material and thickness is designed and regulated for electrical spacing purpose only, but cannot always be relied upon because of possible cuts and/or abrasions, which can occur during servicing.



## WARNING

To avoid risk of electrical shock, injury, or death, make sure these grounding instructions are followed.

## Grounding Instructions



## WARNING

Do not remove grounding prong when installing grounded appliance in a home or business that does not have three wire grounding receptacle, under no condition is grounding prong to be cut off or removed. It is the personal responsibility of the consumer to contact a qualified electrician and have properly grounded three prong wall receptacle installed in accordance with appropriate electrical codes

Should a two prong adapter plug be required temporarily it is the personal responsibility of the consumer to have it replaced with properly grounded three prong receptacle or the two prong adapter properly grounded by a qualified electrician in accordance with appropriate electrical codes.

## Servicing of Grounded Products

The standard accepted color coding for grounding wires is GREEN or GREEN WITH YELLOW STRIPE. These ground leads are NOT to be used as current carrying conductors. It is extremely important that the technician replace any and all grounds prior to completion of the service call. Under no condition should ground wire be left off causing a potential hazard to technicians and consumer.

# Table of Contents

Important Product Information .....	2	Operating Instructions .....	14
Important Information .....	5	Preheat Entry .....	14
Important Safety Information .....	6	Operating Preheat Function .....	14
Product Information .....	8	Reset or Cancel .....	14
Strirrer Blade .....	8	Summary of Preheat Function .....	14
Blower/Fan Assembly .....	8	Programmable Menu Entry .....	15
Door Interlock and Monitoring Switch .....	8	Operating Programmable Menu Items .....	15
Stirrer Cover .....	8	Pause or Cancel .....	15
Auto Transformer .....	8	Summary of Programmable Menu Items .....	15
Transformer .....	8	Manual Microwave Entry .....	16
High Voltage Capacitor .....	8	Operating Microwave Function .....	16
High Voltage Diode (Rectifier) .....	8	Pause or Cancel .....	16
Magnetron .....	8	Summary of Microwave Function .....	16
Thermal Protectors .....	8	Manual Convection Entry .....	17
Touch Panels .....	8	Operating Convection Function .....	17
Triacs .....	8	Pause or Cancel .....	17
RTD (Resistive Thermal Device) .....	8	Summary of Convection Function .....	17
Heating Elements .....	8	Manual Combination Entry .....	18
Installation .....	9	Operating Combination Function .....	18
Unpacking Oven .....	9	Pause or Cancel .....	18
Oven Placement .....	9	Summary of Combination Function .....	18
Radio Interference .....	9	Programming Instructions .....	19
Grounding Instructions .....	9	Programming Pads (1-8) .....	19
Care and Cleaning .....	10	Programming Mode .....	19
Recommended Maintenance Schedule .....	10	Summary of Programming Mode .....	19
Recommended Cleaning Schedule .....	10	Programming User Options .....	20
General Cleaning .....	10	Setting User Options .....	20
Cleaners .....	10	Summary of Setting User Options .....	20
Oven Racks and Rack Hooks .....	10	User Options for CMA2230, CCMA22300, MM2230C, and CMM2230C Models .....	21
Air Filter .....	10	Component Testing Procedures .....	22
Discharge Air Vents .....	10	Test Modes .....	25
Oven Operation .....	11	Power Test .....	25
Fan .....	11	Temperature Chart .....	25
Ready Mode .....	11	Oven Temperature Test .....	26
Standby Mode .....	11	Oven Temperature Calibration .....	26
Preheat .....	11	Radiation Leakage Testing .....	27
Cooking .....	11	Equipment .....	27
Programmable Menus .....	11	Procedure For Measuring Radiation Leakage .....	27
Programmable Pads .....	11	Measurement With the Outer Panel Removed .....	27
Microwave .....	11	Measurement With a Fully Assembled Oven .....	27
Convection .....	11	Record Keeping and	
Combination .....	11	Notification After Measurement .....	27
User Options .....	11	Display Diagnostics .....	28
Cooking Displays .....	12	Service Codes .....	28
Default Cooking Time .....	12	Service Test .....	29
Default Preheat Temperature .....	12	Troubleshooting .....	30
Default Cooking Temperature .....	12	Power up .....	30
Preheat/Convection Indicator .....	12	Ready Condition .....	30
Microwave Indicator .....	12	Microwave Condition .....	31
Flashing Items .....	12	Preheat Condition .....	32
Control Pads .....	13	Convection .....	33

# Table of Contents

Disassembly .....	34
Door Handle .....	34
Door Glass Retainer/Inner Window Assembly ...	34
Outer Door .....	34
Inner Door Assembly .....	34
Choke Cover Removal .....	34
Hinge .....	35
Outer Case .....	35
Back Panel .....	35
Stirrer Cover .....	35
RTD (Resistance Thermal Device) .....	35
Top Touch Panel Assembly .....	36
Side Touch Panel Assembly .....	36
Low Voltage Circuit Board .....	36
High Voltage Circuit Board .....	36
Interlock Switch Module .....	37
Adjustment .....	37
Display Module .....	37
Magnetron .....	37
Magnetron, Control, and Fan Thermal Cutout (TCO) .....	37
Triacs .....	37
Microwave Blower Wheel and Motor .....	38
Fan Blade .....	38
Auto Transformer .....	38
Transformer .....	38
Capacitor .....	38
Heater Box .....	38
Calrods .....	38
Convection Fan and Motor .....	39
Fuse .....	39
Power Cord .....	39
Light Socket .....	39
Replacing Oven Light Bulb .....	39
Component Location .....	40

# Important Information

Pride and workmanship go into every product to provide our customers with quality products. It is possible, however, that during its lifetime a product may require service. Products should be serviced only by a qualified service technician who is familiar with the safety procedures required in the repair and who is equipped with the proper tools, parts, testing instruments and the appropriate service manual. **REVIEW ALL SERVICE INFORMATION IN THE APPROPRIATE SERVICE MANUAL BEFORE BEGINNING REPAIRS.**

## Important Notices for Consumers and Servicers



### WARNING

To avoid risk of serious injury or death, repairs should not be attempted by an unauthorized person, dangerous conditions (such as exposure to electrical shock) may result.



### CAUTION

Amana will not be responsible for any injury or property damage from improper service procedures. If performing service on your own product, assume responsibility for any personal injury or property damage which may result.

To locate an authorized servicer, please consult your telephone book or the dealer from whom you purchased this product. For further assistance, please contact:

CONSUMER AFFAIRS DEPT.  
AMANA REFRIGERATION, INC.  
AMANA, IOWA 52204

**OR  
CALL**

1-319-622-5511  
and ask for  
Consumer Affairs

If outside the United States contact:

AMANA  
ATTN: CONSUMER AFFAIRS DEPT  
AMANA, IOWA 52204, USA  
Telephone: (319) 622-5511  
Facsimile: (319) 622-2180  
TELEX: 4330076 AMANA  
CABLE: "AMANA", AMANA, IOWA, USA

## Recognize Safety Symbols, Words, and Labels



### DANGER

**DANGER** - Immediate hazards which **WILL** result in severe personal injury or death.



### WARNING

**WARNING** - Hazards or unsafe practices which **COULD** result in severe personal injury or death.



### CAUTION

**CAUTION** - Hazards or unsafe practices which **COULD** result in minor personal injury or product or property damage.

# Important Safety Information



## CAUTION

Do not become exposed to radiation from the microwave generator or other parts conducting microwave energy.

Basic design of this microwave oven makes it an inherently safe device to both use and service. However, there are some precautions which should be followed when servicing microwave oven to maintain this safety. These are as follows:

1. Always operate unit from an adequately grounded outlet. Do not operate on a two-wire extension cord.
2. Before servicing unit (if unit is operable) perform microwave leakage test.
3. Oven should never be operated if door does not fit properly against seal, hinge/hinge bearings are damaged or broken; choke is damaged, (pieces missing, etc.); or any other visible damage can be noted. Check choke area to ensure that this area is clean and free of all foreign matter. If any above problems occur take the following steps:
  - Tell the user not to operate the oven.
  - Contact Amana immediately.
4. If oven operates with door open and produces microwave energy, take the following steps:
  - Tell the user not to operate the oven.
  - Contact Amana immediately.
5. Always have oven disconnected when outer case is removed except when making "live" tests called for in the service manual. Do not reach into equipment area while unit is energized. Make all connections for the test and check them for tightness before plugging cord into outlet.
6. Always ground capacitors on magnetron filter box and H.V. capacitor with an insulated-handle screwdriver before working in high voltage area of equipment compartment. Some types of failures will leave a charge in capacitors and the discharge could cause a reflex action which could make you injure yourself.
7. In the area of the transformer, capacitor, diode, and magnetron there is HIGH VOLTAGE. When unit is operating, keep area clean and free of anything which could possibly cause an arc or ground, etc.
8. **DO NOT** for any reason defeat interlock switches, there is no valid reason for this action at any time; nor will it be condoned by Amana.
9. Microwave oven should never be operated with:
  - Any components removed and/or bypassed
  - Any of the safety interlocks are found to be defective
  - Any of the seal surfaces are defective, missing, or damaged
10. To ensure that unit does not emit excessive microwave leakage and to meet Department of Health and Human Services guidelines check oven for microwave leakage using Narda Model 8100, 8200, Holaday HI1500, HI1501, or Simpson 380M leakage monitor as outlined in instructions. Maximum leakage level allowed is 4mw/cm<sup>2</sup>.
11. If servicer encounters an emission reading over 4mw/cm<sup>2</sup>, servicer is to cease repair and contact Amana Service Department immediately for further direction. Amana will contact the proper Government Agency upon verification of test results.
12. Install or locate this equipment **ONLY** in accordance with the installation instructions in this manual.
13. Some products such as whole eggs and sealed containers – for example, closed glass jars – may explode and **SHOULD NOT** be **HEATED** in this equipment.
14. Use this equipment **ONLY** for its intended use as described in this manual. Do not use corrosive chemicals or vapors in this equipment. This type of equipment is specifically designed to heat or cook. It is not designed for industrial or laboratory use.
15. As with any equipment, **CLOSE SUPERVISION** is necessary when used by **CHILDREN**.
16. **DO NOT** operate this equipment if it has a damaged cord or plug, if it is not working properly, or if it has been damaged or dropped.
17. This equipment, including power cord, must be serviced **ONLY** by qualified service personnel. Special tools are required to service equipment. Contact nearest authorized service facility for examination, repair, or adjustment.
18. **DO NOT** cover or block any openings on the equipment.
19. **DO NOT** store this equipment outdoors. **DO NOT** use this product near water – for example, near a kitchen sink, in a wet basement, or near a swimming pool, and the like.
20. **DO NOT** immerse cord or plug in water.
21. Keep cord **AWAY** from **HEATED** surfaces.
22. **DO NOT** let cord hang over edge of table or counter.

# Important Safety Information

## CAUTION

To avoid risk of personal injury or death of fire in the oven cavity:

- **DO NOT** overcook food. Carefully attend equipment if paper, plastic, or other combustible materials are placed inside the equipment to facilitate cooking.
- Remove wire twist-ties from paper or plastic bags before placing bag in equipment.
- **KEEP equipment DOOR CLOSED**, turn equipment off, and disconnect the power cord, or shut off power at the fuse or circuit breaker panel, if materials inside the equipment should ignite. Fire may spread if door is opened.
- **DO NOT** use the cavity for storage purposes. **DO NOT** leave paper products, cooking utensils, or food in the cavity when not in use.

## CAUTION

To avoid personal injury or property damage, observe the following:

1. Briskly stir or pour liquids before heating with microwave energy to prevent spontaneous boiling or eruption. Do not overheat. If air is not mixed into a liquid, liquid can erupt in equipment or after removal from equipment.
2. Do not deep fat fry in equipment. Fat could overheat and be hazardous to handle.
3. Do not cook or reheat eggs in shell or with an unbroken yolk using microwave energy. Pressure may build up and erupt. Pierce yolk with fork or knife before cooking.
4. Pierce skin of potatoes, tomatoes, and similar foods before cooking with microwave energy. When skin is pierced, steam escapes evenly.
5. Pop popcorn in microwave mode only. If equipment is preheated or hot, allow equipment to cool before popping popcorn or bag may ignite.
7. Do not use regular cooking thermometers in equipment when cooking in microwave or combination mode. Most cooking thermometers contain mercury and may cause an electrical arc, malfunction, or damage to equipment.
8. Do not heat baby bottles in equipment.
9. Do not use metal utensils in equipment except when recommended by microwave food manufacturers or recipe requires metal utensils in convection or combination mode. Heat food in containers made of glass or china if possible.
10. Never use paper, plastic, or other combustible materials that are not intended for cooking. If equipment temperature is high, material may ignite.
12. Do not use paper towels which contain nylon or other synthetic fibers. Heated synthetics could melt and cause paper to ignite.
13. Do not heat sealed containers or plastic bags in equipment. Food or liquid could expand quickly and cause container or bag to break. Pierce or open container or bag before heating.
14. Racks, utensils, and equipment surfaces may become hot during or after use. Use utensils or protective clothing, like pan grips or dry oven mitts, when necessary to avoid burns.
15. Do not use rack position if rack hook breaks. Replace broken hooks immediately.
16. Do not unplug equipment immediately after use. Internal fan must cool equipment to avoid damage of electrical components.

# Product Information

## Stirrer Blade

Distributes microwave energy throughout the cavity.

## Blower/Fan Assembly

Circulates cooling air throughout the convection or microwave oven compartment and cavity.

## Stirrer Cover

Covers and protects the stirrer blade assembly.

## Door Interlock and Monitoring Switch

**NOTE:** When the line fuse is blown the Interlock Switch Module must be replaced.

Interlock switch (module) mounts behind oven cavity front bulkhead. It is actuated by door hook and guide attached to the door.

Monitoring switch (contacts 7 and 8) is actuated by the door guide.

The primary interlock switch (contacts 2 and 3) is actuated by the door hook.

The primary interlock switch is in series with the interlock monitoring switch in the monitor circuit.

If a malfunction occurs in the primary interlock when door opens, current will flow through the monitor switch causing the oven fuse to open.

If a faulty door interlock switch has allowed current through the monitor switch, the switch module must be replaced (see interlock switch testing) before replacing fuse.



## DANGER

To avoid severe personal injury or death avoid contacting any high voltage parts. The capacitors are at high voltage (4000 volt) potential and it is extremely important that they be grounded before handling.

## Auto Transformer

Auto transformer in this unit provides a voltage step down from 230 V to 208 V for convection motor.

## Transformer High Voltage

High voltage transformer is used in this unit, which supplies high voltage A.C. for operation of the magnetron tube.

## High Voltage Capacitor

Doubles the A.C. output voltage from the high voltage transformer.

## High Voltage Diode (Rectifier)

Is connected at the output side of the high voltage capacitor. It changes voltage from A.C. to D.C. It passes current in one direction and blocks it in the other. Also called a rectifier.

## Magnetron

With filament voltage and high D.C. voltage from the output of the H.V. capacitor, diode junction the magnetron will put out an electromagnetic radio frequency of 2450 MHz to heat the food load in the oven.

## Thermal Protectors

At a predetermined temperature the thermal cut-outs will open or close. The oven will indicate an error code in the display, initiate cooling fan operation, or prevent the generation of microwave energy.

- Magnetron thermal cut-out is mounted directly on the body of the magnetron
- Fan thermal cut-out is mounted directly on the exhaust duct
- Control thermal cut-out is mounted directly on the heater box

## Touch Panels

Allows consumer operation and programming of oven.

## Triacs

Triacs are controlled by high voltage and low voltage circuit boards. Triacs control one side of the power line going to the high voltage power transformer and calrods.

- Microwave triacs, heating elements A, and B triacs are mounted inside oven chassis behind oven cavity front bulkhead

## RTD (Resistance Thermal Device)

Maintains proper temperature inside oven cavity.

## Heating Elements

Heating elements are used to produce convection heat.



# Installation

## Unpacking Oven

- Remove packing and printed material from oven cavity.
- Report any dents or breakage to source of purchase immediately.
- Inspect oven for damage such as dents in door or inside oven cavity.

## Oven Placement

- Do not install oven over or under another microwave, convection, or combination oven.
- Do not install oven next to or above source of heat, such as pizza oven or deep fat fryer. Excessive heat may cause oven to operate improperly and shorten life of electrical parts.
- Install combination oven so oven bottom is at least 91.5 centimeters / 3 feet above floor.
- Allow air flow around oven leaving at least 3.18 centimeters / 1 ¼ inch between air discharge on back of oven and back wall. Lift handle on back of oven ensures 3.18 centimeters / 1 ¼ inch spacing. Restricted air flow may cause oven to operate improperly and shorten life of electrical parts.
- Install according to all local building codes and ordinances.

## Radio Interference

Microwave or combination mode operation may cause interference to radio, television, or similar equipment. Reduce or eliminate interference by doing the following:

- Clean door and sealing surfaces of oven according to instructions in "Care and Cleaning" section.
- Place radio, television, etc. as far as possible from oven.
- Use properly installed antenna on radio, television, etc. to obtain stronger signal reception.

## Grounding Instructions

**NOTE:** Do not under any circumstances cut or remove grounding prong from the plug or bend power prongs to fit receptacle other than one shown for your equipment. Such abuse of the plug can result in electrical shock or overheating.

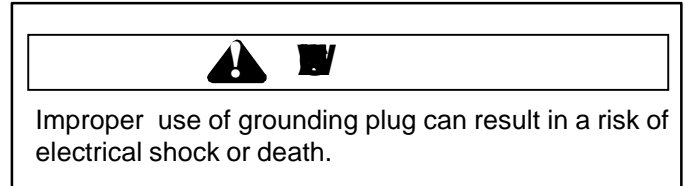

This equipment **MUST** be grounded. In the event of an electrical short circuit, grounding reduces risk of electric shock by providing an escape wire for electric current. This oven is equipped with a cord having grounding wire with a grounding plug. Plug must be plugged into an outlet that is properly installed and grounded. **DO NOT** use a two-prong adapter.

Consult a qualified electrician or servicer if grounding instructions are not completely understood, or if doubt exists as to whether the equipment is properly grounded.

Do not use an extension cord. If product power cord is too short, have a qualified electrician install an appropriate receptacle. This equipment should be plugged into a separate 60 Hz circuit with the appropriate electrical rating as shown in the drawings. When an oven is on a circuit with other equipment, an increase in cooking times may be required and fuses can be blown.

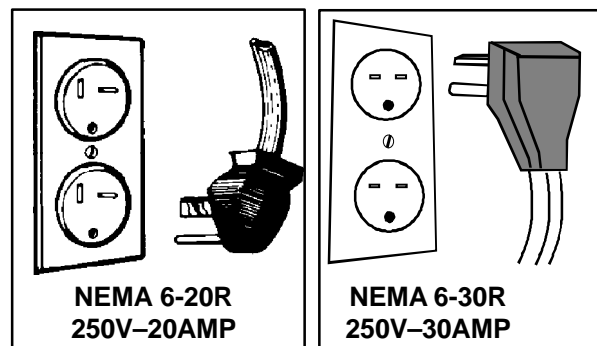

U.S. Model

Canadian Model

**Both U.S. and Canadian models require  
230 V 60 Hz power supply only.**

# Care and Cleaning

Clean oven frequently to maximize oven life, performance, and efficiency. A dirty oven cooks inefficiently because moisture, spills, and grease absorb convection and microwave energy.



## WARNING

To avoid electrical shock which can cause severe personal injury or death, disconnect power to appliance before cleaning.



## CAUTION

To prevent personal injury, handle utensils, racks, and door with care. Utensils, racks, and door may become hot during operation.

## Recommended Maintenance Schedule

Schedule Maintenance Cleaning (**Not Covered Under Warranty**)

- Contact an authorized servicer to remove and clean heater box.
- Schedule appointment every 6 months or when heavy grease buildup is apparent on back of oven cavity.

## Recommended Cleaning Schedule

### Schedule Several Daily Cleanings

- Clean interior, exterior, door, and racks according to Cleaning Oven Exterior instructions.
- If possible, clean spills immediately.
- Wipe dry after cleaning.

### Clean After Use

- Remove oven racks and rack hooks, and clean according to Oven Racks and Rack Hooks instructions.
- Clean exterior according to Cleaning Oven Exterior instructions.
- Clean oven cavity according to Cleaning Oven Cavity instructions.
- Wipe dry after cleaning.

## Cleaning Oven Exterior

Clean door and other exterior surfaces with a clean cloth, sponge, or nylon pad, and mild detergent diluted in warm water. Use commercial degreasers if heavily soiled.

- Do not use harsh or abrasive cleaners, or cleaners containing ammonia.
- Do not use water pressure type cleaning systems.
- Remove excess water from cloth before wiping oven.

## Cleaning Oven Cavity

Remove racks and rack hooks for best results. Clean oven cavity with oven and grill cleaner. Repeat cleaning several times if necessary. Wipe interior with damp, clean cloth or sponge thoroughly and dry after cleaning.

- Spray on damp cloth or sponge before applying to oven surfaces. If cleaners are sprayed into oven cavity, cleaner can become trapped behind rear wall and create unpleasant odor..
- Wear long rubber gloves when cleaning equipment.
- Follow manufacturer's instructions on use of cleaners.
- Do not use knife, metal utensil, or abrasive cleaning pad to remove baked on material.

## Oven Racks and Rack Hooks

Clean oven racks and rack hooks with detergent diluted in warm water or in dishwasher. Scrub with soft nylon pad to remove baked on material. Do not soak rack hooks for an extended period of time.

**NOTE:** If oven rack hook breaks, do not use rack position. Replace broken oven rack hook immediately.

## Air Filter

Air filter is located directly below oven door.

1. Remove air filter by removing filter retaining screws, located on outside edges of filter. Remove screws with fingers.
2. Wash filter with mild detergent diluted in warm water. Rinse and dry thoroughly.
3. Replace filter by reversing step 1.

**NOTE:** Clean air filter regularly to prevent overheating, which may damage oven.

## Discharge Air Vents

Check for a buildup of cooking vapors along discharge louvers in back of oven. Clean air vent with damp cloth to ensure proper airflow. Dry thoroughly.

# Oven Operation

## Fan

During microwave or convection cooking fan operates. Fan may come on at any time to cool internal oven components.

## Ready Mode

Oven display shows "READY" to indicate ready mode. If oven shows "STANDBY", pressing *ON/STANDBY* pad sets oven to ready mode. Once in ready mode, "R" in "READY" flashes for 2 minutes. While "R" flashes, pads are active. When "R" stops flashing, pads are not active. Oven door must be opened and closed to reactivate pads.

## Standby Mode

Oven shows "STANDBY" in display to indicate standby mode. If oven is in ready mode, pressing *ON/STANDBY* pad resets oven to standby mode. In standby mode, pads are inactive. Press *STANDBY* pad at end of day to disable pads.

## Preheat

Preheat oven before cooking with convection or combination mode for best results. Preheat temperatures range from 70°C/150°F to 250°C/475°F in increments of 10°C/25°F.

When oven heats to reach preheat temperature, oven display shows "WARMUP" with "W" flashing. While "W" flashes, pads are active. After 2 minutes, "W" stops flashing and pads become inactive. Oven door must be opened and closed, or preheat temperature reached to reactivate pads.

Oven maintains preheat temperature for 2 consecutive hours. If door is opened or pad is pressed during preheat cycle, oven resets 2 hour preheat timer. Oven resets to ready mode after 2 hours if not used.

## Cooking

Choose programmable menus (A, B, or C) or manual cooking functions (MICROWAVE, CONVECTION, or COMBINATION). Programmable menus and manual cooking functions have up to 4 cooking stages.

Set time, temperature, and/or microwave power level after manual cooking function is selected. If manual cooking function is selected and *START* pad pushed, oven cooks according to default time, temperature, and microwave power level. See "Cooking Displays" section for explanation of default settings.

## Programmable Menus

Oven has 3 programmable menus (A, B, and C). Each menu contains 8 programmable pads. Oven cooks according to how each pad is programmed.

## Programmable Pads

Pads do not come programmed from factory. Pads 1–8 can be programmed to cook according to frequently used sequences. When a pad is pressed, oven begins cooking with microwave, convection, or combination function according to previous programming.

## Microwave

Microwave mode cooks using 1000 watts I.E.C. 705 microwave power. Place items to be cooked on rack. If only 1 rack is required for cooking, remove extra rack for best results. Use microwave-safe containers while cooking in microwave mode.

When cooking in microwave mode, oven cavity warms to 70°C/150°F to reduce condensation. A warm oven cavity may affect cooking times. When oven cavity is warming, "c" appears in oven display.

Microwave cooking times range from 1 second (00:01) to a total of 20 minutes (20:00) over 4 stages. If more than 20 minutes of total microwave cooking time is required, open door and inspect food before beginning new cooking cycle. Microwave power levels range from "10%" to "HI". "HI" is 100 percent power. If cooking time is set and *START* pad pressed, oven cooks at 100 percent power.

## Convection

Convection mode cooks by circulating hot air around food. Preheat oven before using convection mode for best results. Place items to be cooked on rack for best results.

Cooking time ranges from 1 second (00:01) to a total of 60 minutes (60:00) over 4 stages. Cooking temperatures range from 70°C/150°F to 250°C/475°F in increments of 10°C/25°F.

## Combination

Combination mode cooks using microwave energy and convection heat. Preheat oven before using combination mode for best results. Metal utensils may be used in combination mode when necessary. Use heat-resistant, microwave-safe utensils when possible. Place items to be cooked on rack for best results.

Cooking times range from 1 second (00:01) to a total of 20 minutes (20:00) over 4 stages. Temperature and power level settings combination mode are same as convection and microwave mode.

## User Options

User options allow oven to operate according to individual preferences. See "Programming User Options" section in Programming Instructions.

# Cooking Displays

c, m, or cm	"c" indicates convection element is producing heat. "m" indicates oven is producing microwave energy. "cm" indicates oven is producing microwave energy and convection heat. Indicators are located in lower right corner of oven display.
CLOSE DOOR	Displays when oven door is open. Element is no longer active because door has been open more than 15 seconds. Oven is in convection, combination, or preheat mode.
DOOR OPEN	Displays when oven door is open.
FINISHED REMOVE FOOD (A, B, C) PAD (1-8)	Displays at end of cooking cycle.
MANUAL COOKING	Shows while cooking with manual cooking function.
MANUAL COOKING PAUSE	Displays when cooking is interrupted by opening door or pushing STOP/RESET pad.
MAXIMUM ALLOWABLE DEFAULT COOK TIME	Displays in user option mode when greatest default cook time is reached. (Maximum = 10:00)
MAXIMUM ALLOWABLE MICROWAVE COOK TIME	Displays when no additional microwave cooking time can be added. (Maximum = 20:00)
MAXIMUM ALLOWABLE TOTAL COOK TIME	Displays when no additional cooking time can be added. (Maximum = 60:00)
MENU (A,B, or C)	Indicates which menu is selected for programming.
MICRO (10%-HI)	Indicates microwave power level.
(A, B, C) PAD (1-8) COOKING	Displays while cooking with programmable pad.
(A, B, C) PAD (1-8) PAUSE	Displays when cooking is interrupted by opening door or pushing STOP/RESET pad.
(0, 150-475F) PREHEAT (0, 70-250C)	Indicates temperature when preheat is selected.
PROGRAM NOT FOUND PROGRAM PAD (1-8) TO USE	Indicates selected programmable pad has not been programmed.
PROGRAMMING STAGE (1-4)	Indicates beginning of a new programming stage.
PUSH RESET TO DELETE START TO START OVER	Displays when STOP/RESET pad is pressed while oven is being programmed.
READY	Displays when oven is in ready mode. If "R" is flashing, pads are active.
READY c	Displays after oven has reached preheat temperature. If "R" is flashing, pads are active.
SELECT COOK FUNCTION	Displays after beginning of a new stage while programming.
STAGE (1-4)	Indicates present cooking stage.
STANDBY	Displays when oven is in standby mode.
WARM UP c	Displays when oven is preheating.
WELCOME STANDBY	Displays when oven receives power.

## Default Cooking Time

Oven is factory preset to cook for 2 minutes, "2:00", when cooking function (MICROWAVE, CONVECTION, or COMBINATION) is selected. To change default cooking time, see "Programming User Options" section of manual.

## Default Preheat Temperature

When power is connected to oven, oven sets preheat temperature to 250°C/475°F. If preheat has been set before, oven resets to previous preheat temperature when *PREHEAT* pad is selected.

## Default Cooking Temperature

If oven was preheated oven sets cooking temperature to previous preheat temperature. If oven was not preheated temperature sets to 250°C/475°F.

## Preheat/Convection Indicator

When oven preheats or cooks, oven shows "c" in display. "c" indicates heating element is on. While oven is in preheat or convection mode, "c" disappears as heating element cycles off to maintain temperature. To indicate warming of oven cavity, "c" may appear when door is open or in microwave mode.

## Microwave Indicator

When oven cooks using microwave energy, oven shows "m" in display. While oven uses power levels other than 100 percent, "m" disappears as oven cycles off.

## Flashing Items

When programming oven to cook, items in display flash indicating what needs to be set. For example, when setting the time, colon (:) flashes. When setting cooking temperature, "F" or "C" flashes. When setting microwave power levels, percent (%) flashes.

When oven is in ready mode, "R" in ready flashes indicating oven is ready for next entry. "R" in "READY" flashes for 2 minutes.







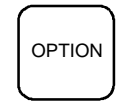
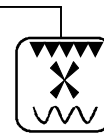
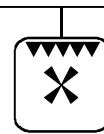
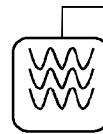
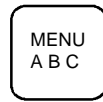
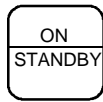
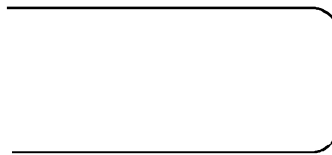



When oven heats to reach preheat temperature, oven display shows "WARMUP" with "W" flashing. While "W" flashes, pads are active and oven accepts entries.

"W" in "WARMUP" flashes for 2 minutes.

# Control Pads



MICROWAVE CONVECTION COMBINATION

HIDDEN ENABLE PAD		Accesses programming for user options mode.
ON/STANDBY		Enables and disables pads. If oven shows "STANDBY", press ON/STANDBY pad to set oven to ready mode. Oven sets to standby mode if oven display shows "READY" and ON/STANDBY pad is pressed.
PREHEAT		Sets oven to preheat mode.
MENU A B C		Selects programmable cooking menus.
MICROWAVE		Selects microwave function.
CONVECTION		Selects convection function.
COMBINATION		Selects combination function.
OPTION		Advances programming. Advances time to oven temperature, oven temperature to power level, and then to next cooking stage.
Up and Down Arrows		Adjusts time, oven temperature, and power levels.
PADS 1-8		Starts programmed cooking sequences.
START		Begins operation of manual cooking functions. Saves programming and enters preheat temperature.
STOP/RESET		Pauses cooking and resets oven program.

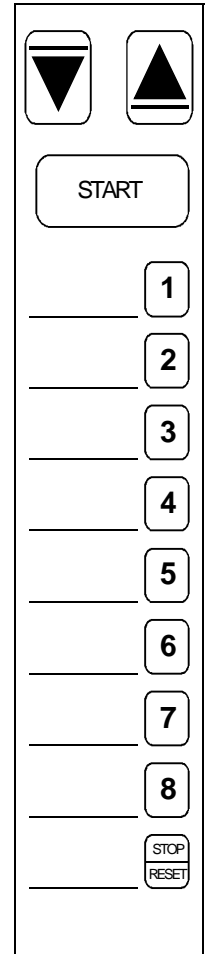

# Operating Instructions

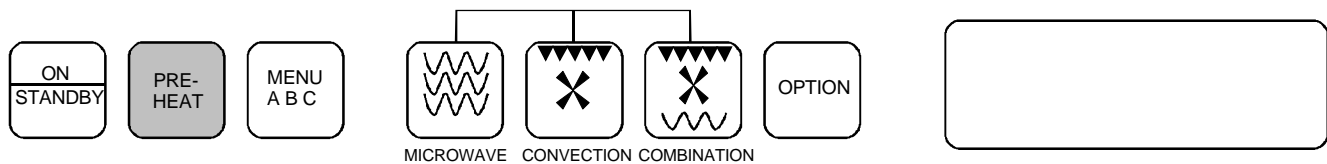

## Preheat Entry

Preheat uses convection heat to bring oven temperature to desired cooking temperature. Preheat before convection or combination cooking for best results.



### CAUTION

To prevent personal injury, handle utensils, racks, and door with care. Utensils, racks, and door may become hot during operation.

## Operating Preheat Function

1. Verify oven display shows "READY".
  - If oven display shows "STANDBY", press *ON/STANDBY* pad.
  - If "R" in "READY" is not flashing, open and close oven door.
2. Press *PREHEAT* pad to enter preheat mode. "F" flashes after temperature.

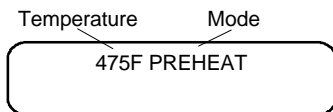

3. Press arrow pads to increase or decrease preheat temperature.
4. Press *START* pad to begin preheat mode. Oven heats until oven reaches preheat temperature. "WARMUP" appears.

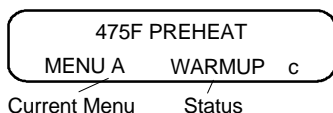

5. Oven signals when oven reaches preheat temperature. "READY" appears. Oven is ready to accept next entry if "R" is flashing.

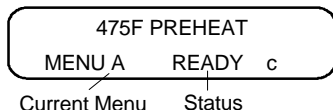

## Reset or Cancel

1. Press *PREHEAT* pad. Oven display shows preheat temperature, flashing "F" and "PREHEAT".
2. Press arrow pads to adjust preheat temperature. To cancel preheat mode, press down arrow pad until oven display shows "OF".
3. Press *START* pad.

## Summary of Preheat Function

1. Verify oven display shows "READY".
2. Press *PREHEAT* pad.
3. Press arrows to select temperature.
4. Press *START* pad.
5. Oven signals when oven reaches preheat temperature.

# Operating Instructions

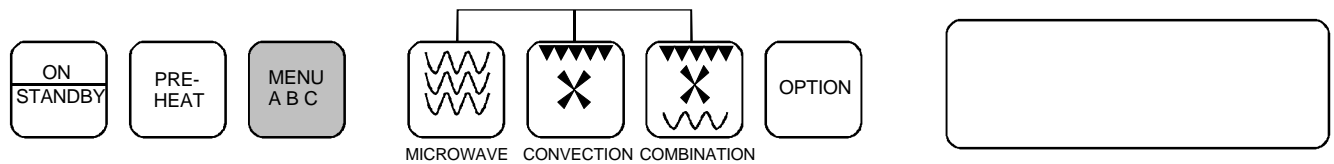

## Programmable Menu Entry

Oven contains 3 programmable menus with 8 programmable number pads. Program programmable number pads to form menus. To set programmable pads, see "Programming Pads (1–8)" section.



### CAUTION

To prevent personal injury, handle utensils, racks, and door with care. Utensils, racks, and door may become hot during operation.

## Operating Programmable Menu Items

1. Verify Oven shows "READY" in display.
  - If oven display shows "STANDBY", press *ON/STANDBY* pad.
  - If "R" in "READY" is not flashing, open and close oven door.
  - Preheat temperature and "PREHEAT" appear in display if oven is in preheat mode.
2. Close oven door. "R" in "READY" flashes. Preheat temperature and "PREHEAT" appear in display if oven is in preheat mode.

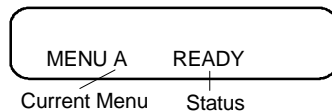

3. Press *MENU A B C* pad to select programmable menu.
4. Press numbered pad (1–8) to begin cooking. Oven display reflects programming. If pad is not programmed, see "Programming Pads (1–8)" section.
  - Oven stops and signals at end of cooking sequence.
5. Remove food to avoid overcooking.

## Pause or Cancel

1. Press *STOP/RESET* pad or open oven door to pause cooking sequence. Press *START* pad to resume operation.
2. Press *STOP/RESET* pad again to cancel cooking program.

## Summary of Programmable Menu Items

1. Verify oven display shows "READY".
2. Open oven door, place food in oven, and close oven door.
3. Select menu (A, B, or C).
4. Press numbered pad.
5. Remove food.

# Operating Instructions

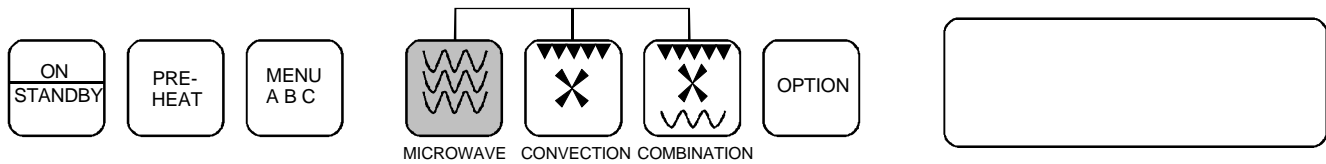

## Manual Microwave Entry

Microwave function cooks using microwave energy. Set cooking time and power levels.



### CAUTION

To prevent personal injury, handle utensils, racks, and door with care. Utensils, racks, and door may become hot during operation.

## Operating Microwave Function

- Verify Oven shows "READY" in display.
  - If oven display shows "STANDBY", press *ON/STANDBY* pad.
  - If "R" in "READY" is not flashing, open and close oven door.
  - Preheat temperature and "PREHEAT" appear in display if oven is in preheat mode.

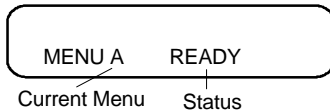

- Press *MICROWAVE* pad to select microwave cooking function. Colon (:) in cooking time flashes.

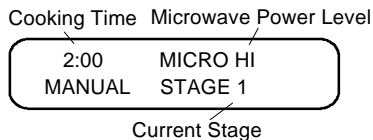

- Press arrow pads to add or subtract cooking time.
- Press *OPTION* pad.
- Press arrow pads to increase or decrease microwave power level. For example, press the down arrow once for "90%". "HI" is 100 percent microwave power level.
  - If no additional cooking stages are required, go to step 7.

- Press *OPTION* pad. Oven display shows "PROGRAMMING STAGE (2-4)" for 2 seconds, and then display shown below.

- Repeat steps 3-7 if additional cooking stages are required. See "Oven Operation" in "Cooking" section for explanation of stages.

SELECT COOK FUNCTION  
MANUAL STAGE 2

- Open oven door, place food in oven, and close door.
- Press *START* pad. Total time for each stage selected counts down. Oven stops and signals at end of cooking sequence.
- Remove food to avoid overcooking.

## Pause or Cancel

- Press *STOP/RESET* pad or open oven door to pause cooking sequence. Press *START* pad to resume operation.
- Press *STOP/RESET* pad again to cancel cooking program.

## Summary of Microwave Function

- Verify oven display shows "READY".
- Press *MICROWAVE* pad.
- Press arrow pads to add or subtract cooking time.
- Press *OPTION* pad.
- Press arrow pads to increase or decrease microwave power level.
- Press *OPTION* pad. Repeat steps 2-7 for additional stages.
- Open oven door, place food in oven, and close door.
- Press *START* pad.
- Remove food.



# Operating Instructions

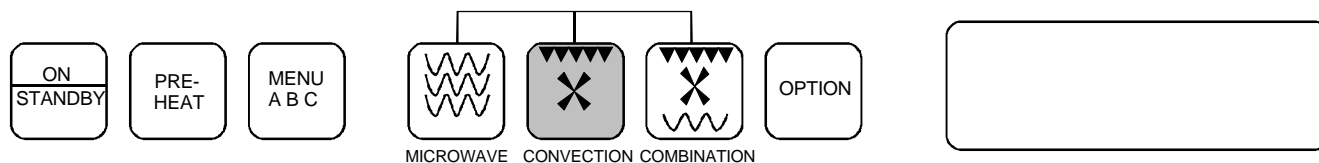

## Manual Convection Entry

Preheat oven before using convection function for best results. Set time and temperature.



### CAUTION

To prevent personal injury, handle utensils, racks, and door with care. Utensils, racks, and door may become hot during operation.

## Operating Convection Function

1. Set preheat mode. See “Preheat Entry” section to set preheat mode.
2. Verify Oven shows “READY” in display.
  - If oven display shows “STANDBY”, press *ON/STANDBY* pad.
  - If “R” in “READY” is not flashing, open and close oven door.
  - Preheat temperature and “PREHEAT” appear in display if oven is in preheat mode.

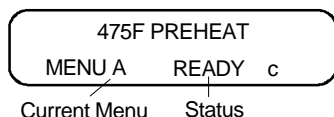

3. Press *CONVECTION* pad to select convection cooking function. Colon (:) in cooking time flashes.

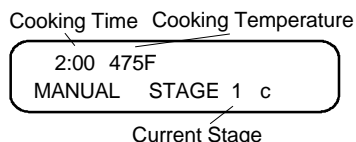

4. Press arrow pads to add or subtract cooking time.
5. Press *OPTION* pad. “F” flashes after temperature.
6. Press arrow pads to increase or decrease cooking temperature. Cooking temperature should equal preheat temperature for best results.
  - If no additional cooking stages are required, go to step 8.

7. Press *OPTION* pad. Oven display shows “PROGRAMMING STAGE (2–4)” for 2 seconds, and then display shown below.
  - Repeat steps 3–7 if additional cooking stages are required. See “Oven Operation” section under “Cooking” for explanation of cooking stages.

SELECT COOK FUNCTION  
MANUAL STAGE 2

8. Open oven door, place food in oven, and close door.
9. Press *START* pad. Total time for each stage selected counts down. Oven stops and signals at end of cooking sequence.
10. Remove food to avoid overcooking.

## Pause or Cancel

1. Press *STOP/RESET* pad or open oven door to pause cooking sequence. Press *START* pad to resume operation.
2. Press *STOP/RESET* pad again to cancel cooking program.

## Summary of Convection Function

1. Set preheat mode.
2. Verify oven display shows “READY”.
3. Press *CONVECTION* pad.
4. Press arrow pads to add or subtract cooking time.
5. Press *OPTION* pad.
6. Press arrow pads increase or decrease cooking temperature.
7. Press *OPTION* pad. Repeat steps 3–7 for additional stages.
8. Open oven door, place food in oven, and close door.
9. Press *START* pad.
10. Remove food.

# Operating Instructions

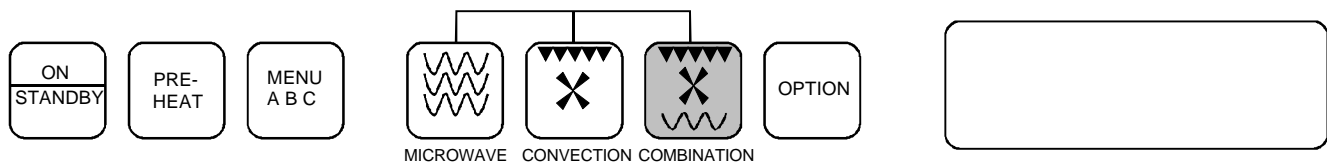

## Manual Combination Entry

Combination function cooks using a combination of convection heat and microwave energy. Preheat oven before using combination function for best results. Set time, temperature, and microwave power level.



### CAUTION

To prevent personal injury, handle utensils, racks, and door with care. Utensils, racks, and door may become hot during operation.

## Operating Combination Function

1. Set preheat mode. See “Preheat Entry” section to set preheat mode.
2. Verify oven shows “READY” in display.
  - If oven display shows “STANDBY”, press *ON/STANDBY* pad.
  - If “R” in “READY” is not flashing, open and close oven door.
  - Preheat temperature and “PREHEAT” appear in display if oven is in preheat mode.

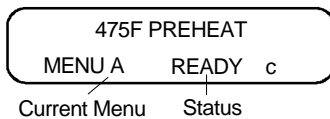

3. Press *COMBINATION* pad to select combination function. Colon (:) in cooking time flashes.

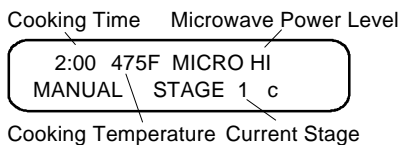

4. Press arrow keys to add or subtract cooking time.
5. Press *OPTION* pad. “F” flashes after temperature.
6. Press arrow pads to increase or decrease oven temperature. Cooking temperature should equal preheat temperature for best results.
7. Press *OPTION* pad.
8. Press arrow pads to increase or decrease microwave power level. For example, press the down arrow once for “90%”.
  - If no additional cooking stages are required go to step 10.

9. Press *OPTION* pad. Oven display shows “PROGRAMMING STAGE (2–4)” for 2 seconds, and then display shown below.
  - Repeat steps 3–7 if additional cooking stages are required. See “Oven Operation” in “Cooking” section for explanation of cooking stages.

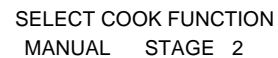

10. Open oven door, place food in oven, and close door.
11. Press *START* pad. Total time for each stage selected counts down. Oven stops and signals at end of cooking sequence.
12. Remove food to avoid overcooking.

## Pause or Cancel

1. Press *STOP/RESET* pad or open oven door to pause cooking sequence. Press *START* pad to resume operation.
2. Press *STOP/RESET* pad again to cancel cooking program.

## Summary of Combination Function

1. Preheat oven.
2. Verify oven display shows “READY”.
3. Press *COMBINATION* pad.
4. Press arrow pads to add or subtract cooking time.
5. Press *OPTION* pad.
6. Press arrow pads increase or decrease cooking temperature.
7. Press *OPTION* pad.
8. Press arrow pads increase or decrease microwave power level.
9. Press *OPTION* pad. Repeat steps 3–7 for additional stages.
10. Open oven door, place food in oven, and close door.
11. Press *START* pad.
12. Remove food.

# Programming Instructions

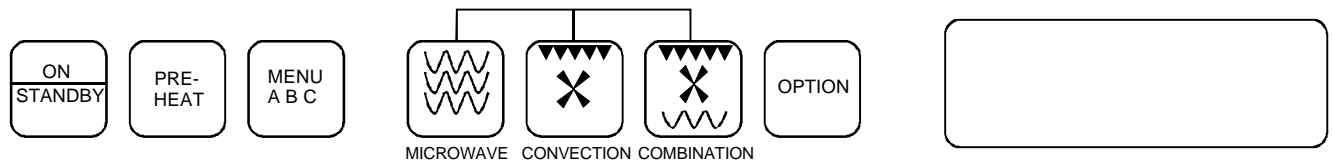

## Programming Pads (1–8)

Pads (1–8) activate a programmed cooking sequence when pressed. Program each pad individually to form menus. Programming remains in memory until reprogrammed.

## Programming Mode

- Verify Oven shows “READY” in display.
  - If oven display shows “STANDBY”, press *ON/STANDBY* pad.
  - If “R” in “READY” is not flashing, open and close oven door.
  - Preheat temperature and “PREHEAT” appear in display if oven is in preheat mode.
- Open oven door. Oven door must remain open during programming.
- Press and hold 1 pad for approximately 3-5 seconds.

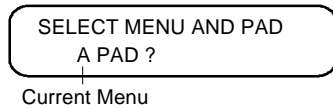

- Press *MENU A B C* pad, if necessary, to select menu.
- Press desired (1–8) pad.

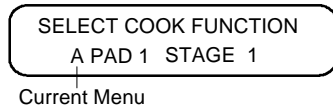

- Press *MICROWAVE*, *CONVECTION*, or *COMBINATION* pad to select cooking function.
- Set time, temperature, and/or power levels.
  - If *MICROWAVE* pad is chosen, see “Manual Microwave Entry” steps 3–6.
  - If *CONVECTION* pad is chosen, see “Manual Convection Entry” steps 4–7.
  - If *COMBINATION* pad is chosen, see “Manual Combination Entry” steps 4–9.

- Press *OPTION* pad after setting time, temperature, and/or power levels to advance to next stage.
  - Repeat steps 4–6 up to 4 times to create a maximum of 4 cooking stages. If no additional cooking stages are required, go to next step.



- Press *START* pad to save cooking sequences. Oven display shows “SELECT MENU AND PAD” and “(A, B, or C) PAD ?”.
  - Repeat steps 4-8 to program additional pads.
- Close oven door to exit programming mode.

## Summary of Programming Mode

- Open oven door.
- Press and hold “1” pad.
- Press *MENU A B C* pad to select menu.
- Press (1–8) pad to be programmed.
- Press *MICROWAVE*, *CONVECTION*, or *COMBINATION* pad.
- Set time, temperature, and microwave power level according to instructions.
- Press *OPTION* pad to set second stage or *START* pad to save entry. Repeat 4-8 to program additional pads.
- Close oven door.

# Programming Instructions

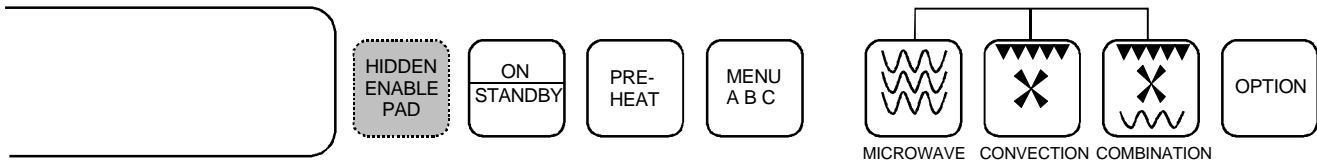

## Programming User Options

User options change oven features to meet specific needs. See associated table for options.

## Setting User Options

1. Verify Oven shows "READY" in display.
  - If oven display shows "STANDBY", press *ON/STANDBY* pad.
  - If "R" in "READY" is not flashing, open and close oven door.
  - Preheat temperature and "PREHEAT" appear in display if oven is in preheat mode.
2. Open oven door. Oven door must remain open during programming.
3. Press and hold *1* pad for approximately 3–5 seconds.

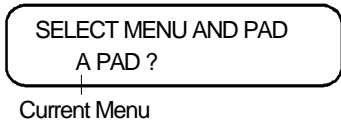

4. Press hidden enable pad located left of *ON/STANDBY* pad.

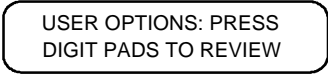

5. Press (1–8) pads to review options. See associated table for descriptions.
6. Press arrow pads to select option.
7. Press *START* pad to enter option.
8. Close door to exit user options programming mode.

## Summary of Setting User Options

1. Open oven door.
2. Press and hold *1* pad.
3. Press hidden enable pad.
4. Press (1–8) pads.
5. Press arrow pads.
6. Press *START* pad to save.
7. Close door to exit.

# Programming Instructions

## User Options for CMA2230, CCMA2230, MM2230C, and CMM2230C



Number Pads	Display Titles	Options ( ) = Factory Setting	Description
1	MANUAL PROGRAMMING	(ENABLE) or DISABLE	Allows or prevents manual programming of oven.
2	SLEW RATE	SLOW, MEDIUM, (MEDIUM-FAST), or FAST	Controls speed of arrow pads.
3	TEMP SCALE DEGREES	(F) or C	Displays temperatures in Fahrenheit or Celsius. When oven converts preprogrammed and default temperatures from Fahrenheit to Celsius, temperatures set to the next lowest factor of 10 degrees Celsius. From Celsius to Fahrenheit, temperatures set to the next lowest factor of 25 degrees Fahrenheit.
4	DEFAULT COOK TIME	(2:00) 00:00-10:00	Sets default cooking time.
5	SPEAKER VOLUME	LOW, MEDIUM, (HIGH), or OFF	Controls oven signal volume.
6	KEYBEEPS	(ON) or OFF	Controls whether pads signal when pressed.
7	END OF CYCLE TONE	(CONTINUOUS TONE), CONTINUOUS BEEP, 4 CYCLES OF BEEP, or 3 SECOND TONE	Determines how oven signals at end of cycle.
8	MAGNETRON HOURS DOOR CYCLES	MAGNETRON HOURS and DOOR CYCLES	Displays how many hours magnetron tube has operated and how many times door has been opened and closed.

# Component Testing Procedures



## WARNING

To avoid risk of electrical shock, personal injury, or death, disconnect power to oven and discharge capacitor before servicing, unless testing requires it.

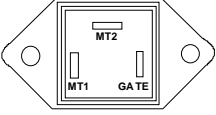
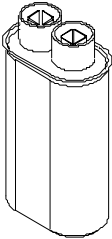
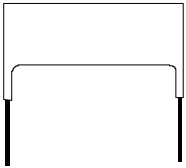
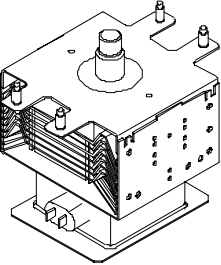
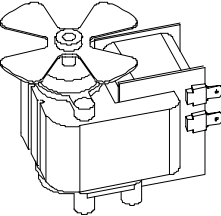
	Thermal Cutout	Disconnect all wires from TCO. Measure resistance across terminals. Control TCO Fan TCO Magnetron TCO	Open at 300°F and closed at 257°F Closed at 160°F and open at 125°F Open at 235°F and closed at 150°F
	Diode	<b>Discharge Capacitor</b>  Remove diode lead from capacitor and connect ohmmeter.  Reverse leads for second test.	Infinite resistance could be measured in one direction and 50K $\Omega$ or more in the opposite direction.  <b>NOTE:</b> Ohmmeter must contain a battery of 6 volts minimum.
	Triac	Disconnect wires to triac.  Measure resistance from: MT1 to MT2 MT1 to Gate MT2 to Gate All terminals to ground	<b>Caution - Do not operate oven with wire to terminal MT2 removed.</b>  Infinite Approximately 40 $\Omega$ or more Infinite Infinite
	Capacitor	<b>Discharge Capacitor</b>  Remove wires from capacitor terminals and connect ohmmeter, set on highest resistance scale to terminals.  Also check between each terminal and capacitor case.	Between Terminals: Meter should momentarily deflect towards zero then return to over 5 M $\Omega$ . IF no deflection occurs, or if continuous deflection occurs, replace capacitor.  Terminal to Case: Infinite resistance
	Snubber Assembly	Disconnect wires to snubber.  Measure resistance across terminals.	Infinite
	Magnetron	<b>Discharge Capacitor</b>  Remove wires from magnetron and connect ohmmeter to terminals. Also check between each terminal and ground.	Between Terminals: Less than 1 $\Omega$  Each terminal to ground measures Infinite resistance. <b>Note:</b> This test is not conclusive. If oven does not heat and all other components test good replace the magnetron and retest.
	Microwave Blower Motor	Remove all wires from motor.  Measure resistance across coil.	Approximately 33.5 $\Omega$

# Component Testing Procedures



To avoid risk of electrical shock, personal injury, or death, disconnect power to oven and discharge capacitor before servicing, unless testing requires it.

	Transformer	<p><b>Discharge Capacitor</b> Remove all wires from terminals.</p> <p>Measure resistance from: 230 to COM 208 to COM 230 to Ground 208 to Ground Terminal 5 to 6 Terminal 4 to Ground</p>	<p>Less than 1.5 <math>\Omega</math> Less than 1.5 <math>\Omega</math> Infinite Infinite Less than 1 <math>\Omega</math> Approximately 115 <math>\Omega</math></p>
	Auto Transformer	<p><b>Discharge Capacitor</b> Remove all wires from terminals.</p> <p>Measure resistance from: 230 to 0 208 to 0 230 to 208</p>	<p>47.3 <math>\Omega</math> 39.1 <math>\Omega</math> 8.6 <math>\Omega</math></p>
	Interlock Switch	<p>Disconnect wires to switch.</p> <p>With door open measure resistance from: Terminal 2 to 3 Terminal 4 to 5 Terminal 7 to 8</p> <p>With door closed measure resistance from: Terminal 2 to 3 Terminal 4 to 5 Terminal 7 to 8</p>	<p>Infinite Infinite Indicates continuity</p> <p>Indicates continuity Indicates continuity Infinite</p>
	Convection Blower Motor	<p>Remove wires from motor.</p> <p>Measure resistance across terminals A and B.</p>	<p>Approximately 40 <math>\Omega</math></p>
	Calrod Assembly	<p>Disconnect wires from terminals.</p> <p>Measure resistance across heating element.</p>	<p>Indicates continuity</p>
	Resistance Thermal Device (RTD)	<p>Temperature</p> <p>32°F</p> <p>350°F</p>	<p>Resistance</p> <p>1000 <math>\Omega</math></p> <p>1654 <math>\Omega</math></p>
	Lamp Receptacle	<p>Test continuity of receptacle terminals.</p>	<p>Indicates continuity with bulb screwed in.</p>

# Component Testing Procedures



## WARNING

To avoid risk of electrical shock, personal injury, or death, disconnect power to oven and discharge capacitor before servicing, unless testing requires it.

	High Voltage Board	<p>J-1 Pin 12 to Ground</p> <p>J-1 Pin 10 to Ground</p> <p>J-3 Pin 1 to J3 pin 3</p>	<p>12 VDC</p> <p>Continuity</p> <p>Line Voltage</p>																																							
	Low Voltage Board	<p>J-2 Pin 12 to Ground</p> <p>J-2 Pin 10 to Ground</p>	<p>12 VDC</p> <p>Continuity</p>																																							
	<p>Side Touch Panel for: CMA2230 CCMA2230 CMM2230C MM2230C</p>	<p>Continuity is indicated as 100 Ω and below.</p>	<table border="1"> <thead> <tr> <th>Pad</th> <th>Trace</th> <th>Measurement</th> </tr> </thead> <tbody> <tr><td>1</td><td>8 &amp; 9</td><td>Continuity</td></tr> <tr><td>2</td><td>7 &amp; 9</td><td>Continuity</td></tr> <tr><td>3</td><td>1 &amp; 7</td><td>Continuity</td></tr> <tr><td>4</td><td>1 &amp; 6</td><td>Continuity</td></tr> <tr><td>5</td><td>5 &amp; 6</td><td>Continuity</td></tr> <tr><td>6</td><td>4 &amp; 6</td><td>Continuity</td></tr> <tr><td>7</td><td>3 &amp; 4</td><td>Continuity</td></tr> <tr><td>8</td><td>1 &amp; 3</td><td>Continuity</td></tr> <tr><td>Slew Down</td><td>10 &amp; 12</td><td>Continuity</td></tr> <tr><td>Slew Up</td><td>11 &amp; 12</td><td>Continuity</td></tr> <tr><td>Start</td><td>1 &amp; 9</td><td>Continuity</td></tr> <tr><td>Stop/Reset</td><td>2 &amp; 3</td><td>Continuity</td></tr> </tbody> </table>	Pad	Trace	Measurement	1	8 & 9	Continuity	2	7 & 9	Continuity	3	1 & 7	Continuity	4	1 & 6	Continuity	5	5 & 6	Continuity	6	4 & 6	Continuity	7	3 & 4	Continuity	8	1 & 3	Continuity	Slew Down	10 & 12	Continuity	Slew Up	11 & 12	Continuity	Start	1 & 9	Continuity	Stop/Reset	2 & 3	Continuity
Pad	Trace	Measurement																																								
1	8 & 9	Continuity																																								
2	7 & 9	Continuity																																								
3	1 & 7	Continuity																																								
4	1 & 6	Continuity																																								
5	5 & 6	Continuity																																								
6	4 & 6	Continuity																																								
7	3 & 4	Continuity																																								
8	1 & 3	Continuity																																								
Slew Down	10 & 12	Continuity																																								
Slew Up	11 & 12	Continuity																																								
Start	1 & 9	Continuity																																								
Stop/Reset	2 & 3	Continuity																																								
	<p>Top Touch Panel CMA2230 CCMA2230 CMM2230C MM2230C</p>	<p>Continuity is indicated as 100 Ω and below.</p>	<table border="1"> <thead> <tr> <th>Pad</th> <th>Trace</th> <th>Measurement</th> </tr> </thead> <tbody> <tr><td>Menu</td><td>8 &amp; 9</td><td>Continuity</td></tr> <tr><td>Microwave</td><td>7 &amp; 9</td><td>Continuity</td></tr> <tr><td>On/Standby</td><td>2 &amp; 9</td><td>Continuity</td></tr> <tr><td>Convection</td><td>4 &amp; 7</td><td>Continuity</td></tr> <tr><td>Option</td><td>5 &amp; 6</td><td>Continuity</td></tr> <tr><td>Combination</td><td>4 &amp; 6</td><td>Continuity</td></tr> <tr><td>Preheat</td><td>2 &amp; 4</td><td>Continuity</td></tr> <tr><td>Enable (Hidden)</td><td>2 &amp; 3</td><td>Continuity</td></tr> </tbody> </table>	Pad	Trace	Measurement	Menu	8 & 9	Continuity	Microwave	7 & 9	Continuity	On/Standby	2 & 9	Continuity	Convection	4 & 7	Continuity	Option	5 & 6	Continuity	Combination	4 & 6	Continuity	Preheat	2 & 4	Continuity	Enable (Hidden)	2 & 3	Continuity												
Pad	Trace	Measurement																																								
Menu	8 & 9	Continuity																																								
Microwave	7 & 9	Continuity																																								
On/Standby	2 & 9	Continuity																																								
Convection	4 & 7	Continuity																																								
Option	5 & 6	Continuity																																								
Combination	4 & 6	Continuity																																								
Preheat	2 & 4	Continuity																																								
Enable (Hidden)	2 & 3	Continuity																																								
	<p>Display Module Connector</p>	<p>Pin 2 to Ground</p> <p>Pin 4 to Ground</p> <p>Pin 6 to Ground</p> <p>Pin 10 to Ground</p> <p>Pin 12 to Ground</p> <p>Pin 11 to Ground</p>	<p>5 VDC</p> <p>5 VDC</p> <p>5 VDC</p> <p>Continuity</p> <p>Continuity</p> <p>Continuity</p>																																							
<p>Wire Harness</p>	<p>Low Voltage Board to Display Module Harness</p>	<p>Test continuity of wires.</p>	<p>Indicates continuity</p>																																							
<p>Wire Harness</p>	<p>Low Voltage Board to High Voltage Board Harness</p>	<p>Test continuity of wires.</p>	<p>Indicates continuity</p>																																							



# Test Modes

## Microwave Power Test

### (TRADITIONAL TEST METHOD)

Test Equipment Needed:

- Amana power test kit R0157397 or
  - Menumaster power test kit M95D5.
1. Place one rack in the oven using lowest rack position.
  2. Fill the plastic container to the bottom of the 1000 ml. lines with cool tap water.
  3. Using the thermometer; Fahrenheit or Centigrade, stir the water, measure and record the water temperature. **IMPORTANT:** Initial water temperature should be approximately 60°F (20°C).
  4. Place the container on the center of the oven shelf and heat the water for 62 seconds.
    - a. Press ON/STANDBY
    - b. Press Menu C
    - c. Press pad 7

**NOTE:** If regular microwave time is entered, convection heat will come on for 15 minutes.

5. Stir the water, measure and record the temperature of the water after heating time is completed.
6. Subtract the starting water temperature (Step 3) from the ending water temperature (Step 5) to obtain the temperature rise.
7. Refer to the Temperature Chart.

**NOTE:** Variation or errors in the test procedure will cause a variance in the temperature rise indication. Additional power tests should be made if temperature rise appears marginal.

**NOTE:** Low line voltage may cause lower power output (temperature rise).

## Temperature Chart

**ONE MINUTE, TWO SECONDS run time chart for units less than 1550 watts cooking power.**

$\Delta T$ (°F)	Cooking Power Output	$\Delta T$ (°F)	Cooking Power Output
12	464	26	1007
13	504	27	1046
14	542	28	1085
15	581	29	1124
16	620	30	1162
17	659	31	1201
18	697	32	1240
19	736	33	1279
20	775	34	1317
21	814	35	1359
22	852	36	1395
23	891	37	1434
24	930	38	1472
25	969	39	1511
		40	1550

$\Delta T$ (°C)	Cooking Power Output	$\Delta T$ (°C)	Cooking Power Output
7	490	15	1050
8	560	16	1120
9	630	17	1190
10	700	18	1260
11	770	19	1330
12	840	20	1400
13	910	21	1470
14	980		

# Test Modes

## Convection Temperature Test

**NOTE:** It is absolutely necessary to own and use a thermocouple type oven tester to accurately measure oven temperature. No other type of thermometer can take its place.

**NOTE:** Before testing an oven to check calibration, inspect the RTD for proper mounting.

1. Place one wire rack in center position. Remove other rack and all utensils.
2. Clip thermocouple to the center rack and run lead outside oven door, or wrap thermocouple around rack and have tip of thermocouple extend upward towards top of cavity approximately 1".
3. Press *ON/STANDBY* pad.
4. Enter 400°F.
5. Press *OPTION* pad.
6. Enter 20 minutes of time.
7. Press *START* pad.
8. Allow oven to cycle one time.
9. Record temperatures for two cycles.

### Example:

MIN. ON 386°F ON 390°F

MAX. OFF 410°F OFF 415°F

796°F + 805°F = 1601°F

$1601^{\circ}\text{F} / 4 = 400^{\circ}\text{F}$  average temperature

If the average temperature is too high or too low the oven temperature offset needs to be adjusted.

## Convection Temperature Calibration

**NOTE:** It is normal for the average oven temperature to vary from the oven setting by as much as 25°F. Difference will not effect cooking since recipes are written with this difference in mind.

### Calibration

1. Press *ON/STANDBY*.
2. Open oven door.
3. Press pads *1,3,5,7 STOP/RESET*.
4. Close oven door.
5. Press *PREHEAT* pad.

**NOTE:** Display will show the current offset setting.

6. Press the arrow pads to change the offset.
7. Press *START* pad to save offset changes.

**NOTE:** Retest the oven after any offset changes are made.

# Radiation Leakage Testing



## WARNING

Check for radiation leakage after servicing. Should the leakage be more than 4mW/cm<sup>2</sup> inform Amana immediately. After repairing or replacing any radiation safety device, keep a written record for future reference, as required by D.H.H.S. and HEW regulations. This requirement must be strictly observed. In addition, the leakage reading must be recorded on the service repair ticket while at the customer's location.

## Equipment

- Electromagnetic radiation monitor
- 600 cc glass beaker

## Procedure For Measuring Radiation Leakage

Note before measuring -

- Do not exceed meter full scale deflection. Leak monitor should initially be set to the highest scale.
  - To prevent false readings the test probe should be held by the grip portion of the handle only.
  - The scan speed is equal to one inch per antenna revolution or one inch per second if antenna speed is unknown.
  - Areas to be checked are all door seal areas and any venting parts.
  - Leakage with the outer panel removed, 4mW/cm<sup>2</sup> or less.
  - Leakage for fully assembled oven with door normally closed, 4mW/cm<sup>2</sup> or less.
  - Leakage for a fully assembly oven (before the latch switch (primary) is interrupted) while pulling the door, 4mW/cm<sup>2</sup> or less.
1. Open the oven door and verify that there is only one rack in place on the bottom rack hooks.
  2. Pour 275 ± 15 cc (9 oz ± 1/2 oz) of 20 ± 5°C. (68± 9°F.) water in a glass beaker which is graduated to 600 cc and place the beaker in the center of rack.
  3. Set the radiation monitor to 2450 MHz and use it following the manufacturer's recommended test procedure to assure correct results.
  4. While measuring the leakage, always use the two inch (5 cm) spacer supplied with the probe.
  5. Press the start pad or turn on the timer and with the magnetron oscillating, measure the leakage by holding the probe perpendicular to the surface being measured.

## Measurement With the Outer Case Removed



## DANGER

To avoid risk of personal injury or death avoid contacting any high voltage components.

Whenever you replace the magnetron, measure for radiation leakage before the outer case is installed and after all necessary components are replaced or adjusted. Special care should be taken in measuring around the magnetron.

## Measurement With a Fully Assembled Oven

After all components, including the outer panel are fully assembled, measure for radiation leakage around the door periphery, the door viewing window, the exhaust opening, and air inlet openings.

## Record Keeping and Notification After Measurement

1. After any adjustment or repair to a microwave oven, a leakage reading must be taken. Record this leakage reading on the repair ticket even if it is zero.
2. A copy of the repair ticket and the microwave leakage reading should be kept by the repair facility.

# Display Diagnostics

**CAUTION**

All repairs as described in this troubleshooting section are to be performed only after the caution procedures one through eight listed below have been followed.

1. Check grounding before checking for possible causes.
2. Be careful of the high voltage circuit.
3. Discharge high voltage capacitor.
4. When checking the continuity of the switches or the high voltage transformer, disconnect one lead wire from these parts and then check continuity with the AC plug removed. To do otherwise may result in a false reading or damage to your meter.
5. Do not touch any parts of the circuitry on the P.C. Board circuit since static electric discharge may damage this control panel. Always touch yourself to ground while working on this panel to discharge any static charge in your body.
6. 208 VAC is present in the high voltage circuit board, power relay and primary circuit of low voltage transformer.
7. When troubleshooting, be cautious of possible electrical hazard.
8. When testing convection operation, convection fan may start at any time or if oven is hot.

## Service Codes

During operation, the display may show the following service codes:

Display Codes	Possible Fault Indications
<b>SERVICE 1</b>	Inoperative Touch Panel. Replace H.V. board.
<b>SERVICE 2</b>	Broken or loose wire connection in RTD circuit (1-2K ohms). Open RTD (>2K ohms). Replace H.V. board.
<b>SERVICE 3</b>	Shorted RTD circuit. Improper wire connection. Replace H.V. board.
<b>SERVICE 4</b>	Replace L.V. board.
<b>SERVICE 4P</b>	Replace H.V. board.
<b>SERVICE 5</b>	-----
<b>SERVICE 6</b>	Replace H.V. board.
<b>SERVICE 7</b>	Broken or loose wire connection between H.V. board. Replace H.V. board. Replace L.V. board.
<b>SERVICE 8</b>	Replace H.V. board.
<b>HOT PLEASE WAIT</b>	Green wire on H.V. board, terminal E1, disconnected. Broken or loose wire connection. Replace T.C.O. Inoperative convection motor. Soiled oven filter. Replace H.V. board.

# Service Test

To Enter Test Mode

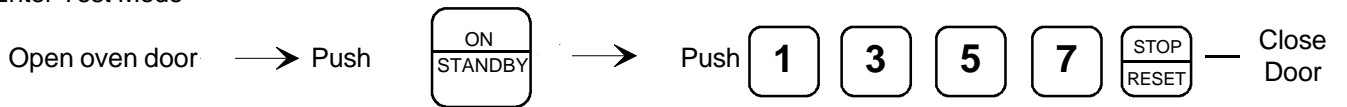

Press → Display

**1**

DIAG D062 A462  
002 90F S1

= Heating Element A

Temperature Increases

**2**

DIAG D062 A462  
002 90F S2

= Heating Element B

Temperature Increases

**3**

DIAG D062 A462  
002 :2 S M

= Microwave Operating

**4**

SPEAKER VOLUME  
HIGH

**5**

SPEAKER VOLUME  
MEDIUM

**6**

SPEAKER VOLUME  
LOW

**7**

PBD : ??????????????  
PWR : ??????????????

= High voltage board serial number  
= Low voltage board serial number

12 Digits

**8**

MAGNETRON HOURS 0000  
DOOR CYCLES 000000



To Exit Test Mode Press 

# Troubleshooting

## Power Up

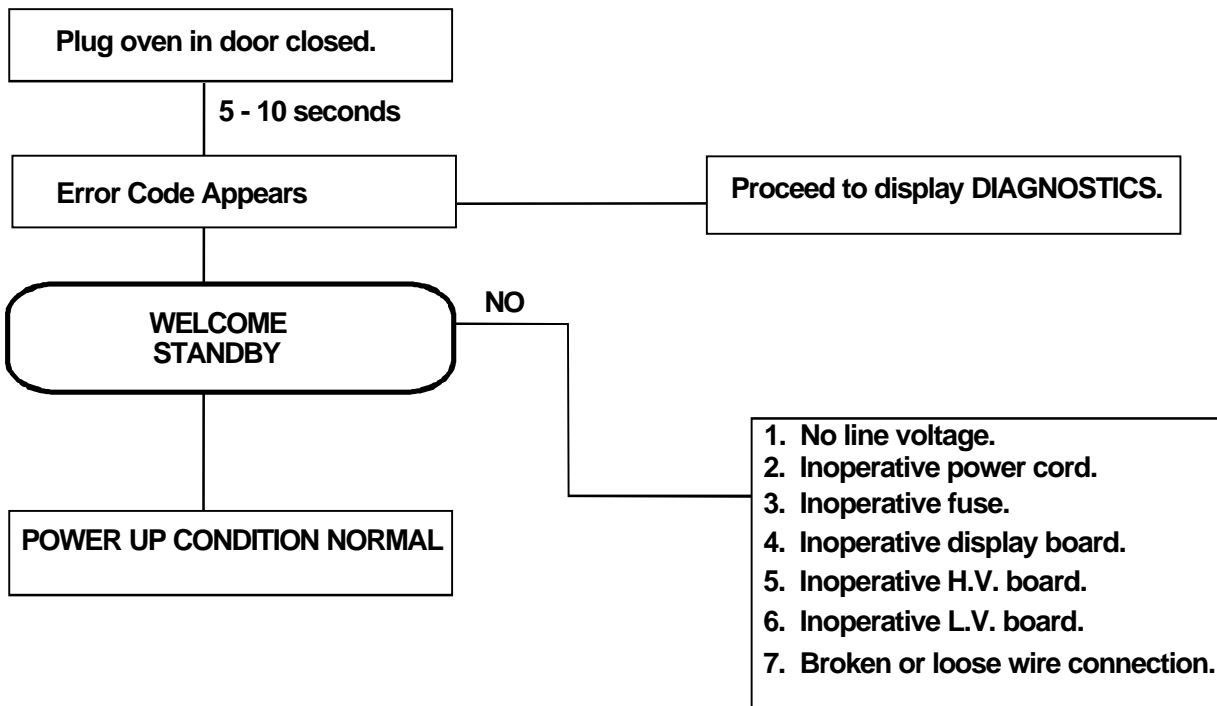

## Ready Condition

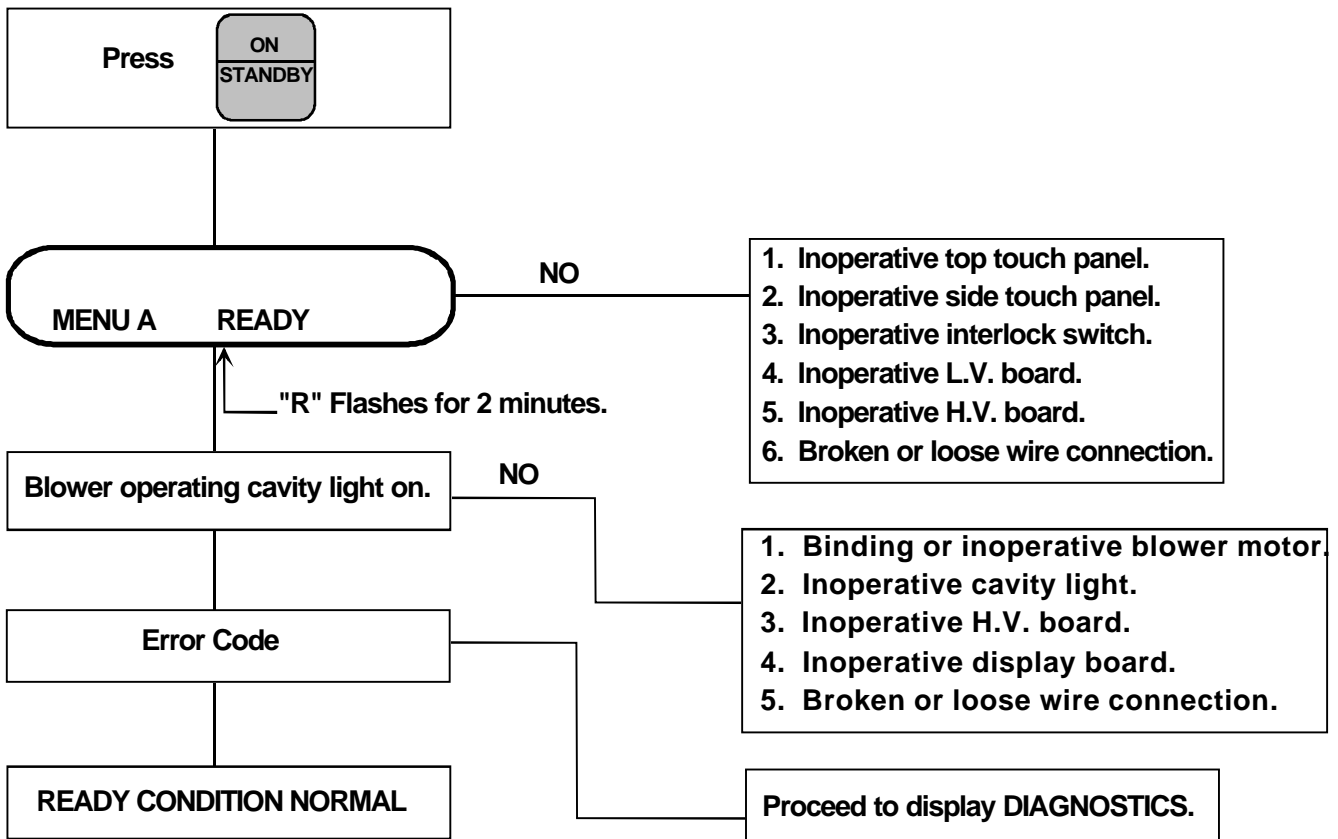

# Troubleshooting

## Microwave Condition

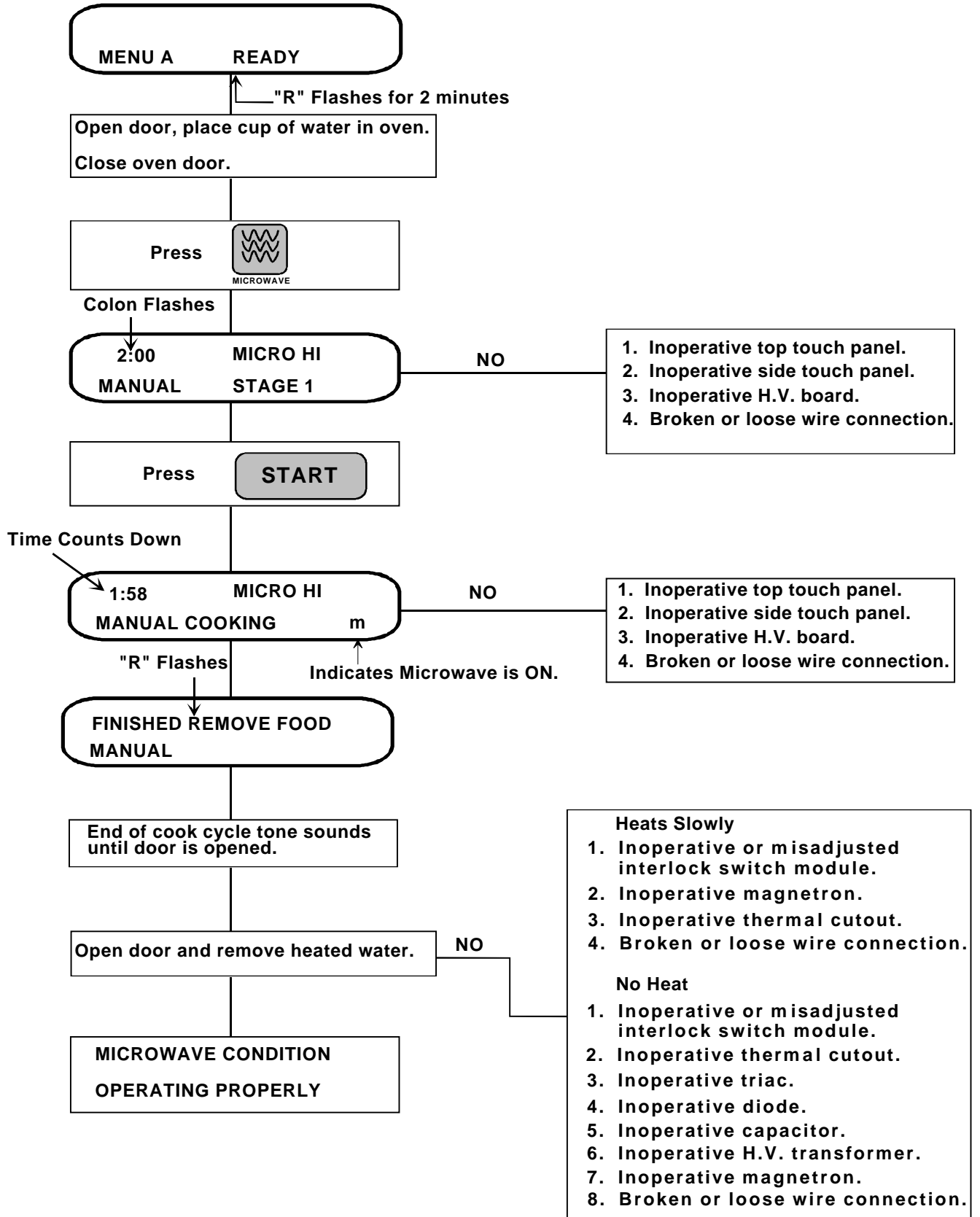

# Troubleshooting

## Preheat Condition

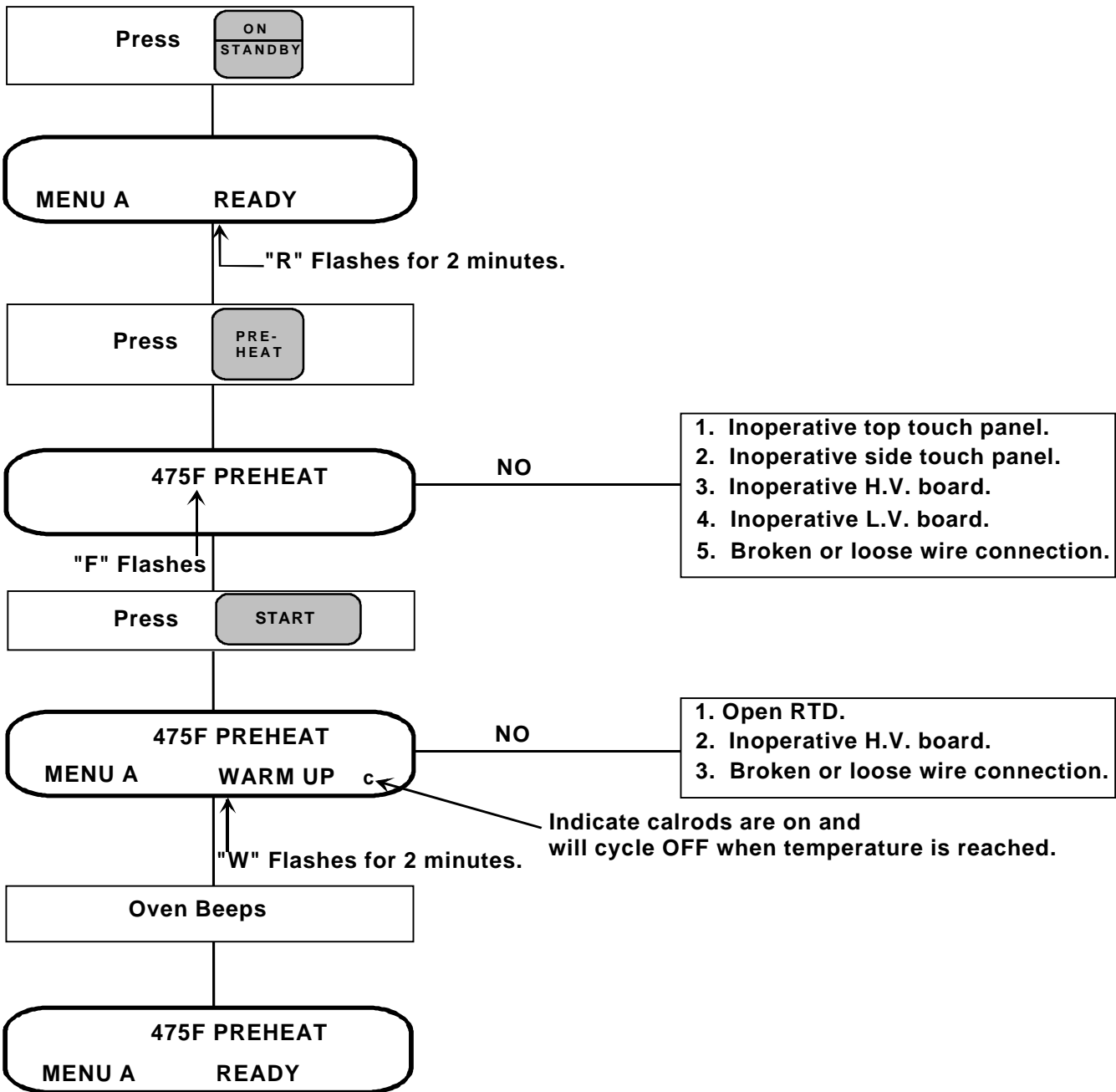



# Troubleshooting

## Convection

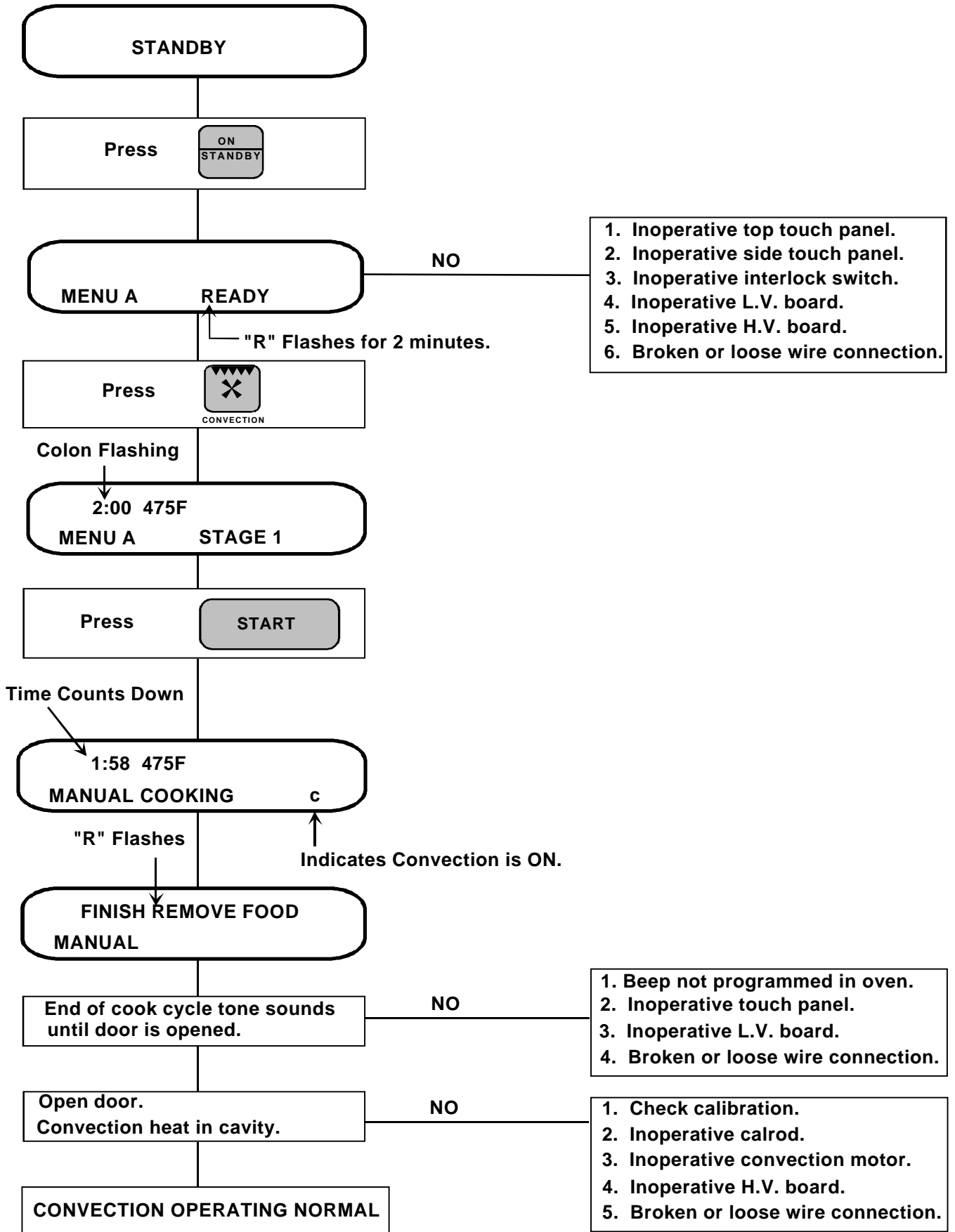

# Disassembly



To avoid the risk of electrical shock, personal injury, or death, disconnect power to oven and discharge capacitors before following any disassembly procedure.

## Door Handle

Door handle is removed by loosening two set screws (3/32 inch allen screws), one located to the left of the door handle and one located on the bottom of the door handle.

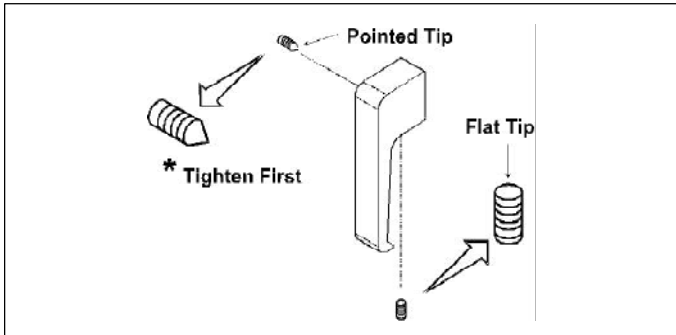

**NOTE:** When replacing door handle, tighten side set screw first.

**NOTE:** If set screws are removed, the set screw with the flat end must be used in the bottom of the door handle.

## Door Glass Retainer / Inner Window Assembly

1. Remove door handle.
2. Remove glass retainer from inner door ring by removing 10 y-drive screws using R0193574 Y-drive tool.
3. Remove inner window.

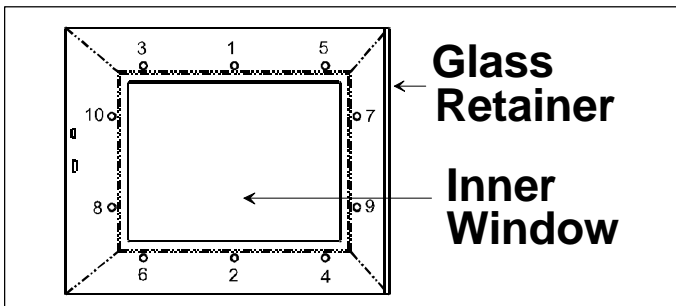

**NOTE:** When reinstalling outer door, tighten screws in pattern as shown above.



## CAUTION

When glass retainer is removed, be careful glass does not fall out of frame.

## Outer Door

1. Remove door handle.
2. Remove door glass retainer/window assembly.
3. Remove outer door.

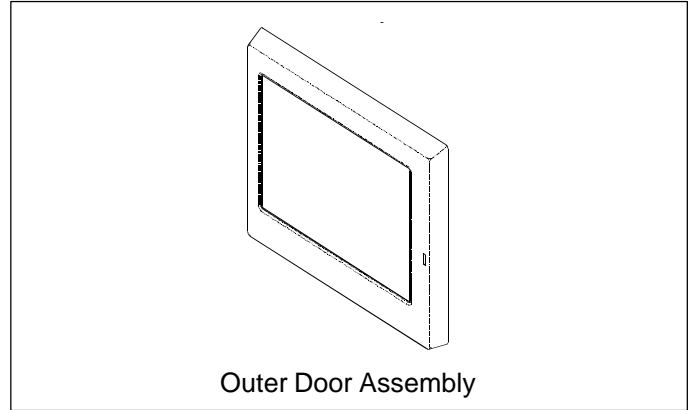

## Inner Door Assembly

1. Remove door handle.
2. Remove retainer/window assembly.
3. Remove choke cover.
4. Remove outer door.
5. Remove hinge screws securing inner door ring assembly.

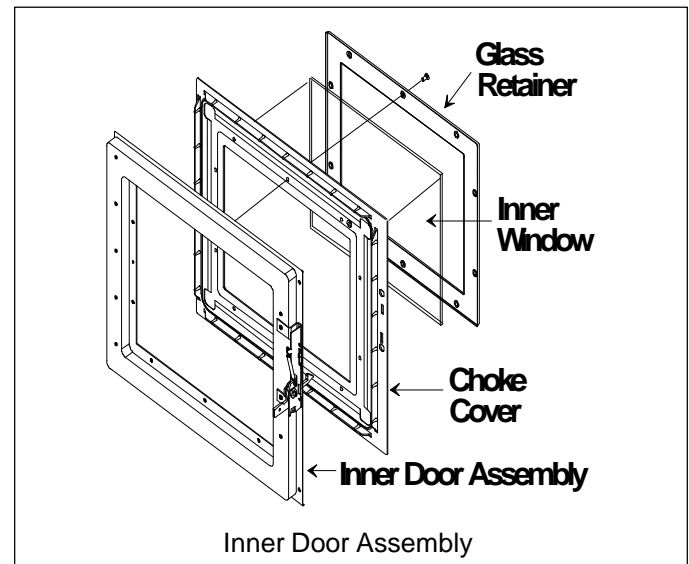

## Choke Cover Removal

1. Remove glass retainer/window assembly.
2. Remove choke cover.

# Disassembly

**WARNING** To avoid the risk of electrical shock, personal injury, or death, disconnect power to oven and discharge capacitors before following any disassembly procedure.

## Hinge

1. Remove outer case.
2. Remove door handle.
3. Remove outer door assembly.
4. Remove hinge mounting screws from hinge (five on front, four on side).

**NOTE:** Discard foam gasket on side of hinge.

5. When reinstalling hinge mounting screws, keep the side screws loose and the front screws tight, close door, press door against oven on the hinge side and tighten side hinge mounting screws in the sequence shown below.

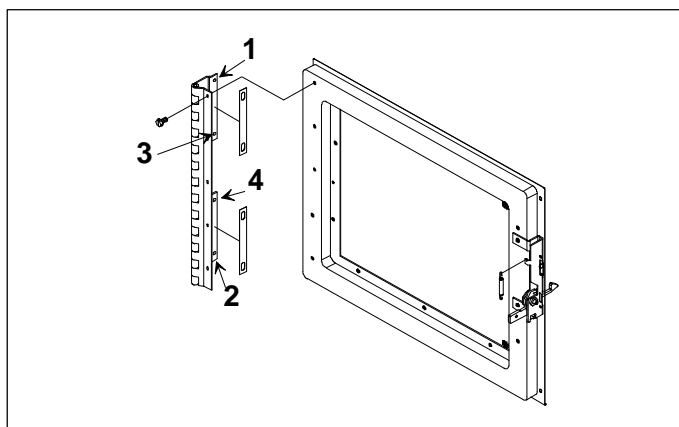

## Outer Case

1. Remove screws securing outer case to chassis, see illustration below.
2. Slide outer case back and lift off.
3. Reassemble outer case in reverse order.

## Back Panel

1. Remove outer case.
2. Remove screws securing back panel.
3. Reassemble back panel in reverse order.

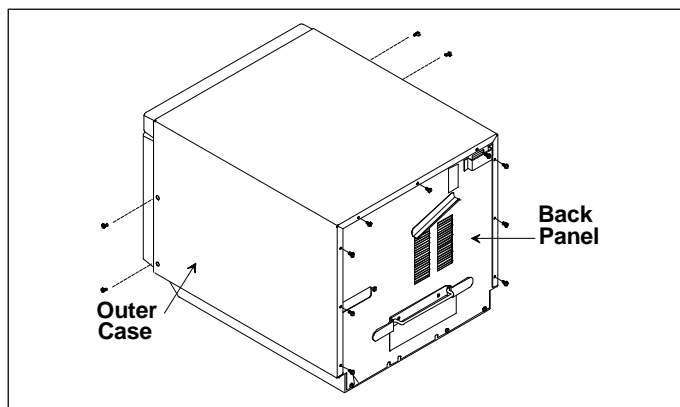

## Stirrer Cover

1. See "Component Location" Figure 4, for location.
2. Unplug oven before removing stirrer cover to access stirrer assembly.
3. Loosen screw securing stirrer cover mounting clip and rotate clip to the side.
4. Slowly lower front of stirrer cover, then pull gently towards front of unit to release cover.
5. Replace stirrer cover by fitting stirrer blade on stirrer insert. Place back of stirrer cover into place, align stirrer insert onto stirrer shaft. Lift front of cover into position, rotate mounting clip into position, tighten screw.

**CAUTION**  
If mounting clip is loose arcing will occur.

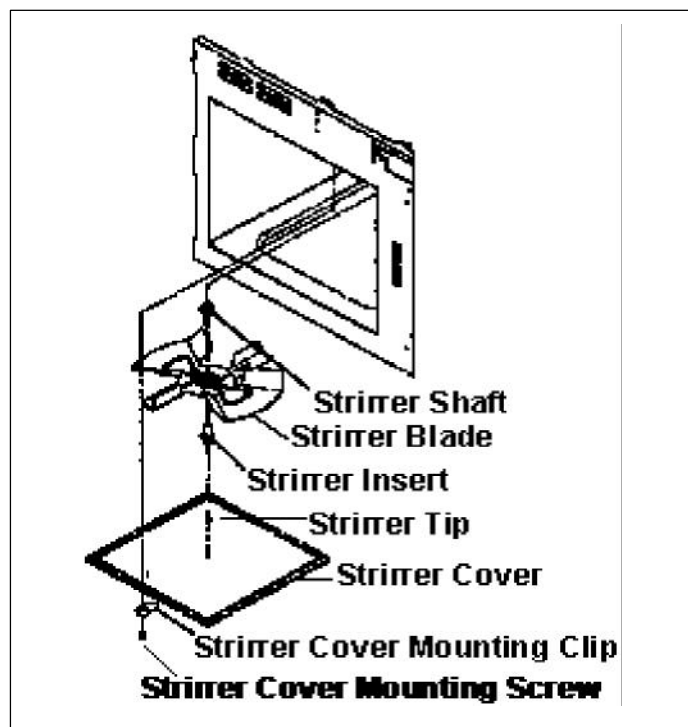

## RTD (Resistance Thermal Device)

1. See "Component Location" Figure 4, for location.
2. Remove outer case.
3. Disconnect RTD harness connector.
4. Remove mounting screw located inside oven.
5. Lift RTD from top of the oven.
6. Reassemble RTD in reverse order.

# Disassembly



**WARNING**

To avoid the risk of electrical shock, personal injury, or death, disconnect power to oven and discharge capacitors before following any disassembly procedure.

## Top Touch Panel Assembly

1. See "Component Location" Figure 1, for location.
2. Remove outer case.
3. Remove ribbon cable from low voltage circuit board.
4. Remove screws securing top touch panel to unit.
5. Reassemble touch panel in reverse order.

**NOTE:** Feed ribbon cable through proper slot and insert into L.V. Board as shown.

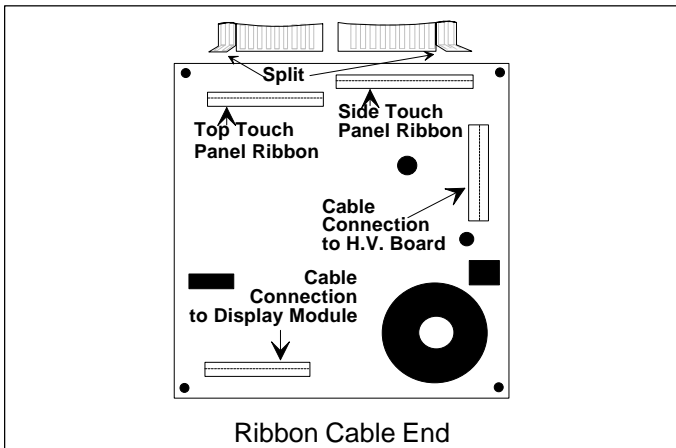

## Low Voltage Circuit Board

1. See "Component Location" Figure 2, for location.
2. Remove outer case.
3. Disconnect ribbon cables.
4. Unclip four standoffs and lift board out.
5. Reassemble low voltage board in reverse order.

**NOTE:** When reassembling, verify cable connection with illustration of cable locations.

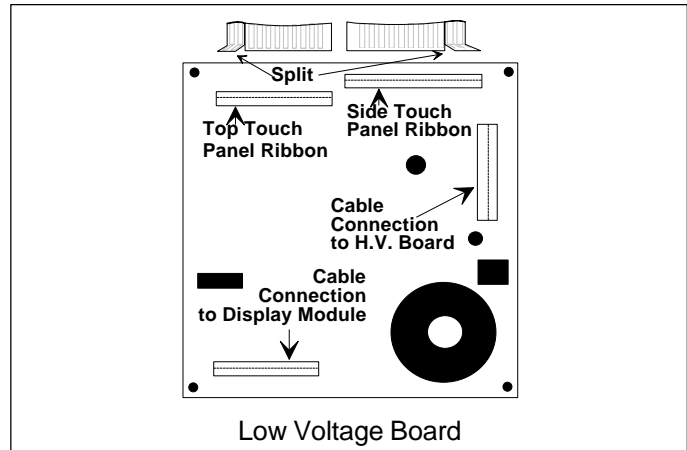

## Side Touch Panel Assembly

1. See "Component Location" Figure 1, for location.
2. Remove outer case.
3. Remove ribbon cable from low voltage circuit board.
4. Remove mounting screws securing side touch panel to unit.
5. Reassemble touch panel in reverse order.

**NOTE:** Feed ribbon cable through proper slot and insert into L.V. Board as shown.

## High Voltage Circuit Board

1. See "Component Location" Figure 2, for location.
2. Remove outer case.
3. Unplug connectors.
4. Disconnect wires from terminals E1, E2, and E3.
5. Disconnect sense loop wire from microwave triac.
6. Disconnect mounting clips and remove board.
7. Reassemble high voltage board in reverse order.

**NOTE:** Be sure to route wire through sensing loop when replacing high voltage board.

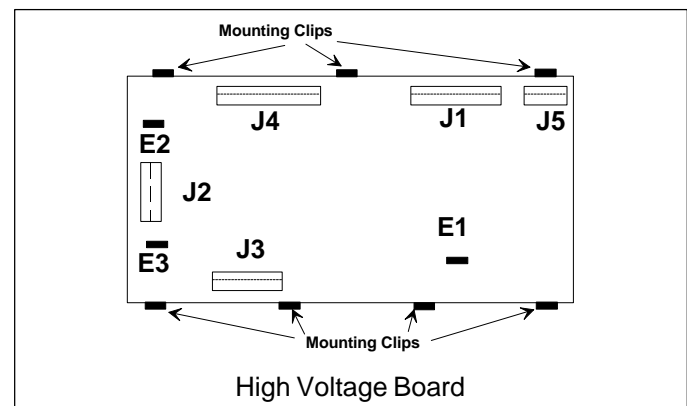

**NOTE:** When reassembling, verify cable connection with illustration of cable locations.

# Disassembly

 <b>WARNING</b>	To avoid the risk of electrical shock, personal injury, or death, disconnect power to oven and discharge capacitors before following any disassembly procedure.
--	---

## Interlock Switch Module

1. See "Component Location" Figure 2, for location.
2. Remove outer case.
3. Disconnect wiring.
4. Remove mounting screws securing switch assembly from oven.
5. Remove two mounting screws on right side of mounting plate, releasing mounting plate from switch assembly.
6. When replacing module, all wires must be connected before operating oven.

**NOTE:** When the line fuse is blown **interlock switch module** must be replaced.

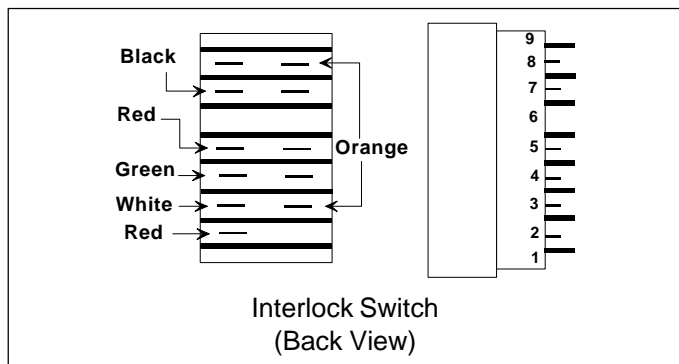

## Adjustment

1. To adjust interlock switch assembly, close door.
2. Loosen bottom screw on the interlock switch assembly, allowing switch assembly to move in or out.
3. With door closed, push forward on interlock assembly to engage door latch. Then pull back on interlock assembly until door is "snug" against front oven cavity and tighten bottom screw first, then top screw.
4. Door will remain latched when proper adjustment is made.

**NOTE:** If door is not properly adjusted display will indicate *DOOR OPEN* when the door is closed.

## Display Module

1. See "Component Location" Figure 2, for location.
2. Remove outer case.
3. Remove top touch panel.
4. Remove wire plug connected to display module.
5. Remove screws and spacers securing display module.
6. Reassemble display module in reverse order.

## Magnetron

1. See "Component Location" Figure 1 and 2, for location.
2. Remove outer case.
3. Remove screws securing magnetron inlet cover and remove cover.
4. Remove screws securing front magnetron cover.
5. Remove wires from magnetron.
6. Remove allen screws securing magnetron thermal cutout bracket to magnetron.
7. Remove magnetron mounting nuts and remove front magnetron cover bracket..
8. Remove magnetron.
9. When replacing magnetron, verify wire mesh gasket is reinstalled properly.

**NOTE:** When reinstalling magnetron, slide air baffle inside magnetron before mounting magnetron in place.

**NOTE:** Place front magnetron cover bracket in place before securing magnetron.

## Magnetron, Control, and Fan Thermal Cutout (TCO)

1. See "Component Location" Figure 3, for location.
2. Remove outer case.
3. Remove wiring from selected thermal cutout.
4. Remove screws securing thermal cutout.
5. Reassemble thermal cutout in reverse order.

## Triacs

1. See "Component Location" Figure 1, for location.
2. Remove outer case and back panel.
3. Remove wires from terminals of selected triac.
4. Remove screws securing triac to chassis.
5. Reassemble triac in reverse order.

# Disassembly



## WARNING

To avoid the risk of electrical shock, personal injury, or death, disconnect power to oven and discharge capacitors before following any disassembly procedure.

### Microwave Blower Wheel and Motor

1. Remove outer case and back panel.
2. Remove wiring from blower motor terminals.
3. Remove screws securing blower assembly to bracket.
4. Remove assembly from oven.
5. Loosen allen set screw securing blower wheel to motor shaft.
6. Remove blower wheel.
7. Remove screws securing motor to scroll.
8. Reassemble blower wheel and motor in reverse order.

**NOTE:** When reinstalling blower wheel, push blower wheel on shaft, tighten, and rotate to insure clearance between blower wheel, and blower housing.

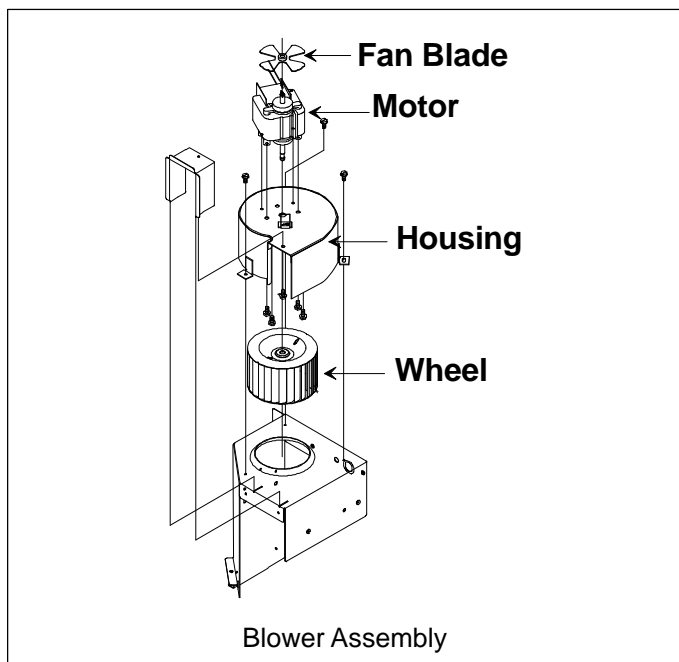

### Fan Blade

1. Pull blade off shaft.
2. When reinstalling blade, push blade on shaft and rotate to insure clearance between fan blade and motor mounting bolt.

### Auto Transformer

1. See "Component Location" Figure 2, for location.
2. Remove outer case and back panel.
3. Remove screws securing auto transformer to blower duct.
5. Remove wire connections from auto transformer.
6. Reassemble auto transformer in reverse order.

### Transformer

1. See "Component Location" Figure 3, for location.
2. Remove outer case and back panel.
3. Remove screws securing transformer to chassis.
4. Pry upward and back to release transformer from chassis.
5. Remove wire connections from transformer.
6. Reassemble transformer in reverse order.

### Capacitor

1. See "Component Location" Figure 2, for location.
2. Remove outer case and back panel.
3. Discharge capacitor and remove wires from terminals.
4. Remove capacitor bracket mounting screw.
5. Reassemble capacitor in reverse order.

**NOTE:** Capacitor case must be installed into indent in back panel.

### Heater Box

1. See "Component Location" Figure 3, for location.
2. Remove outer case and back panel.
3. Remove wires connected to heating elements, convection fan, and control thermal cutout.
4. Remove screws securing heater box.
5. Slide heater box sideways from chassis.
6. Reassemble heater box in reverse order.

### Heating Elements

1. See "Component Location" Figure 5, for location.
2. Remove outer case and back panel.
3. Remove heater box.
4. Remove screws securing heater assembly to heater box.
5. Reassemble heating element in reverse order.

**NOTE:** Center heating element around convection fan blade.

# Disassembly

 <b>WARNING</b>	To avoid the risk of electrical shock, personal injury, or death, disconnect power to oven and discharge capacitors before following any disassembly procedure.
--	---

## Convection Fan and Motor

1. See “Component Location” Figure 5, for location.
2. Remove outer case and back panel.
3. Remove heater box.
4. Remove left handed threaded nut on fan blade, and slide fan off.
5. Remove screws securing convection motor to heater box.
6. Reassemble convection motor in reverse order.

## Fuse

1. See “Component Location” Figure 2, for location.
2. Remove outer case.
3. Replace fuse and reassemble in reverse order.

## Power Cord

1. See “Component Location” Figure 3, for location.
2. Remove outer case and back panel.
3. Disconnect wiring.
4. Remove strain relief by compressing with pliers.
5. Remove power cord.
6. Reassemble power cord in reverse order.

## Light Socket

1. Remove outer case.
2. Remove screws securing lamp cover bracket.
3. Unscrew light bulb from socket.
4. Disconnect wire terminals to light socket.
5. Remove screw securing light socket to light retainer.
6. Reassemble light socket in reverse order.

## Replacing Oven Light Bulb

 <b>WARNING</b>
To avoid electrical shock which can cause severe personal injury or death, unplug power cord or open circuit breaker to oven before replacing light bulb. After replacing light bulb, restore power.

 <b>CAUTION</b>
To avoid personal injury or property damage, observe the following: <ul style="list-style-type: none"><li>• Allow oven and light bulb to cool.</li><li>• Wear gloves when replacing light bulb.</li></ul>

## Tools Needed

- Protective gloves
- Phillips screwdriver
- 40-watt, 250-volt appliance bulb (available from authorized distributor or servicer)

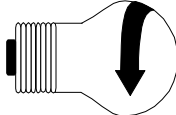
	To remove bulb, turn in direction shown.
---	--

1. Remove screw from access cover on top left wall of oven exterior. Remove access cover.
2. Remove old bulb and replace with new bulb.
3. Replace access cover and screw by reversing procedure in step 1.

# Disassembly



**WARNING**

To avoid the risk of electrical shock, personal injury, or death, disconnect power to oven and discharge capacitors before following any disassembly procedure.

## Component Location

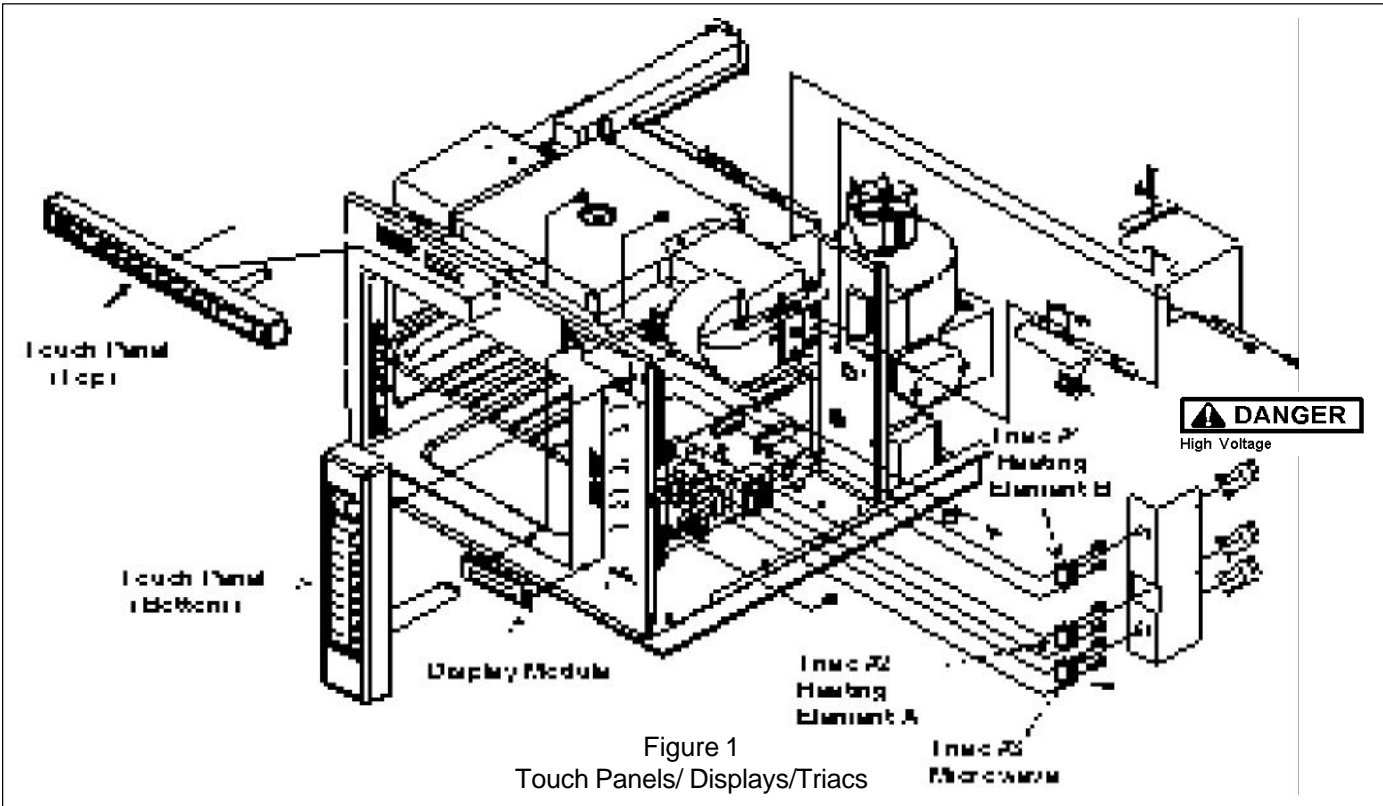

Figure 1  
Touch Panels/ Displays/Triacs

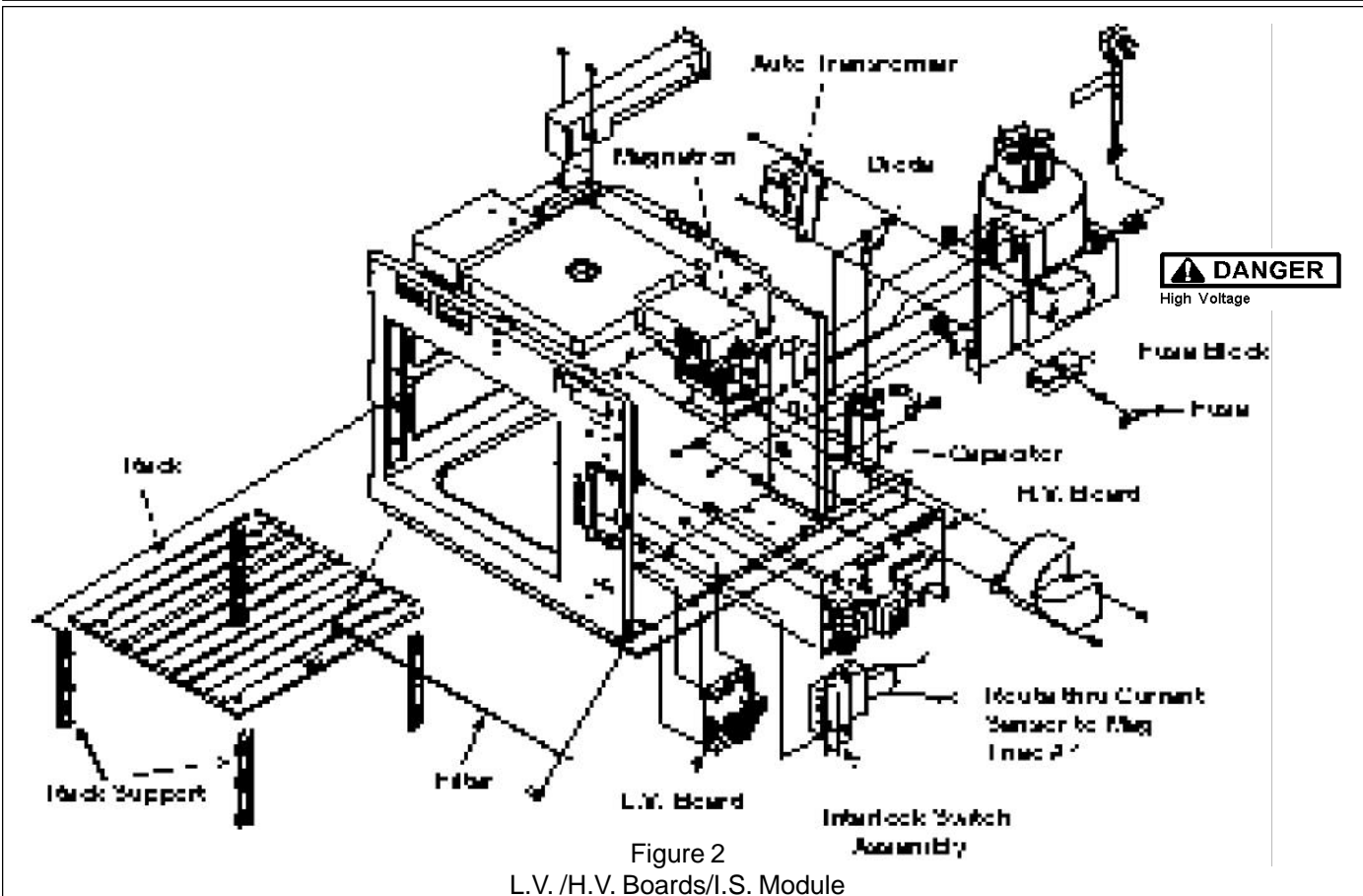

Figure 2  
L.V./H.V. Boards/I.S. Module



# Disassembly

**WARNING** To avoid the risk of electrical shock, personal injury, or death, disconnect power to oven and discharge capacitors before following any disassembly procedure.

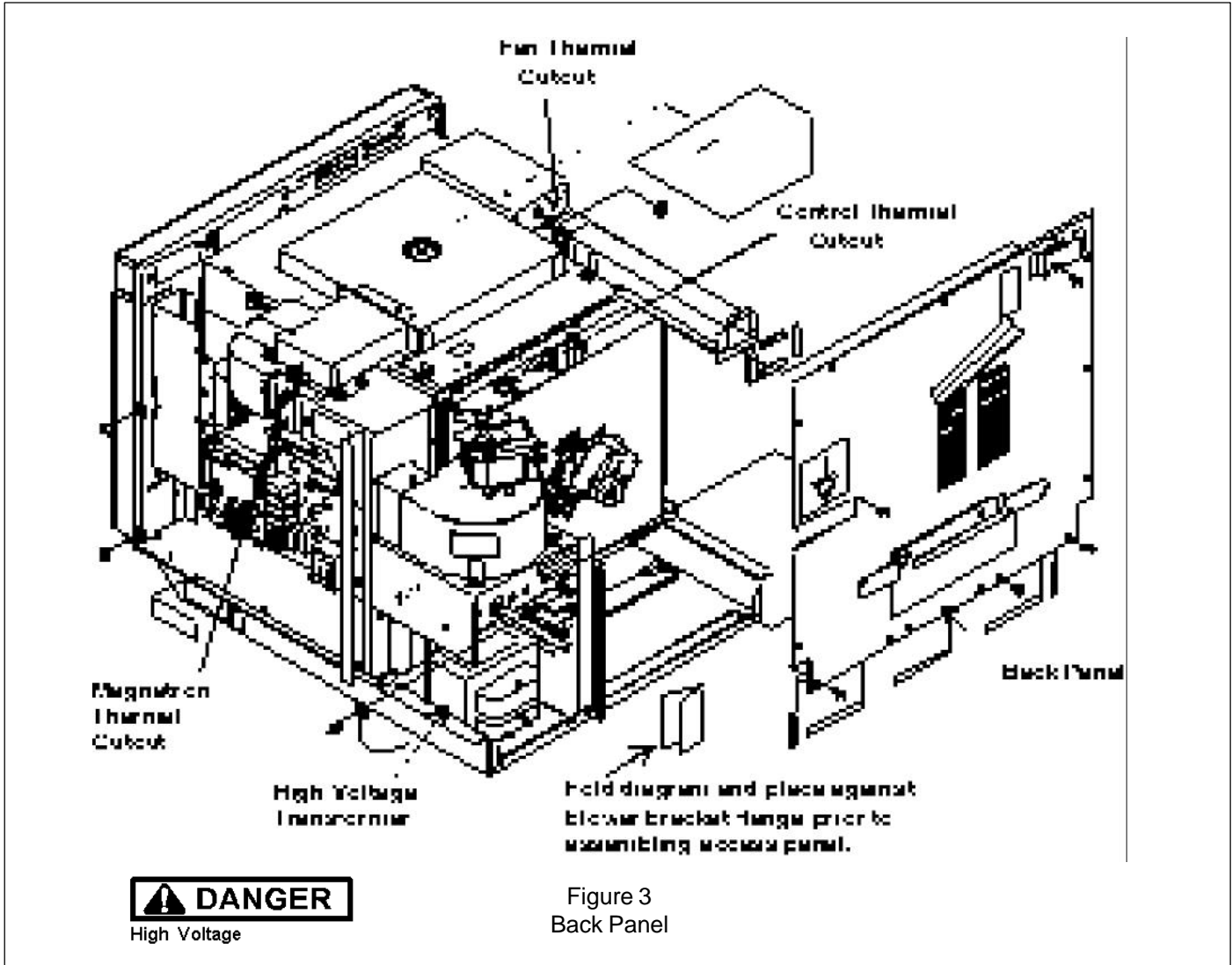

Figure 3  
Back Panel

# Disassembly

**WARNING** To avoid the risk of electrical shock, personal injury, or death, disconnect power to oven and discharge capacitors before following any disassembly procedure.

