



Service manual: Tumble Dryers

Type: TD60

Contents	
Updates.....	3
Introduction	4
Product overview.....	5
Programme selection, options and making settings TD60.3.....	8
Programme selection TD60.3	9
Selecting Options TD60.3	10
Making settings TD60.3	12
Programme selection, options and making settings TD60.2.....	14
Select program and making options TD60.1	15
Service menu TD60.3.....	16
Service menu TD60.2.....	19
Service menu TD60.1	20
Fault indications TD60.3.....	21
Fault indications TD60.2.....	22
Fault indications TD60.1	23
Heater 2 activation TD60.3	25
Heater 2 activation TD60.2	25
Heater 2 activation TD60.1	25
Shop programme TD60.3.....	26
Shop programme TD60.2 and TD60.1	26
Components and measurement values TD60.....	27
Technical data.....	28
Wiring diagram TD60.3.....	29
Wiring diagram TD60.2.....	30
Wiring diagram TD60.1	31
Rehanging the door.....	32
Replacing panel.....	35
Timer diagram.....	36

This service manual describes tumble dryer type TD60 and is a supplement to the general service manual for the 600 series.



Updates

Revision	Date	Description	Signature
03	2007-11-27	Updated the "Show room program" /Shop program with a description for machines manufactured week 737 and later.	BPA
04	2008-10-16	Updated with TD60.2. TD60.3 added Jeans and Synthetics program	MW
05	2010-04-29	Updated with TD60.1	MAS

Introduction

You are holding the service manual for TD60 type tumble dryers.

It should be easy to service a tumble dryer. It is important that you, as a service technician, are given the conditions to be able to carry out work in an efficient and satisfactory way. Our hope is that this service manual is a useful tool for your daily work.

The type designation can be found on the machine plate located by the door catch on the inside of the front plate. (see image below)

Asko Appliances AB
SE-534 82 Vara
Sweden

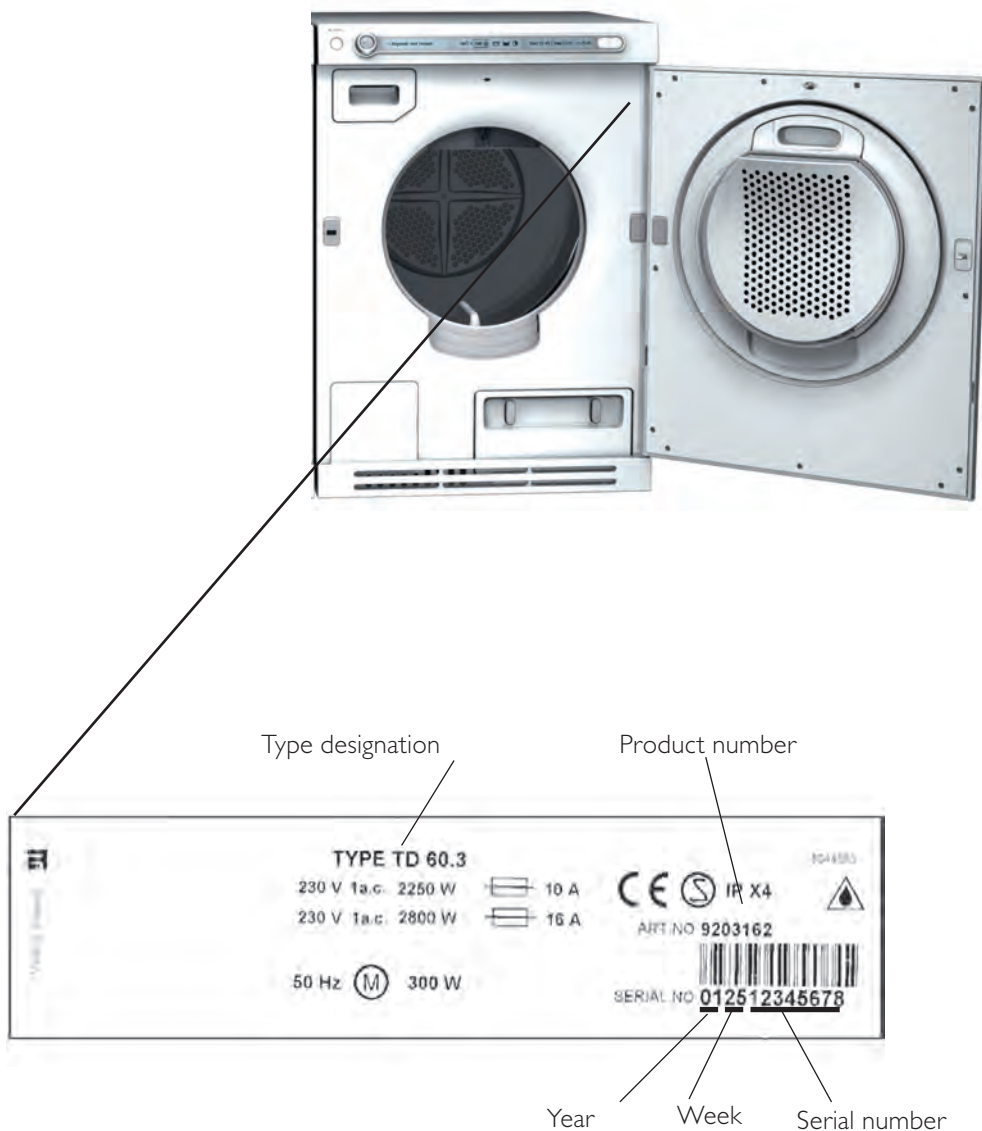

Product overview

TD60.3

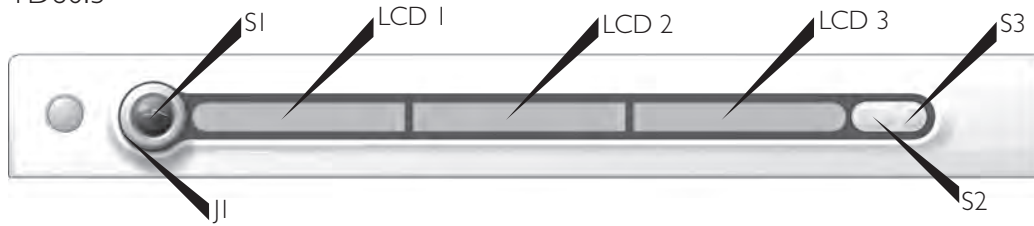

Positions: 8, where one consists of the menu for settings (Position 7)

Options: 5

Settings: 4

TD60.3 (Integrated)

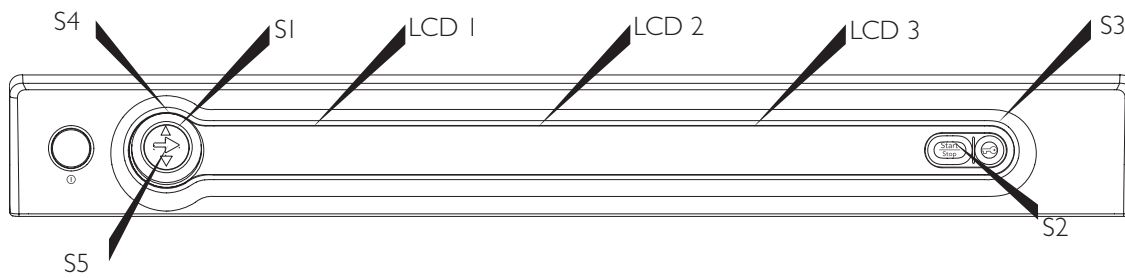

Positions: 8, where one consists of the menu for settings (Position 7)

Options: 5

Settings: 4

TD60.2

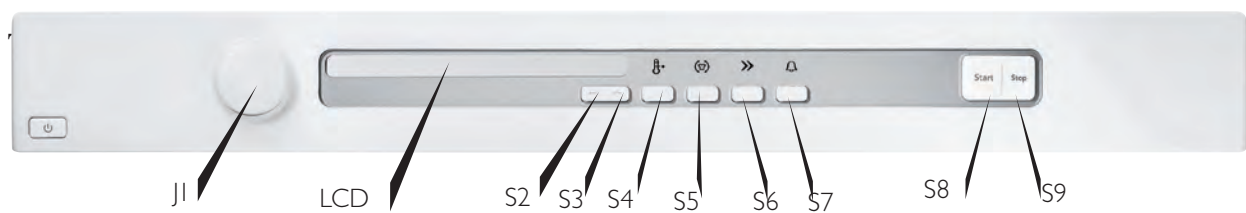

Positions: 6

Options: 4

Settings: 1

TD60.I, Panel type 1

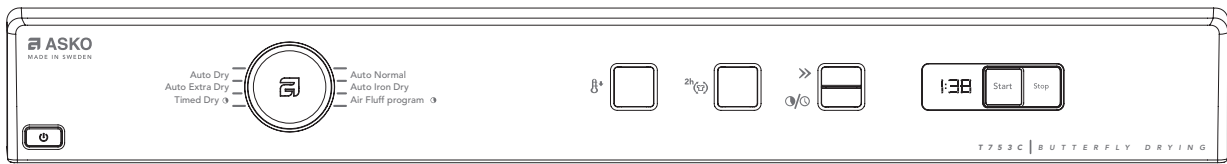

Program: 6
Options: 4
Settings: 1

TD60.I, Panel type 2



Program: 4
Options: 2
Settings: 1

Programme table TD60

Programmes	Material	Temperature	Max. load (kg)	Energy consumption (kWh)		Programme time	
				800 rpm	1600 rpm	800 rpm	1600 rpm
Extra dry	Cotton, linen	Normal	7	5.4	4.2	160	130
Dry	Cotton, linen	Normal	7	4.6	3.6	140	110
Normal dry*	Cotton, linen	Normal	7	4.3	3.3	130	100
Iron dry	Cotton, linen	Normal	7	3.5	2.6	105	80
Jeans	Jeans, clothing with thick seams	Normal	-	-	-	-	-
Synthetic	Permanent press, polyester/cotton	Low	-	-	-	-	-
Timed dry	All types	Low	-	-	-	-	-
Air fluff programme	All types	Low	-	-	-	-	-

* This programme has been tested in accordance with EN 611 21/95/13/EEC.

Here we present a few examples of the energy and time consumption of a few different programme settings. Consumption can vary according to room temperature, humidity, load, variations in the power supply and selected options.

The following apply for the specified consumption values:

Temperature of intake air: 23°C

Moisture content of intake air: 55%

Drying temperature: Normal or low

Heater output: 3000 W



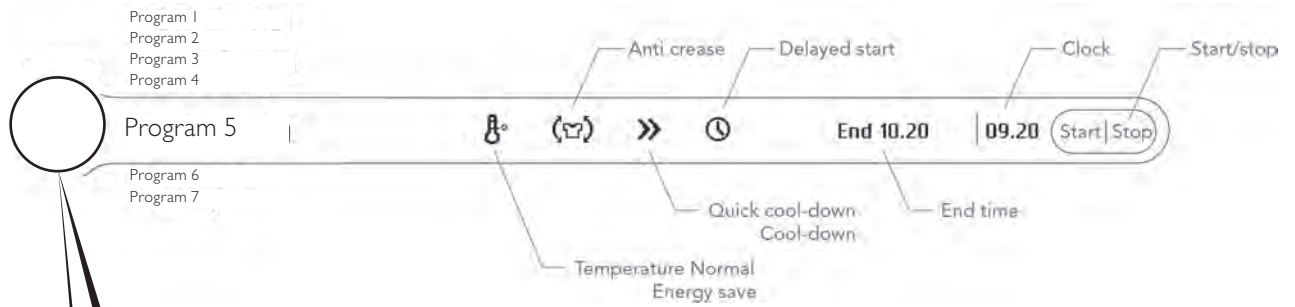

Programme selection, options and making settings TD60.3



Program selector	
<p>2</p> <p>3</p> <p>Start Stop</p>	<ol style="list-style-type: none"> 1. Press the program selector button to navigate between the different menus (e.g. to go from temperature menu to Anti Crease menu). 2. Turn the program selector button to make a selection in the menus (e.g. select normal temp.). Confirm the selection and go to the next menu by pressing the program selector button. 3. Press Start to start. Hold Stop in for 3 seconds to exit the current program.
Program selector for integrated machines	
<p>2</p> <p>2</p> <p>3</p> <p>Start Stop</p>	<ol style="list-style-type: none"> 1. Press the program selector button to navigate between the different menus (e.g. to go from temperature menu to Anti crease menu). 2. Press the small arrows to make a selection in the menus (e.g. select normal temp.). Confirm the selection and go to the next menu by pressing the program selector button. 3. Press Start to start. Hold Stop in for 3 seconds to exit the current program.





















Programme selection TD60.3

The programs are displayed in the order they occur in LCD I. All display text language versions are displayed.





Press/ turn	Pos.	LCD I	Comments/instructions
		Turn on the main power supply	
	1	Extra Dry, Heavy, Auto extra dry, Auto extra-torr, Ekstra tørt, Auto ekstra tørt, Erittäin kuiva, Séchage intensif, Extra droog, Perfett. asc. autom., Secado pesado auto, Экстра сушка, Extratrocken	This programme is for items that are particularly difficult to dry, e.g. jeans with very thick seams.
	2	Dry, Normal, Auto dry, Auto skåptorr, Skabstørt, Auto tørt, Kaappikuiva, Séchage armoire, Kastdroog, Asc. da riporre autom., Sec. para armario auto, Нормальная сушка, Schranktrocken	This programme shut off the heat once the load is dry but before it is "bone-dry". The program on position 2 shuts off the heat slightly later than the program on position 3. Use trial and error to find out what works best. Use these programs when you want items to be completely dry.
	3	Normal Dry, Delicate, Auto normal dry, Auto normaltørt, Normalt tørt, Auto nesten tørt, Normaalkuiva, Séchage normal, Normaal droog, Asciutto norm. autom., Secado liviano auto, Деликатная сушка, Normaltrocken	This programme shut off the heat once the load is dry but before it is "bone-dry". The program on position 3 shuts off the heat slightly later than the program on position 4. Use trial and error to find out what works best. Use these programs when you want items to be completely dry.
	4	Iron Dry, Iron Dry, Auto Iron dry, Auto stryketørt, Strygetørt, Auto stryketørt, Silityskuiva, Repassage, Strijkdroog, Asc. da stirare autom., Sec. para plancha auto, Сушка "под утюг", Bügeltrocken	This programme shuts off the heat once the load is just damp enough for ironing or pressing.
	5	Jeans, Jeans, Jeans, Denim, Jeans, Farkut, Jeans, Jeans, Jeans, Vaqueros, Джинсы, Jeans	Special designed programme for jeans and rough cotton with thick seams. Normal temperature which not can be changed
	6	Synthetic, Synthetics, Syntet, Syntetisk, Syntet, Syn-teettiset, Synthétique, Synthetik, Sintetici, Sintético, Синтетика, Synthetica	Special designed programme for delicate material. Low temperature which not can be changed
	7	Timed Dry, Timed Dry , Timed dry , Tidsprogram, Tidsprogram, Tidsprogram, Aikaohjelma, Programme minute, Tijdprogramma, Progr. del tempo , Prog. de secado, Сушка по времени, Zeitprogramm	The programme length you choose depends on what you intend to do with the items after drying them. Use trial and error to find out what works best. When you use Timed dry to tumble-dry a load of mixed fabrics, some of the garments may remain damp. Tumble-dry any damp garments for a further 30 minutes or so using the Timed dry program When using the Timed dry program, garments can become "over-dry" if you have selected too long a drying time. This can cause the items to shrink or crease and become rough. Synthetic materials can also become charged with static electricity. Set the number of minutes incrementally. The selected time is shown on the display. Try out different drying times.
	8	Air Fluff, Air Fluff , Revitalise, Luftningsprogram, Koldluftprogram, Kald luft, Tuuletus, Ventilation, Ventilieren, Arieggiamento, Aireado, Проветривание, Lüften	Use the Revitalise programme when you just want to refresh, air or soften up items Set the number of minutes incrementally. The selected time is shown on the display. Try out different drying times.
	9	Settings, Settings, Settings, Inställningar, Indstillinger, Instillinger, Asetukset, Réglage, Instellingen, Impostazioni, Ajustes, Настройки, Einstellungen	
			Exits the programme menu and advances to options or the menu for Settings.

Selecting Options TD60.3

The options are displayed in the order they occur in LCD2 and LCD3. All display text language versions are displayed.



















Press/turn	LCD 2	LCD 3	Comments/instructions
 		Temperature Normal, Temperature normal, Temperatur normal, Temperatur normal, Lämpötila normaali, Temp. normal, Normale temperatuur, Temp. normale, Temperatura normal, Норм. температура, Temp. normal	Two possible choices of temperature. Not available for program at programme 6 ("Air Fluff")
		Temperature Low, Energy Save, Temperatur låg, Temperatur lav, Temperatur lav, Lämpötila matala, Temp. faible, Lage temperatuur, Temp. bassa, Baja temperatura, Низкая температура, Temp. niedrig	
			
 		Anti Wrinkle On, Anti crease On, Skrynkelfritt På , Anti-krøl Til , Antikrøll På, Rypistymisen esto Päällä, Antifroissage On, Anti-kreuk Aan, Antisgualcit. On, Antiarrugas encendido , Против сминания Вкл., Knitterschutz An	<p>This is a useful feature if you cannot take the washing out as soon as the tumble dryer has finished.</p> <p>The function prevents the clothes from remaining in the same position and becoming creased. The drum will rotate for three seconds per minute for two hours once the drying program has finished</p> <p>Not available for programme at position 6 ("Air Fluff")</p>
		Anti Wrinkle Off, Anti crease Off, Skrynkelfritt Av, Anti-krøl Fra , Antikrøll Av , Rypistymisen esto Poissa, Antifroissage Off, Anti-kreuk Uit, Antisgualcit. Off, Antiarrugas apagado, Против сминания Выкл., Knitterschutz Aus	
			
 		Time saver, Tidsbesparing, Ekspres tørring, Reduser programtid, Express, Rapide, Tijdbesparing, Turbo Tiempo, Ускоренная, Express	<p>The programme is shortened by about 12 minutes.</p> <p>The option cannot be selected for the Air fluff program.</p> <p>The option cannot be selected for the Air fluff program.</p>
		Time saver off, Tidsbesparing av, Ekspres tørring fra, Reduser programtid av, Express poissa, Rapide off, Tijdbesparing uit, Turbo off, Tiempo apagado, Ускоренная Выкл., Express aus	
			
 		Start, Start, Start, Start, Start, Start, Start, Démarrer, Start, Avvio, Inicio, Старт, Start	<p>Delayed start (when setting: "No Real time")</p> <p>The start of the selected programme can be delayed for up to 24 hours (in half an hour intervals). The delay and program time is shown in the display.</p> <div style="border: 1px solid gray; padding: 2px; display: inline-block;">  Start: 1:00 2:35 </div> <p>Delayed start (when setting: "24 Hour Clock " or "12 Hour Clock")</p> <p>The start of the selected programme can be delayed for up to 24 hours (in half an hour intervals). Start and end times are shown in the display.</p> <div style="border: 1px solid gray; padding: 2px; display: inline-block;">  Start 16:22 Done 18:00 15:52 </div>
	(Option for all programmes except Timed dry)		

Selecting Options TD60.3











		<p>Start - Done, Start-End, Start-Done, Start-Klar; Start-Færdig, Start-Ferdig, Start-Valmis, Démarrer-Fin, Start-Fertig, Avvio-Fine, Inicio-Fin, Старт-Конец, Start-Gereed</p> <p>(Option only for Timed dry)</p>	<p>Time program (when setting: "No Real time") Desired programme time can be set. Selections up to 3 hours in units of 15 minutes can be made. The selected program time is shown in the display.</p>  <p>Time program (when setting: "24 Hour Clock" or "12 Hour Clock") Desired programme time can be set. Selections up to 3 hours in units of 15 minutes can be made. Start and end times are shown in the display.</p> 
---	---	--	--

Making settings TD60.3

The setting options below are shown in the order they occur in LCD2 (Position 7 under the program menu is, however, shown in LCD1). All display text language versions are displayed.

Press/turn	LCD 2	Press/turn	LCD3	Comments/instructions
 	Settings, Settings, Settings, Inställningar, Indstillinger, Innstillinger, Asetukset, Réglage, Einstellungen, Impostazioni, Ajustes, Настройки, Instellingen			In the programme menu: Scroll to program 9 (Settings)
	You will now enter the Settings menu.			
 	1 Clock/Auto Start, 1 Clock, 1 Klocka, 1 Ur, 1 Klokke, 1 Kello, 1 Horloge, 1 Klok, 1 Orologio, 1 Reloj, Часы, 1 Uhr			
			24hr Realtime, 24 Hour Clock, 24hr Realtime, 24 timmarsvisning, 24 timers ur, 24t realtid, 24 h aika, Horloge 24 h, 24 Std. Echtzeit, 24h Tempo reale, Reloj 24 horas, Формат времени 24-ч., 24 uur weergave	Three O'clock is displayed as "15.00". Press SI to access a sub-menu where you can set the correct current time. Press SI again to store and exit the sub-menu.
			12hr Realtime, 12 Hour Clock, 12hr Realtime, 12 timmarsvisning, 12 timers ur, 12t realtid, 12 h aika, Horloge 12 h, 12 Std. Echtzeit, 12h Tempo reale, Reloj 12 horas, Формат времени 12-ч., 12 uur weergave	Three O'clock is displayed as "03.00". Press SI to access a sub-menu where you can set the correct current time. Press SI again to store and exit the sub-menu.
			No Real time, No Real Time, No Real time, Ej realtid, Intet ur, Ingen realtid, Ei aikka, Pas d'horloge, Keine Echtzeit, No tempo reale, Sin hora real, Время не установлено, Geen tijdsweergave	No Real Time. Press SI to return to program menu.
			Saves the setting and returns to the program menu.	
 	2 Buzzer Volume, 2 Audible Volume, 2 Ljudsignal, 2 Lydsignal, 2 Lydsignal, 2 Hälytysääni, 2 Volume buzzer, 2 Volume eindsignaal, 2 Volume allarme, 2 Volumen timbre, Громкость сигнала, 2 Tonsignal			
			Off, Off, Off, Av, Fra, Av, Poissa, Off, Aus, Off, apagado, Выкл., Uit	No buzzer
			Low, Low, Low, Låg, Lav, Lav, Matala, Faible, Niedrig, Bassa, Bajo, Низкая, Laag	Buzzer that indicates the end of a program or error.
			Normal, Normal, Normal, Normal, Normal, Normal, Normaali, Normal, Normal, Normale, Normal, Нормальная, Normaal	Buzzer that indicates the end of a program or error.
			High, High, High, Hög, Høj, Høy, Korkea, Elevé, Hoch, Alta, Alto, вод, Hoog	Buzzer that indicates the end of a program or error.
	Saves the setting and returns to the program menu.			

Making settings TD60.3

Press/ turn	LCD 2	Press/ turn	LCD3	Comments/instructions	
 	3 Language, 3 Language, 3 Språk, 3 Sprog, 3 Språk, 3 Kieli, 3 Langue, 3 Taal, 3 Lingua, 3 Idioma, Язык, 3 Sprache				
			US English AU English (default) Svenska Dansk Norsk Suomi Francais Nederlands Italiano Espanol Русский Deutsch		
					
			Saves the setting and returns to the program menu.		
	4 Child-safe, 4 Child-safe, 4 Barnsäker, 4 Børnesikker, 4 Barnesikring, 4 Lapsilukko, 4 Sécurité enfant, 4 Kindveilige, 4 Avvio sicurezza, 4 Int. de seguridad, 4 Блокировка, 4 Kindersicherung				
			On, On, On, På, Til, På, Päällä, On, An, On, encendido, Вкл., Aan	If S1, S2, S3 or J1 are pressed or turned, Start S2 + S1 must be pressed to temporarily deactivate the child-safe start (is deactivated for 3 minutes after).	
			Off, Off, Off, Av, Fra, Av, Poissa, Off, Aus, Off, apagado, Выкл., Uit	Setting deactivated.	
			Saves the setting and returns to the program menu.		
		5 Return, 5 Return, 5 Return, 5 Tillbaka, 5 Tilbage, 5 Tilbake, 5 Takaisin, 5 Retour, 5 Zurück, 5 Uscire, 5 Salir, 5 Назад, 5 Terug		Return to the program menu	

Programme selection, options and making settings TD60.2

Program 1





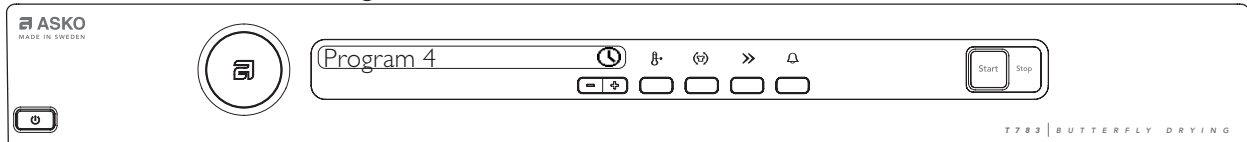

Program 2

Program 3



Program 5

Program 6

Press	Options	Comments/instructions
 	<ul style="list-style-type: none"> • Normal / low temperature 	<p>Temperature</p> <p>Two possible choices of temperature.</p>
	<ul style="list-style-type: none"> • The programme is shortened by about 12 minutes. 	Time saver
	<ul style="list-style-type: none"> • The drum will rotate for three seconds per minute for two hours once the drying program has finished 	Anti-crease
	<ul style="list-style-type: none"> • The start of the selected program can be delayed for up to 24 hours 	Delayed Start
	<ul style="list-style-type: none"> • Buzzer that indicates the end of a program or error. 	Audible Volume, Buzzer
	Settings	Comments/instructions
	<ul style="list-style-type: none"> • Turn off the machine using the main power switch. • Press Main power switch and Start/Stop button • Turn the program selector and choose language. • Press Start/Stop button to store. 	Language
	<ul style="list-style-type: none"> • Turn off the machine using the main power switch. • Press + button and Temperature button • Turn the program selector and choose on or off. • Press Start/Stop button to store. 	Child-safe

Selecting programme and making options TD60. I

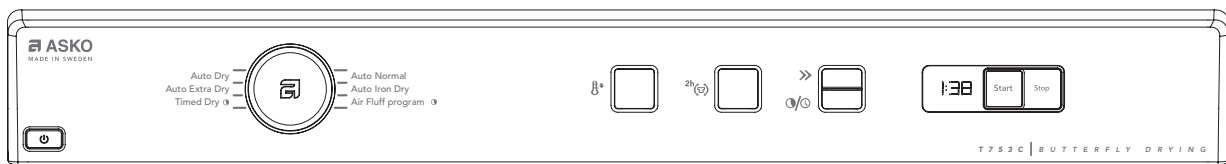



Turn the program selector to select a program. See the program table below.

Program	Program description and type of fabrics
1. Auto Extra dry	Program for fabrics that are especially difficult to dry.
2. Auto Dry	These programs end automatically when the load is dry. The Auto Dry programme gives slightly drier laundry than Auto Normal dry.
3. Auto Normal dry	
4. Auto Iron dry	This programs ends when the load is just damp enough for ironing or mangling.
5. Timed dry 1)	Select the program length according to what you intend to do with the items after drying them.
6. Air fluff programme 1)	For items that simply need to be freshened up, aired or softened.
1 Only machines with panel type I	

Press the option buttons to select options. See the options table below.

Press	Options	Comments/instructions
	<ul style="list-style-type: none"> • Temperature low 	You can select low temperature with all program except Air fluff.
	<ul style="list-style-type: none"> • Time saver 1) 	The program is shortened by about twelve minutes. Time saver can be selected with all programmes except Air fluff.
	<ul style="list-style-type: none"> • Anti-crease 	If you are not able to remove the load immediately you can select the Anti-crease option. The drum rotates for three seconds per minute for two hours once tumble drying has finished. This prevents the fabrics from lying still and becoming creased.
	<ul style="list-style-type: none"> • Delayed start 1) 	<p>Choose the number of hours that you want to delay the start by. You can delay the start by between 1 and 24 hours. The option cannot be used with the Timed dry and Air fluff programmes.</p> <p>First select which programme you want to use.</p> <p>Press the + button below the symbol in the display to select Delayed start.</p> <p>Delay the start by 1-24 hours by pressing the -/+ buttons.</p> <p>Finish by pressing the Start/Stop button. The machine counts down 1 hour at a time and starts after the selected delay.</p>
1 Only machines with panel type I		

Service menu TD60.3

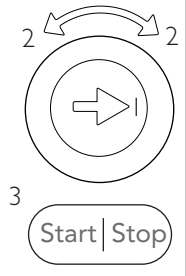

This is how to enter the service menu	
	<p>If the machine is on: First turn off the power at the main power switch. Press and hold the Program Selector while turning on the main power switch.</p>
	<p>Press the program selector button 3 times within 5 seconds. You are now in the service menu. See instructions below for navigating the service menu.</p>

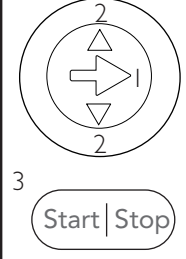
Program selector	
	<ol style="list-style-type: none"> 1. Press the program selector button to scroll between the various service menus. 2. Turn the program selector button to make a selection between the menus. Confirm the selection and go to the next menu by pressing the program selector button (I). 3. Press the Start/Stop button to confirm the settings and exit the service menu.





Program selector (integrated machines)	
	<ol style="list-style-type: none"> 1. Press the program selector button to scroll between the various options. 2. Press the small arrows to make a selection between the options. Confirm the selection and go to the next option by pressing the program selector button (I). 3. Press the Start/Stop button to confirm the settings and exit the service menu.

Service menu TD60.3

The options below are displayed in the order they occur in LCD 2. All display text language versions are displayed.

Press/turn	LCD 2	Comments/instructions
 	DataSerialNo, Data Ser Num, Data-SerialNo, DataSerialNo, Seriennummer, Seriennummer, Dataversio Nro, N° de série, Seriennummer; Num. di serie, N° de serie, Серийный номер, Seriennummer	Date for programming the software (Year_Week)
	CU date code, CU Date Code, CU date code, CU datum kod, CU dato kode, Styrekort prod dato, CU pvm koodi, Code date CU, CU Datumscode, Codice data CU, Código fecha CU, КОД ДАТЫ БУ, CU datacode	Control unit's date of manufacture (Year_Week)
	Software, Software, Software, Mjukvara, Software, Software ver., Ohjelmisto, Logiciel, Software, Software, Software, Версия прог., Software	Software version number.
	No. of cycles, Number of Cycles, No. of cycles, Antal cykler, Antal cyklusser, Antall bruk, Syklien lkm, Nb. de cycles, Anzahl der Zyklen, Numero cicli, N° de ciclos, Кол-во циклов, Aantal cycli	Number of cycles/programs run
	Press (Start Stop) to exit the service menu.	
	"Error_Number of cycles"	Last three errors and number of cycles (when the error occurred) shown. Total reset deletes the error indications from the system. If the same error recurs at different times, this is shown, but only once in the list.
	"Error_Number of cycles"	
	"Error_Number of cycles"	
	Press (Start Stop) to exit the service menu.	
	Testing, Test, Test, Tester, Test, Testaus, Essai, Test, Test, Test, Тестирование, Testen	
Testing Motor, Test motor, Motortest, Tester motor, Test av motor, Mootoritest, Essai moteur, Test motor, Test motore, Test motor, Тест мотора, Motor testen	Normal action: The motor will run continuously.	
Testing Heater I, Test heater I, Elementtest I, Tester varmelegeme I, Test av element I, Vastustesti I, Essai él. chauff I, Test verw. element I, Test el. risc. I, Test elem calef I, Тест ТЭНа I, Heizungstest I	<p>Motor runs continuously. Heater I runs regulated on and off by CU regarding to measured thermistor values. Total consumption is app. 9A in this mode. If value differs, do the following:</p> <ol style="list-style-type: none"> 1. Detach the panel 2. Disconnect electrical connections at the CU. 3. Measure DC Ω for heaters and related wires. For values and measure points, see chapter "Components and measurement values" and "Wiring diagram". <p>IF THE VALUES ARE INCORRECT: Check the electrical function for connections and heater. Change parts if needed.</p> <p>IF THE VALUES ARE CORRECT:</p> <ol style="list-style-type: none"> a) Start the component test ("Test heater I") b) Measure AC voltage directly on the CU (see wiring diagram for measuring points). Voltage should be the same as power supply net. c) If values are out of range: Replace the CU. <p>LCD shows " _ _ _ _ _ : XX°C YY°C ZZ °C". XX = temperature values for thermistor 1 YY = temperature values for thermistor 2 ZZ = temperature values for thermistor 3</p> <p>>100°C (XX) = short-circuit in thermistor 1 (heating element does not start) 10°C (XX) = thermistor 1 faulty (heating element heats but is only regulated by the overheating protection). >100°C (YY) = short-circuit in thermistor 2 (heating element does not start) 10°C? \pm 2°C (YY) = thermistor 2 faulty (functions as vented dryer). 150°C (ZZ) = thermistor 3 short-circuited 25°C (ZZ) = thermistor 3 faulty</p>	

CONTINUE ON NEXT PAGE

		<p>To verify indication on faulty thermistor, do the following:</p> <ol style="list-style-type: none"> 1. Detach the panel 2. Disconnect electrical connections at the CU. 3. Measure DC Ω for thermistor and related wires. For values and measure points, see chapter "Components and measurement values" and "Wiring diagram". <p>IF THE VALUES ARE INCORRECT: Check the electrical function for connections and thermistor. Change parts if needed.</p> <p>IF THE VALUES ARE CORRECT:</p> <ol style="list-style-type: none"> a) Start the component test ("Test heater X") b) Measure AC voltage directly on the CU (see wiring diagram for measuring points). Voltage should be 5Vdc. c) If values are out of range: Replace the CU. <p>Thermistor 2 has no affect in the component test.</p>
	<p>Testing Heater 2, Test heater 2, Elementtest 2, Tester varmelegeme 2, Test av element 2, Vastustesti 2, Essai él. chauf 2, Test verw. element 2, Test el. risc. 2, Test elem calef 2, Тест ТЭНа 2, Heizungstest 2</p>	<p>Motor runs continuously. Heater 2 runs regulated on and off by CU regarding to measured thermistor values. Total consumption is app. 2A in this mode. If value differs, follow the instructions for "Testing heater 1"</p>
	<p>Testing Drain, Test drain, Tömningstest, Tester udpumpning, Test av tømning, Tyhjennystesti, Essai essorage, Test afvoerpomp, Test scarico, Test drenaje, Тест слива, Abflusstest</p>	<p>Drain pump runs. If no action:</p> <ol style="list-style-type: none"> 1. Detach the panel 2. Disconnect electrical connections at the CU. 3. Measure DC Ω for drain pump and related wires. For values and measure points, see chapter "Components and measurement values" and "Wiring diagram". <p>IF THE VALUES ARE INCORRECT: Check the electrical function for connections and drain pump. Change parts if needed.</p> <p>IF THE VALUES ARE CORRECT:</p> <ol style="list-style-type: none"> a) Start the component test ("Testing drain") b) Measure AC voltage directly on the CU (see wiring diagram for measuring points). Voltage should be the same as power supply net. c) If values are out of range: Replace the CU. d) If the values are correct: Check drain pump for mechanical disturbance. Change pump if necessary.
 	<p>Testing Buzzer, Test buzzer, Signaltest, Tester lydsignal, Test av lydsignal, Äänimerkkitesti, Test signal sonore, Test eindsignaal, Test allarme, Test timbre, Тест звук.сигнала, Summertest</p>	<p>Buzzer is on continuously.</p>
	<p>Press  to exit the service menu.</p>	
	<p>0</p> <p>+3</p> <p>+2</p> <p>+1</p> <p>-1</p> <p>-2</p> <p>-3</p>	<p>Adjust LCD contrast (0 = default)</p>
	<p>Press  to exit the service menu.</p>	
	<p>0</p> <p>+5</p> <p>+10</p> <p>+15</p> <p>+20</p>	<p>Adjustment of drying time</p> <p>Dry level: 0 (no extension, default level), +5 (5 minutes extension), +10 (10 minutes extension), +15 (15 minutes extension), +20 (20 minutes extension).</p>
	<p>Press  to exit the service menu.</p>	
	<p>Reset</p>	

Service menu TD60.2

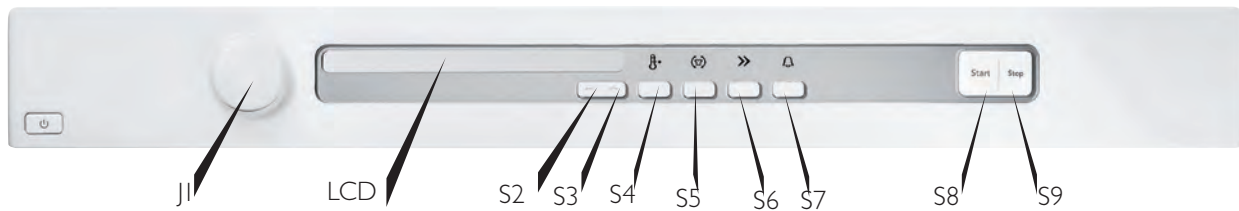

ⓘ	Switch off, and then on main power.
S3	<ul style="list-style-type: none"> Pressing S3 when power on followed by 3 pushes on S6 within 5 sec enters the service menu.
NOTE!	Make all selections. Pressing S8 stores all selections made in service menu and leaves Service mode.
Turn J1	<p>Tracking data read out</p> <p>SP: (Software programming date: year week)</p> <p>CM: (Control unit manufacturing date: year week)</p> <p>SV: (Software version)</p> <p>NC: Number of cycles</p> <p>Press S9 next step is accessed.</p>
	<p>Failure read out</p> <p>LCD will display last fault and cycle no: ex "Max time, 451". Rotating J1 will display 2nd and 3rd last deviating fault, Failure record is cleared by total reset</p> <p>Press S9 next step is accessed.</p>
	<p>Diagnostics</p> <p>Separate test of auxiliary components.</p> <p>Rotating J1 each component will be turned on (with a 1 sec delay) and inputs detected in sequence:</p> <p>"Testing" (no component),</p> <p>"Testing motor" (motor on),</p> <p>"Testing heater 1" (motor and heater 1 on max 70°),</p> <p>"Testing heater 2" (motor and heater 2 on max 70°),</p> <p>"Testing drain" (drain pump on - condense only),</p> <p>"Testing buzzer" (buzzer on),</p> <p>Press S9 next step is accessed.</p>
	<p>Dryness adjustment</p> <p>Turn J1</p> <p>Dry level: 0 (default, no extension)</p> <p>Dry level: 5 (5 minutes extension)</p> <p>Dry level: 10 (10 minutes extension)</p> <p>Dry level: 15 (15 minutes extension)</p> <p>Dry level: 20 (20 minutes extension)</p> <p>Pressing S9 the first step is accessed or S8 to store and leave Service mode</p>

Service menu TD60.1

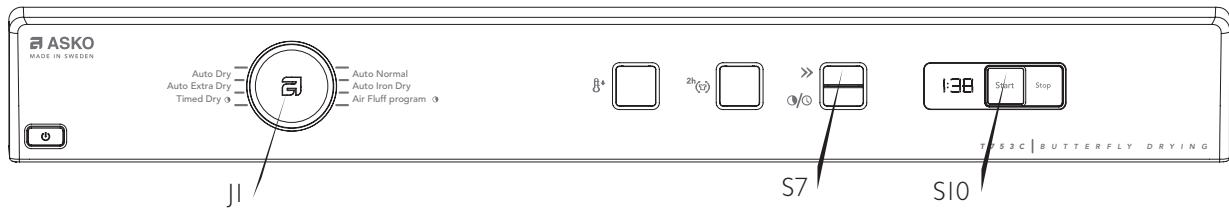

Start + 	Press and hold Start (S10) and switch on the machine.
Start × 5	Press Start (S10) 5 times within 5 seconds to enter the service menu.
	<p>Diagnostics</p> <p>Separate component tests</p> <p>Turn the programme selector (J1), each component is turned on with a 1-second delay:</p> <p>"Testing": no component being tested</p> <p>"Testing motor": motor on</p> <p>"Testing element 1": motor and heating element 1 on max 70°</p> <p>"Testing element 2": motor and heating element 2 on max 70°</p> <p>"Testing pump": drainage pump on - only condenser</p>
	Press Time saver (S7) to stop the test and continue.
	<p>Extended drying time</p> <p>Turn the programme selector (J1)</p> <p>Drying level L0: (default, no extension)</p> <p>Drying level L5: (5-minute extension)</p> <p>Drying level L10: (10-minute extension)</p> <p>Drying level L15: (15-minute extension)</p> <p>Drying level L20: (20-minute extension)</p>
	<p>Press Time saver (S7) to save and return to the first step (diagnostics)</p> <p>or</p> <p>Press Start (S10) to save and exit the service menu.</p>

Fault indications TD60.3

The below faults are indicated in plaintext in LCD 2. The table shows the indication in all languages and language variations.

LCD 2	Cause	Action
Overflow, Over Flow, Överflyllnad, Overfyldning, Overfylling, Ylitulviminen, Trop-plein, Reservoir legen, Trabocamento, Desbordamiento, Перелив воды, Überfüllt	A micro switch, opening, for detection of full, condensing water container: Detection shall start 30 sec after a program is started. If the micro switch is opened > 30 sec the program cycle should be stopped and cleared.	Check if the customer has: <ul style="list-style-type: none"> • Emptied the tank and restarted the machine Service action: <ul style="list-style-type: none"> • Clean hoses and check voltage and resistance in the drain pump. • Check that the float has not got "stuck" and check the function of the micro-switch.
Max Program Time, Max program time , Maximal programtid, Maksimal programtid, Maks programtid, Max ohjelma-aika, Durée maxi prog., Tijd overschreden, Tempo max. progr., Duración máx prog, Превышение времени,, Max. Programmzeit	The cycle time exceeds 200 minutes. The cycle interrupts and the program is cleared. High ambient temperature combined with low element output and low drying temperature leads to condensation formation. Poor condensation due to blocked external air	Check if the customer has: <ul style="list-style-type: none"> • Tried spinning at a higher speed • Has the machine switched off for 30 minutes before restarting • Good ventilation in the room Service action: <ul style="list-style-type: none"> • Ensure that the external air has free passage.
Thermistor fault, Thermistor Fault, Thermistor fault, Termistorfel, Termostat fejl, Termistor, Termistorivika, Défaut , Termistorfehler, Termistore , Fallo , Термистор, Temp. sensor fout	1) The circuit for the thermistor is open. 2) The thermistor is faulty	Service action: Check the thermistors function. If needed, replace it.
Clean condenser, Rengör kondensator, Rens kon.sator; Rens kon.sator; Puhdista lauhdutin, Nettoyage condenseur, Reinigen kondensator, Pulizia condensatore, Limpiar condensador, Очистить конденсатор, Kondenser reinigen	1) Indicated for each 100 cycle. 2) Indicated if the machine has indicated "Clean lint filter" 2 times.	Check if the customer has: <ul style="list-style-type: none"> • Cleaned the condenser and filter • Cleaned other air ducts
Clean Lint Filter; Clean Lint Filter; Rengör filtret, Rengør frugfilter; Rens filter; Puhdista sihti, Nettoyage filtre, Reing filter, Pulizia filtro, Limpie el filtro, Очистить фильтр, Sieb reinigen	Indicated when air circulation and temperature are incorrect	Check if the customer has: <ul style="list-style-type: none"> • Cleaned the filter

After carrying out corrective actions as above, reset the fault indications by switching off the machine using the main power switch.

Fault indications TD60.2

Error messages		
	Cause	Action
Over flow	<ul style="list-style-type: none"> • A micro switch, opening, for detection of full, condensing water container. Detection shall start 30 sec after a program is started. If the micro switch is opened > 30 sec the program cycle should be stopped and cleared. 	<ul style="list-style-type: none"> • Check if the customer has Emptied the tank and restarted the machine • Clean hoses and check voltage and resistance in the drain pump. • Check that the float has not got "stuck" and check the function of the micro-switch.
Max program time	<ul style="list-style-type: none"> • The cycle time exceeds 200 minutes. The cycle interrupts and the program is cleared. • High ambient temperature combined with low element output and low drying temperature leads to condensation formation. • Poor condensation due to blocked external air 	<p>Check if the customer has:</p> <ul style="list-style-type: none"> • Tried spinning at a higher speed. • Has the machine switched off for 30 minutes before restarting • Good ventilation in the room • Ensure that the external air has free passage.
Clean lint filter	<ul style="list-style-type: none"> • Indicated when air circulation and temperature are incorrect. 	
Clean condensor	<ul style="list-style-type: none"> • Indicated for each 100 cycle • Indicated if the machine has indicated "Clean lint filter" 2 times. 	<ul style="list-style-type: none"> • Clean the condensor and filter • Clean other air ducts
Thermistor fault	<ul style="list-style-type: none"> • The circuit for the thermistor is open. • The thermistor is faulty 	<ul style="list-style-type: none"> • Check the thermistors function. If needed, replace it.
Press stop button to exit fault indications		

Fault indications TD60.1

Error messages panel type 1		
Indication	Cause	Action
F1 flashes on the display	<ul style="list-style-type: none"> The condensation water tank is full. 	Empty the container and restart the machine.
F2 flashes on the display	<ul style="list-style-type: none"> Maximum permitted programme time reached. 	Empty the condensed water container and check that neither the fluff filter nor the condenser are clogged. Overly long drying times may also be due to the tumble dryer being located in a confined area or room that is too small, causing the air to become too hot. Make sure that the tumble dryer has access to more cold air, e.g. by opening doors and/or windows.

Error messages panel type 2		
Indication	Cause	Action
The light to the left of the start button flashes	<ul style="list-style-type: none"> The condensation water tank is full. 	Empty the container and restart the machine.
The light above the start button flashes	<ul style="list-style-type: none"> Maximum permitted programme time reached. 	Empty the condensed water container and check that neither the fluff filter nor the condenser are clogged. Overly long drying times may also be due to the tumble dryer being located in a confined area or room that is too small, causing the air to become too hot. Make sure that the tumble dryer has access to more cold air, e.g. by opening doors and/or windows.

Other faults TD60

Fault symptom	Cause	Action
The machine will not start	The outer door is not properly closed.	<ul style="list-style-type: none"> • Check that the door pin is activating the door switch.
	The machine is not supplied with power.	<ul style="list-style-type: none"> • Check the fuses and connections.
The machine stops	The automatic overheating protection has tripped.	<p>Check if the customer has:</p> <ul style="list-style-type: none"> • Opened the door and cleaned the filter and condenser unit • Left the door open long enough for the overheating protection to be reset and the display and LEDs to light up • Attempted to restart the program <p>Service action:</p> <ul style="list-style-type: none"> • Clean internal fan wheel, condenser, air ducts and element. • Check the seals.
	The overheat protection in the motor has been tripped.	<ul style="list-style-type: none"> • Clean and check the motor. • If necessary, replace the motor.
	Defective control unit	<ul style="list-style-type: none"> • Replace control unit.
The washing does not get dry	Air leakage at the door seals is affecting the drying results.	<ul style="list-style-type: none"> • Check the sealing strips.
	Air leakage around the motor shaft affects the drying result.	<ul style="list-style-type: none"> • Check the seal around the motor shaft.
	Defective rear thermistor	<ul style="list-style-type: none"> • Replace the thermistor.
	Defective control unit	<ul style="list-style-type: none"> • Replace control unit.
The washing does not get dry.	Mixing of various types of items can lead to uneven drying results.	<p>Customer information:</p> <ul style="list-style-type: none"> • Check that different types of items are not mixed in the same machine. Remove the dry items.
	How full the machine is affects the drying results.	<p>Customer information:</p> <ul style="list-style-type: none"> • Check that the machine is not overfilled. Remove some of the washing if necessary.
Tumble-drying takes too long.	The lint filter is blocked.	<p>Customer information:</p> <ul style="list-style-type: none"> • Cleaning the lint filter.
	The condenser unit is blocked.	<p>Customer information:</p> <ul style="list-style-type: none"> • Clean the condenser.
	The washing machine's spinning affects drying.	<p>Customer information:</p> <ul style="list-style-type: none"> • Spin at a minimum of 800 rpm.
	The machine is in a room with poor ventilation.	<p>Customer information:</p> <ul style="list-style-type: none"> • Open doors to adjacent rooms.
	The evacuation hose is too long, blocked or bent.	<p>Customer information:</p> <ul style="list-style-type: none"> • Try to make the hose length as short as possible with as gentle bends as possible.

Total reset TD60.3

By pressing STOP (S3) + MAIN POWER SWITCH when power on the machine shall total reset. All settings is returned to default values).

Heater 2 activation TD60.3

Heater 2 can be programd active or inactive.

Do the following:

1. Press STOP (S3) + MAIN POWER SWITCH
 2. Press STOP (S3) five times (within 10 sec.)
 3. Turn the Program selector (J1), choose "Heater 2 On" or "Heater 2 Off".
- Press the Program selector (SI) to store the settings.

Total reset TD60.2

By pressing STOP (S9) + MAIN POWER SWITCH when power on the machine shall total reset. All settings is returned to default values)

Heater 2 activation TD60.2

Heating element 2 can be activated/deactivated by programming the machine.

- Turn off the machine using the main power switch.
- Press and hold -/+ button and the button for temperature and turn on the main power switch
- Turn the Program selector, choose "Heater 2 On" or "Heater 2 Off"
- Press the start button to store the settings

Total reset TD60.1





A total reset is achieved by pressing the stop button when the machine is on. All settings are restored to their default values.







Activating heating element 2 TD60.1

Heating element 2 can be activated/deactivated by programming the machine.

- Turn off the machine using the main power switch.
- Press and hold the Anti-crease button and turn on the main power switch. This opens the menu for activating/deactivating heating element 2.
- Press the Time save button to activate/deactivate the heating element. When the heating element is deactivated, the lights for Normal dry and Iron dry flash in sync. When the heating element is activated, the lights for Normal dry, Iron dry and temperature flash in sync.
- Press the Stop button to save and exit the menu for activating/deactivating heating element 2.

Shop programme TD60.3

1. Activating the Shop programme (for machines manufactured up to week 736)	
 + 	<p>If the machine is on: First turn off the power at the main power switch. Then press and hold the Start button while turning on the main power switch. At this point no settings can be made. The centre display will activate after 3 minutes. Settings can now be made, but the machine cannot be started.</p>
2. Stopping the Shop programme (for machines manufactured up to week 736)	
 + 	<p>First turn off the power at the main power switch. Then press and hold the Start button while turning on the main power switch. The Shop program is now stopped.</p>

1. Activating the Shop programme (for machines manufactured from week 737 on)	
 +   x5	<p>If the machine is on: First turn off the power at the main power switch. Then press and hold the Start button while turning on the main power switch. Press the program selector 5 times At this point no settings can be made. The centre display will activate after 3 minutes. Settings can now be made, but the machine cannot be started.</p>
2. Stopping the Shop programme (for machines manufactured from week 737 on)	
 +   x5	<p>First turn off the power at the main power switch. Then press and hold the Start button while turning on the main power switch. Press the program selector 5 times. The Shop program is now stopped.</p>

Store programme TD60.2 and TD60.1

There are no store programmes on the TD60.2 and TD60.1.

Components and measurement values TD60

Item number	Component	Measurement value	Comments
80 618 24	Motor 50 Hz, 220/240 V	Main winding: 23.8 Ω Auxiliary winding: 28.1 Ω Current: 1.1 A; 270 W; 2850 rpm	
80 618 95	Motor 60 Hz, 220/240 V	Winding resistance: cable colour grey-blue 25.5 Ω cable colour grey-red 16.0 Ω Current: 0.9 A; 200 W; 3300 rpm	The motor is a 2-pin motor and is directly connected to the fan for internal air and gearing for driving the cylinder. The fan for external air is also driven on condenser dryers.
73 829 92	Capacitor 6 μ F		The capacitor is mounted on the motor.
80 546 40	Capacitor 4 μ F		
88 011 94	Condensing waterpump 25W	111 Ω	
80 762 02	EMC filter with inductor		The filter eliminates interference to and from the machine.
80 762 24	Thermistor	4 – 6 k Ω (at room temperature 20 – 30°C)	The thermistor controls temperature regulation. If the thermistor is short-circuited or detaches from the control unit, the program is cancelled.
80 792 91	Thermistor	8 - 12 k Ω (at room temperature 20 – 30°C)	
80 773 85	Thermostat/Overheating protection (150°C automatic)		The thermostat /overheating protection interrupts the program at too high temperatures.
80 792 00	Thermostat/Overheating protection (135°C automatic)		
80 761 04	Door switch		The front door affects a door switch, which interrupts the program when the door is opened. If the door has been opened and closed during the program the machine must be restarted using the start/stop button.
80 761 03	Microswitch float		If both containers are overfilled the program is interrupted by a float switch located on the lower holder. Overfilling is indicated in the display.
	Electrical connection		The machine is delivered as single phase and can be switched between 1950 W, 10 A and 2500 W, 16 A. Adjustment between 1950 W / 10 A and 2500 W / 16 A is carried out using software via buttons.
88 013 27	Control Unit compl. TD60.3		The control unit contains microprocessors for controlling programs, motor, element etc.
8080604	Control Unit		
8079287	Heating Element 2500W	Heater 1: 1950W, 24,5 Ω Heater 2: 550W, 91,4 Ω	
8079288	Heating element 3000W	Heater 1: 1950W, 24,5 Ω Heater 2: 1050W, 45,3 Ω	

Technical data TD60

Height:	850 mm
Width:	595 mm
Depth:	585 mm
Weight:	39kg (vented) 47 kg (condenser)
Cylinder volume:	111 l
Max. loading capacity:	Eu 7.0 kg, US, AU 6.0 kg
RPM:	52 rpm
Rated power:	1950 W = 10 A 2500 W = 16 A Adjustment between 10 and 16 A is carried out using software via buttons.
Drying drum material:	Stainless steel
Outer casing material:	Powder-coated and hot-galvanized sheet steel or stainless steel
Set-up:	Stacking or freestanding
Protection class:	IP X4

Wiring diagram TD60.3

RESISTANCES AT ROOM TEMPERATURE (CA. 20°C/68°F)
VALUES WITH +/-10% ARE REGARDED AS NORMAL
COMPONENT

- F: RADIO INTERFERENCE SUPPRESSION FILTER 680K Ohm
- NTC 1: THERMISTOR 1 4- 6 K Ohm
- NTC 2: THERMISTOR 2: 4- 6 K Ohm
- NTC 3: THERMISTOR 3: 12- 8 K Ohm
- AP: DRAIN PUMP: 111 Ohm
- EL: HEATING ELEMENT 550W 91.4 Ohm
- EL: HEATING ELEMENT 1050W 45.3 Ohm
- EL: HEATING ELEMENT 1950W 20.5 Ohm
- T1: THERMOSTAT, OVERHEATING (HEATER)
- T2: THERMOSTAT, FAN HOUSING
- T3: THERMOSTAT, OVERHEATING (HEATER)
- FB: FLOAT SWITCH
- DB: DOOR SWITCH
- MO: MOTOR PUMP
- TB: MAIN SWITCH
- *A CONDENSE DRYER
- *B IN SOME MACHINES

— WIRES IN ALL MACHINES
- - - WIRES IN SOME MACHINES

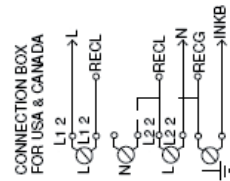
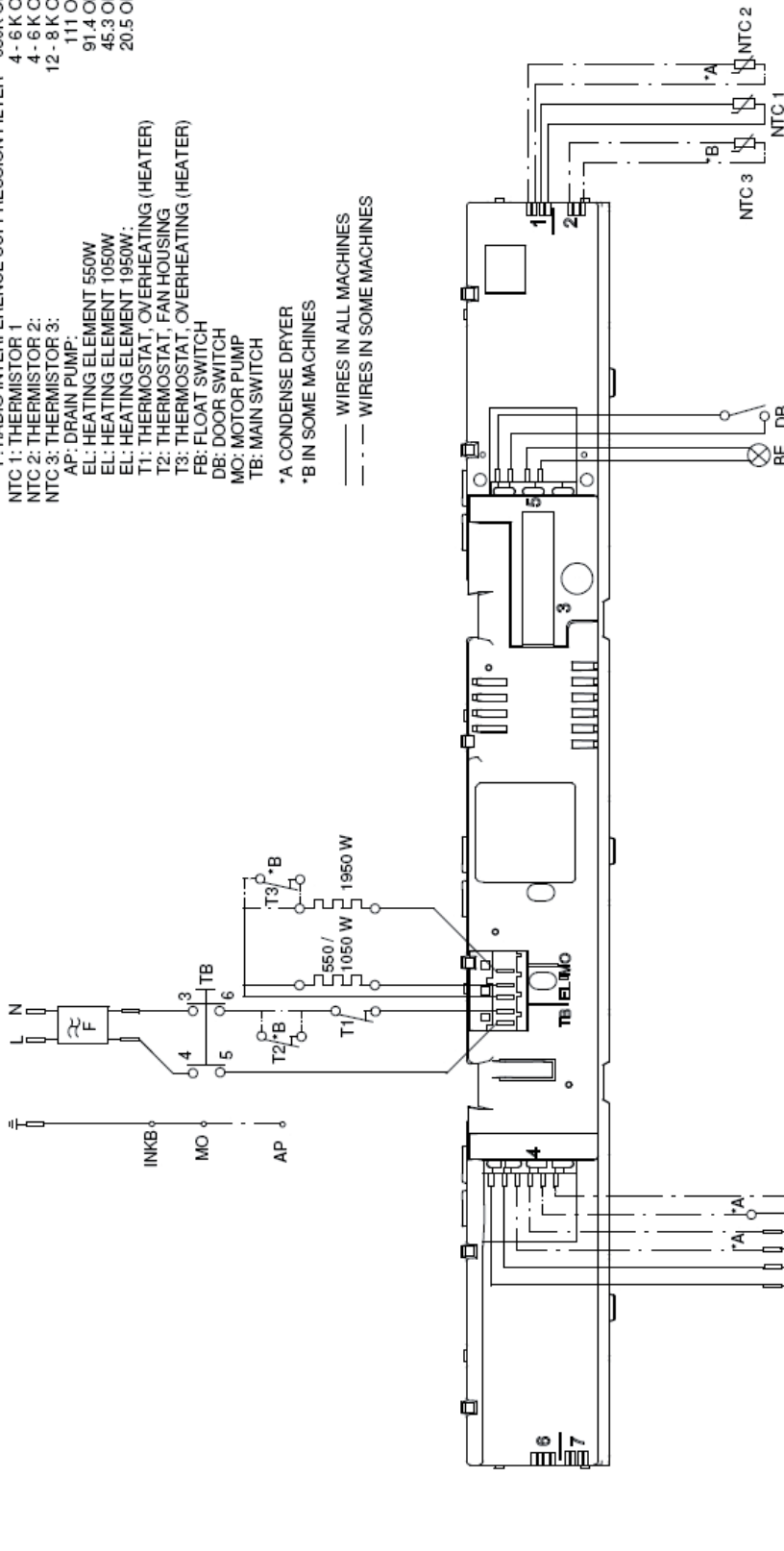

CIRCUIT DIAGRAM TD60.3

80 788 72 - 01

This document must not be copied without
our written permission, and the contents
thereof must not be disseminated to third party
without our written permission. In the
Czech Republic, any unauthorized copying,
distribution or use will be prosecuted.
Astro Cylinda AB

FORMAT A3

Wiring diagram TD60.2

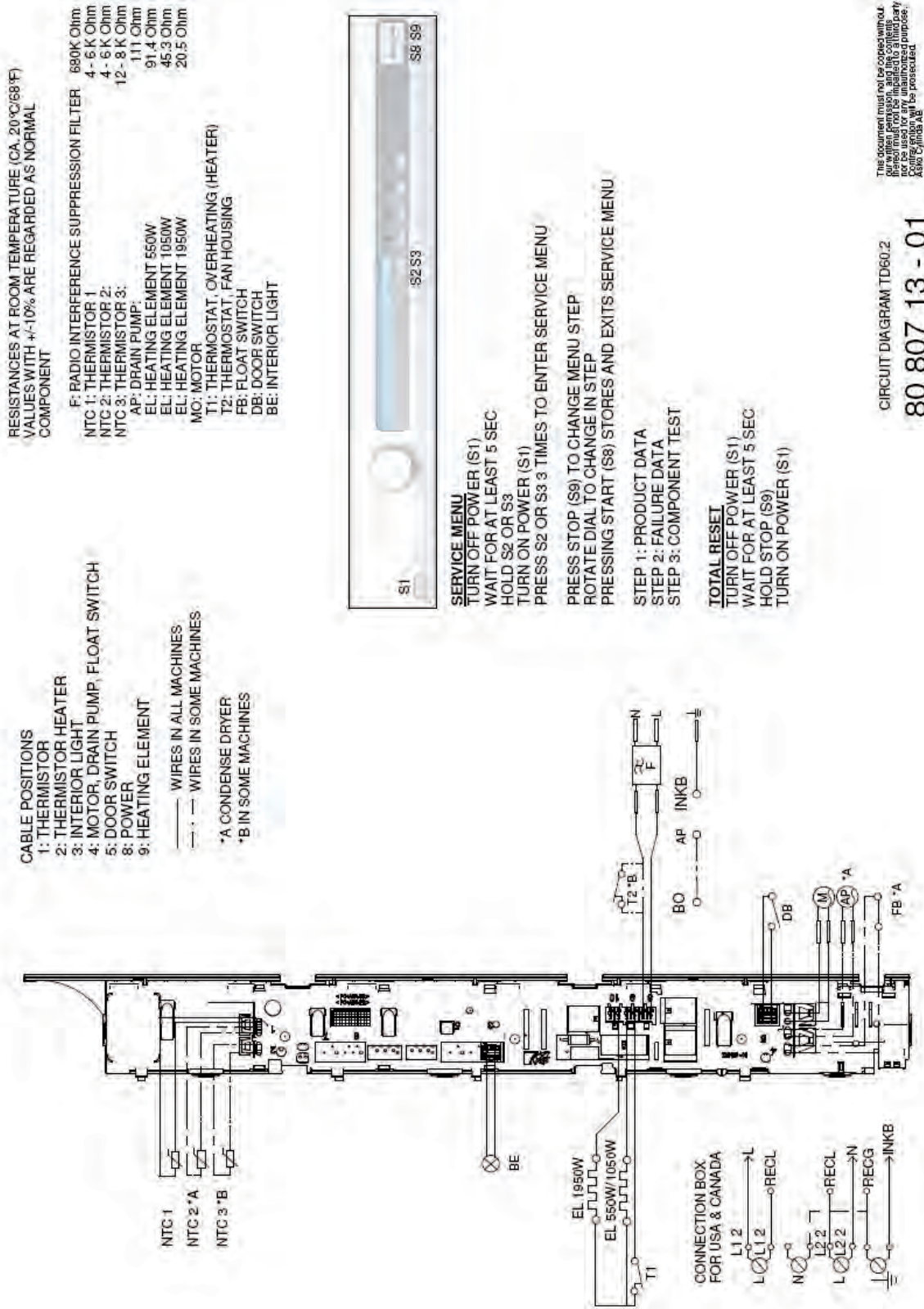

Wiring diagram TD60.1

RESISTANCES AT ROOM TEMPERATURE (CA. 20°C/68°F)
VALUES WITH +/-10% ARE REGARDED AS NORMAL COMPONENT

- F: RADIO INTERFERENCE SUPPRESSION FILTER 680K Ohm
- NTC 1: THERMISTOR 1 4 - 6 K Ohm
- NTC 2: THERMISTOR 2: 4 - 6 K Ohm
- AP: DRAIN PUMP: 111 Ohm
- EL: HEATING ELEMENT 550W 91.4 Ohm
- EL: HEATING ELEMENT 1050W 45.3 Ohm
- EL: HEATING ELEMENT 1950W 20.5 Ohm
- MO: MOTOR
- T1: THERMOSTAT, OVERHEATING (HEATER)
- T2: THERMOSTAT, FAN HOUSING
- FB: FLOAT SWITCH
- DB: DOOR SWITCH



TOTAL RESET

- TURN OFF POWER (S1)
- WAIT FOR AT LEAST 5 SEC
- HOLD STOP (S11)
- TURN ON POWER (S1)

SERVICE MENU

- TURN OFF POWER (S1)
- WAIT FOR AT LEAST 5 SEC
- HOLD S10
- TURN ON POWER (S1)
- PRESS S10 5 TIMES TO ENTER SERVICE MENU
- PRESS STOP (S11) TO CHANGE MENU STEP
- ROTATE DIAL TO CHANGE IN STEP
- PRESSING START (S10) STORES AND EXITS SERVICE MENU

- CABLE POSITIONS
- 1: THERMISTOR
 - 4: MOTOR, DRAIN PUMP, FLOAT SWITCH
 - 5: DOOR SWITCH
 - 8: POWER
 - 9: HEATING ELEMENT

— WIRES IN ALL MACHINES
- - - WIRES IN SOME MACHINES
*A CONDENSE DRYER

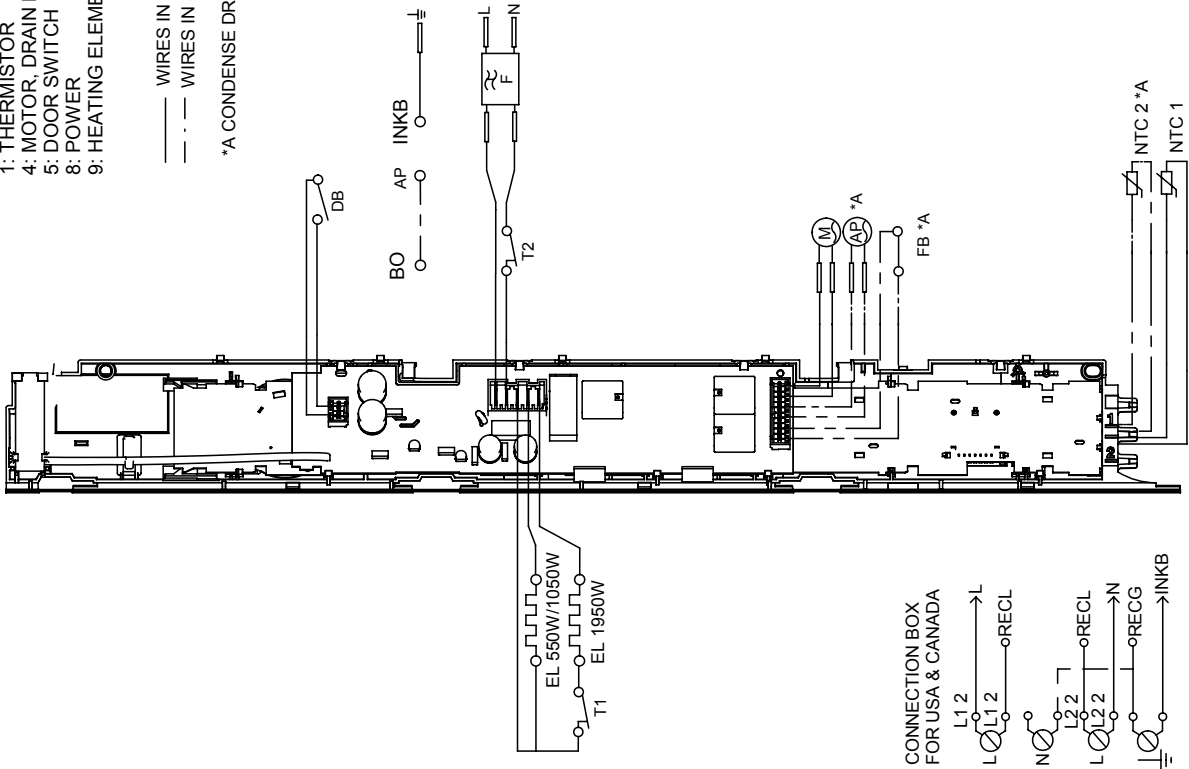

CONNECTION BOX
FOR USA & CANADA

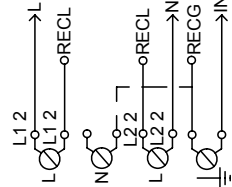

2009-09-03



CIRCUIT DIAGRAM TD60.1

80 820 34 - 01

This document must not be copied without our written permission, and the contents thereof must not be imparted to a third party without our written permission. Infringement or unauthorized reproduction will be prosecuted. Asko Appliances AB







Rehanging the door

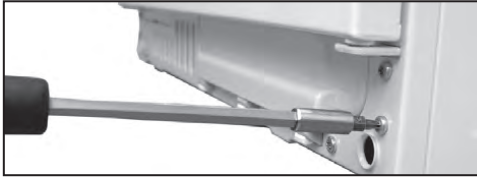
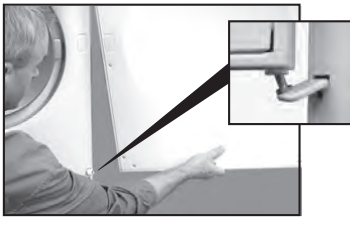
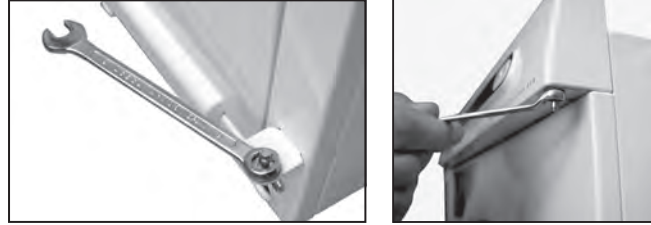
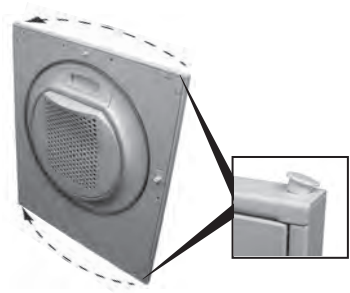

The tumble dryer (only certain models) is supplied with the door hung on the right-hand side. It is, however, possible to re-hang it according to the instructions below. Take care not to damage the paint when carrying out work with tools.

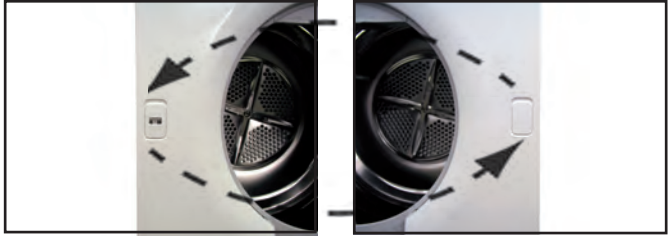
Required tools	
Flathead screwdriver	
Torx size 20	
Fixed spanner size 8	

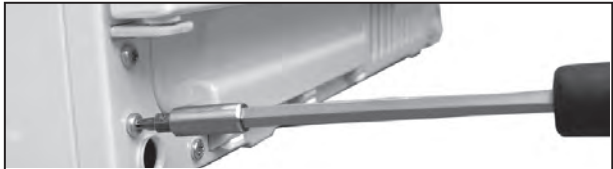

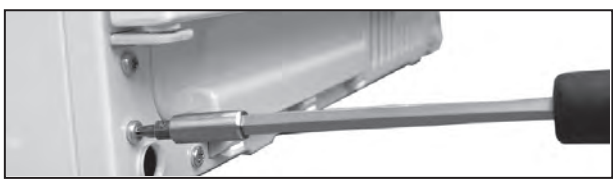
Instructions	Image
1. Remove the plinth by carefully pulling it out.	
2. Remove both screws for the lower hinge. Use Torx.	
3. Push the door upwards with care and angle outwards. If necessary, carefully press the lower hinge to detach the door.	
4. Slacken off the lower and upper hinge pins using a fixed spanner.	
5. Remove the plastic plugs covering the holes for the hinge pins and switch location	

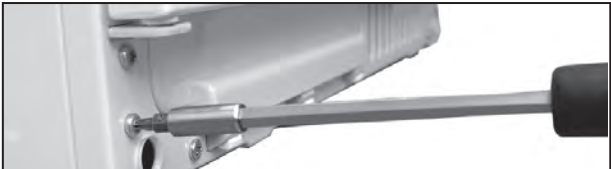
<p>Method for removing plastic plugs, lock and catch located on the machine and the door:</p> <p>Carefully push the plug, catch or lock upwards with a flat screwdriver. as the picture shows.</p>	
<p>6. Carefully remove the catch and plastic plug on the door and switch location.</p>	
<p>7. Carefully remove the lock and plastic plug on the machine and switch location.</p>	
<p>8. Screw the hinge pins securely into place on the corresponding side of the machine.</p>	
<p>9. Slacken off the screws for the lower hinge on the corresponding side of the machine. This must be done to hang the door.</p>	
<p>10. Align the door in the upper hinge. Carefully push the lower hinge down if necessary and align the door.</p>	
<p>11. Screw the lower hinge into place securely. Use Torx.</p>	

<p>11. Screw the lower hinge. Use Torx.</p>	
<p>12 Press the plinth into place. The door has now been re-hung.</p>	

Replacing panel

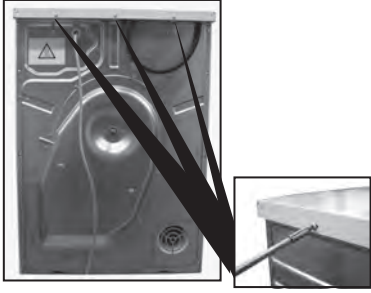
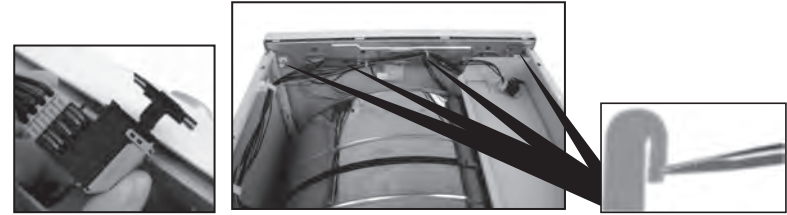
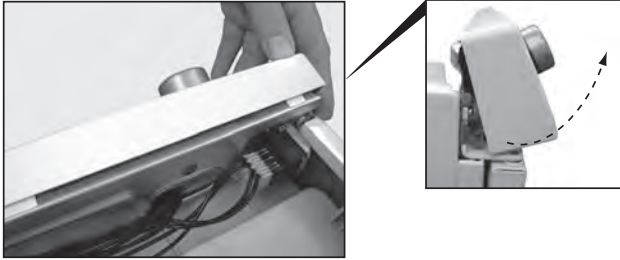
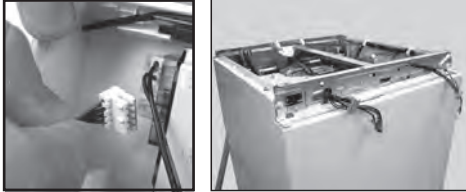
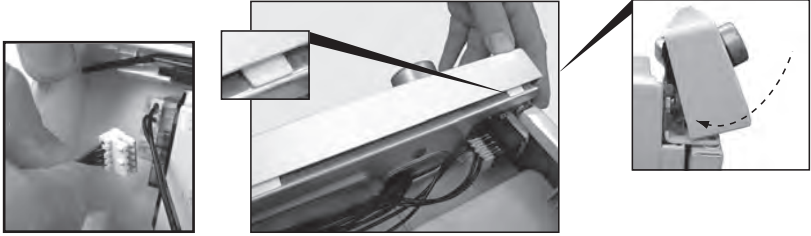
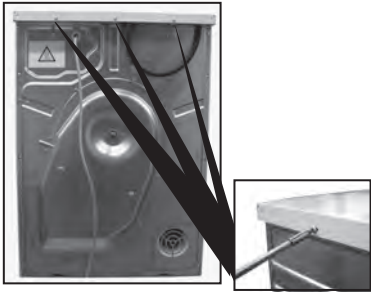
Instructions	Image
<p>1. Unscrew the top cover.</p>	
<p>2. First, remove the main push switch. Carefully press the catches that secure the panel at the front beam. Release the catches from the front member by working the panel outwards.</p>	
<p>3. Detach the panel by angling and pulling it carefully outwards at the lower edge.</p> <p>Note: Do not damage the wiring!</p>	
<p>4. Carefully disconnect the wiring from the control unit.</p>	
<p>11. When installing the panel: First install all wiring in the relevant locations on the control card.</p> <p>Then angle the panel outwards and place the mounting plates in the relevant grooves in the front frame. Angle the panel downwards and secure it with the catches</p>	
<p>12. Screw the top cover into place.</p>	

Timerdiagram

Timer diagram (description of program flow) TD60

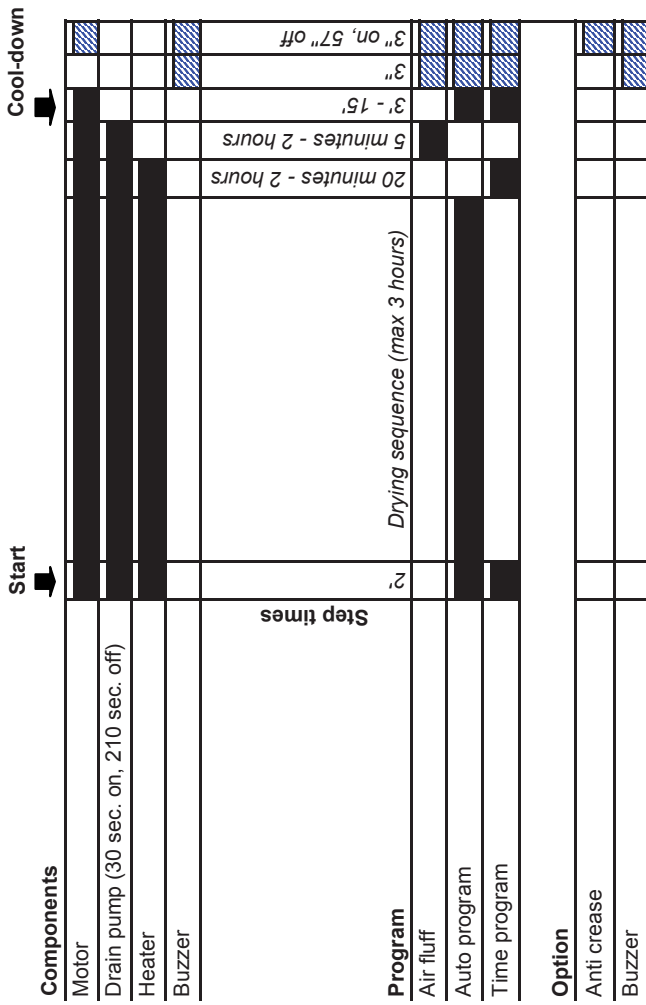

Table explanation

	Option
--	--------