



**TECHNICAL EDUCATION**  
**Whirlpool, Amana and Maytag**  
**TOP-MOUNT**  
**REFRIGERATOR/FREEZERS**



# FORWARD

This Job Aid, Top Mount Refrigerators (Part Number LIT) has been compiled to provide the recent information on design, features, operation, troubleshooting and repair procedures of 14 through 22 cu. ft. top-mount refrigerator/freezers.

This Job Aid is not intended to replace or substitute for the Service Manuals, Use and Care Guides or Tech Sheets associated with any of the models covered. Refer to the Technical Service sheet shipped with the refrigerator for detailed information for the refrigerator you are servicing.

## GOALS AND OBJECTIVES

The goal of this Job aid is to provide basic information that will enable the service technician to properly diagnose malfunctions and repair 14 through 22 cu. ft. top-mount refrigerator/freezers.

- The objectives of this Job Aid are to help the Service Technician to:
- Understand proper safety precautions.
- Successfully troubleshoot and diagnose malfunctions.
- Successfully perform necessary repairs.
- Successfully return the refrigerator to proper operational status.

Specific components covered in this Job Aid are:

- Compressor
- Defrost Heater
- Defrost Bimetal
- Overload Protector
- Condenser Fan Motors
- Defrost Timer
- Start Relay
- Start Module
- Thermostat
- ADC

At the end of certain sections of this Job Aid you will find a “Confirmation of Learning Exercise.” After completing this booklet, you will be familiar with the electrical components and systems common to refrigerators normally used in multi-unit dwellings. Keep this book for future reference.

WHIRLPOOL CORPORATION assumes no responsibility for any repairs made on our products by anyone other than Authorized Service Technicians.

Copyright © 2009, Whirlpool Corporation, Benton Harbor, MI 49022

# TABLE OF CONTENTS

	Page
<b>FORWARD</b> .....	<b>ii</b>
<b>GOALS AND OBJECTIVES</b> .....	<b>ii</b>
<b>TABLE OF CONTENTS</b> .....	<b>iii-v</b>
<b>SAFETY</b> .....	<b>vi</b>
<b>INSTALLATION</b> .....	<b>1-1</b>
Packaging Examples.....	1-2
Exterior Packaging .....	1-2
Interior Packaging .....	1-2
Installing Door Shelf Components.....	1-3
Leveling The Refrigerator.....	1-4
Door Swing.....	1-5
Door Reversal .....	1-5
Connecting the Ice Maker Water Line .....	1-7
Location.....	1-9
Add on Ice Maker Kits .....	1-10
<b>THEORY OF OPERATION</b> .....	<b>2-1</b>
Top Mount Refrigerators.....	2-1
Air Distribution.....	2-1
Storage of Fresh Foods in the Refrigerator.....	2-2
Storage of Frozen Food in the Freezer .....	2-2
Compressor.....	2-3
Evaporator.....	2-3
Condenser.....	2-3
Metering Device .....	2-4
The Refrigerant System Overview .....	2-4
Thermostat.....	2-4
Dampers.....	2-4
Defrost.....	2-5
Automatic defrost .....	2-5
Cabinet construction .....	2-5
Condensation control .....	2-6
Heat loop.....	2-6
Doors.....	2-6
Door gasket.....	2-7
Crispers and Humidity controlled drawers .....	2-7
Ice Makers.....	2-7
Component location .....	2-8
<b>CONTROL COMPONENTS REFRIGERATOR COMPARTMENT</b> .....	<b>3-1</b>
Variations Of Control Box Housings.....	3-1
Accessing Control Components.....	3-2
Operating Thermostat .....	3-8
Replacing light socket .....	3-9
Light Switches.....	3-10
Defrost Timers.....	3-11
Mechanical Defrost Timers.....	3-11

## TABLE OF CONTENTS (continued)

Checking Defrost Timer.....	3-12
Defrost Timer Wiring Configurations .....	3-14
Dwell Time.....	3-15
Adaptive Defrost Theory .....	3-15
<b>EVAPORATOR COMPONENT IDENTIFICATION, ACCESS AND TROUBLESHOOTING .....</b>	<b>4-1</b>
Removing Evaporator Cover.....	4-1
Evaporator Cover Replacing Air Tower .....	4-2
Accessing Evaporator Components 2 Piece Evaporator Cover.....	4-3
Defrost Heaters .....	4-4
Checking Defrost Heater.....	4-5
Removing the defrost Heater. ....	4-6
Defrost Bimetal.....	4-7
Checking Defrost Bimetal.....	4-8
Evaporator Fan Motors .....	4-9
Removing the Evaporator Fan Motor with Shroud.....	4-10
Open design (no shroud) .....	4-11
Checking Evaporator Shaded Pole Fan Motors.....	4-12
<b>MACHINE COMPARTMENT COMPONENT IDENTIFICATION, ACCESS AND TROUBLESHOOTING .....</b>	<b>5-1</b>
Static Condenser.....	5-1
Forced Air Condenser .....	5-1
Heat loop Routing (Example).....	5-2
Accessing refrigerator compartment component .....	5-3
Compressors.....	5-4
Types Of Compressor Motors .....	5-5
Split Phase Compressor Motors .....	5-5
Permanent Split Phase Compressor Motors.....	5-5
Split Phase Motors.....	5-6
Inverter Control .....	5-7
Used With 3 Phase Compressor Motor.....	5-7
Bimetal Overloads.....	5-8
Start Module.....	5-10
Removing Start Module.....	5-10
Starting Relays.....	5-11
Removing the Condenser Fan .....	5-12
Stepper Fan Motor .....	5-12
Evaporation Pans.....	5-15
Accessing and removing rollers .....	5-16
Front Roller with Leveling Legs.....	5-16
Fixed Rear Rollers .....	5-16
<b>ICE MAKER COMPONENTS ACCESS AND TROUBLESHOOTING .....</b>	<b>6-1</b>
Removing the Ice Maker .....	6-1
Ice Maker Thermal Fuse .....	6-2

## TABLE OF CONTENTS (continued)

Water Inlet Valve .....	6-3
Checking Water Valve .....	6-3
<b>WIRING DIAGRAMS.....</b>	<b>7-1</b>
Example: Model W8TXNWMWQ Schematic .....	7-1
Example: Model W4TXNFWQ Schematic .....	7-2
<b>TROUBLESHOOTING AND DIAGNOSIS .....</b>	<b>8-1</b>
General .....	8-1
Real vs. Perceived problems .....	8-4
Basic Steps to Using Diagrams in Troubleshooting .....	8-5
Mechanical Failure Analysis.....	8-7
Analyzing Compressor Failures .....	8-9

# INSTALLATION

## Your safety and the safety of others is very important.

We have provided many important safety messages in this Job Aid and on the appliance. Always read and obey all safety messages.



This is the safety alert symbol.

This symbol alerts you to hazards that can kill or hurt you and others.

All safety messages will follow the safety alert symbol and either the word “DANGER” or “WARNING.” These words mean:

**! DANGER**

You can be killed or seriously injured if you don't immediately follow instructions.

**! WARNING**

You can be killed or seriously injured if you don't follow instructions.

All safety messages will tell you what the potential hazard is, tell you how to reduce the chance of injury, and tell you what can happen if the instructions are not followed.

## Safety

### IMPORTANT SAFETY INSTRUCTIONS

**WARNING:** To reduce the risk of fire, electric shock, or injury when using your refrigerator, follow these basic precautions:

- Plug into a grounded 3 prong outlet.
- Do not remove ground prong.
- Do not use an adapter.
- Do not use an extension cord.
- Disconnect power before servicing.
- Replace all parts and panels before operating.
- Remove doors from your old refrigerator.
- Use nonflammable cleaner.
- Keep flammable materials and vapors, such as gasoline, away from refrigerator.
- Use two or more people to move and install refrigerator.
- Disconnect power before installing ice maker (on ice maker kit ready models only).
- Use a sturdy glass when dispensing ice (on some models).

**SAVE THESE INSTRUCTIONS**

# INSTALLATION

## **⚠️ WARNING**

### **Excessive Weight Hazard**

**Use two or more people to move and install refrigerator.**

**Failure to do so can result in back or other injury.**

## **⚠️ WARNING**



### **Tip Over Hazard**

**Refrigerator is top heavy and tips easily when not completely installed.**

**Keep doors taped closed until refrigerator is completely installed.**

**Use two or more people to move and install refrigerator.**

**Failure to do so can result in death or serious injury.**

# Installation

## Packaging Examples

### Exterior Packaging

The exterior of a refrigerator is placed on a pallet, the corners covered with foam corner posts and then shrink wrapped for shipping. The edges of the doors may be protected with tape and plastic wrap to avoid surface marring. If marring does occur, follow the cleaning instructions in the Use and Care guide for the refrigerator you are servicing.



### Interior Packaging

Interior packaging is different from one manufacturing site to another. Some Top Mount refrigerators are shipped with the freezer and refrigerator door shelf components in packages located in the refrigerator section. These components must be assembled and attached to the door. Instruction sheets are included with the product to ease installation. The following pages show examples of the packaging and assembly.



Freezer Section



Freezer Door

Remove the tape, parts bundles, instruction sheets and manuals.

The glass shelves are installed upside down for shipping purposes. Follow the instruction sheet to install.

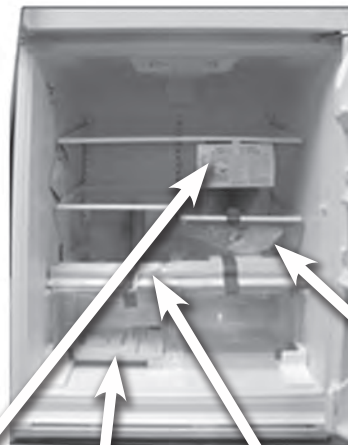



## Installation (continued)

### Installing Door Shelf Components

To install the door shelf components begin by removing all the parts from the shipping bundles. Compare the parts with the instruction sheets to make sure you have everything necessary for the installation.

Assemble the shelf components and install. If a part is missing or damaged during installation, follow normal part ordering procedures to get a replacement. Although it may be possible that a part needed for installation is missing past experience indicates this is usually caused when a part is overlooked or inadvertently discarded during installation.

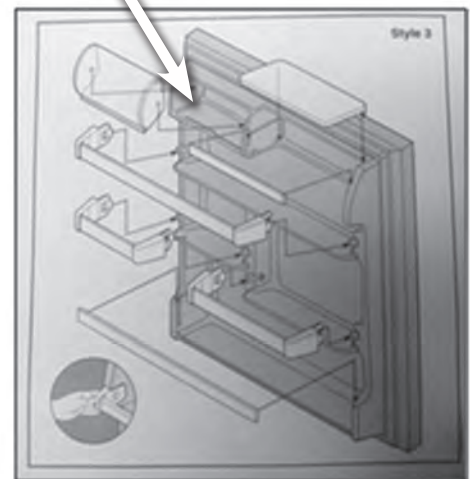
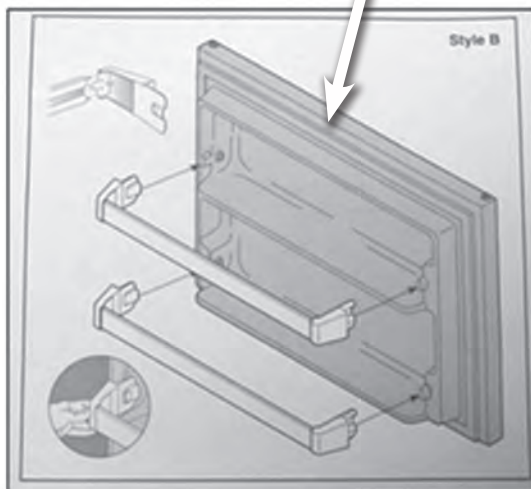
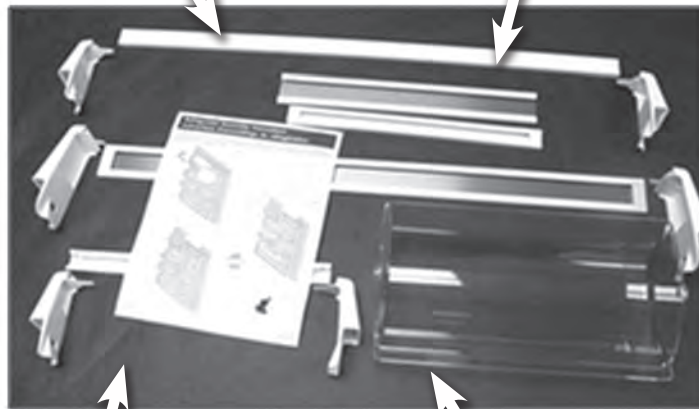

# Installation (continued)

## Leveling The Refrigerator

Refer to the Use and Care guide for detailed instructions for the refrigerator being installed. Procedure: Check the floor where the refrigerator will be installed. If the floor is not level where the rear rollers will rest, shims will be needed. Move the refrigerator into position and place the level on top of the refrigerator to check for levelness side to side and front to back. To level, begin by removing the base grill. Firmly grasp both sides of grill and pull it toward you.

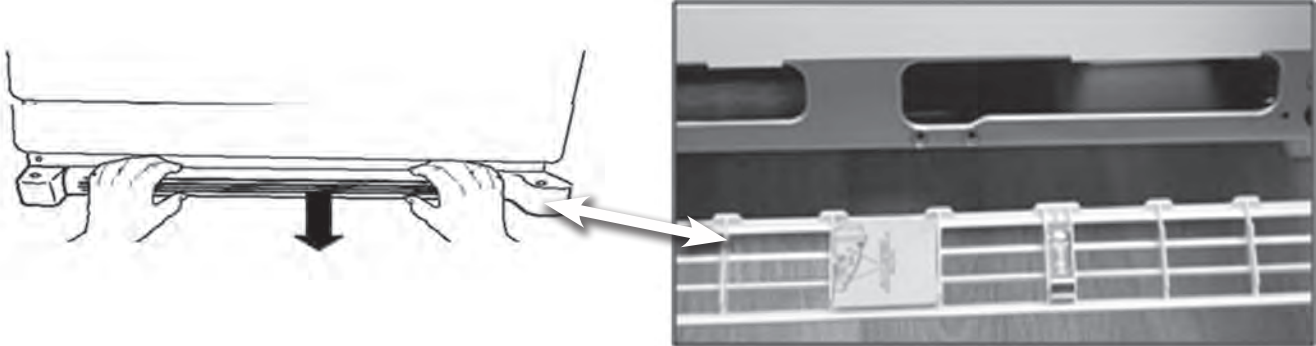

### Adjustable Front Rollers

Some refrigerators are designed with adjustable front rollers. Turning the adjustment screw clockwise forces the roller down and raises the cabinet. Turning the adjustment screw leg counter clockwise allows the roller to travel up into the cabinet and lowers the cabinet.



### Adjustable Leg Levelers

The front leveling legs screw into the front roller bracket. The leveling leg can be screwed in or out to raise or lower the cabinet. Turning the leveling leg counter clockwise lengthens the leg and raises that corner of the cabinet. Turning the leveling leg clockwise shortens the leg and lowers that corner of the cabinet.



# Installation (continued)

## Door Swing

The side of the refrigerator that has the door hinge is attached determines the door swing.

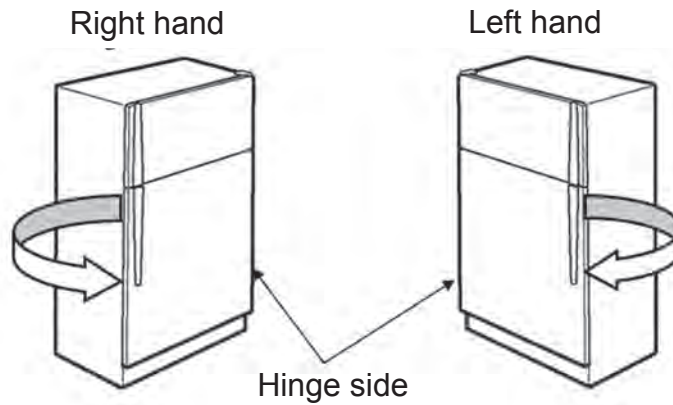

## Door reversal

Example: Door reversal instructions for a models with exterior door handles.

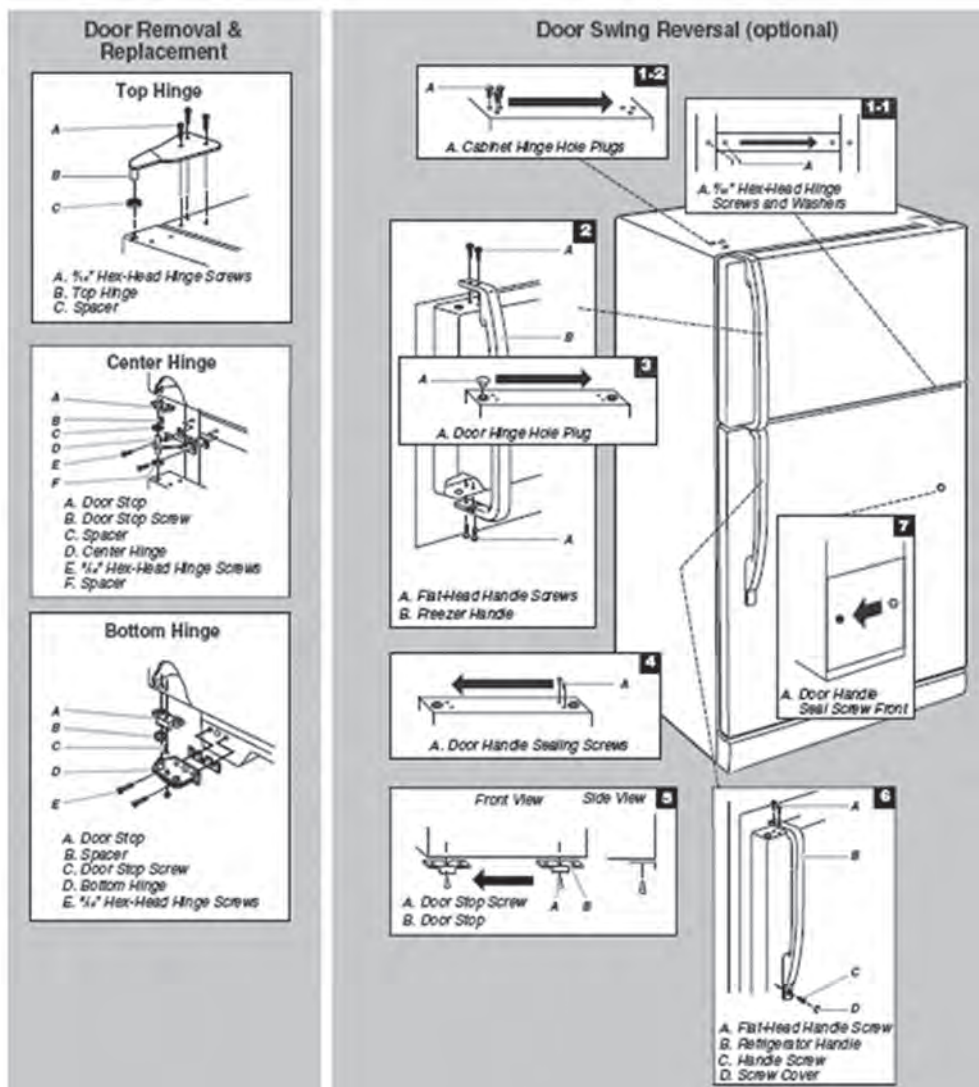

# Installation (continued)

## Door reversal –cont

Example: Door reversal instructions for contour door models with integral handles.

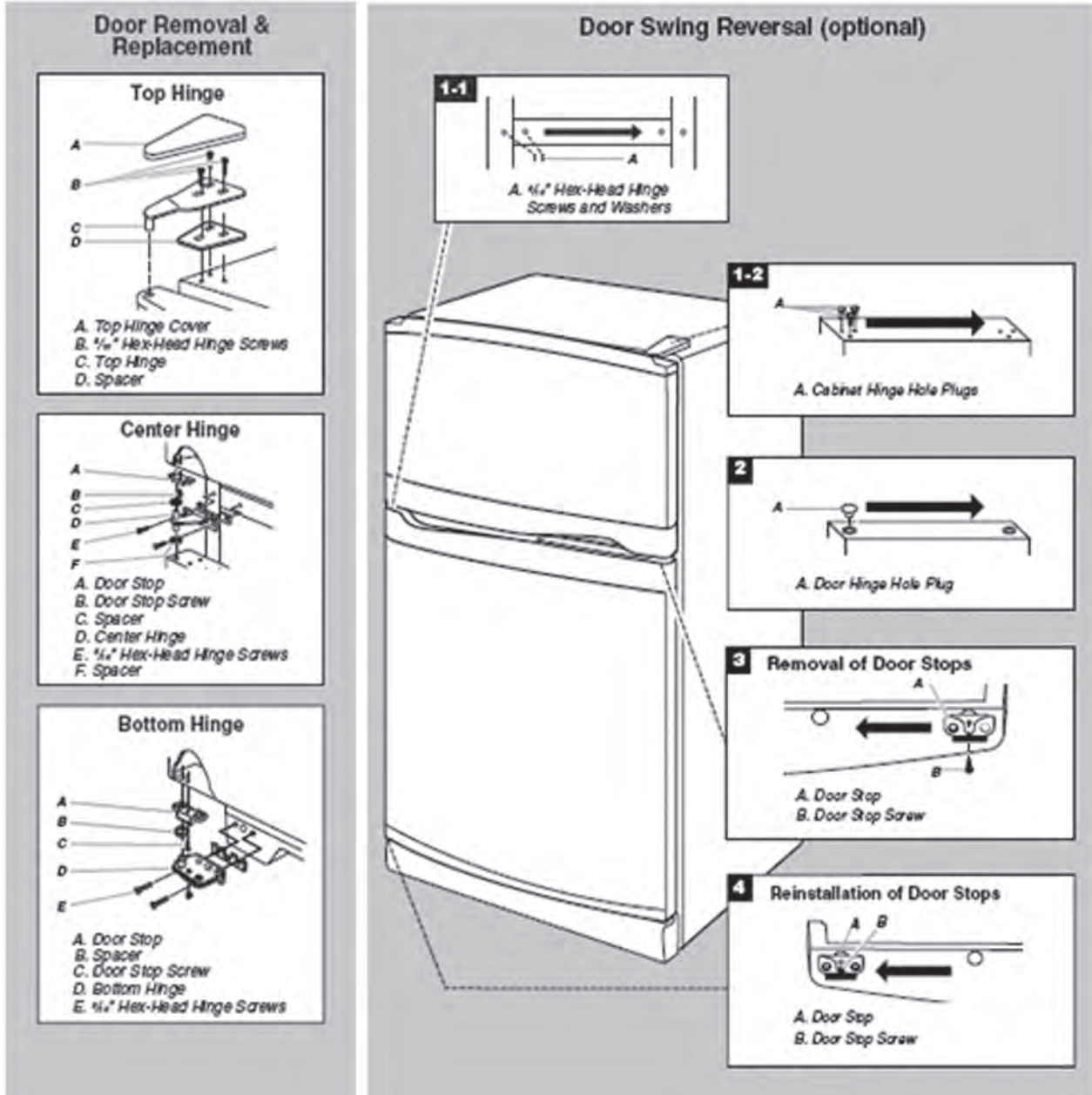

## Installation (continued)

### Connecting the ice maker water line

Water requirements

Cold water supply

Temperature above 32°

Pressure between 30-120 PSI

Must meet all local plumbing codes

Approved water supply line:

1/4" Copper tubing

Braided supply line

PEX Line – grey tubing

Note: Copper tubing is recommended

1/4" (Drill type) saddle valve

Do not use:

Plastic tubing

Self piercing saddle valve



Part # 8212547RP



Part# 8003RP

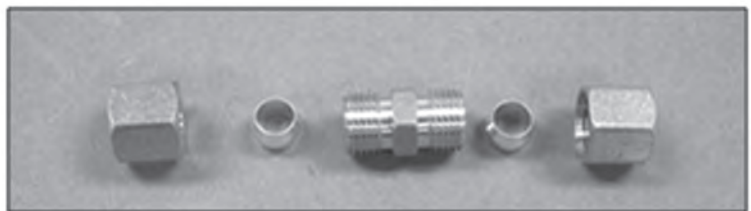

1/4" Compression union



1/4" Saddle valve (drill type)



1/4" Nut and ferrule

## Installation (continued)

### Connecting the ice maker water line



Figure 1



Figure 2



Figure 3

1. Remove valve cap, see figure 1.
2. Insert  $\frac{1}{4}$ " tubing, compression nut and ferrule into valve and hand tighten, see figures 2 and 3.
3. Tighten nut with  $\frac{1}{2}$ " wrench.
4. Remove strain relief from cabinet install on tubing and reattach to the cabinet, see figure 4 and 5.
5. Form several loops of tubing to allow for the refrigerator to be moved away from the wall, see figure 6.
6. Connect the tubing to the water supply line.  
Turn on the water and cycle the ice maker.  
Check for water leaks.  
Push the refrigerator into place.



Figure 4



Figure 5

Allow 24 hours to product first batch of ice.  
Discard first three batches of ice.



Figure 6

## Installation (continued)

### Location

<b>!WARNING</b>

<b>Explosion Hazard</b> Keep flammable materials and vapors, such as gasoline, away from refrigerator. Failure to do so can result in death, explosion, or fire.

To insure proper ventilation for the refrigerator. Allow for  $\frac{1}{2}$ " space on each side. Allow 3" of space between overhead cabinets and the top of the refrigerator. Allow a minimum of 1" between back of cabinet and wall. If the refrigerator has an ice maker, make sure to leave some extra space at the back for the water line connections.

If the refrigerator is installed next to a wall, leave 2" minimum clearance on the hinge side (depending on model) to allow for the door to swing open.

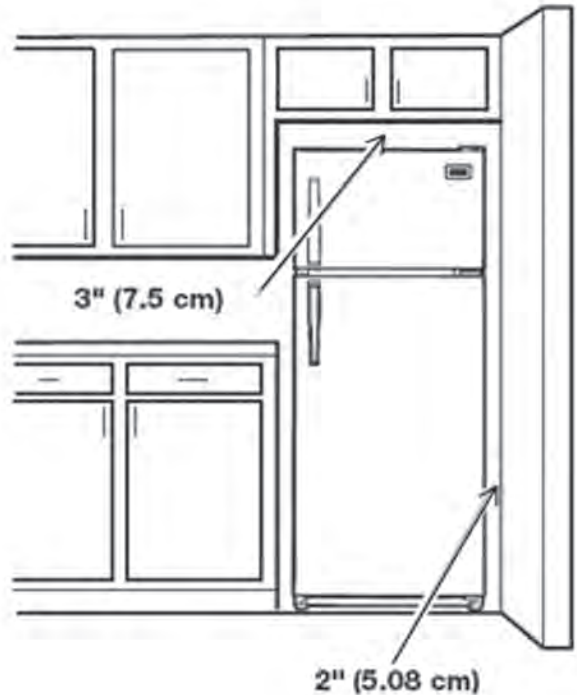
Note: Do not install the refrigerator near an oven, radiator, or other heat source, nor in a location where the temperature will fall below 55 degrees.



# Installation (continued)

## Add on ice maker kits

An add on ice maker kit is available for some models. Order the correct kit by model number.

The cover of an Installation Guide is pictured below. In this example, there are 28 pages of instructions. This kit can be installed on a variety of refrigerators; top mount and side by side models. Review the information thoroughly prior to attempting installation.

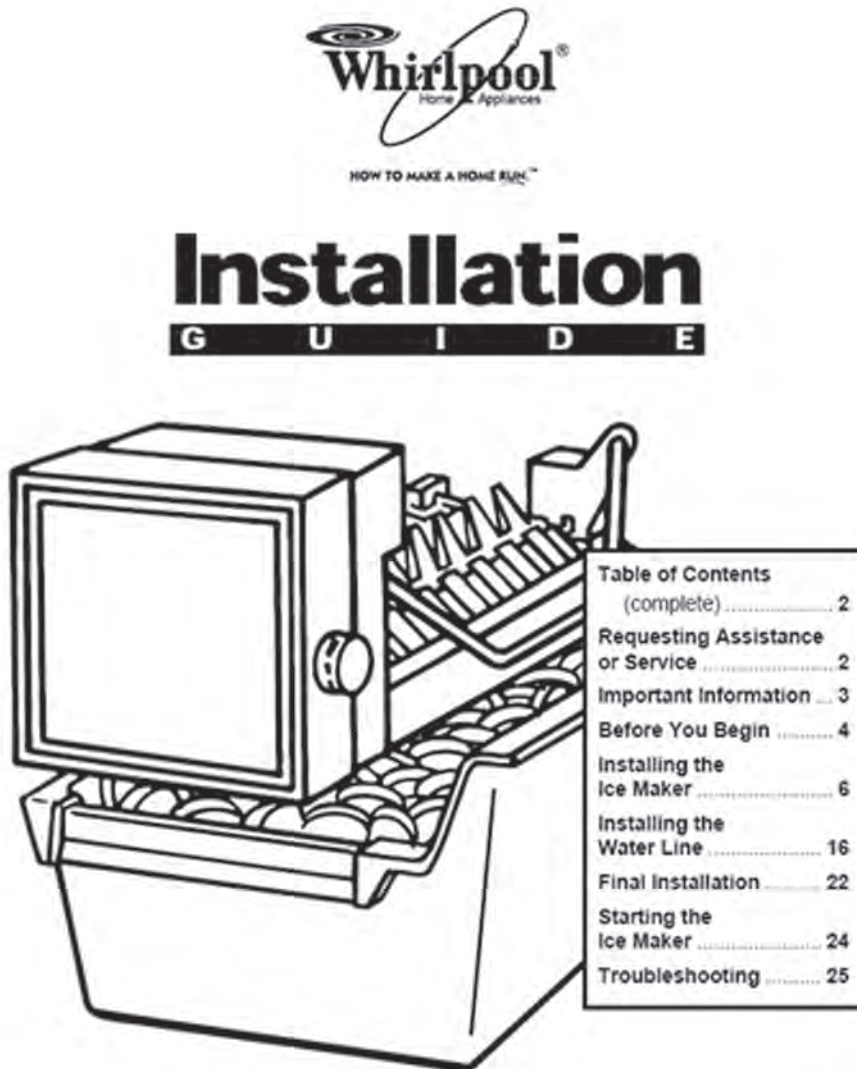

MODULAR ICE MAKER KIT



## Installation (continued)

### Add on ice maker kits

Example of components included in the kit.

KEY	QTY.	DESCRIPTION
1	1	Ice maker
2	1	Ice bucket
3	1	Water valve w/tubing
4	1	Fill tube
5	Gasket	
6	1	Short extension tube
7	1	Long extension tube*
8	2	Ice maker clips*
9	2	Tubing clips
10	1	Metal water tube insert
11	1	Water valve tubing clamp
12	4	½" hex-head sheet-metal screws
13	2	½" hex-head machine screws
14	2	¾" hex-head sheet-metal screws

\* For installation in Side-By-Side Models only.



**- NOTES -**

# THEORY OF OPERATION

## Top mount refrigerators

The term Top Mount (TM) refers to the fact the freezer section is mounted above the refrigerator section. Heat is absorbed by the evaporator inside of the freezer cabinet and transferred to the condenser outside of the cabinet for release to the ambient. The conditioned space in a refrigerator can be maintained at a temperature from +40 degrees Fahrenheit in the refrigerator section to -10 degrees in the freezer. The room temperature (unconditioned space ) could range from 50 to more than 95 degrees F. With these extremes for the unconditioned temperatures, the system needs to be designed with enough capacity for the most extreme conditions, yet provide efficient operation at what would be considered normal operating temperatures.

## Air distribution

Air is circulated across the freezer evaporator and then distributed through ducts to the refrigerator section where it picks up heat and then is circulated back across the evaporator.

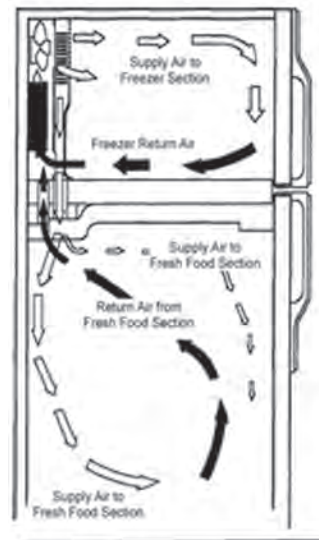

## Theory Of Operation (Continued)

### Storage of fresh foods in the refrigerator

The air in a fresh food refrigerator is always quite dry. Any moisture in the refrigerator collects and condenses on the evaporator surfaces. Therefore, food containers should be covered and as airtight as possible to keep food moist and to maintain a dry interior. The refrigerator cabinet temperature should be kept between 35°F to 41°F (2°C to 5°C).

### Storage of frozen food in the freezer

The air in a freezer, as in a refrigerator, is very dry. Any moisture in the air of the freezer quickly condenses on the evaporator surface. It is very important, therefore, that all frozen foods be packaged in moisture-resistant containers. When packaging food for the freezer, remove as much air as possible from the packaging. Hot foods should be lowered in temperature before placing them in the freezer. Frozen food packages must be tightly sealed. Ordinary paper is too porous for freezer use. If not properly packaged, frozen food will develop freezer burn.



Freezer burn is indicated by a change in color of the food. Food value is not affected, but there is a change in color and appearance. Depending on the packaging and placement of the food in the freezer some packages may experience minor thawing on the outside surface during the defrost process. This surface thawing will refreeze once defrost has completed. Repeated thawing and re-freezing of any product may result in freezer burn.

## Theory Of Operation (Continued)

### Compressor

The compressor is made up of a refrigerant pump and motor. The suction line from the evaporator empties into compressor case. The outlet of the refrigerant pump is connected to the high side line going to the condenser. All compressor motors are either a split-phase or permanent split phase capacitor run motors. There are three terminals on the outside of the case that connect internally to the motor. The compressor motor is started with a relay.



Compressor

### Evaporator

Heat is absorbed inside of the cabinet when refrigerant passes through the evaporator. As refrigerant passes from the high pressure side of the system to the low pressure side of the system, the boiling temperature drops and heat is transferred to the flowing refrigerant. Because of the cold temperatures in the conditioned space, there is very little heat available to boil refrigerant. In order to assure vaporization of refrigerant, a very low pressure must be maintained on the evaporator. At an operating temperature found in a typical freezer compartment, this low pressure is often a few pounds less than atmospheric pressure. This results in the evaporator operating in a partial vacuum.

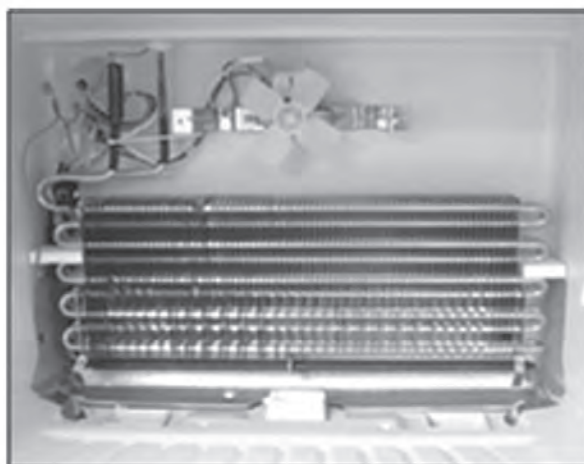

Evaporator

### Condenser

Transfer of the heat from the refrigerant to the exterior is the function of the condenser. High pressure refrigerant is cooled in the condenser and releases heat to the surrounding ambient. The condenser can be a static or forced – air coil design.



Condenser

## Theory Of Operation (Continued)

### Metering device

The capillary tube is a metering device made from a length of small diameter tubing. It connects the condenser outlet to the evaporator inlet. The cap tube restricts the flow of refrigerant between the condenser and evaporator and creates the necessary pressure difference to lower the refrigerant pressure. A filter / drier is installed just before the refrigerant passes into the capillary tube. This will help avoid clogging of the metering device and reduce the effect of any moisture that may enter the system.

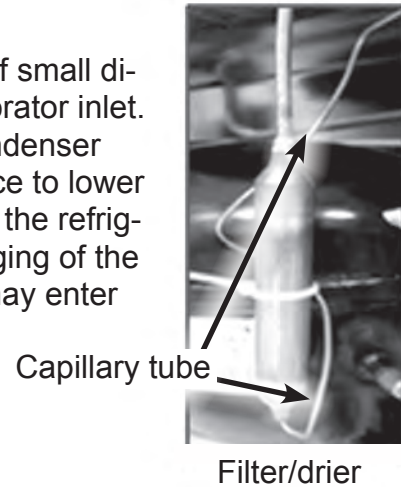

### The refrigerant system overview

The compressor and metering device set up the pressure differences required to first boil (evaporate) the refrigerant and then condense it. As cool, high pressure liquid enters the evaporator, the low pressure in the evaporator coil reduces the boiling point of the refrigerant and causes it to boil violently. As it boils, the refrigerant absorbs the heat necessary to change its state from a liquid to a vapor. The compressor draws the heated vapor from the evaporator and pushes it into the condenser under high pressure. Because the vapor enters the condenser at a faster rate than the metering device allows it to exit, pressure builds up and the vapor molecules are pushed closer together. Condensation of the vapor occurs. As the vapor condenses, the heat that was absorbed during evaporation is given off. The cool, high pressure liquid travels through the metering device and enters the evaporator where the liquid once again boils and the cycle is repeated.

### Thermostat

The temperature in a domestic refrigerator / freezer is controlled by a thermostat. The thermostat turns the compressor on or off.



Electro-mechanical thermostat

### Dampers

The amount of air flowing between the freezer compartment housing the evaporator and the refrigerator compartment is determined by a damper located in the duct. The damper can be fixed or adjustable.

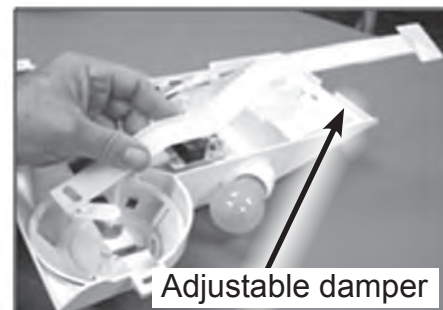

## Theory Of Operation (Continued)

### Defrost

Moisture control inside of the conditioned compartments is necessary for efficient operation. Every time a door is opened, moisture will enter the cabinet. Through either natural convection or forced air movement, the moisture will eventually condense on the coldest surface in the cabinet. The coldest surface is the evaporator. Since the evaporator in a refrigerator freezer is well below the freezing point of water, frost will form on the evaporator.

In a forced air evaporator system, the build-up of frost has severe effects. As the amount of frost builds, the airflow through the evaporator will decrease resulting in the refrigerator to run longer to achieve set temperature. If the evaporator becomes completely clogged, the airflow will stop and cooling performance will decrease to the point where the system cannot maintain the desired temperatures. In order to return cooling capacity, the frost must be removed from the evaporator.

### Automatic defrost

In an automatic defrost system, a heater and a bimetal thermostat are added to the evaporator coil. When a defrost is needed the defrost control shuts off and the compressor and the defrost heater is energized. The heater will melt the frost on the evaporator coil. The bimetal thermostat monitors the evaporator temperature and when it is heated sufficiently, the heater is shut off.

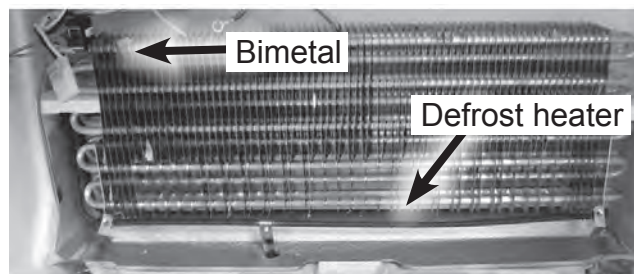

### Cabinet construction

The interior liner is made using vacuum formed plastic. The exact type of plastic will differ between manufacturers. A single sheet of material is heated until it becomes extremely pliable. A vacuum is pulled on one side of the plastic to form a large bubble. The mold is inserted into the bubble and the material is suctioned to the mold with a combination of negative pressure on the mold side of the bubble and a positive pressure on the opposite of the bubble. This type of liner provides a moisture resistant interior that will allow for a tight cabinet seal.

Expanding foam is used to fill the void between the exterior shell and the interior liner. With this type of process, all inter cavity components and interior support structures must be in place prior to the foaming process. These components include cabinet, wiring harnesses, shelf supports, heat loops and supplemental air ducting. Any component that could require replacement at a later time would require the placement of a duct to provide a channel for service. Foamed cabinet provides a more durable insulation and a rigid liner. The primary down-side of a foamed cabinet is the inability to access the components mounted between the liner and the exterior. If a wiring harness develops a problem, it is not possible to replace the harness.

# Theory Of Operation (Continued)

## Condensation control

Refrigerators have a cold interior and the exterior temperature is always warmer so there is always the possibility of condensation on the cabinet exterior. This is most likely around the doors and especially between the frozen food section and fresh food section in a refrigerator / freezer. Moisture collection on the exterior is undesirable but in certain conditions cannot be avoided. In order to reduce the moisture that collects on the exterior, most manufacturers use some form of auxiliary heat to keep the exterior surfaces free of moisture. Early condensation control consisted of low wattage electric heaters that were routed around the door openings.

## Heat loop

Top Mount refrigerators built today use heat already collected by the sealed system. A loop of steel is mounted around the door openings. After refrigerant passes through the condenser, it is routed through this loop. This warm refrigerant heats the cabinet exterior where condensation could be likely. Since the operating characteristics of a sealed system will result in higher high-side pressures as the ambient temperature increases, the temperature of the refrigerant routed through this loop will increase in warmer conditions. This type of condensation control is normally referred to as a heat loop. One drawback in using a heat loop is that if a leak develops, it cannot be repaired.

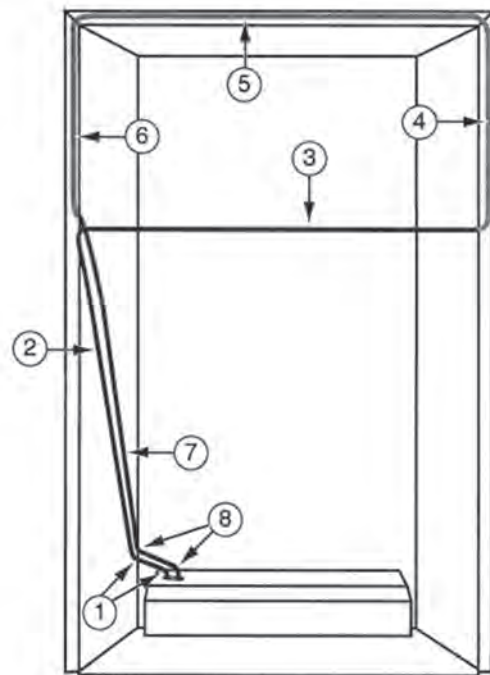

## Doors

Just as with cabinets, door construction uses foamed-in-place construction. Foamed door construction results in more rigid doors. The inside of the door is often designed with supports for the placement of storage bins. Two very common types of specialized bins are for gallons of milk or the storage of butter.





# Theory Of Operation (Continued)

## Door gasket

On most refrigerators the door sealing gasket is mounted to the door. Gaskets are pressed into a channel. Refrigerator gaskets include a magnetic strip that pulls the gasket to the face of the refrigerator cabinet. With the seal securely drawn to the metal surface, a good seal can be achieved.

If the seal on a refrigerator door is not complete, external air will enter the conditioned space. This external air will add moisture to the system and cause abnormal frosting on the evaporator. If the seal of the freezer compartment is poor, the frosting could be apparent on the cavity walls of the compartment.

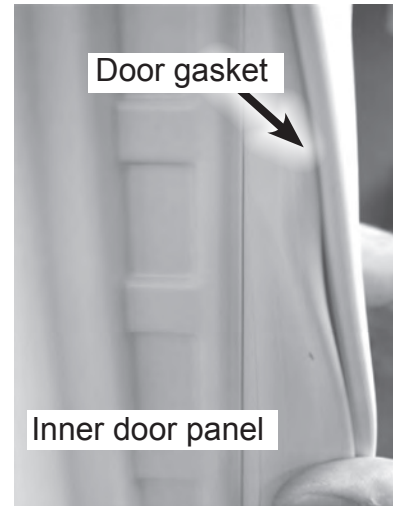

## Crispers and Humidity controlled drawers

Refrigerators include drawer compartments for the storage of produce. Since the evaporator removes moisture from the interior air, produce would quickly dry and wilt. Crisper drawers reduce the airflow around the produce and create a more humid storage location.

Most crisper drawers have some type of slide control that adjusts the amount of air that will flow through the drawer. Vegetables

are best kept at higher humidity levels than fruits. Many of these slide controls use graphics to indicate higher humidity for vegetables and lower humidity for fruits.

Some cabinets include a drawer specifically intended for meat storage. This drawer is usually located in the bottom of the fresh food section. This is the coldest portion of the fresh food section. Often a small supplemental air duct supplies cold air directly from the evaporator to this area. Meat, once thawed, can be stored at or slightly below freezing temperatures and still be ready to use.



## Ice Makers

One of the more demanded refrigerator / freezer options is an ice maker. Ice makers are self contained modules. The action of the ice maker solenoid valve is controlled by the ice maker directly. The amount of water that is used during a fill is time based. Since time is the primary factor that determines the size of the ice cubes the household water pressure is important.



# Theory Of Operation (Continued)

## Component location

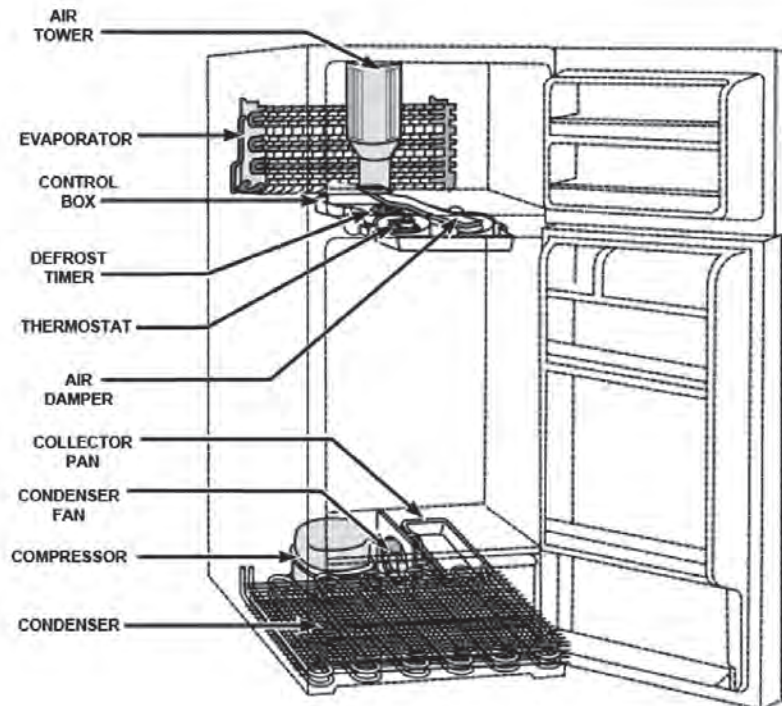
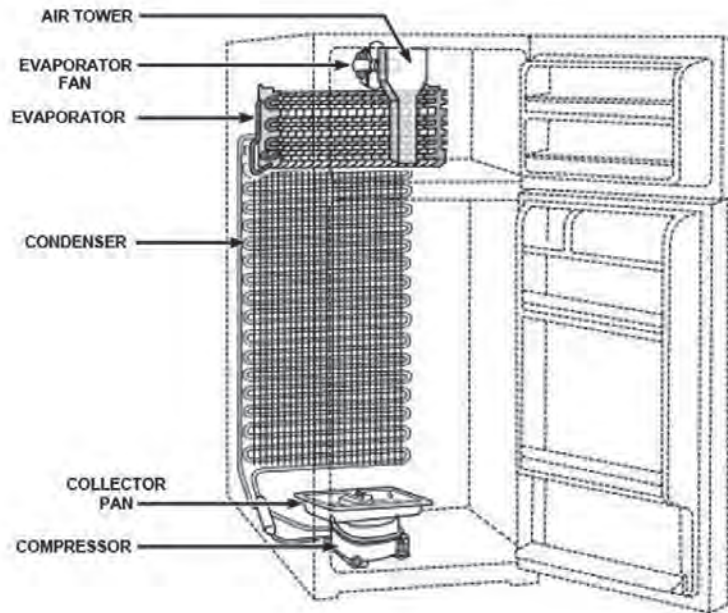

# CONTROL COMPONENTS REFRIGERATOR COMPARTMENT

## Variations Of Control Box Housings

Set all controls initially at mid setting.

Allow 24 hours run time between adjustments .



Single Knob Tapered



Single Knob Without Light Switch



Single Knob With Light Switch



Dual Knob



Dual Knob Control Refrigerator



Dual Knob Control Freezer

# Control Components Refrigerator Compartment (continued)

## Accessing Control Components .

Single knob with light switch in housing design.

<b>⚠ WARNING</b>

<b>Electrical Shock Hazard</b> <b>Disconnect power before servicing.</b> <b>Replace all parts and panels before operating.</b> <b>Failure to do so can result in death or electrical shock.</b>

1. Unplug Refrigerator or disconnect power.

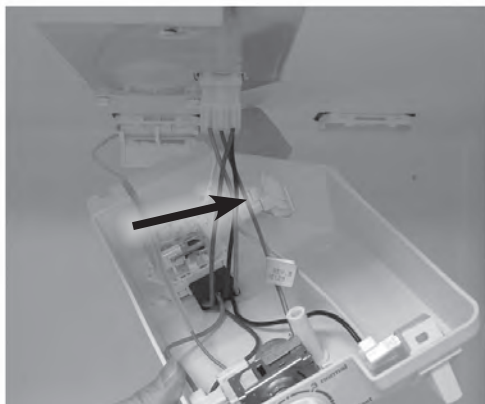

2. Drop housing down and slide the tabs on the back of the housing out of the slots.



3. Release the lock on the terminal block and disconnect the wiring harness.

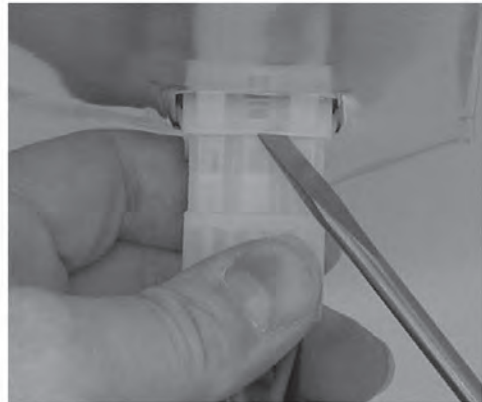

4. Remove 1/4" screw.

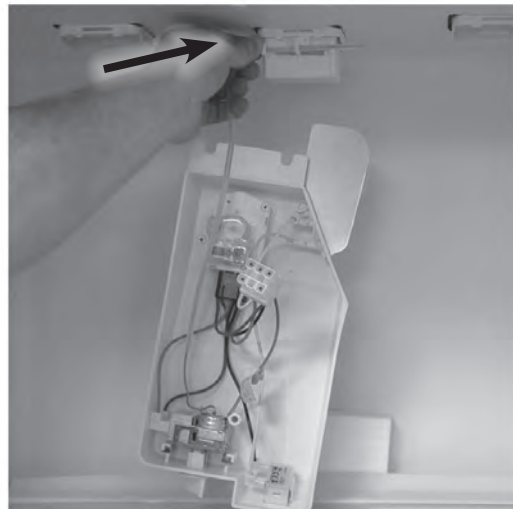

5. Disconnect the thermal bulb from the air duct.

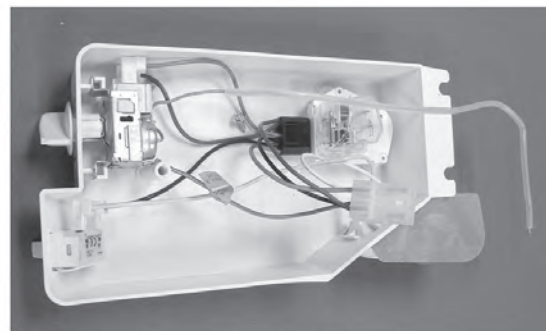

6. Remove housing.

# Control Components Refrigerator Compartment (continued)

## Accessing control components.

Single knob with air damper.



1. Remove 2-1/4" screw.



2. Drop down housing.

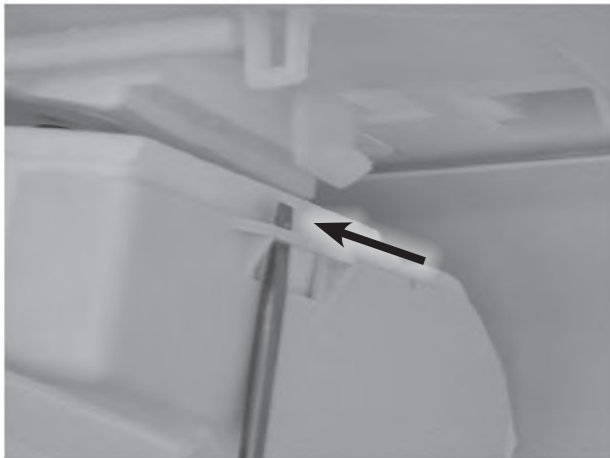

3. Unsnap tabs on sides of duct.

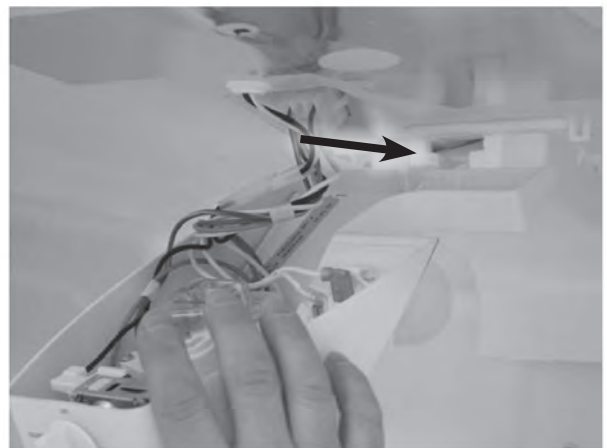

4. Remove the damper from the air duct.



5. Disconnect wire harness.



6. Remove housing.

# Control Components Refrigerator Compartment (continued)

## Accessing control components

Dual knob with adjustable air damper

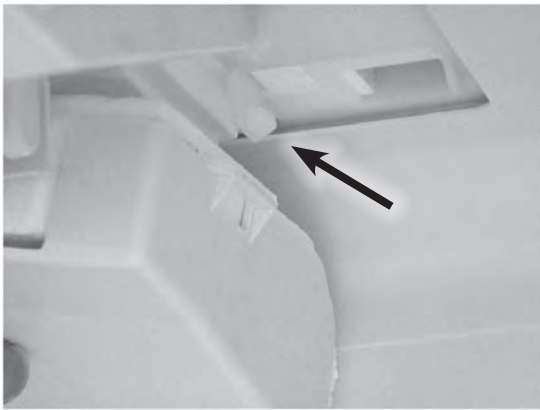

1. Release locking tabs.



2. Remove air duct.



3. Remove 2-1/4" screws.



4. Disconnect wire harnesses.

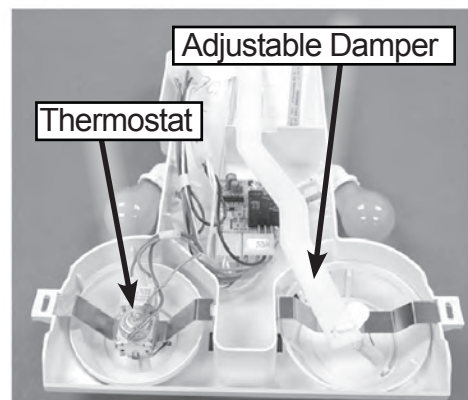

5. Remove housing assembly.

# Control Components Refrigerator Compartment (continued)

## Accessing control components

Dual knob with adjustable air damper (continued)

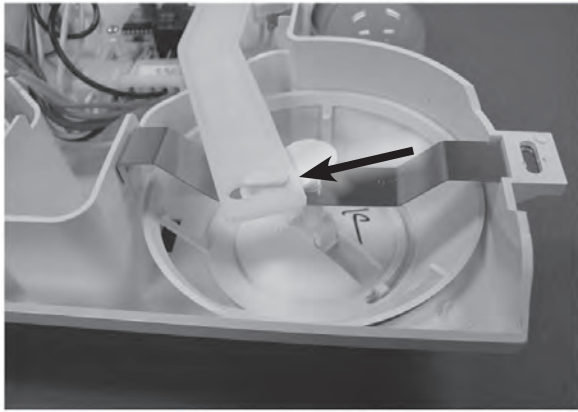

1. Align slot.

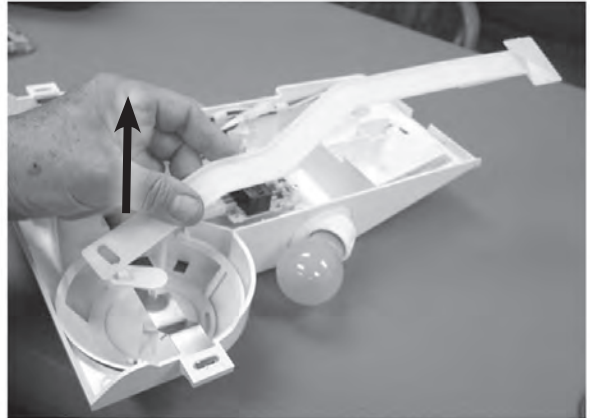

2. Lift off damper.

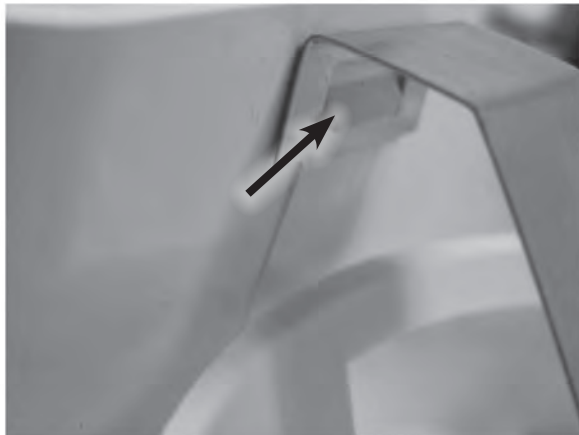

3. Release catch.



4. Lift off bracket.



5. Slide bracket off of shaft.

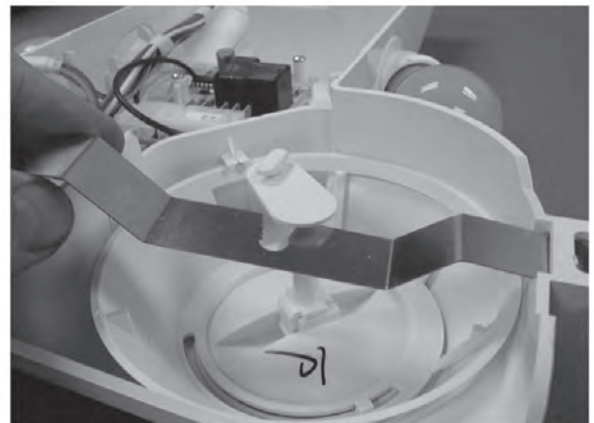

6. Remove bracket.

# Control Components Refrigerator Compartment (continued)

## Accessing control components

Dual knob with adjustable air damper (continued).  
Removing knob and shaft.

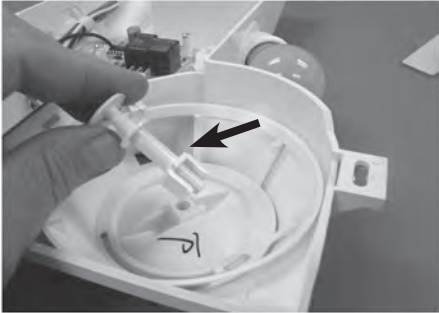

1. Remove shaft.

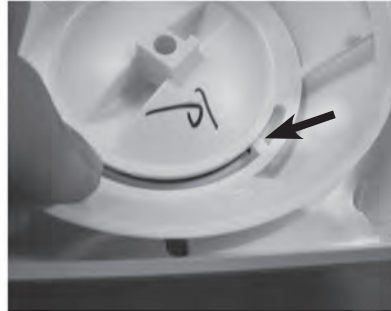

2. Release tab.

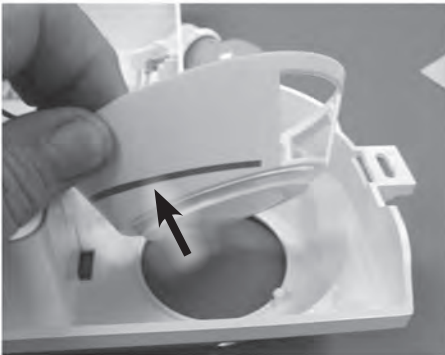

3. Lift out knob.

## Removing thermostat

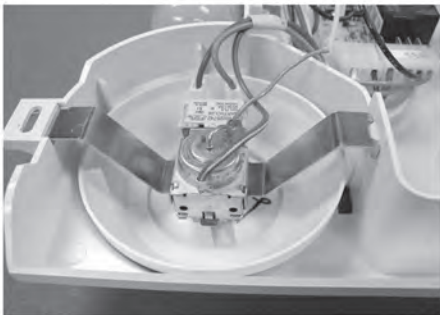

4. Release tab.



5. Release clip.

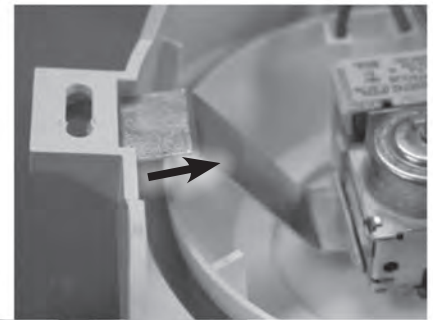

6. Slide out bracket.



# Control Components Refrigerator Compartment (continued)

## Accessing control components

Dual knob with adjustable air damper (continued).

Removing thermostat.

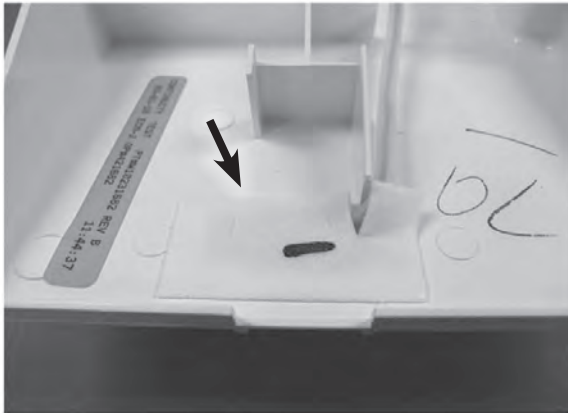

1. Thermal bulb location.

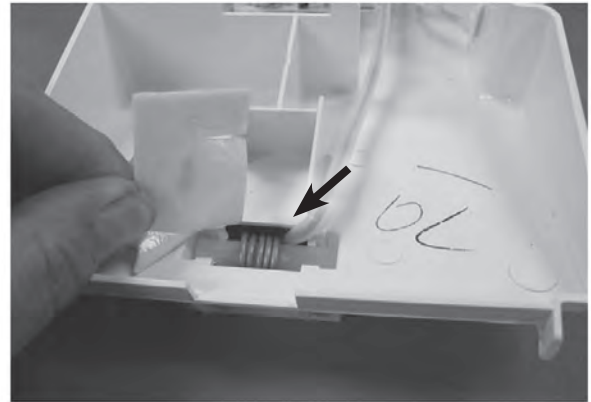

2. Peel off insulating tape.

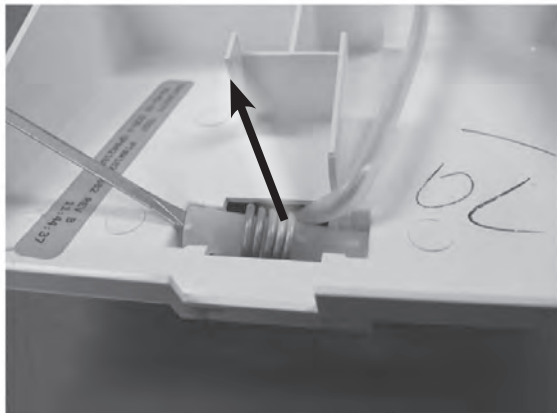

3. Remove coiled bulb from housing.



4. Pull knob off shaft.

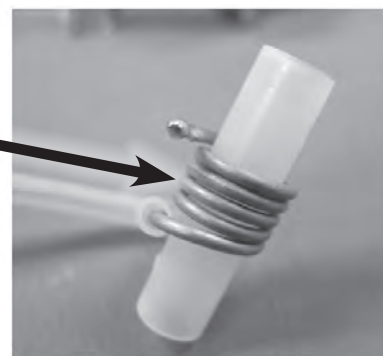
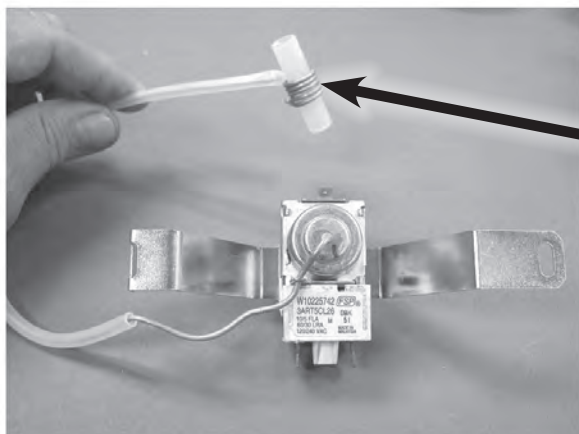

5. Coiled thermal bulb.

# Control Components Refrigerator Compartment (continued)

## Operating Thermostat

### Electro-mechanical Thermostats

Temperature control is provided by an adjustable thermostat located behind the control panel escutcheon in the refrigerator compartment. Most electro-mechanical controls indicated temperature with a range instead of a temperature. Some controls would list a range of one to five with five being coldest. This type of marking allows for individual differences without the conditioned space actually matching a pre-determined temperature

A thermostat monitors either the refrigerator or freezer compartment air temperature and energizes the compressor circuit on a temperature rise. Typically, the circuit consists of the compressor, condenser fan motor and evaporator fan motor. As the temperature of the gas inside of the sensing bulb changes, the pressure exerted by the gas upon a diaphragm in the thermostat body will change. If the gas warms enough, the gas will actuate the diaphragm and close the contacts. As the compartment cools, the pressure in the capillary will decrease, the diaphragm will relax and the contacts will open. The temperature adjustment is usually a cam that will increase or decrease the amount of pressure required to actuate the damper.



Thermostat

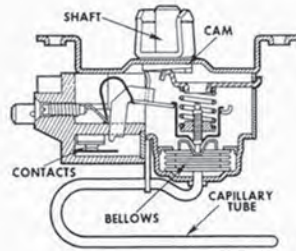

Thermostat internal components



Typical installation

To avoid the compressor short-cycling, the capillary tube is normally routed away from direct contact with the incoming freezer air. If it is routed in the air stream, many refrigerators wrap the capillary tube around a metal cylinder. The slug of metal acts as a heat sink and helps to minimize dramatic swings in the temperature sensed. If the instantaneous temperature of the interior air were measured, the thermostat would cycle the compressor every time the door was opened. The slug of metal will moderate these temperature swings and reflect a more accurate representation of the actual temperature because the capillary tube only reacts to an extended temperature change.



Capillary tube coiled around tube

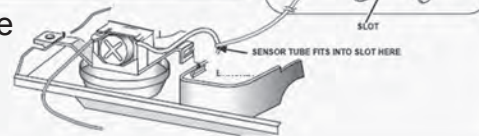
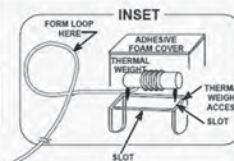

# Control Components Refrigerator Compartment (continued)

## Replacing light socket

Control -Single knob with light switch in housing

<b>⚠ WARNING</b>

<b>Electrical Shock Hazard</b> <b>Disconnect power before servicing.</b> <b>Replace all parts and panels before operating.</b> <b>Failure to do so can result in death or electrical shock.</b>

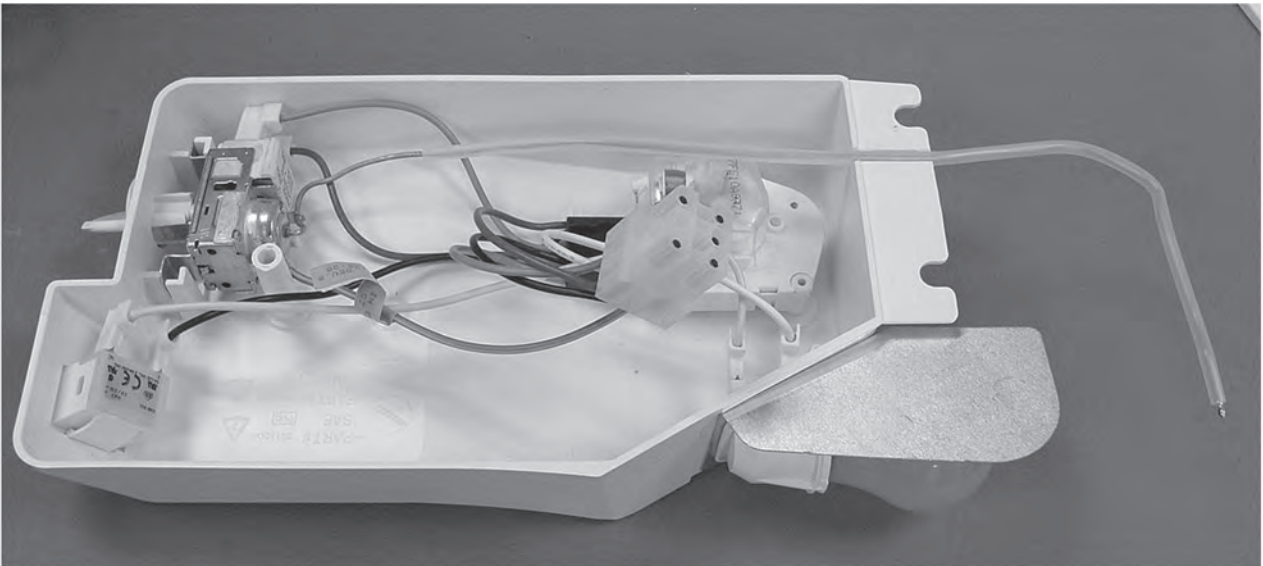
1. Disconnect power to refrigerator.

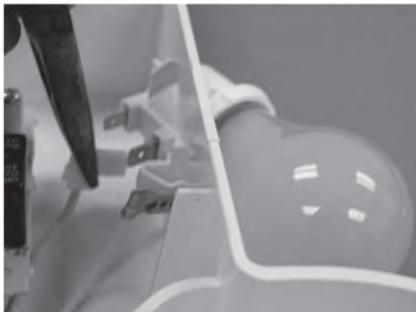

Control - Single knob with light switch in housing



2. Disconnect wires



3. Remove socket



# Control Components Refrigerator Compartment (continued)

## Light Switches

Light Switches are either located on the cabinet liner or in the control housing in the refrigerator section.

Control Box Location:

1. Disconnect power.
2. Drop the control box housing down to access the light switch.
3. Remove wires from switch.
4. Depress release tabs and remove switch.



Control box housing location

## Cabinet Wall Location:

1. Disconnect power.
2. Pry out the bottom side of the switch.
3. Remove switch and remove wires from switch.



Cabinet wall location



Switch lever depressed

## Checking Light Switch

1. Place the Ohm meter across the switch terminals.  
The meter should measure less than 1-Ohm indicating the contacts are closed.
2. Depress the switch lever.  
The meter should meter infinity indicating the switch contacts are open.

# Control Components Refrigerator Compartment (continued)

## Defrost Timers

The defrost timer controls how often the refrigerator goes into defrost. Defrosting the evaporator periodically avoids excess frost from forming and blocking air movement through the coil. The timer also limits the maximum amount of time that the defrost heater can be energized. It also establishes the maximum duration of the defrost cycle and can be connected to operate as continuous or cumulative run timers. Regardless of type, all defrost timers share common functions. First, they turn off the compressor and fans. Second, they turn on a defrost heater. The timer consists of a low torque motor, a gear and cam assembly, and a set of contacts that make and break when the cam rotates to the proper position. The gear ratio controls how often the refrigerator will go into defrost (newer design 8 hours) and the cam controls the maximum time allowed for defrost.



Defrost timer

## Mechanical Defrost Timers

The timer is made up of leaf switches that ride a cam. The motor and gear are typically configured for the internal contacts to switch from the run mode into defrost after 8 hours (current standard) of timer motor run time regardless of how the timer is wired. The switches drop into a groove in the cam and contacts #2 to #3 make. This energizes a heater that is imbedded in or positioned underneath the evaporator coil. After about 20 minutes, the timer motor advances the gear so that the leaf switch no longer sits in the groove and the contacts transfer back into the run position #3 to #4. Although the contact numbers

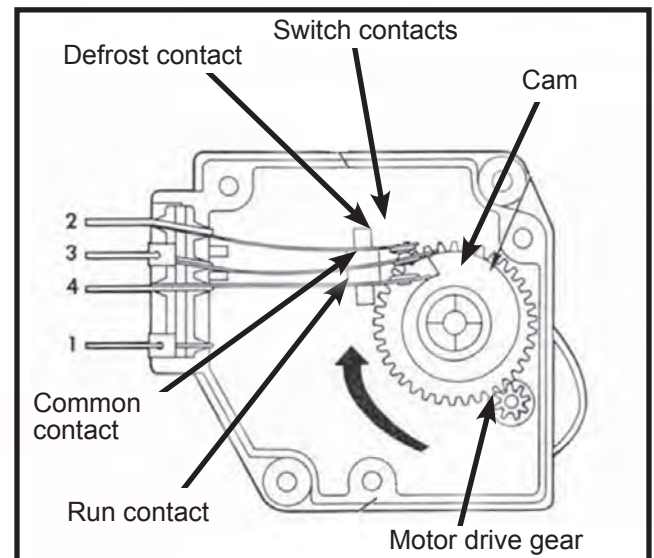

Internal components

Forcing a defrost may differ from one timer to the next, all mechanical defrost timers work on the principle described above. Most mechanical timers are equipped with a slot in the shaft of the main gear that allows the technician to manually advance the refrigerator in and out of defrost. This allows the technician to quickly check the defrost circuit provided the defrost bimetal is closed. Insert the screwdriver blade into the slot and rotate the gear clockwise until you hear a click. Continue to rotate the shaft to advance out of defrost.

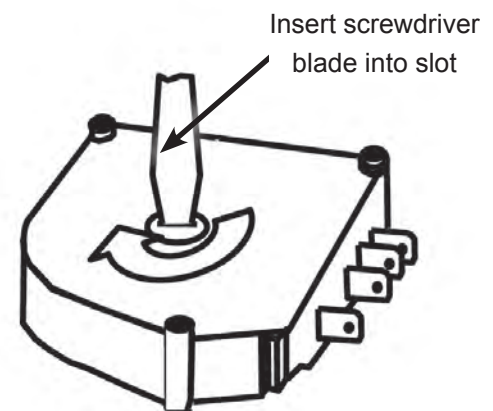

Initiating defrost

# Control Components Refrigerator Compartment (continued)

## Checking Defrost Timer

**⚠ WARNING**



### Electrical Shock Hazard

Disconnect power before servicing.

Replace all parts and panels before operating.

Failure to do so can result in death or electrical shock.

1. Disconnect power to the refrigerator.
2. Drop down the control housing as previously described.
3. Remove 2 screws securing defrost timer to housing and remove.
4. Disconnect wire harness.



Remove screws



Disconnect wire harness

# Control Components Refrigerator Compartment (continued)

## Checking Defrost Timer –Cont.

Contact #1 and Contact #2 –Defrost  
 Contact #1 and Contact #4 –Compressor  
 Note: Many new timers have a capacitor in series with the timer motor. The resistance of the motor cannot be measured as on older design timers.

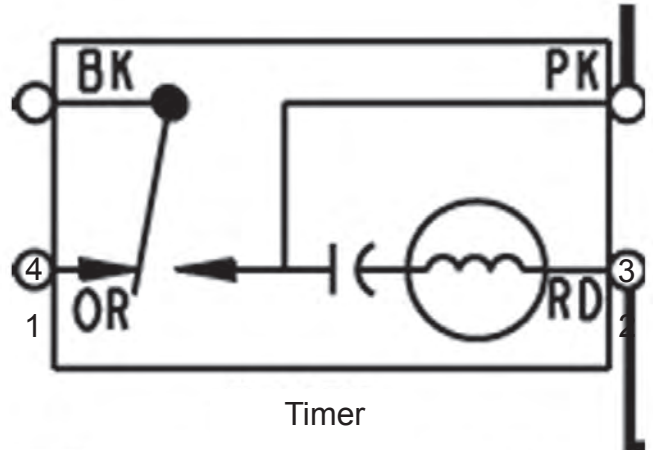

Cooling cycle  
 With the timer in the cooling position, place 1 meter lead on #1 and the other on #2. The meter should measure 0 Ohms resistance.

Cooling cycle  
 With the timer in the cooling position, place 1 meter lead on #1 and the other on #4. The meter should measure infinity.

Rotate the timer shaft until it snaps into the defrost position and recheck timer contacts.

Defrost cycle  
 With the timer in the defrost position, place 1 meter lead on #1 and the other on #2. The meter should measure infinitely.

Defrost cycle  
 With the timer in the defrost position, place 1 meter lead on #1 and the other on #4. The meter should measure 0-Ohm resistance.

# Control Components Refrigerator Compartment (continued)

## Defrost timer wiring configurations

There are two timer wiring configurations used on refrigerators:

- Continuous run
- Cumulative run

Continuous Run Timers get their name from the fact that the timer motor is wired across the line and is energized any time that power is applied to the refrigerator. During the cooling cycle, power to the operating thermostat, compressor and fans is supplied through the normally closed contacts of the timer. Once in defrost, the contacts on the timer switch, the thermostat is disabled and the heater is energized. Once the coil reaches a predetermined temperature (normally 50 -60 degrees) the defrost bimetal or terminator opens and the heater is turned off. The timer continues to run until the cam advances out of the defrost position (approximately 20 minutes) and the contacts are switched back to the cooling mode. Typically, a continuous run timer will cycle the defrost heater every eight hours, regardless of the operating conditions of the refrigerator.

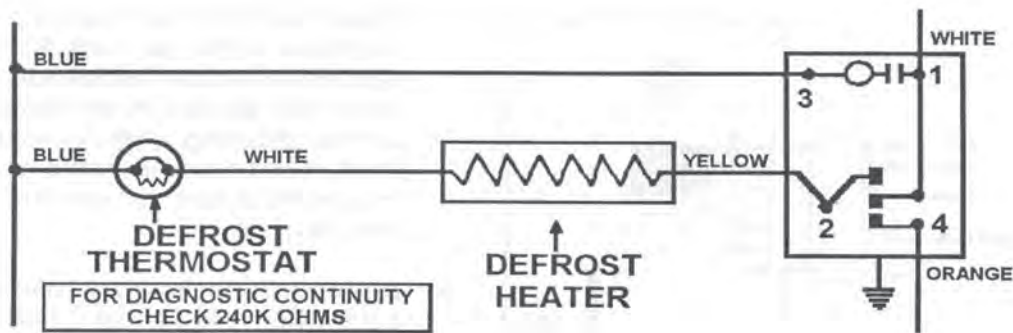

When wired as a cumulative run timer, the timer motor is energized only when the operating thermostat is calling for cooling. When the thermostat contacts close, a parallel circuit provides line voltage to both the timer motor and the compressor and fans. The timer motor picks up the neutral side of the line through the bi-metal and heater. Because of the high resistance of the motor coil (when compared to the resistance of the heater), most of the voltage will drop across the motor coil. The current in the circuit will be limited by the combined resistance of the motor and heater and will avoid generating more than a few watts. After eight hours of compressor run time, the defrost timer will have accumulated enough run time to advance the internal cam into defrost. At that point, the operating thermostat and the contacts are disabled on the timer switch. A different parallel path is established and full power is applied to the heater. The timer motor now uses the run winding of the compressor for its return to the neutral side of the line. Thus, it can be said that cumulative run timers rely on compressor run time to determine how often to defrost. The logic behind tying defrost to compressor run time is that, for the most part, frost only forms on the evaporator when the compressor and fans are operating. The longer the compressor runs, the more frost is formed and the sooner the evaporator needs to be defrosted. Conversely, if the usage is very light, very little frost is formed and the need for defrost is reduced.



# Control Components Refrigerator Compartment (continued)

## Dwell time

Dwell time is also referred to as “drip time” –it’s the length of time between the defrost heater shutting off and the compressor starting. During dwell, the defrost water drips off the evaporator onto the drain pan and exits the drain tube. (This allows the defrost water to drain before the water freezes). The length of the dwell varies from 3 to 10 minutes depending on the design of the evaporator and the defrost system.

## Adaptive defrost theory

In order to properly cool over a long period of time, the evaporator coil in a refrigerator must be defrosted. Each defrost cycle wastes energy. During the defrost cycle energy is used to heat the evaporator coil. This heat must be removed from the freezer compartment after the defrost cycle by the sealed system.

Many refrigerators automatically defrost according to a set schedule. Most refrigerators measure run time between each defrost cycle while others measure total time between defrost cycles. Both of these methods fail to take into consideration the use of the refrigerator and the ambient conditions.

In more humid periods or climates, there is more moisture available to build frost on the evaporator and defrosting will be required more often. In drier periods or climates, less frost will form on the evaporator and the need for defrost is decreased.

If the door is opened often, more moisture will be allowed to enter the cabinet and the need for defrost increases. If the door is seldom opened, less moisture is available to form frost on the evaporator and the need for a defrost cycle is decreased.

The determination for a successful defrost is the opening of the defrost terminator thermostat. This thermostat will open at a temperature that should ensure that all frost has been melted from the evaporator. The more frost that is on the evaporator, the longer it will take for the defrost termination thermostat to open. If there is less frost on the evaporator, the defrost termination thermostat will open sooner in the defrost cycle. By measuring the time it takes for the defrost termination thermostat to open after the start of the defrost cycle, the amount of frost actually present on the coil can be indirectly measured.

If too much frost is allowed to build up on the evaporator, the cooling system becomes less efficient. If a defrost cycle is initiated before it is really needed, energy is wasted during an unnecessary defrost cycle. The optimum duration for a defrost cycle has been determined to be approximately fifteen minutes. The target of the controller is to vary the compressor run time between defrost cycles so that the defrost termination thermostat will open when the optimal defrost duration is reached. Example; Testing might determine that the ideal defrost cycle for a particular design might be 15 minutes. When first powered up, the compressor run time before the first defrost is preprogrammed to a fixed compressor run time. Example, 6 hours.

The control board monitors the amount of time from the start of the defrost cycle until the defrost termination thermostat opens. For every minute less than the optimal target defrost duration, additional time is added to the accumulated run time before the next defrost. For every minute over the optimal target defrost duration, additional time will be subtracted from the accumulated run time before the next defrost cycle.

# Control Components Refrigerator Compartment (continued)

## Adaptive Defrost Control –cont.

The ADC control was developed to replace the standard mechanical timer to reduce energy consumption by optimizing defrost time. This electronic control can be damaged by electrostatic discharge.

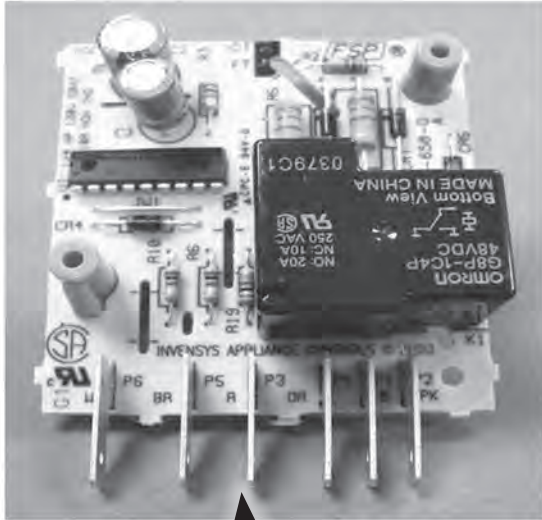

Electrostatic discharge sensitive electronics

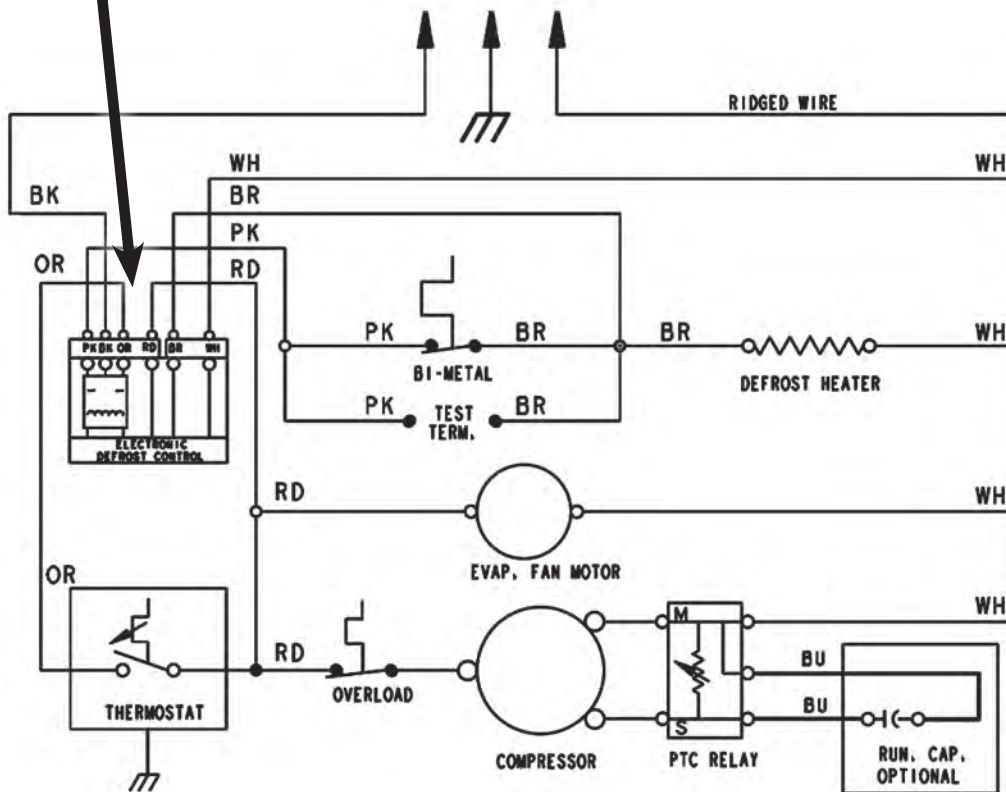

Example: Schematic of TM refrigerator with ADC control

# EVAPORATOR COMPONENT IDENTIFICATION, ACCESS AND TROUBLESHOOTING

## Removing Evaporator Cover

<b>⚠ WARNING</b>

<b>Electrical Shock Hazard</b> Disconnect power before servicing. Replace all parts and panels before operating. Failure to do so can result in death or electrical shock.

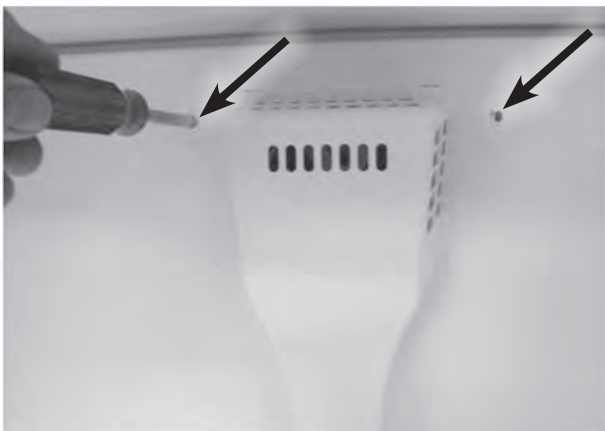
1. Disconnect power to the refrigerator.  
Remove the ice maker if so equipped.



2. Remove the two 2-1/4" screws securing the evaporator cover to the cabinet wall.



3. Disconnect the green chassis ground wire.  
**Note:** Always connect ground wire when assembling

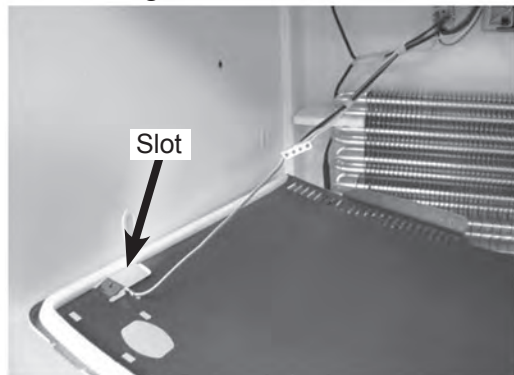

4. Pull the top of the evaporator cover down and feed the ice maker wire harness through the slot in the cover.

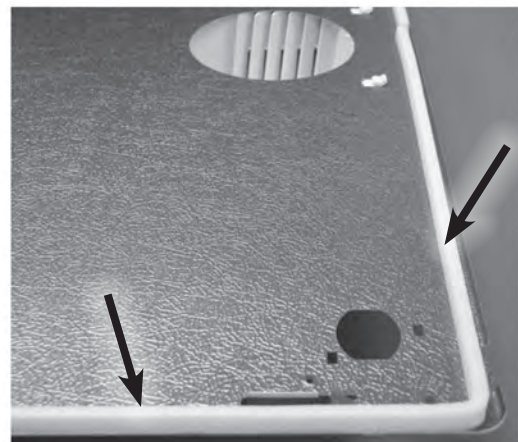

5. Inspect gasket / seal replace if damaged.

# Evaporator Component Identification, Access and Troubleshooting (continued)

## Evaporator Cover Replacing Air Tower

### **⚠ WARNING**



#### **Electrical Shock Hazard**

**Disconnect power before servicing.**

**Replace all parts and panels before operating.**

**Failure to do so can result in death or electrical shock.**

1. Disconnect power to refrigerator. \_\_\_\_\_

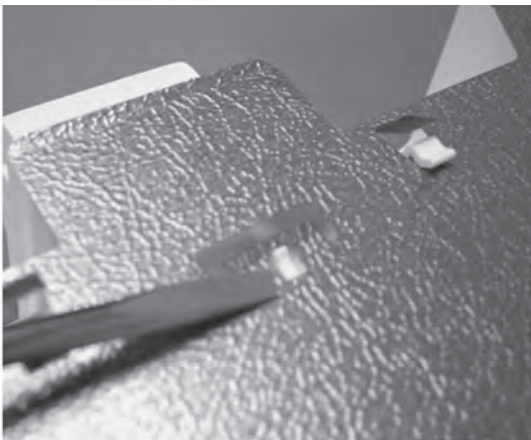

Locate the locking tab protruding through the cover.

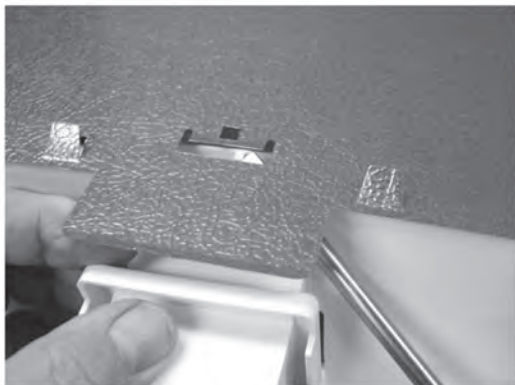

2. Use a straight blade screwdriver to lift cover and disengage the locking tab.

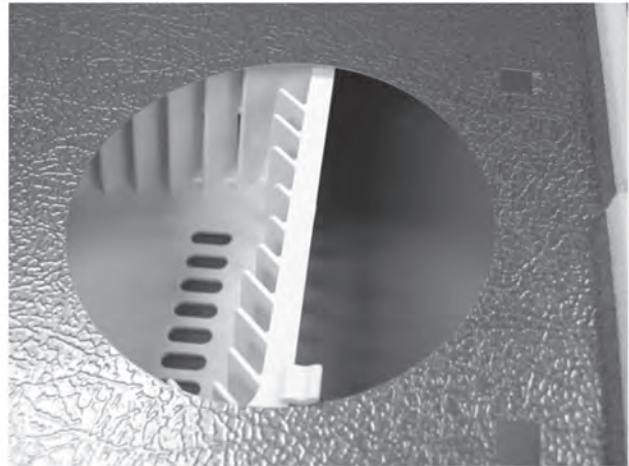

3. Remove the cover.

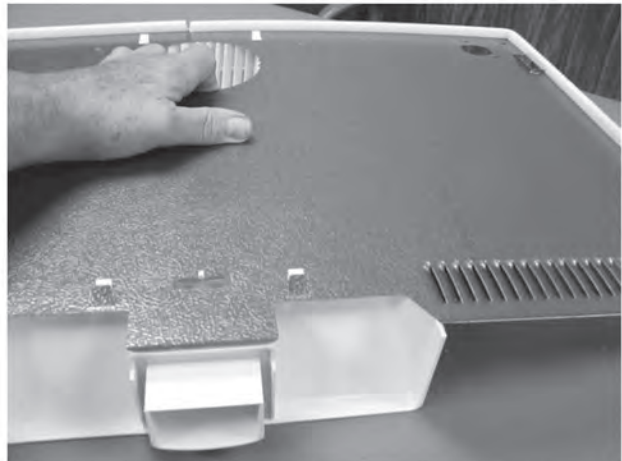

4. Slide the cover to align the tabs with corresponding slots in the cover.



Air Tower

# Evaporator Component Identification, Access and Troubleshooting (continued)

## Accessing Evaporator Components 2 Piece Evaporator Cover

### **! WARNING**



#### **Electrical Shock Hazard**

**Disconnect power before servicing.**

**Replace all parts and panels before operating.**

**Failure to do so can result in death or electrical shock.**

1. Disconnect power to refrigerator.
  2. Remove the ¼" screw securing the water tube cover to the main cover and remove. See figure 1.
  3. Disconnect the green chassis ground wire from the main cover. See figure 2.
- Note:** Always connect all ground wires when assembling.
4. Remove 2-¼" screws securing the lower cover to the main cover. See figure 2.
  5. Remove lower cover. See figure 2.
  6. Remove the foam ducts, see figure 3.
  7. Pull the top of the main cover outward and remove. See figure 3.

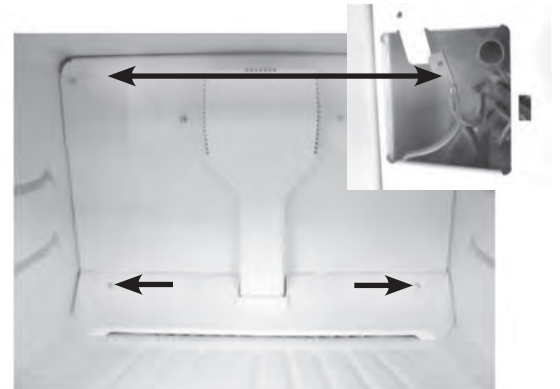
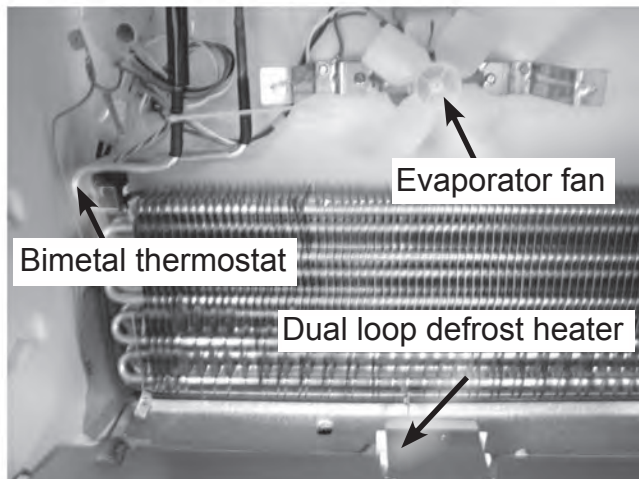

Figure 1

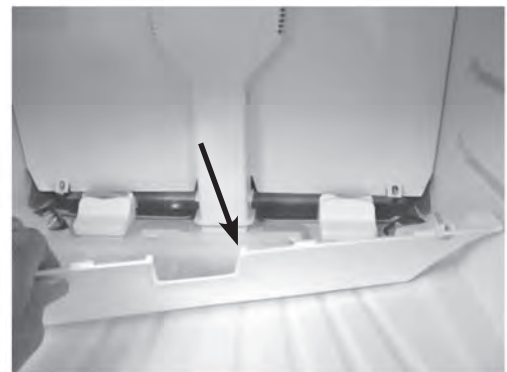

Figure 2



Figure 3

# Evaporator Component Identification, Access and Troubleshooting (continued)

## Defrost Heaters

Defrost heaters are high wattage electrical elements that generate a great deal of heat when power is applied to them. When energized, the heater melts any frost that has accumulated on the evaporator coil. Defrost heaters come in two varieties:

Calrod heaters are similar to the spiral burners found on electric ranges.

Some older refrigerators were produced with glass enclosed heaters.

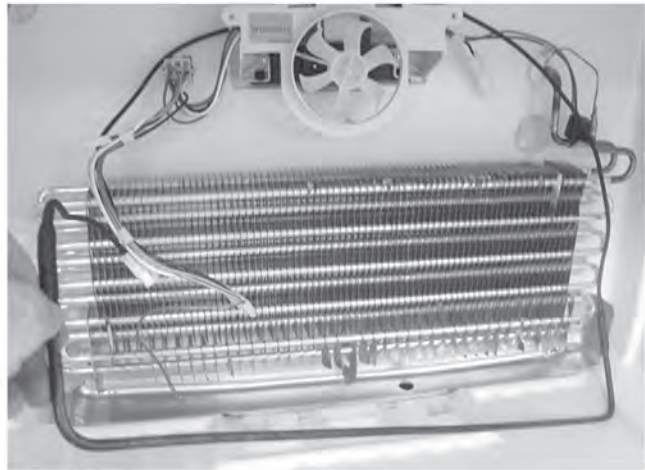

Example: Top mount single loop heater.

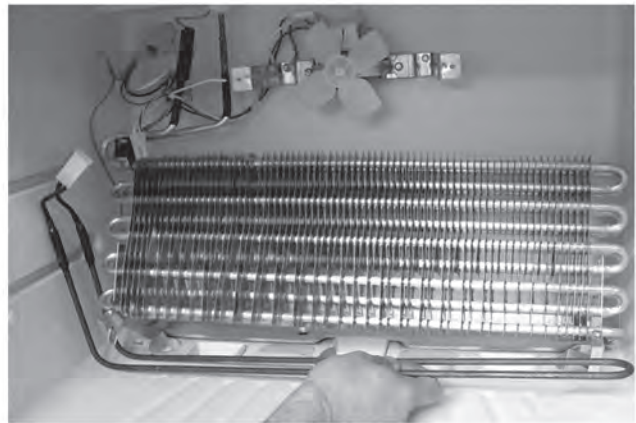

Example: Top mount dual loop heater.

# Evaporator Component Identification, Access and Troubleshooting (continued)

## Checking Defrost heater

**⚠ WARNING**



### Electrical Shock Hazard

**Disconnect power before servicing.**

**Replace all parts and panels before operating.**

**Failure to do so can result in death or electrical shock.**

1. Disconnect power to the refrigerator
2. Remove the evaporator cover as explained previously.
3. Disconnect the wiring harness see figure 1.
4. Connect the meter leads across the heater terminals. Compare the measured reading with specification on the Tech Sheet shipped with the refrigerator, in this example the resistance for the installed heater is 30 Ohms and 33 Ohms for the uninstalled heater. See figures 2 and 3.
5. Connect one meter lead to a heater lead and the other meter lead to the heater sheath, see figure 4. The meter should measure infinity indicating that the heating element is not shorted to the sheath.

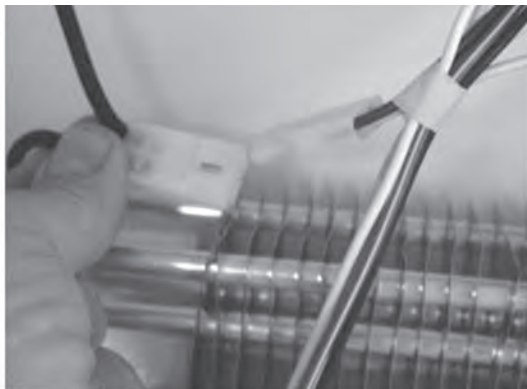

Figure 1



Figure 2



Figure 3



Figure 4

## Evaporator Component Identification, Access and Troubleshooting (continued)

### Removing the defrost heater.

1. Remove the evaporator cover as explained previously.
2. Remove the foam blocks located on the left and right side of the evaporator, see figure 1.

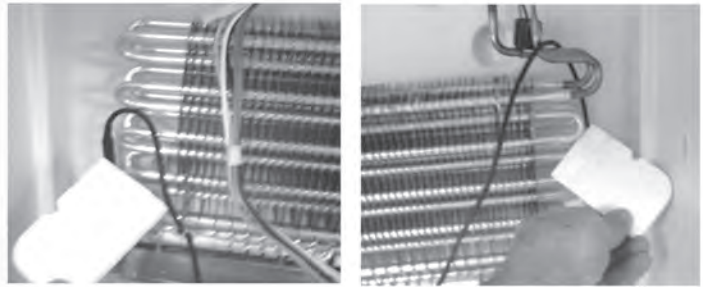

Figure 1

**Note:** Always install the foam blocks when assembling. Failure to do so will decrease the cooling efficiency of the refrigerator.

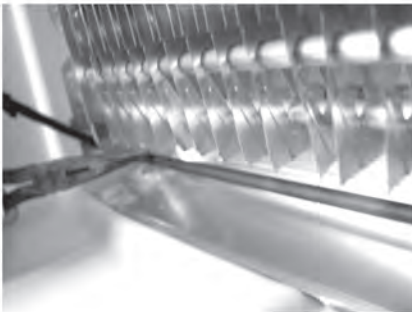

Figure 2



Figure 3

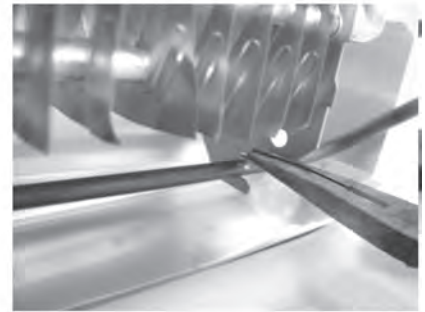

Figure 4

Aluminum tabs located on the left side, middle and right side of the evaporator secure the heater to the evaporator. Bend these tabs to release the heater. See figures 2, 3 and 4.

3. Remove the defrost heater from the evaporator, see figure 5.

**Note:** When installing the heater, make sure the aluminum tabs are holding the heater tight against the evaporator to promote good heat transfer.

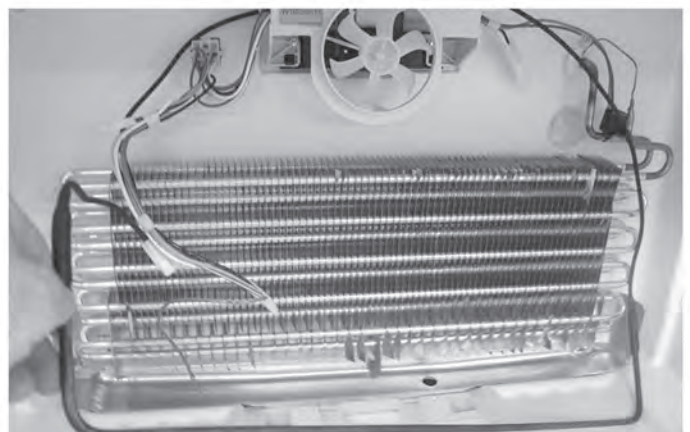

Figure 5



# Evaporator Component Identification, Access and Troubleshooting (continued)

## Defrost Bimetal

The purpose of the defrost termination thermostat is twofold: First, it avoids the defrost heater from energizing unless the freezer is at the correct temperature. More specifically, the thermostat senses the temperature of the evaporator coil and completes the circuit to the heater only if the coil is around 5° F or lower. Second, it opens the circuit to the heater at the completion of the defrost cycle. The defrost termination thermostat utilizes a bimetal disk to sense temperature. The disk is made of two dissimilar metals that expand at different rates. When exposed to temperature changes, the disk warps, making or breaking a set of electrical contacts.

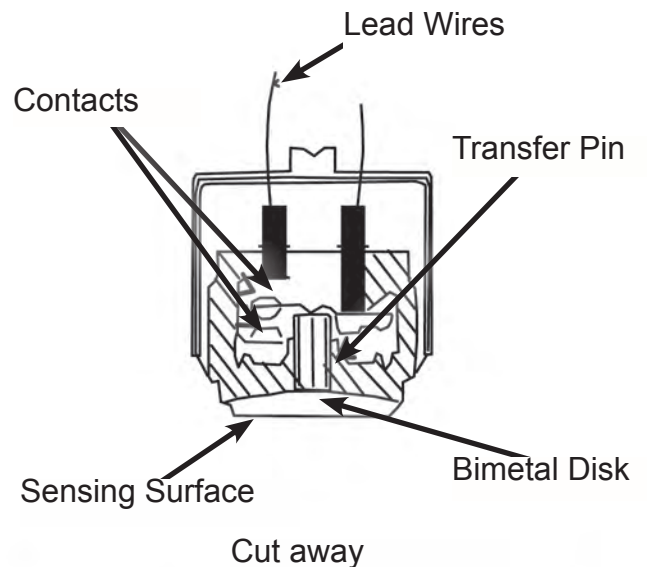

Even though the defrost timer allows a maximum defrost of about 20 minutes, the length of defrost actually depends on the amount of frost on the evaporator. As soon as the bimetal senses that the coil temperature is somewhere between 45-60° F, the bimetal disk warps and opens the internal contacts and the heater is disabled. The heavier the frost, the longer it takes for the frost to melt and for the bimetal to open. Once the bimetal opens, the defrost cycle continues with no heat until the defrost timer cycles back into the cool mode. This allows the defrost water to drain completely before the compressor is energized and brings the evaporator back down to freezing temperatures.

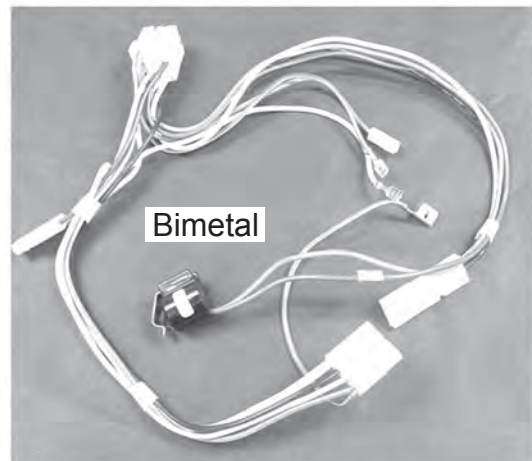

Service bimetals with wire harness

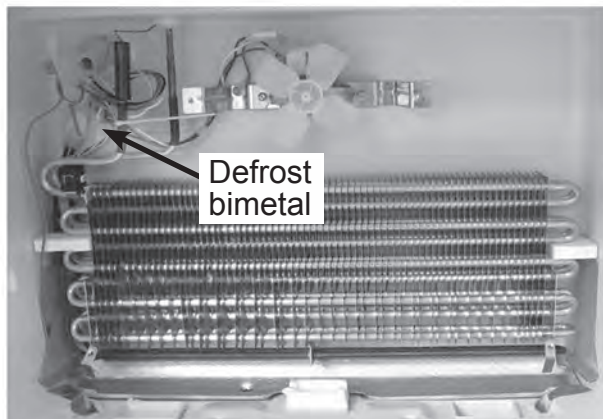

Example -Top Mount Bimetal location

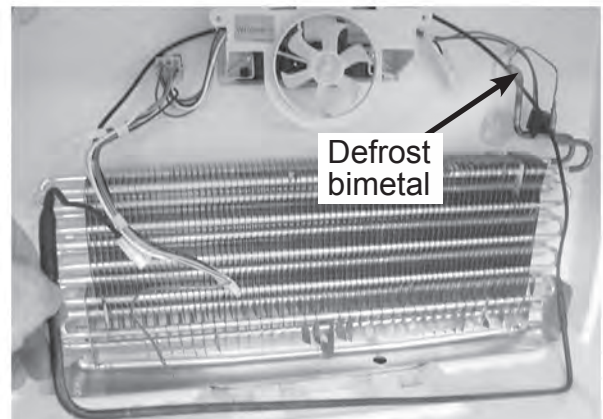

Example -Top Mount Bimetal location

# Evaporator Component Identification, Access and Troubleshooting (continued)

## Checking Defrost Bimetal

### **! WARNING**



#### **Electrical Shock Hazard**

**Disconnect power before servicing.**

**Replace all parts and panels before operating.**

**Failure to do so can result in death or electrical shock.**

1. Disconnect power to the refrigerator.
2. Remove the evaporator cover as explained previously.
3. Disconnect the wiring harness.  
Connect the meter leads across the bimetal terminals.
  - a. If the bimetal is warm the meter should measure infinity indicating that the bimetal thermostat is open.
  - b. If the evaporator is frosted over and the bimetal is below 40 degrees, the meter should measure less than 1-Ohm indicating that the bimetal thermostat is closed.



# Evaporator Component Identification, Access and Troubleshooting (continued)

## Evaporator Fan Motors

The purpose of the fan motor is to circulate air inside the freezer and refrigerator compartments. Evaporator motors are very low wattage energy efficient devices. Motors are located on top of the evaporator mounted in an enclosed shroud or on a bracket.

There are two types of motors used, the old standard shaded pole design or the newer high efficiency stepper motor. Both types of motors develop very little torque and normally will not be damaged if the blade is kept from turning.

A shaded pole motor is a simple coil design with a shading coil used for starting torque and to establish the direction of rotation. A stepper motor incorporates a small electronic control board inside the housing. A resistance check cannot be made on a stepper motor.

One way to determine if the motor is shaded pole or a stepper design is to spin the blade. The blade on a shaded pole motor will rotate smoothly and slow gradually. A stepper mo-

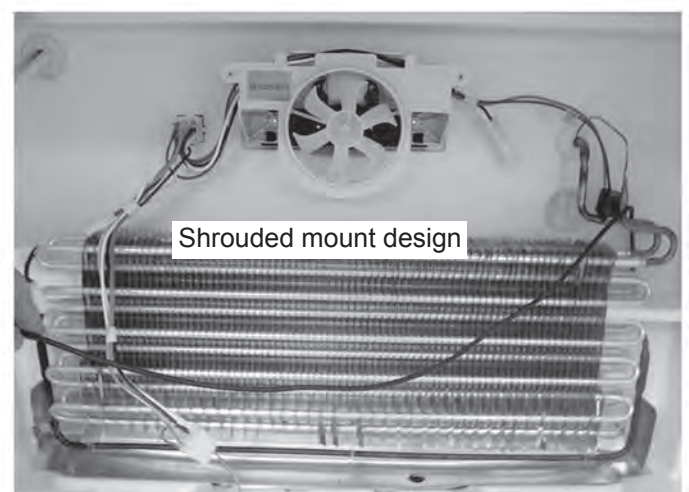
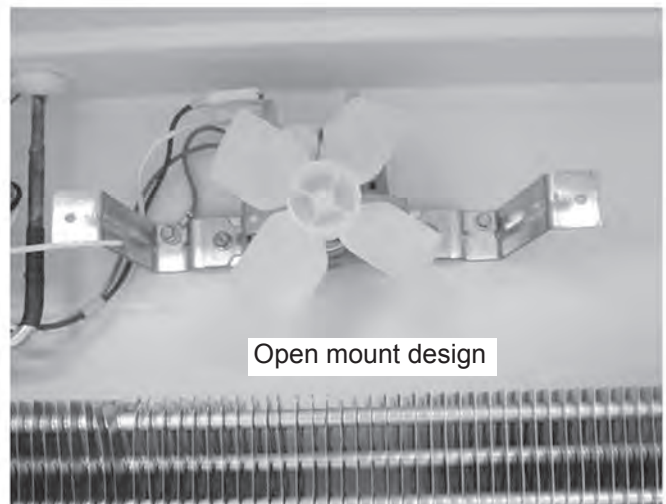
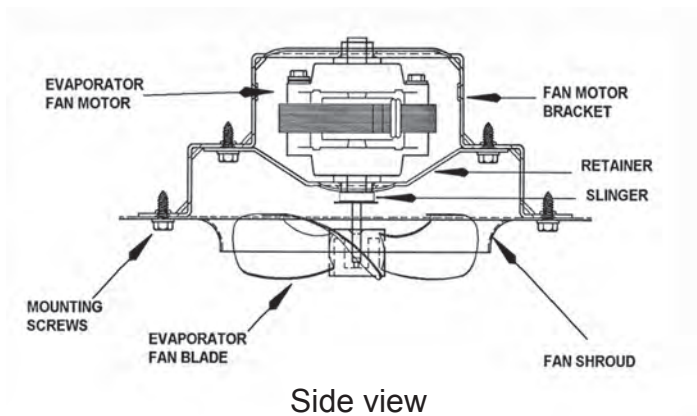

# Evaporator Component Identification, Access and Troubleshooting (continued)

## Removing the evaporator fan motor with shroud

### **! WARNING**



#### **Electrical Shock Hazard**

**Disconnect power before servicing.**

**Replace all parts and panels before operating.**

**Failure to do so can result in death or electrical shock.**

1. Disconnect the power to the refrigerator.

2. Remove the evaporator cover as described previously.

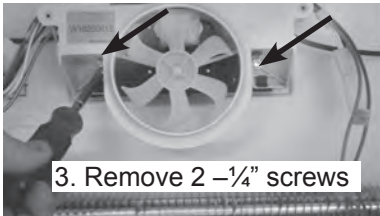

3. Remove 2 -1/4" screws

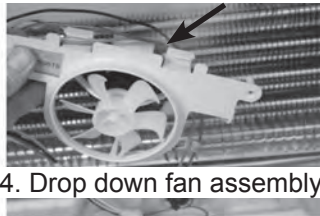

4. Drop down fan assembly



5. Remove harness from bracket

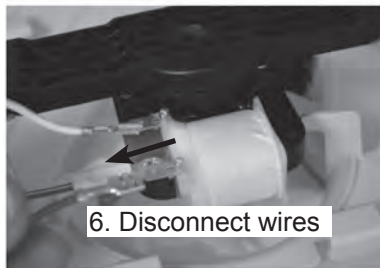

6. Disconnect wires

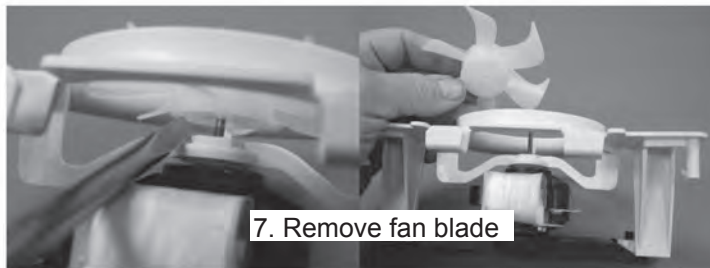

7. Remove fan blade



8. Release left and right side locking tabs

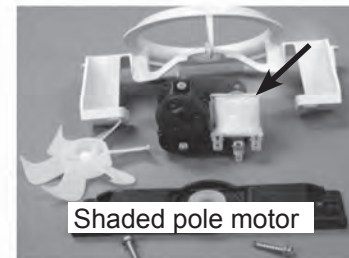
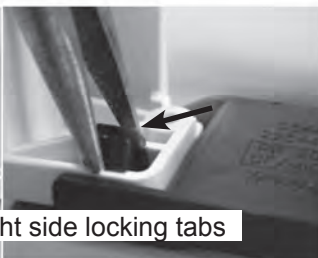

Shaded pole motor

**NOTE:** When assembling, press the fan blade on the motor shaft until the blade bottoms out on the shaft.

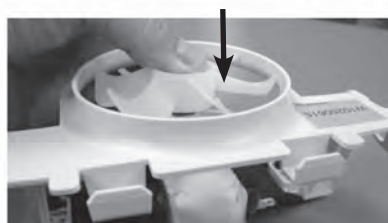

# Evaporator Component Identification, Access and Troubleshooting (continued)

## Removing the evaporator fan motor (continued) Open design (no shroud)

1. Disconnect the power to the refrigerator.
2. Remove the evaporator cover as described previously.

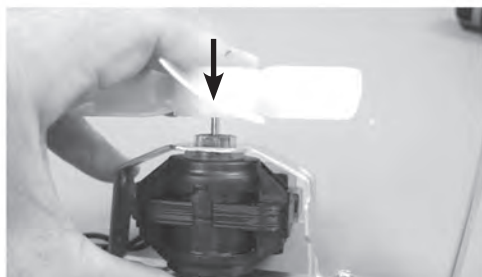
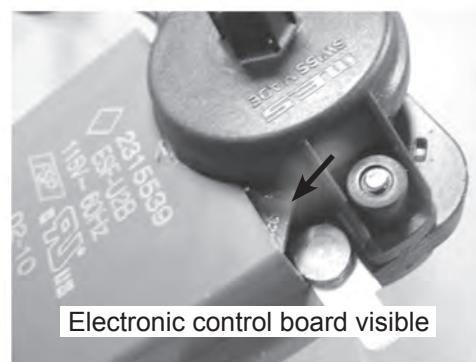
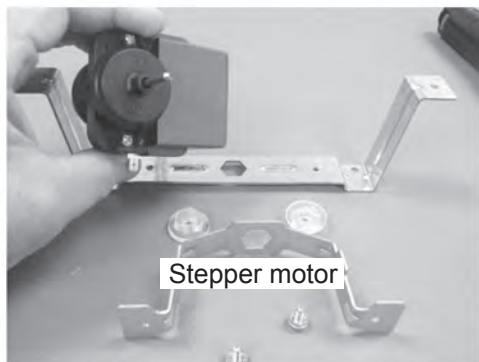
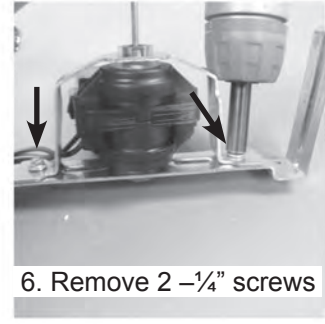
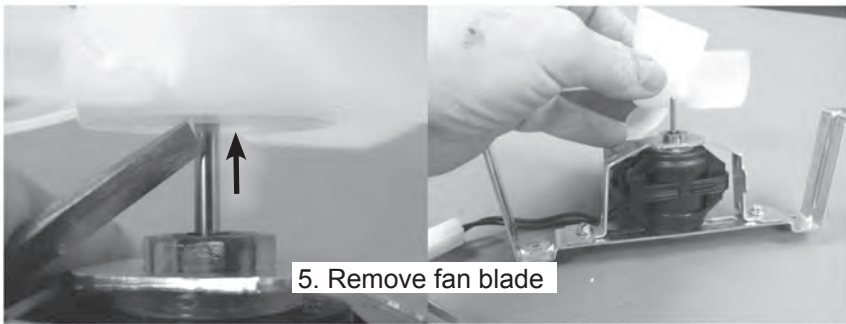
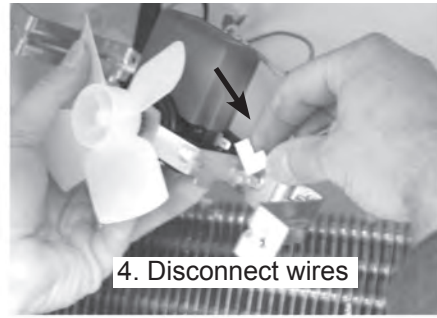
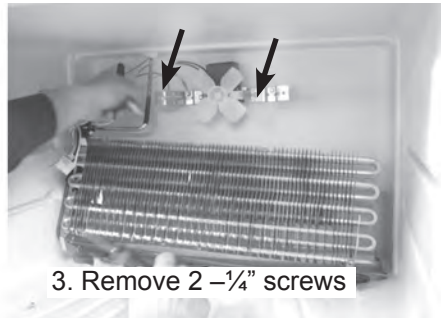

**NOTE:** When assembling, press the fan blade on the motor shaft until the blade contacts the shoulder on the shaft, see figure 1.

# Evaporator Component Identification, Access and Troubleshooting (continued)

## Checking Evaporator Shaded Pole Fan Motors

### **! WARNING**



#### **Electrical Shock Hazard**

**Disconnect power before servicing.**

**Replace all parts and panels before operating.**

**Failure to do so can result in death or electrical shock.**

1. Disconnect power to the refrigerator  
Remove the evaporator cover as explained previously.

**NOTE:** The motor does not have to be removed from its installed position to check. See figure 1.

2. Disconnect the wires to the fan motor.  
Connect the meter leads across the motor. The meter reading should fall within the known range of the type of motor you are checking.

Example: See figure 1 and 2. If the meter measures infinity, the motor winding is open and the motor must be replaced. Common motor failures requiring replacement:

- Noisy
- Lack of lubrication
- Open winding

**NOTE:** Do not attempt to make a resistance check on a stepper motor.

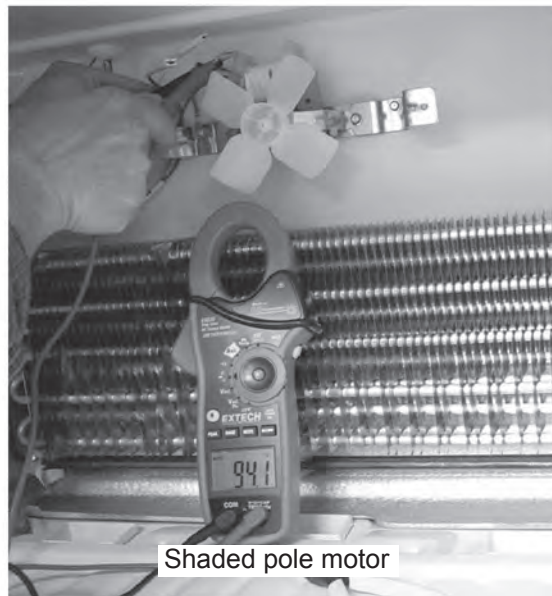

Shaded pole motor

Figure 1.

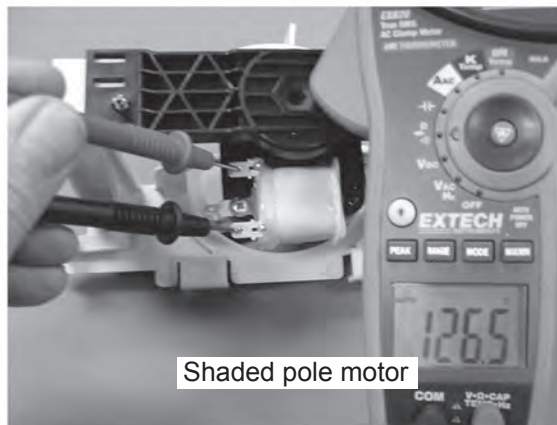

Shaded pole motor

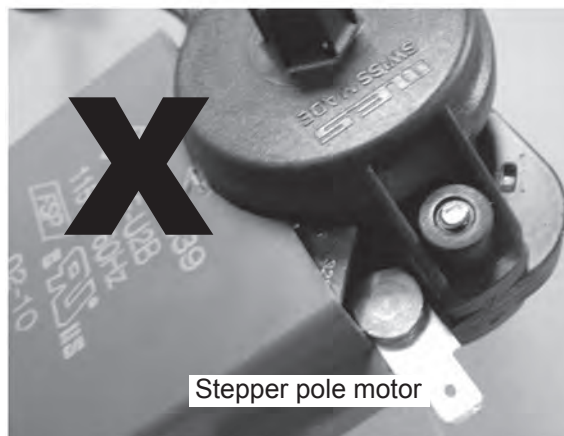

Stepper pole motor

# MACHINE COMPARTMENT COMPONENT IDENTIFICATION, ACCESS AND TROUBLESHOOTING

## Static condenser

A static condenser is a tube-type condenser mounted to the rear of the cabinet. A large flat condenser coil is mounted to the rear of the cabinet with space provided between the cabinet back and the coil. This arrangement requires the flow of air up the back of the cabinet. The air flows around all of the tubes of the condenser. Advantages of this system are the removal of the condenser from the cabinet interior and the elimination of the condenser fan to force air over the coil. A disadvantage is the poor shielding for the condenser coil itself.

With a static condenser, the process of dispersing heat from the refrigerant becomes less effective as the ambient temperature increases. A system that may perform well in conditions between 70 and 80 degrees will require significantly longer run times at temperatures nearing 100 degrees. The systems are also less tolerant of reduced airflow at higher ambient temperatures.

Since most condensers are mounted in the bottom rear of the cabinet, the installation instructions must be followed to allow for proper airflow.

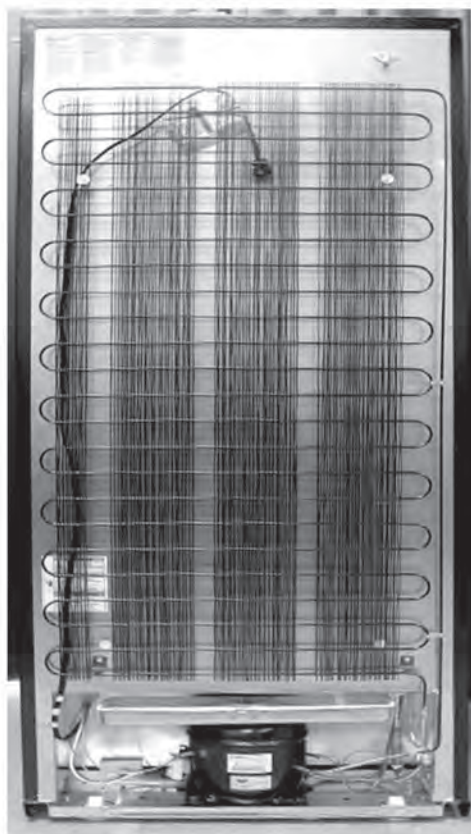

## Forced Air Condenser

In a fan-forced condenser system a fan is used to draw ambient air through the condenser. The airflow can be used to cool the refrigerant as well as provide a cooling airflow for the compressor. With a forced-air design, the condenser can be folded into a more compact design. With a compact condenser the entire high side of the sealed system can be fit into a machine compartment .



# Machine Compartment Component Identification, Access and Troubleshooting (continued)

Most forced systems have both the inlet and outlet of the condenser air on the front of the cabinet. This is often referred to as a two pass system. A major advantage of having both the air inlet and outlet on the front of the refrigerator is the ability to build the system into the surrounding cabinets.

## Heat loop Routing (Example)

The heat loop is routed from the condenser outlet up the right side of the cabinet to the right stile (A).

It then loops through the mullion between the refrigerator and freezer sections (B) and up around the freezer section (C & D).

It then returns to component compartment (E) and connects to the filter-drier.

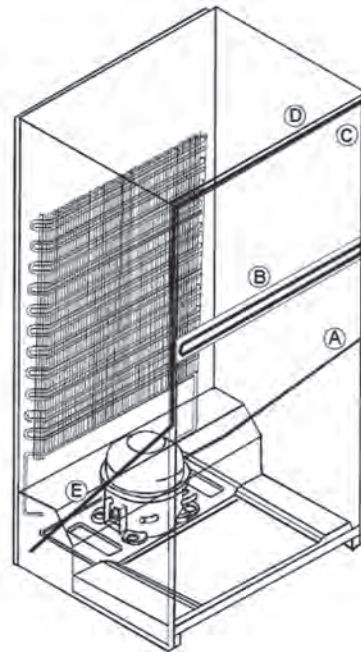

## Heat Loop Routing (Example)

1. The heat loop enters the cabinet through a grommet at the bottom and bends to the side.
2. It then angles up to the front of the cabinet.
3. At the separator between the refrigerator and freezer compartments, the loop turns and travels across the mullion.
4. Then up the right stile.
5. Across the top mullion.
6. Down the left stile.
7. The loop then angles back toward the left rear corner of the cabinet.
8. Then returns to the refrigerator compartment through a grommet.

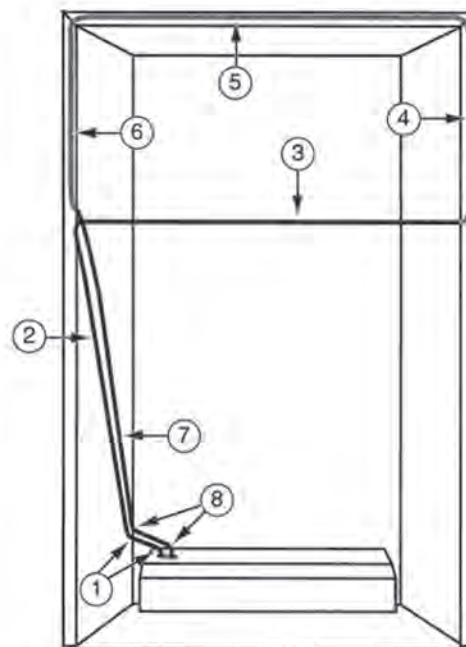



# Machine Compartment Component Identification, Access and Troubleshooting (continued)

## Accessing refrigerator compartment component.

Forced air condenser refrigerators utilize a compartment cover to direct air across the condenser and compressor (Static condenser refrigerators do not require compartment covers).

To Remove:

<b>⚠ WARNING</b>

<b>Electrical Shock Hazard</b> <b>Disconnect power before servicing.</b> <b>Replace all parts and panels before operating.</b> <b>Failure to do so can result in death or electrical shock.</b>

1. Disconnect power to the refrigerator
2. Remove the cover screws and remove the cover, see figures 1 and 2.

**NOTE:** Cover must be reinstalled to avoid overheating of compressor and condenser.



Figure 1

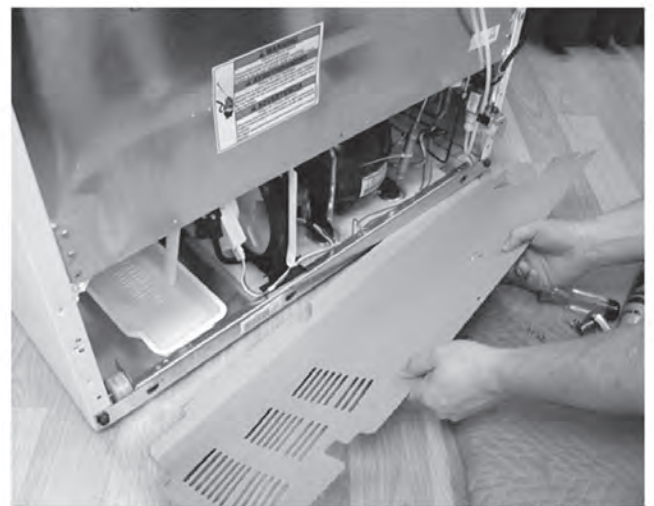
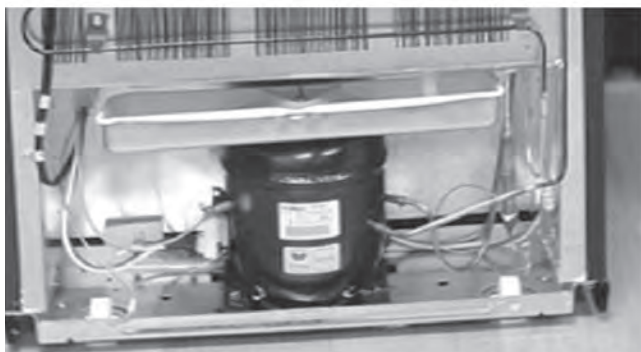
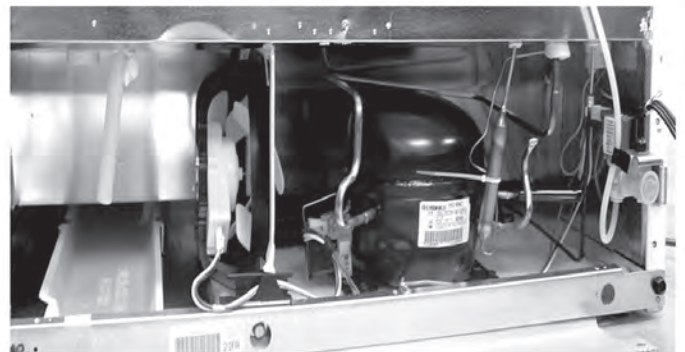

Figure 2



Static condenser



Forced air condenser

# Machine Compartment Component Identification, Access and Troubleshooting (continued)

## Compressors

Reciprocating or piston type compressors are currently being used on all production refrigerators. The compressor is a motor driven pump that pulls refrigerant vapor out of the evaporator and pushes it into the condenser. A cam drives a piston backwards and forward in a cylinder. At the opposite end of the cylinder, two valves open and close to allow refrigerant to be pulled into and expelled from the cylinder.

On the intake stroke, the movement of the piston closes the exhaust valve and opens the suction valve. This allows refrigerant vapor to be pulled into the chamber. On the exhaust stroke, the piston forces the suction valve closed and pushes the exhaust valve open to allow the refrigerant vapor to be pushed into the condensing coil.

Whirlpool compressors are manufactured by Embraco and Panasonic.

The Embraco compressors are either full size or a smaller version commonly referred to as the Mini-Embraco.



Embraco mini compressor

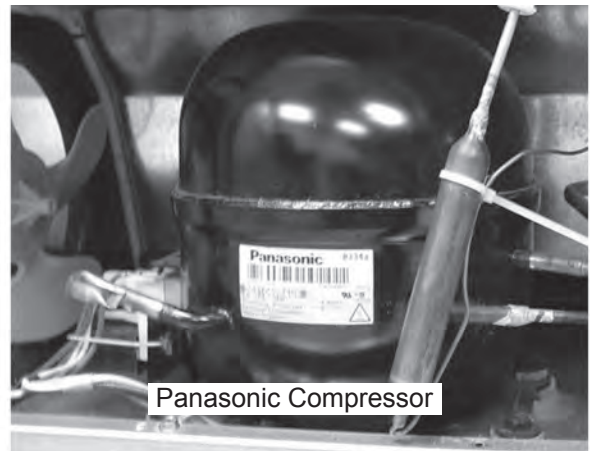

Panasonic Compressor

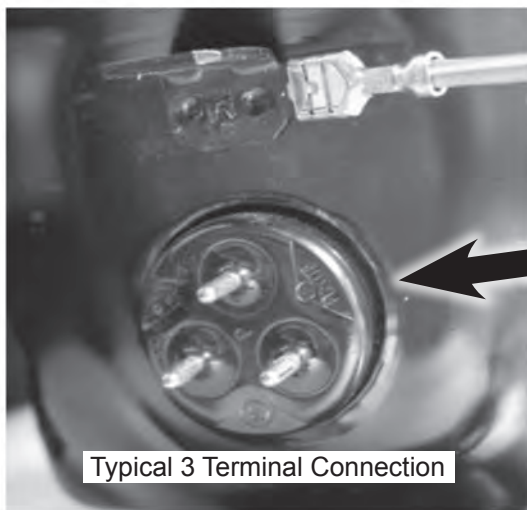

Typical 3 Terminal Connection

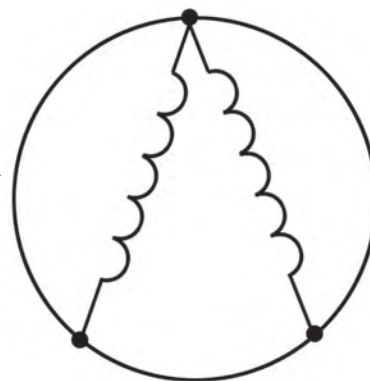

Motor Schematic Symbol

# Machine Compartment Component Identification, Access and Troubleshooting (continued)

## Types Of Compressor Motors

### Split Phase Compressor Motors

Several types of compressors are presently in use. While they vary in physical appearance they're all very similar electrically. Split phase motors are used to drive older design-refrigerator compressors. A starting device, such as a relay or solid state device (P.T.C.) is used to engage the start winding of the motor. Some older designs incorporated a start capacitor to give the start winding additional torque.

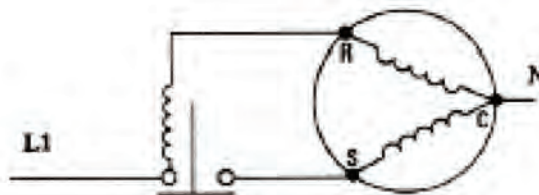

Split phase motor design

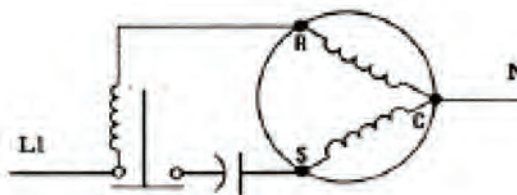

Older split phase motor design with start capacitor

### Permanent Split Phase Compressor Motors

For energy efficiency and conservation, most compressors manufactured today use permanent split capacitor motors. These especially constructed motors may run without the capacitor but won't operate as efficiently. The capacitor is wired between the start and run windings and is bypassed during compressor start. Once the motor attains running speed and the relay has removed the start winding from the circuit, the capacitor limits the current draw of the motor thus reducing overall energy usage.

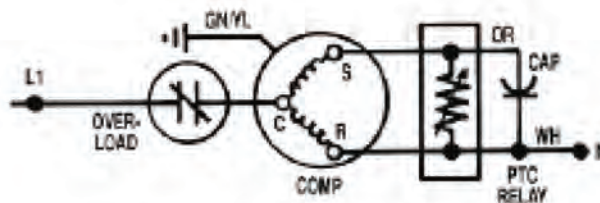

Permanent split capacitor motor design

# Machine Compartment Component Identification, Access and Troubleshooting (continued)

## Identifying Compressor Windings

**! DANGER**



### Electrical Shock Hazard

**Only authorized technicians should perform diagnostic voltage measurements. After performing voltage measurements, disconnect power before servicing. Failure to follow these instructions can result in death or electrical shock.**



Measuring compressor motor resistance

### Split Phase Motors

Checking the compressor motor begins with the proper identification of the motor terminals. After disconnecting the compressor wires, check the resistance between all three terminals. Since both the start and run windings are connected internally, finding the two terminals that give the highest resistance reading isolates the common terminal. Because the windings are in series (as read by the meter), the highest reading indicates that you have located the S (start) and R (run) terminals. See figure . With the meter still attached to these two terminals, the remaining terminal must be the C (common) terminal. Once the common terminal has been isolated, the start and run windings can then be identified.

By placing one of the meter leads on the common terminal, measure the resistance of the other two terminals. The lowest reading of the two will identify the run winding. The remaining terminal must, therefore, be the start winding. After all the terminals are identified, a resistance reading from each of the three terminals to ground should be taken to insure that the compressor isn't shorted internally. The meter should remain on infinity.

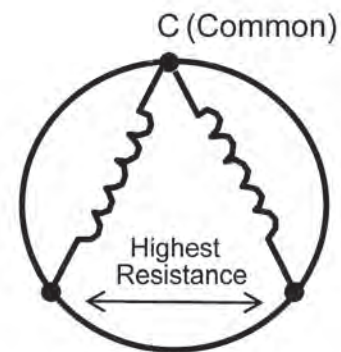

Schematic symbol

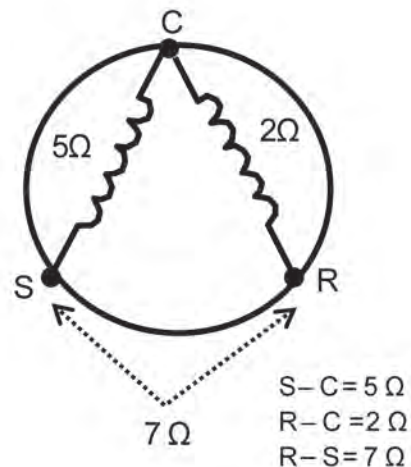

Resistance Checking

# Machine Compartment Component Identification, Access and Troubleshooting (continued)

## Inverter Control

Compressor harness connector

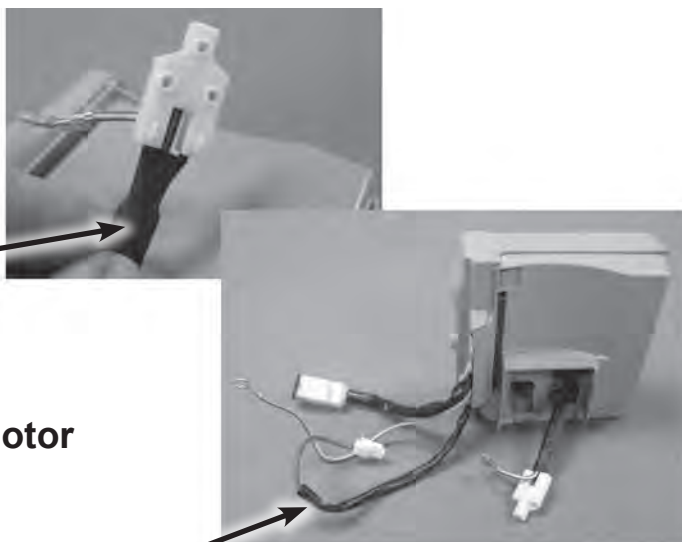

## Used With 3 Phase Compressor Motor

Inverter

Energy efficient refrigerators are sometimes equipped with variable capacity compressors. The number of windings and the frequency of the power applied to the windings control the speed of a compressor motor. If a control system is placed between the incoming power and the compressor that is capable of changing the frequency of the power applied, the speed of the motor can be controlled. At different speeds, the sealed system can more closely match the required cooling load under different conditions.

The control circuitry has two functions, determine the proper speed for the compressor and develop drive voltages that will provide that speed. In most variable capacity compressor configurations, the compressor motor is actually a three-phase motor design.

The incoming 120 VAC power is converted to a DC supply. This voltage supply could provide between 150 and 300VDC depending on design. This high voltage DC can then be switched to provide output for the windings of the compressor motor.

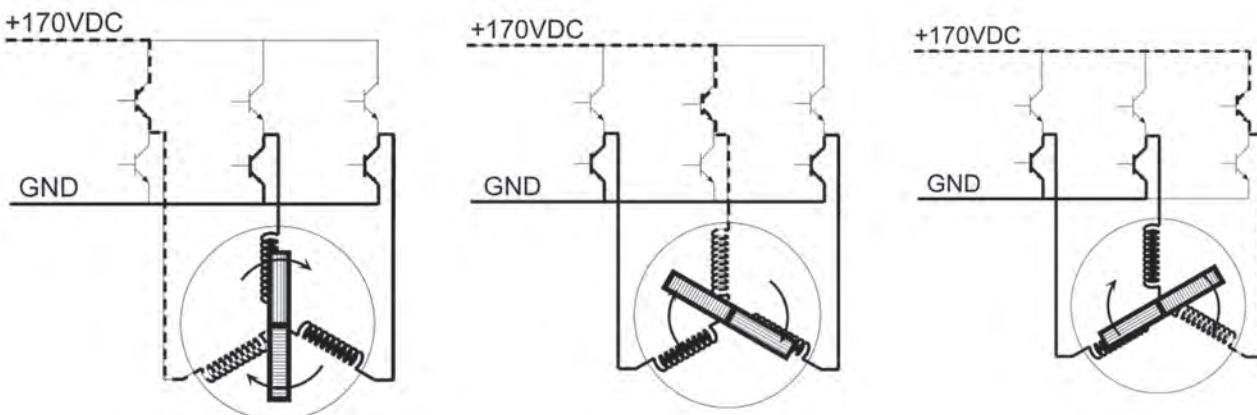

The frequency of the drive voltages will determine the speed of the compressor. The motor is almost always started at high speed to allow sufficient torque to get the system started. Once the compressor is turning, the frequency can be decreased to match the speed calculated by the control circuit.

# Machine Compartment Component Identification, Access and Troubleshooting (continued)

## Bimetal Overloads

Overloads are designed to react to excess current and temperatures. Mounted against the side of the compressor and in series with the run winding, the overload will open the compressor circuit if current draw or temperature exceed design parameters.

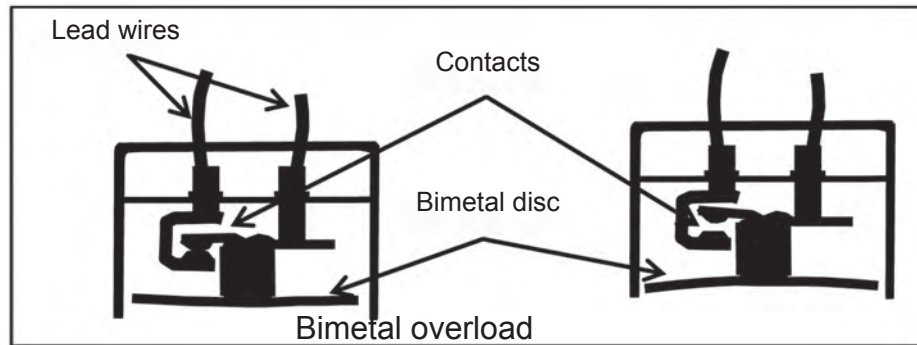

Overload avoidance can take two forms. The primary form of avoidance is based on current draw. All current for the compressor circuit passes through an overload. If current becomes excessive, the overload opens and power is interrupted. A second form of compressor overload is temperature based. The temperature of the compressor case is monitored. If the case temperature is excessive, the overload protector will open the circuit. Both current and temperature avoidance can be included in the start device package. This can be the case with PTC type start controllers. A resistance check can be made to determine if the overload contact is open or closed. Measure the resistance across the contact. If a high resistance or infinity is measured the contact is open and must be replaced.

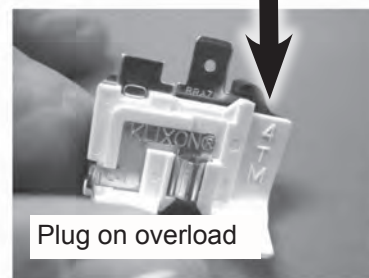
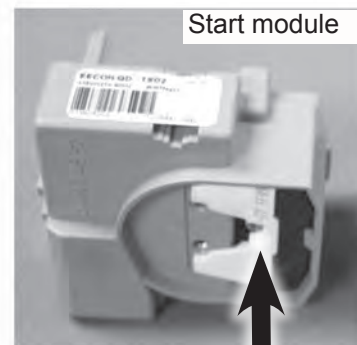

An 'OL' reading on the meter used in this example indicates a reading "out of limits". This usually means an open circuit.



# Machine Compartment Component Identification, Access and Troubleshooting (continued)

The P.T.C. Thermistor (Positive Temperature Co-efficient Thermistor or Solid State Relay) is the most widely used compressor-starting device. A PTC relay is a solid-state device that will perform the same function as a magnetic relay. Power is applied to the relay and passed through the module directly to the run winding of the compressor. Power for the start winding passes through a solid state material. This material changes resistance depending on its temperature. At room temperature the resistance is very low and full power is applied to the start winding. As current passes through the resistance on the way to the start winding, the resistor heats up. As the temperature increases, the resistance increases. With an increased resistance, less current is applied to the start winding. Eventually the current to the start winding nears zero and the start winding will be turned off. This entire process takes about a second.



PTC Plug On Relay

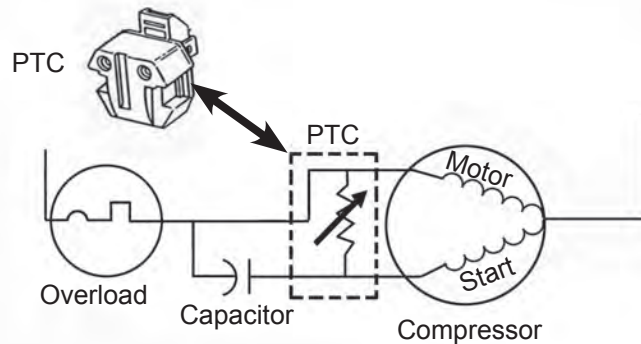

Example: When cold, the thermistor has a resistance of about 5 Ohms. As current passes through the Thermistor, heat is generated and the resistance rises rapidly. Within 1 to 3 seconds, the internal resistance of the P.T.C. goes from 5 Ohms to 100 K Ohms or more. The rise in resistance effectively takes the start winding out of the circuit.

NOTE: Thermistors get very hot.

A PTC device needs to cool before it can cycle again. Cooling to room temperature can sometimes take as long as ten minutes. For this reason, during service, cycling a PTC controlled compressor quickly will result in the motor trying to start on the run winding only. Without the start winding energized, the compressor will not start, draw excessive current and de-energize based on the overload.

# Machine Compartment Component Identification, Access and Troubleshooting (continued)

## Start Module

The start module combines three separate starting components; run capacitor, PTC relay and overload. Although these components can sometimes be separated into individual pieces, it's always advisable to replace the assembly.

The run capacitor can usually be removed from the assembly for replacement. To check a run capacitor requires the use of a capacitor analyzer or analog VOM. Refer to the instructions shipped with the test equipment describing how to check a capacitor. Normally if the run capacitor is in question, it is replaced. The voltage and MFD rating of the capacitor is printed on the side

## Removing Start Module

<b>⚠ WARNING</b>

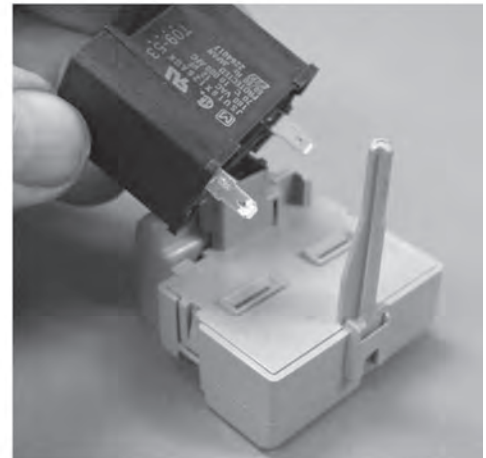
<b>Electrical Shock Hazard</b> <b>Disconnect power before servicing.</b> <b>Replace all parts and panels before operating.</b> <b>Failure to do so can result in death or electrical shock.</b>



Run capacitor plugs into module

1. Disconnect power to the refrigerator
2. Remove the machine compartment cover as previously described
3. Remove the bail arm
4. Disconnect electrical connector
5. Unplug start module

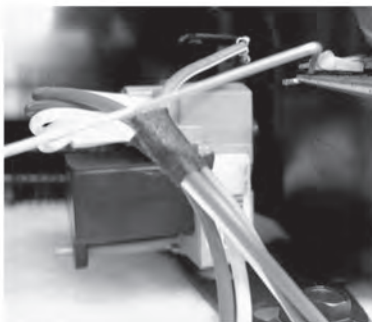
**NOTE:** the module terminals fit tightly on the compressor and may be difficult to remove



Remove bail arm



Disconnect wire harness

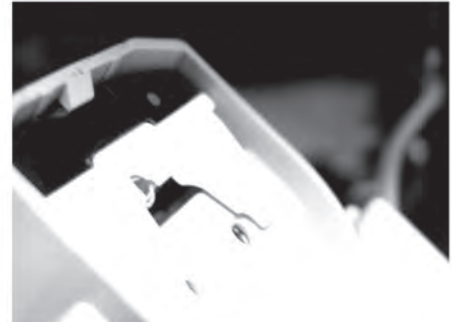

Unplug start module



# Machine Compartment Component Identification, Access and Troubleshooting (continued)

## Starting Relays

The most common compressor motor starting relay used with older refrigerators is the current magnetic relay. It is also referred to as an amperage relay. The relay operates based on the increase in current at the instant of motor start.



Current magnetic relay

L and S contacts are normally open, the magnetic relay coil is wired between L and M and in series with the run winding. When the compressor circuit is energized the significant amount of starting current will pull the relay contacts L to S closed and provide power through the coil for the run winding and power through the closed relay contacts for the start winding. Once the motor nears operating speed, the current will dramatically decrease through the run winding

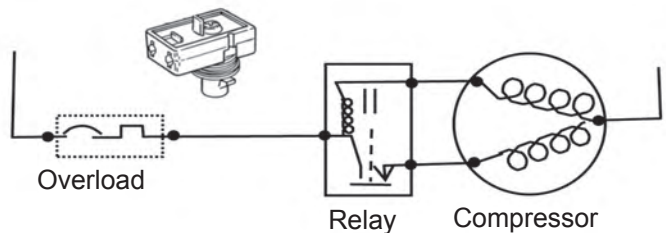

Typical Mechanical Relay Schematic

As the run winding current decreases, the current through the coil of the relay decreases; with less current flowing in the relay coil, the magnetic field will decrease and relay contacts L to S will open. When the relay contacts open, the current through the contacts is interrupted and power is removed from the start winding.



Terminal Identification  
L - Line R- Run S- Start

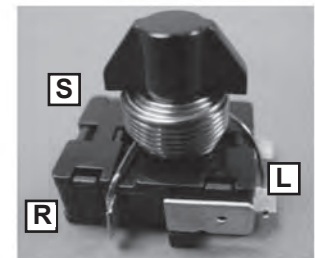

Relay coil wired between L and R



When checking with an OHM meter contacts L to S should be open with the relay in the normal operating position.



The contacts should close when the relay is turned over.

# Machine Compartment Component Identification, Access and Troubleshooting (continued)

## Removing the Condenser Fan

**⚠ WARNING**



**Electrical Shock Hazard**  
**Disconnect power before servicing.**  
**Replace all parts and panels before operating.**  
**Failure to do so can result in death or electrical shock.**

1. Disconnect power to the refrigerator.
2. Remove machine compartment cover as previously described.

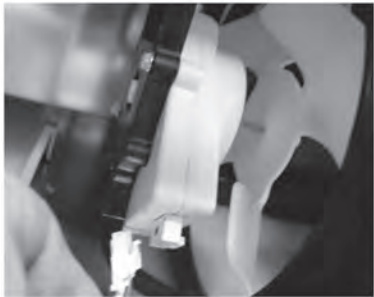

Disconnect wires



Remove 2  $\frac{1}{4}$ " screws



Remove motor

## Stepper Fan Motor

As a reminder, a stepper motor can be identified by spinning the fan blade. If the blade comes to a gradual “jerky” stop it indicates a stepper design if the blade continues to rotate freely it indicates a shaded pole design. A conventional resistance check cannot be used to check a stepper motor. Checking across the leads of a stepper motor would indicate an open circuit even if the stepper motor was functional. If 120 VAC is applied to the motor and it is not running, replace it.

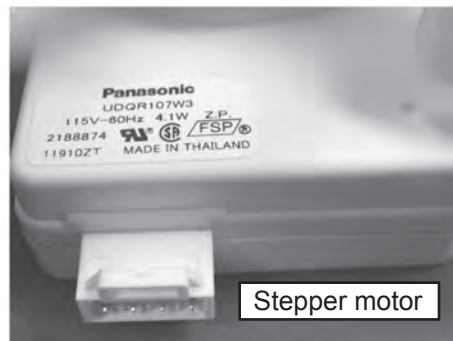

# Machine Compartment Component Identification, Access and Troubleshooting (continued)

## Removing the Condenser Fan Motor-cont

Jelly roll condenser design  
To remove:

**NOTE:** When installing the fan blade, leave the same length of motor shaft exposed as noted during removal. Failure to do so can result in reduced air flow over the condenser, see step 3.

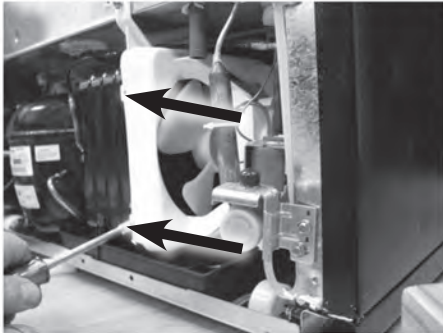

1. Remove 2-1/4" screws



2. Disconnect wire harness

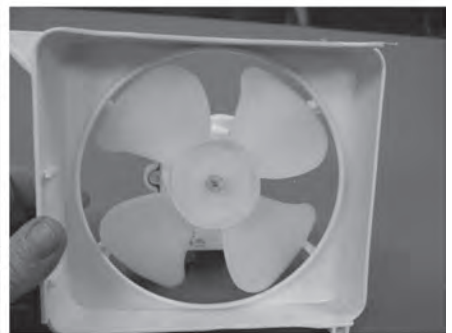

3. Remove fan motor assembly

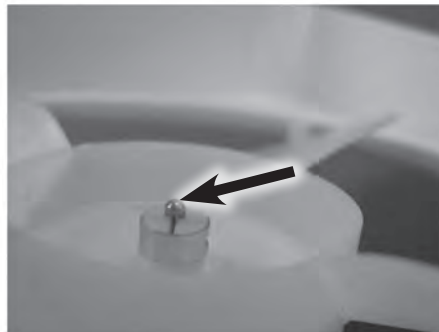

Notate the position of the fan blade on the shaft



4. Remove fan blade

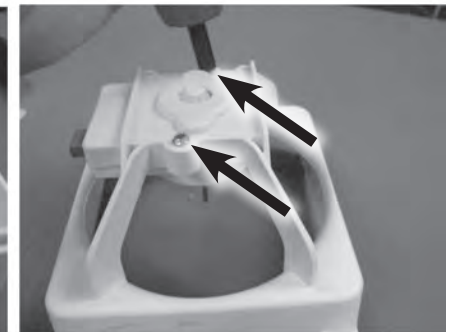

5. Remove 2 -1/4" screws



6. Remove fan motor



7. Remove fan motor assembly

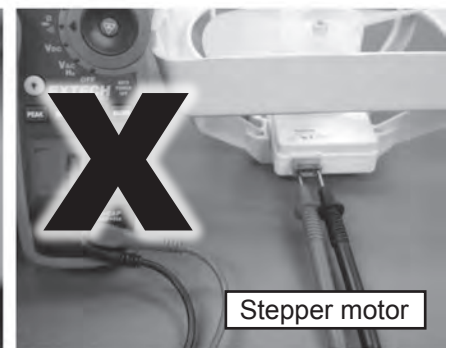

**NOTE:** The condenser fan motor cannot be checked with an Ohmmeter"

# Machine Compartment Component Identification, Access and Troubleshooting (continued)

## Condenser Fan Motor-cont.

Another design condenser fan motor is an encased shaded pole version. This motor can be removed as previously described. Note: The position of the fan blade should be noted so it can be reassembled correctly.

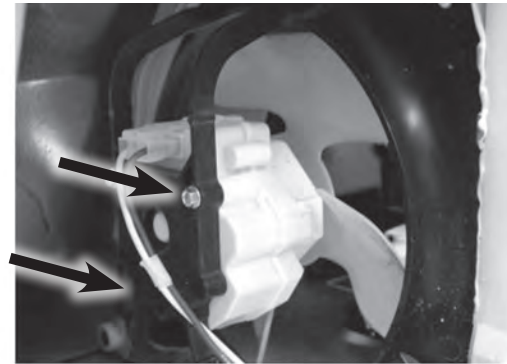

Disconnect wire harness and remove 2 screws securing the motor to the bracket



Remove fan assembly

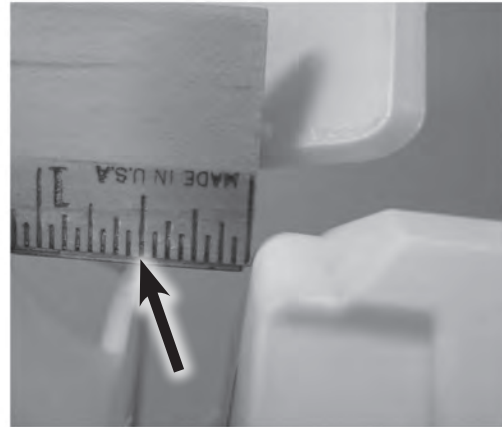

Notate the position of the fan blade on the motor shaft



Figure 1

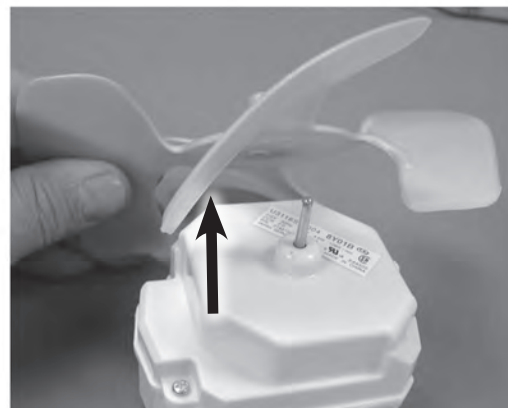

Blade slides off the motor shaft

## Checking shaded pole motor:

Connect an Ohmmeter across the motor terminals . Compare the reading with the known value of a similar motor or check the tech s Note: When installing the fan blade, leave the same length of motor shaft exposed as noted during removal. Failure to do so can result in reduced air flow over the condenser. heat for the specification. The resistance of the motor in figure 1 is approximately 700 Ohms. An infinite or OL (out of limit) reading indicates an open motor coil.

# Machine Compartment Component Identification, Access and Troubleshooting (continued)

## Evaporation Pans

Evaporator defrost water is routed to an evaporation pan in the machine compartment. There are 2 different designs. On a static condenser model, the evaporation pan usually is mounted on top of the compressor and relies on heat from the compressor to assist in evaporation, see figures 1 and 2.

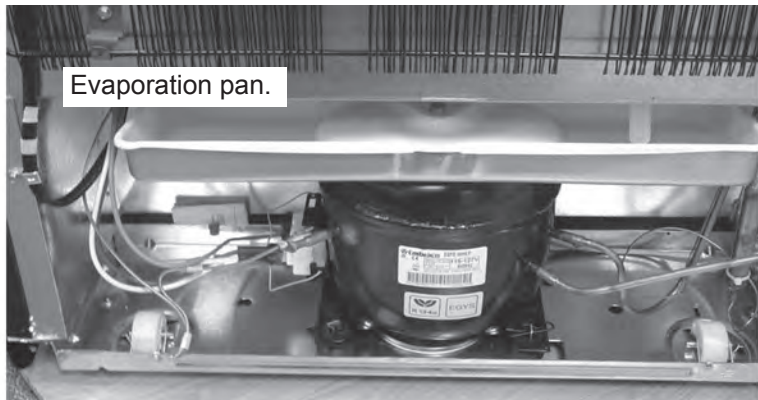

Figure 1

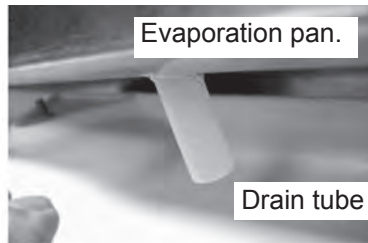

Figure 2



Figure 3



Figure 4

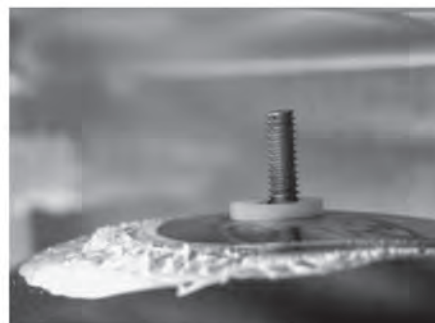

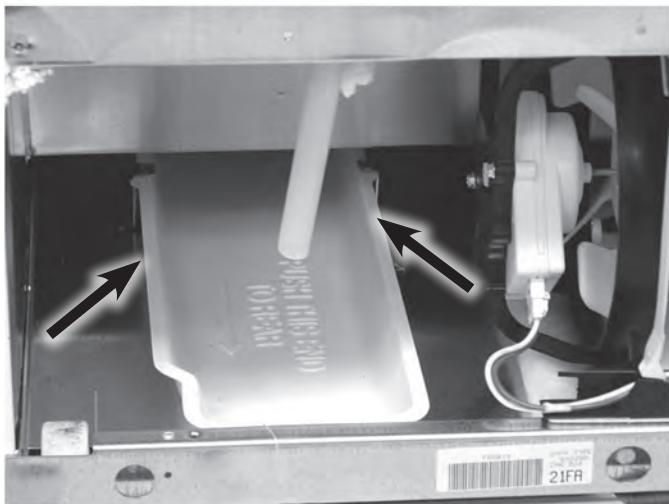

Figure 5

## Machine Compartment Component Identification, Access and Troubleshooting (continued)

<b>⚠ WARNING</b>

<b>Electrical Shock Hazard</b> <b>Disconnect power before servicing.</b> <b>Replace all parts and panels before operating.</b> <b>Failure to do so can result in death or electrical shock.</b>

A bolt welded on the top of the compressor is used to secure the pan . Remove the ½ “ bolt and lift off the pan to remove, see figures 3 and 4. The white substance under the pan is a thermal bond substance to assist in heat transfer, see figure 5.



Forced air condenser designs use an evaporation pan that is placed directly in the air flow .The pan is held in place with metal tabs. Bend the metal tabs outward to remove the pan, see figure 6.

**NOTE:** In certain ambient conditions, a build up of debris in the pan can result in a noticeable odor. The pan can be cleaned or replaced as necessary.

Forced air evaporation design

Figure 6

# Machine Compartment Component Identification, Access and Troubleshooting (continued)

## Accessing and removing rollers

### **!WARNING**



#### Tip Over Hazard

Refrigerator is top heavy and tips easily when not completely installed. Keep doors taped closed until refrigerator is completely installed. Use two or more people to move and install refrigerator. Failure to do so can result in death or serious injury.

### **!WARNING**

**Excessive Weight Hazard**  
Use two or more people to move and install refrigerator. Failure to do so can result in back or other injury.

#### Front Roller with Leveling Legs

The front leveling legs screw into the front roller bracket. The leveling leg can be screwed completely out to replace. The front roller is part of an assembly. 2 ¼" screws secure the roller bracket to the bottom of the cabinet. Remove the screws and change the assembly.



Leveling leg



1. Locate screws



2. Remove 2 ¼" screws



3. Remove assembly

#### Fixed Rear Rollers

The rear rollers are not adjustable. If the rear of the refrigerator needs to be leveled shims must be used. The rollers and axles are secured into a formed bracket that is part of the base. A metal tab is folded up against the axle to lock it into place.



1. Fold the locking tab down to allow the axle to be removed from the roller and bracket.



2. Remove axle



3. Remove roller

# Machine Compartment Component Identification, Access and Troubleshooting (continued)

## Accessing and removing rollers - cont.

### Adjustable front rollers fixed rear roller version

To Remove wheels :

1. Disconnect power to the refrigerator.



Adjustable front rollers  
fixed rear roller version



2. Remove grille



3. Remove 1/2" bolts on left  
and right hand sides  
Remove grille



4. Remove 3/8" bolts on  
left and right hand sides.



5. Remove machine compartment screws and remove cover



6. Remove 1/2" bolts on left  
and right hand sides.



7. Slide the base backward 2-3"





## Machine Compartment Component Identification, Access and Troubleshooting (continued)



To change a rear roller remove the axle and lift out the roller.



To change a front roller,  
1. Lift the front of the cabinet high enough to access the axle.

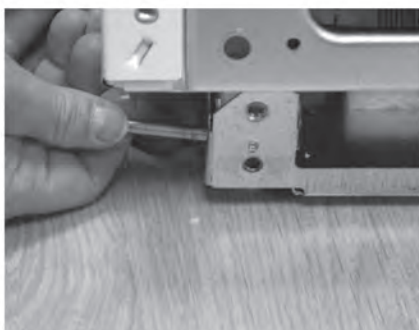

2. Remove axle to free roller.



3. Remove roller

# ICE MAKER COMPONENTS ACCESS AND TROUBLESHOOTING

## Removing the ice maker

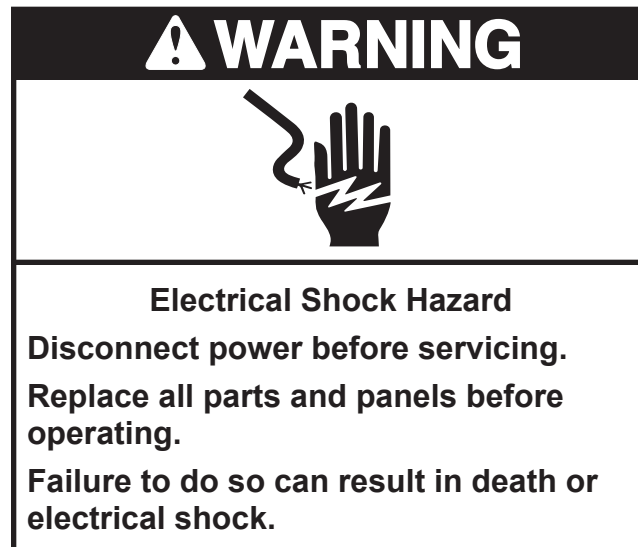

1. Unplug refrigerator or disconnect power.

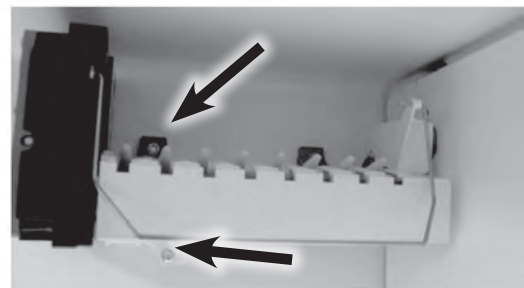

Figure 1

2. Loosen the 2 - 1/4" screws and remove the lower screw, see figure 1.

3. Lift the ice maker up and then twist the ice maker counter clockwise to disengage the two screws through the slots in the ice maker mold, see figure 2.

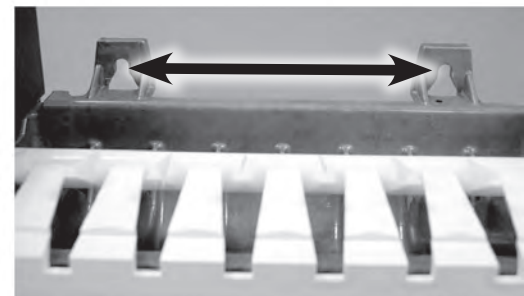

Figure 2

4. Drop the ice maker down and unplug the wire harness, see figure 3.

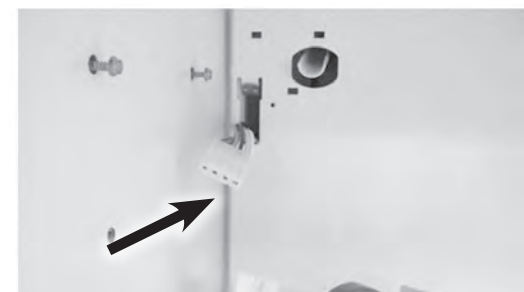

Figure 3

# Ice Maker Components Access and Troubleshooting (continued)

## Ice maker thermal fuse

A thermal fuse is imbedded in the ice maker wiring harness. The purpose of this fuse is open the circuit to the ice maker in case of a malfunction that would cause the mold heater to remain energized. See figure 1.

If the thermal fuse is open the ice maker will not function.

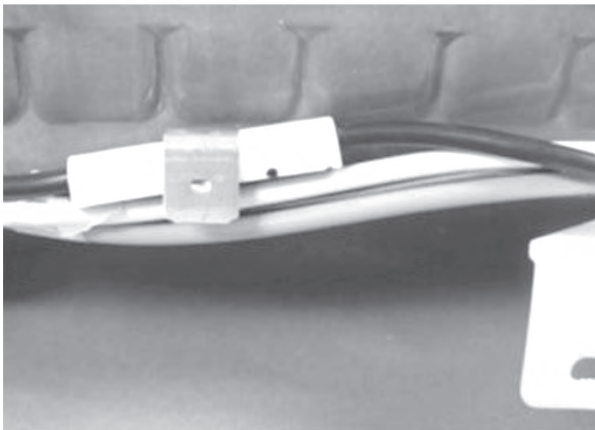

Figure 1

To remove the harness. With the ice maker removed and unplugged from the refrigerator, depress the locking tab securing the wire harness to the ice maker housing. See figure 2.

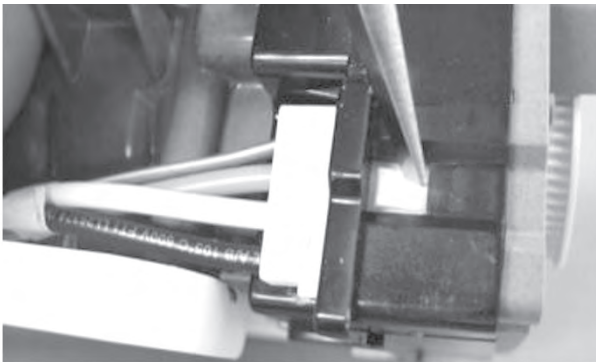

Figure 2

Disconnect wire harness, see figure 3.

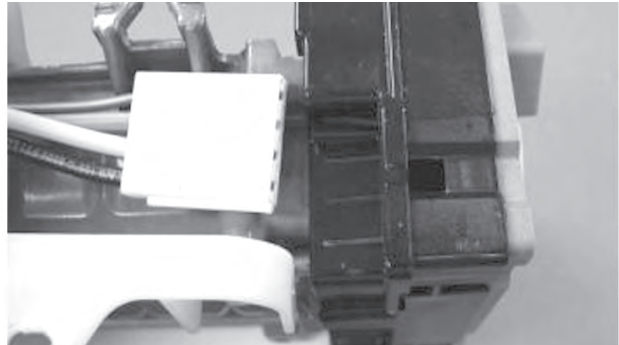

Figure 3



Figure 4

Checking Thermal fuse:

To check the thermal fuse remove the wire harness. Connect an Ohmmeter across the thermal fuse, normally the black wire. There should be zero Ohms resistance measured indicating a closed thermal fuse.

See figure 4. An infinite or OL (out of limit) reading indicates an open thermal fuse.

Note: If the thermal fuse is open, check the operation of the ice maker mold heater after replacing the fuse.

# Ice Maker Components Access and Troubleshooting (continued)

## Water inlet valve

The water inlet valve uses a solenoid coil to lift a small plunger off a bleed hole in the diaphragm. This action allows water to drain from the top side of the diaphragm. The effect of this is to reduce the pressure on the top of the diaphragm. Water pressure on the bottom side of the diaphragm pushes the diaphragm up opening the inlet orifice, allowing water to enter the machine. A flow washer in the valve maintains a constant flow rate over a range of supply water pressures. De-energizing the solenoid coil allows the plunger to drop and shut off the bleed hole. Water now seeps through a very small hole in the diaphragm; as a result water pressure builds up on the top side of the diaphragm. This increased pressure pushes the diaphragm down to cover the inlet orifice and shut off the water flow. Water valves operate on 120 VAC. The operating water pressure range is 30 PSI to 120 PSI. Pressures above or below this range can cause the valve to malfunction.

**NOTE :** Avoid disassembling a water valve, failure to assemble correctly may lead to failure and property damage.

## Checking water valve

**⚠ WARNING**



**Electrical Shock Hazard**

**Disconnect power before servicing.**

**Replace all parts and panels before operating.**

**Failure to do so can result in death or electrical shock.**

2. Remove the machine compartment cover as explained previously.
3. Disconnect the wiring harness, see figures 1 and 2.
4. Connect the meter leads across the water valve terminals, see figure 3.
5. Compare the meter reading with the known value of a good valve or refer to the tech sheet for the correct specification.  
If the meter reads infinity, it indicates the valve is open and needs to be replaced.

1. Disconnect power to the refrigerator.



Remove 2  $\frac{1}{4}$ " screws.

Figure 1



Remove valve and disconnect wire harness.

Figure 2



Connect meter leads across the valve terminals.

Figure 3

**—NOTES—**

# WIRING DIAGRAMS

## Example: Model W8TXNWMWQ Schematic

18 cu. Ft. Top Mount Refrigerator Static Condenser  
 Forced Air Evaporator  
 Adaptive Defrost Control  
 Optional Ice Maker Kit Available

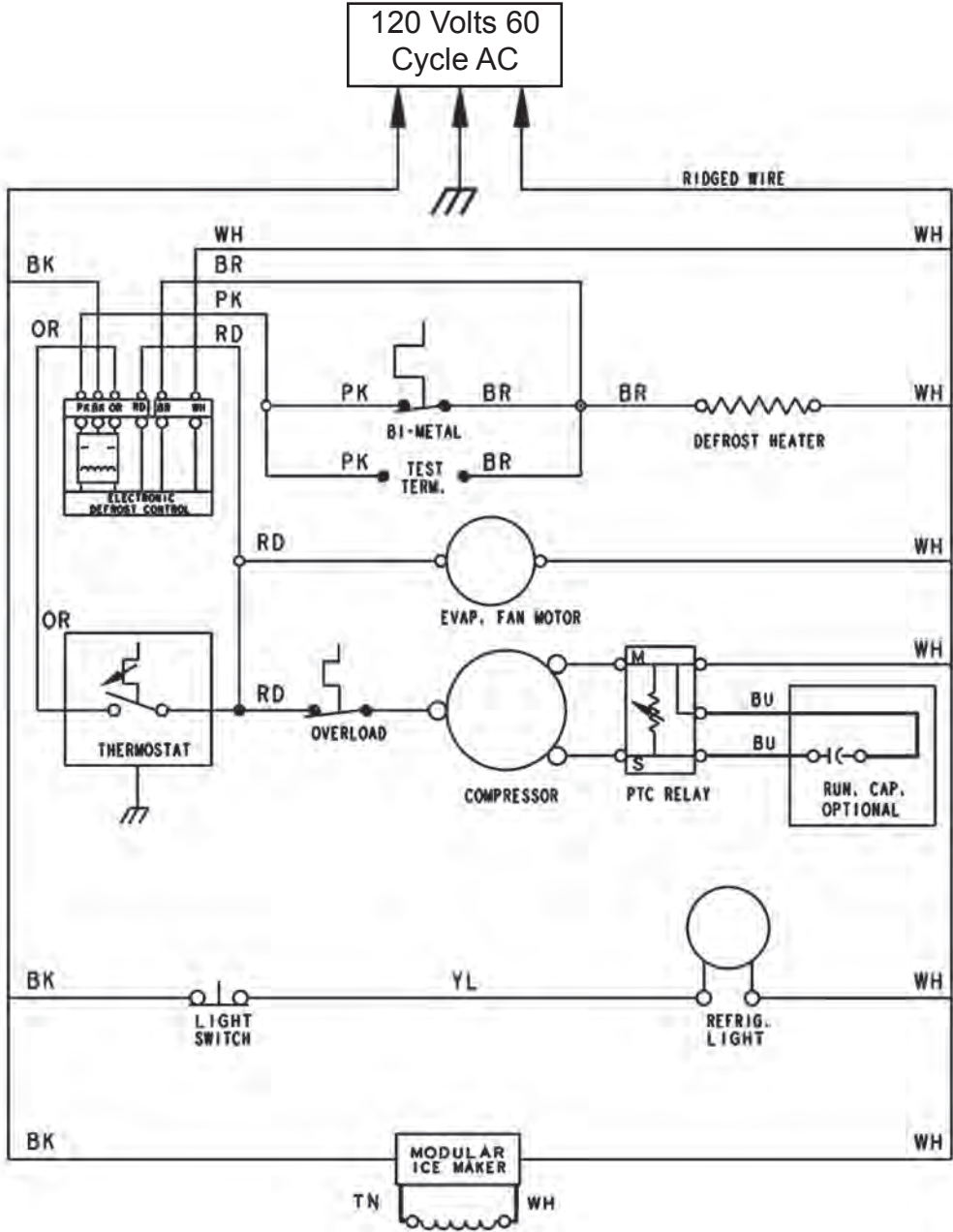

Water Valve Optional On Ice Maker Kit Models

# Wiring Diagrams (continued)

## Example: Model W4TXNFWQ Schematic

120 Volts 60 Cycle AC

Water Valve Optional On Ice Maker Kit Models

Components within dashed line can be part of a module

14 cu. Ft. Top Mount Refrigerator Static Condenser

Forced Air Evaporator

Cumulative Wired Defrost Timer

Optional Ice Maker Kit Available Compressor Starting Components can be individual components or contained in a plug on module

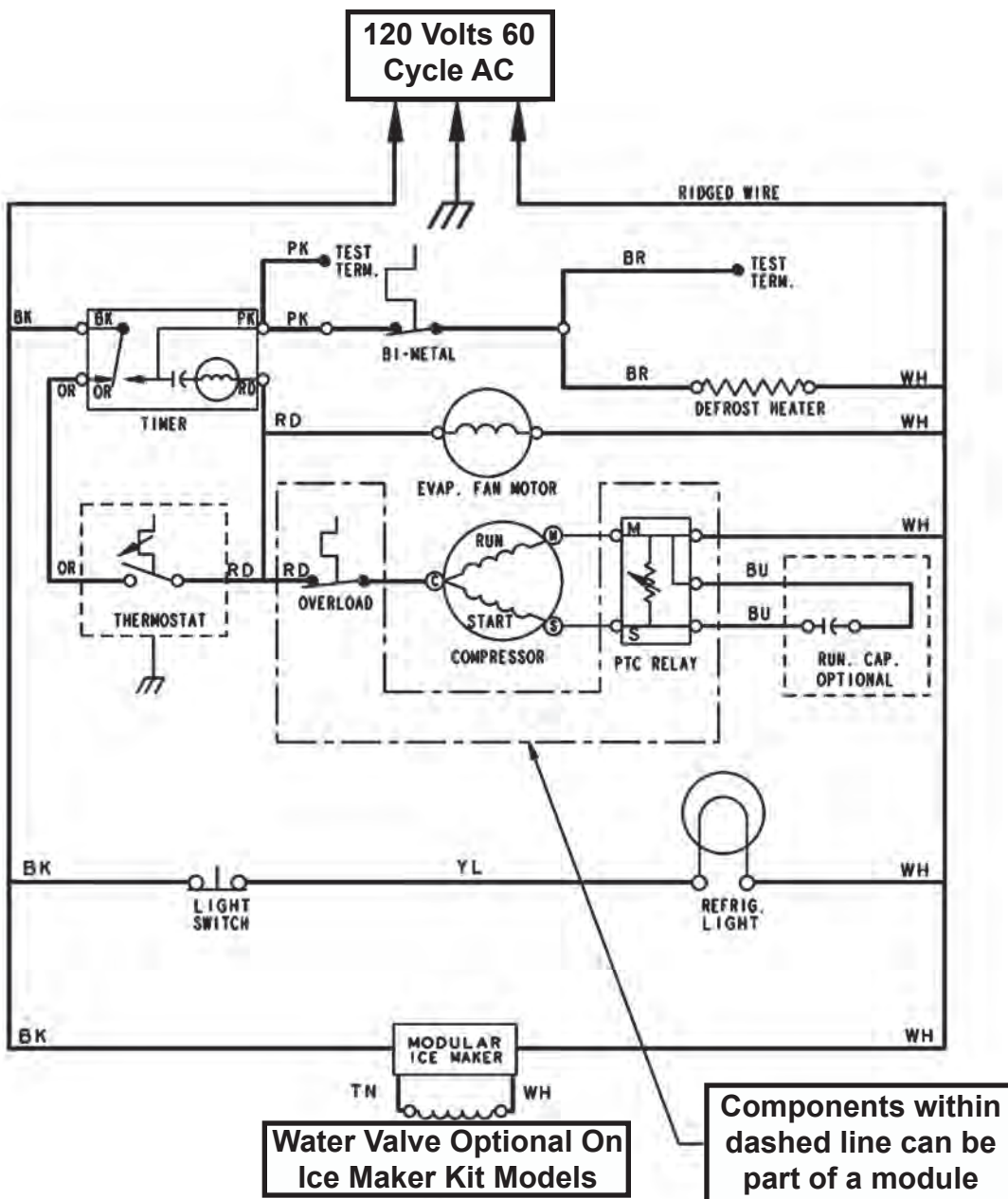

# TROUBLESHOOTING AND DIAGNOSIS

## General

### Heavy warm load

The amount of warm food placed in the refrigerator affects running time and power consumption. Ordinarily, when a supply of food is placed in a refrigerator, it will operate continuously until the food is cooled down to the desired storage temperature. This continuous operation is normal. In high ambient room temperatures, an excessive warm load may cause overload cycles.

### Excessive door opening

The length of time the door is left open and the number of times the door is opened should be kept to a minimum. Excessive door opening will greatly increase running time, power consumption and frost buildup.

**IMPROPER PACKAGING** Uncovered foods and improper packaging materials and methods cause food to dry out. This reduces the flavor of foods and results in an excessive frost buildup. Refer the customer to the use and care guide that came with the refrigerator for proper package and storage recommendations.

### WARM ROOM

1. A warm room or other large source of heat (such as a range, heater, hot air duct, sunny window) can affect the performance of the refrigerator. If the ambient temperature exceeds 100°F, running time will approach 100%.
2. At temperatures approaching 120°F, the refrigerator will not maintain temperature and may cycle on the overload.
3. In general, the warmer the room, the longer the running time and the greater the power consumption.

### Exterior sweating

Refrigerators are designed to avoid “runoff” moisture at ambient room temperatures of 90°F and relative humidity of 90%. There may be a thin film of moisture on some areas at a lower temperature and relative humidity. This is within design specifications and is not a fault of construction.

Relocating the refrigerator in a less humid and better ventilated area will normally eliminate moisture problems.



# Troubleshooting And Diagnosis (continued)

Try the solutions suggested here first in order to avoid the cost of an unnecessary service call.

Your refrigerator will not operate

## **WARNING**



### **Electrical Shock Hazard**

**Disconnect power before servicing.**

**Replace all parts and panels before operating.**

**Failure to do so can result in death or electrical shock.**

- Is the power supply cord unplugged? Plug into a grounded 3 prong outlet.
- Has a household fuse blown, or has a circuit breaker tripped? Replace the fuse or reset the circuit breaker. If the problem continues, call an electrician.
- Is the Temperature Control turned to the OFF position? See "Using the Control(s)."
- Is the refrigerator defrosting? Recheck to see whether the refrigerator is operating in 30 minutes. Your refrigerator will regularly run an automatic defrost cycle.

The lights do not work

- Is a light bulb loose in the socket or burned out? See "Changing the Light Bulbs."

There is water in the defrost drain pan

- Is the refrigerator defrosting? The water will evaporate. It is normal for water to drip into the defrost pan.
- Is it more humid than normal? Expect that the water in the defrost pan will take longer to evaporate. This is normal when it is hot or humid.

The motor seems to run too much

- Is the room temperature hotter than normal? Expect the motor to run longer under warm conditions. At normal room temperatures, expect your motor to run about 40% to 80% of the time. Under warmer conditions, expect it to run even more of the time.
- Has a large amount of food just been added to the refrigerator? Adding a large amount of food warms the refrigerator. It is normal for the motor to run longer in order to cool the refrigerator back down. See "Refrigerator Features."
- Are the doors opened often? Expect the motor to run longer when this occurs. In order to conserve energy, try to get everything you need out of the refrigerator at once, keep food organized so it is easy to find, and close the door as soon as the food is removed.
- Is the control set correctly for the surrounding conditions? See "Using the Control(s)," depending on the model.
- Are the doors closed completely? Push the doors firmly shut. If they will not shut all the way, see "The doors will not close completely" later in this section.

NOTE: Your new refrigerator will run longer than your old one due to its high-efficiency motor.

The refrigerator seems to make too much noise

- The sounds may be normal for your refrigerator. See "Normal Sounds."

The ice maker is not producing ice or not enough ice

- Has the ice maker just been installed? Wait 72 hours for full ice production to begin. Once your refrigerator is cooled, the ice maker should produce 70-120 cubes every 24 hours.
- Is the freezer temperature cold enough to produce ice? Wait 24 hours after hookup for ice production. See "Using the Control(s)," depending on the model.
- Is the wire shutoff arm in the OFF (arm up) position? Lower the wire shutoff arm to the ON (arm down) position. See "Ice Maker."

# Troubleshooting And Diagnosis (continued)

- Is the water line shutoff valve to the refrigerator turned on? Turn on the water valve. See “Connect the Water Supply.”
- Does the ice maker mold have water in it or has no ice been produced? Be sure your refrigerator has been connected to a water supply and the supply shutoff valve is turned on. See “Connect the Water Supply.”
- Is an ice cube jammed in the ejector arm? Remove the ice from the ejector arm with a plastic utensil. See “Ice Maker.”
- Has a large amount of ice just been removed? Allow 24 hours for ice maker to produce more ice.
- Is the control set correctly? If too little ice is produced, see “Using the Control(s),” depending on the model.
- Is a reverse osmosis water filtration system connected to your cold water supply? See “Water Supply Requirements.”

**NOTE:** If not due to any of the above, there may be a problem with the water line. Call for service.

## Off-taste or gray color in the ice

- Are the plumbing connections new, causing discolored or off-flavored ice? Discard the first few batches of ice.
- Have the ice cubes been stored for too long? Throw away old ice and make a new supply.
- Has food in the refrigerator been wrapped properly? See “Refrigerator Features.”
- Do the freezer and ice bin need to be cleaned? See “Cleaning.”
- Does the water contain minerals (such as sulfur)? A filter may need to be installed to remove the minerals.

## The divider between the two compartments is warm

The warmth is probably due to normal operation of the automatic exterior moisture control. If still concerned, call for service.

## Temperature is too warm

- Are the air vents blocked in either compartment? This prevents the movement of cold air from the freezer to the refrigerator. Remove any objects from in front of the air vents. See “Ensuring Proper Air Circulation” for the location of air vents.
- Are the door(s) opened often? Be aware that the refrigerator will warm when this occurs. In order to keep the refrigerator cool, try to get everything you need out of the refrigerator at once, keep food organized so it is easy to find, and close the door as soon as the food is removed.
- Has a large amount of food just been added to the refrigerator or freezer? Adding a large amount of food warms the refrigerator. It can take several hours for the refrigerator to return to the normal temperature.
- Are the controls set correctly for the surrounding conditions? See “Using the Control(s),” depending on the model.

## There is interior moisture buildup

- Are the air vents blocked in the refrigerator? Remove any objects from in front of the air vents. See “Ensuring Proper Air Circulation” for the location of air vents.
- Are the door(s) opened often? To avoid humidity buildup, try to get everything you need out of the refrigerator at once, keep food organized so it is easy to find, and close the door as soon as the food is removed. When the door is opened, humidity from the room air enters the refrigerator. The more often the door is opened, the faster humidity builds up, especially when the room itself is very humid.
- Is the room humid? It is normal for moisture to build up inside the refrigerator when the room air is humid.
- Is the food packaged correctly? Check that all food is securely wrapped. Wipe off damp food containers before placing in the refrigerator.
- Are the controls set correctly for the surrounding conditions? See “Using the Control(s),” depending on the model.
- Was a self-defrost cycle completed? It is normal for droplets to form on the back wall after the refrigerator self-defrosts.

## The doors are difficult to open

**⚠ WARNING**



**Explosion Hazard**  
**Use nonflammable cleaner.**  
**Failure to do so can result in death, explosion, or fire.**

- Are the gaskets dirty or sticky? Clean gaskets and the surface that they touch. Rub a thin coat of paraffin wax on the gaskets following cleaning.

## The doors will not close completely

- Are food packages blocking the door open? Rearrange containers so that they fit more tightly and take up less space.
- Is the ice bin out of position? Push the ice bin in all the way.
- Are the crisper cover, pans, shelves, bins, or baskets out of position? Put the crisper cover and all pans, shelves, bins, and baskets back into their correct positions. See “Refrigerator Features.”
- Are the gaskets sticking? Clean gaskets and the surface that they touch. Rub a thin coat of paraffin wax on the gaskets following cleaning.
- Does the refrigerator wobble or seem unstable? Level the refrigerator. See “Adjust the Doors.”
- Were the doors removed during product installation and not properly replaced? Remove and replace the doors according to “Refrigerator Doors,” or call a qualified service technician.

# Troubleshooting And Diagnosis (continued)

## Real vs. Perceived problems

The most difficult service complaint that you'll encounter is the one that deals with marginal performance. Very often there is nothing wrong with the appliance. Rather, the problem is one of customer expectations. The customer feels that the appliance is not working as well as it should. The key to dealing with this type of problem is understanding both the capabilities of the appliance and the customer's perception of the malfunction. As a technician, you cannot redesign the refrigerator to make it do something that it wasn't engineered to do. If the customer expectations exceed the performance limits of the appliance, you should be able to explain those limits in a professional and courteous manner.

## Marginal Performance

When actually encountered, marginal performance problems can be very challenging. A complete failure is almost always easier to diagnose. The difficulty often lies in establishing what is acceptable performance and what isn't. In other words, at what point does the performance fall below the permissible level for the appliance? In most cases, the customer is sole judge of what is acceptable. But that doesn't mean that you'll always be able to please the customer. Nor should you always try. To replace a functional part just to pacify a customer is counter-productive. Ultimately, replacing parts indiscriminately only antagonizes the customer. Don't forget that when you replace a part, the customer expects the performance of the appliance to improve. If it doesn't, your credibility and professionalism will be questioned. There is a logical process that can be followed when dealing with marginal performance problems.

Steps involved:

- 1. Listen to the customer complaint.** Remember that the customer lives with the appliance every day and is more familiar with its routine of operation. If something has changed, the customer is always the first to notice. Ask questions. How has the performance changed? Is the appliance being used differently? Is this a consistent problem?
- 2. Verify the performance of the refrigerator.** Use available information, test equipment and your knowledge of the refrigerator and its operation to evaluate the overall performance of the refrigerator.
- 3. Compare the conditions encountered to the known performance criteria.** Pertinent data is normally included in the technical data sheets that are packed with the refrigerator. For example, thermostat temperature ranges, water pressure requirements, and compressor run wattage can all be used to determine if the refrigerator is performing as designed. Minimum and maximum guidelines are often established—such as the water pressure requirements of an ice maker. Once you've determined that the performance has changed, isolate the probable causes. Review the causes in your mind. What conditions could lead to the reduction in efficiency? Has a part failed or are there external factors at work? Very often a refrigerator behaves differently because its environment has changed. External changes often affect performance.

# Troubleshooting And Diagnosis (continued)

## Basic Steps to Using Diagrams in Troubleshooting

Basic steps should be followed when troubleshooting a refrigerator with the aid of a diagram. Each step should systematically reduce the number of variables until the one component that is causing the problem is isolated. This process is much like using a series of maps to find a particular address. If you were an unfamiliar visitor to the U.S. and were asked to find an address in a small town, you would probably start by consulting a U.S. map to find the state where the town was located. Next, you would use a state map to find the town; and finally, a town map to find the wanted street. Just as you wouldn't use a map of the U.S. to find a city street, you wouldn't use the entire diagram to locate the failure of one component.

The following guidelines should be used to narrow the failure down to one circuit or component:

- 1. Be sure you understand the failure.** All too often time is spent looking for problems that don't exist or looking in the wrong part of the circuitry because the technician hasn't taken the time to fully understand what the symptoms are indicating. Any good troubleshooting method must begin with a thorough assessment of all the conditions. In most appliances, it's unusual for more than one failure to occur at a time. By analyzing what operational steps and components are still functional, the failed step or component often becomes easier to isolate.
- 2. Make use of your senses before proceeding.** Listen to what the customer is telling you about the failure. Listen to the appliance while it's operating. Feel the parts, if you can do so safely. Burned or overheating parts usually give off a strong odor. Look for the obvious. Your senses can often indicate where to begin.
- 3. Isolate the failure to a suspected area.** There's no sense in checking the entire refrigerator when only one part or function is not operating. Once you've isolated the problem to a specific area of the machine, the diagram can then be used to guide you through the tests that will be required to verify your suspicions. The existing conditions must be compared to the ideal parameters outlined by the technical data and diagram to arrive at the probable cause of the circuit failure.
- 4. Determine how the loads are electrically distributed in the suspected area.** In most diagrams, there are distinct legs that supply voltage to each separate load. By identifying each leg, the loads can be isolated from each other and the unaffected portions of the circuit can be ignored.

## Troubleshooting And Diagnosis (continued)

### **⚠ DANGER**



#### **Electrical Shock Hazard**

**Only authorized technicians should perform diagnostic voltage measurements. After performing voltage measurements, disconnect power before servicing. Failure to follow these instructions can result in death or electrical shock.**

### **⚠ WARNING**



#### **Electrical Shock Hazard**

**Plug into a grounded (earthed) outlet. Replace all parts and panels before operating. Failure to do so can result in death or electrical shock.**

#### **Voltage Measurement Safety Information**

When performing live voltage measurements, you must do the following:

- Verify the controls are in the off position so that the appliance does not start when energized.
- Allow enough space to perform the voltage measurements without obstructions.
- Keep other people a safe distance away from the appliance to prevent potential injury.
- Always use the proper testing equipment.
- After voltage measurements, always disconnect power before servicing.

**To check for proper voltage, complete the following steps:**

- 1. Disconnect power**
- 2. Connect voltage measurement equipment.**
- 3. Reconnect power and confirm voltage reading.**
- 4. Disconnect power after performing voltage measurement.**
- 5. Start your checks at the component that you suspect and work back from the component to the line.** Since most functional components are wired directly across the line, a voltage check at the suspected component can further isolate the failure. If the proper voltage is present and the component isn't functioning, the component is most likely bad and must be replaced (unless there is mechanical reason that is keeping the component from operating). If the voltage is missing, one of the control devices (such as a defrost timer switch, thermostat, overload, etc.) has failed and further checks must be made. As you work back to the line, the point at which line voltage is measured designates the very next component that should be tested.
- 6. Use your knowledge of the refrigerator and components to assist you in your diagnosis.** If, for example, two components are wired in parallel and one is working and the other isn't, there's no reason to check the components that control that leg of the circuit. If one of the controls was not functional, neither component would operate.
- 7. Think logically and arrive at sound conclusions.** The ability to think and see clearly is not a skill that can be taught through a textbook of this type. But, like any other skill, it can be developed. You must make a conscious effort to apply logic and common sense every time that you pick up a diagram. Over time, many of these guidelines will become second nature to you. But like any process, it must be used consistently before it can be mastered.

# Troubleshooting And Diagnosis (continued)

## Mechanical failure analysis

Finding the failed part is just the beginning. Once the defective component is isolated, it's important to look beyond the initial problem. There is a reason for component failures. Sometimes the reason is not readily apparent (or is beyond your ability to correct) but all failures fall into one of the following categories:

- 1. Normal wear and tear.** Parts do wear out. The more a part is used the greater the chance of failure and, eventually, every part will wear out. A certain life expectancy is designed into every part and any Premature failure should be investigated.
- 2. Failure to follow manufacturer's maintenance instructions.** Maintenance requirements vary from appliance to appliance. Some require very little customer maintenance while others must be maintained on a regular basis. In either case, the recommended maintenance procedures are outline in the customer's owner's manual. Failure to follow the manufacturer's recommendations will accelerate the failure of some components.
- 3. Customer abuse.** There are limitations to the capabilities of all appliances. For example, repeated failure of shelving, crisper drawers etc. due to misuse or over loading. This invites premature failure of the appliance parts
- 4. Outside influences.** Operating a refrigerator in a ambient temperature below 55 degrees or above 95 degrees can damage the compressor or associated starting components.
- 5. Manufacturing defects.** Although uncommon, there are times when a part is incorrectly manufactured or the wrong materials are used in its construction. These failures tend to repeat themselves among refrigerators of the same model and should be reported to a supervisor or manufacturer's representative so that the problem can be corrected. The manufacturer normally issues a service flashes or service pointer based on these field reports.
- 6. Improper application of parts.** Most parts are designed for a specific purpose. Any application other than that specified is inviting premature failure. (Only approved parts should be used in the repair of any appliance.)
- 7. Electrical Overloading.** Switch contacts, for example, are designed to withstand and sustain a specific current draw. When the design current is exceeded, contacts will overheat and self-destruct. To replace the switch without checking for the cause of the failure would only accomplish half of the repair.
- 8. Mechanical Overloading.** A part that is subjected to greater mechanical stress than intended will eventually fail.

## Troubleshooting And Diagnosis (continued)

**9. Electrical stress.** Voltages other than those specified by the manufacturer will eventually destroy a component. While higher than normal voltages are certainly a cause for concern for any component, lower than normal voltages will more readily affect inductive devices such as motors. Low voltage is more problematic during motor start. Of all the reasons listed, overloading, mechanical and electrical stress are the ones that most easily translate into repeated service requests (or recalls). No one, not the technician, customer, or company-benefits from recalls. Looking beyond the initial problem is as much a part of the job as replacing defective parts and completing the service order. As with anything else, however, a balance needs to be maintained between fixing the appliance correctly and playing investigative reporter. Not every failure requires extensive analysis. Nor is it necessary to always take components apart to determine their failure. What is necessary is that some thought be given to why the part failed and the resulting consequences of the failure. What caused the failure? What other components might have been affected as a result of the failure? A repair that inspires confidence from both the technician and the customer requires an answer to both of these questions.

# Troubleshooting And Diagnosis (continued)

## Analyzing Compressor Failures

Compressors, like any other part, fail for a reason. Compressors are designed to last the life-time of a refrigerator. The life span of a compressor can be greatly reduced if it's operated in very hot climates, areas of constant power reductions, or if the usage is greater than normal. Still, every compressor failure should be analyzed to insure that the replacement compressor doesn't suffer the same fate as the original.

### Low Voltage Effect on Compressors

Low voltage to a compressor-or any motor, for that matter-is a killer. Low voltage reduces motor speed and increases current draw. The higher than normal current overheats windings and destroys wire insulation, causing windings to short and burn out. Loose connections at the outlet (or breaker box), overloaded circuits, use of an extension cord or even insufficient supply from the local utility can all cause the voltage to the compressor to fall below the required minimum. Regardless of the reason, the voltage problem must be corrected before the new compressor can be installed. Whether the problem is with the local utility or localized in the customer's home, the problem needs to be rectified.

### Defining "Normal" Voltage

In most areas, normal line voltage is 120VAC  $\pm$ 10%. Of course, voltage will vary from region to region and you should check with your local utility to determine what is normal for your area. Assuming 120 volts as our standard, the 10% variance allows the voltage to fluctuate between 108 and 132VAC. Most compressor motors will overheat at voltages above 132VAC and will not function properly once the voltage drops below 108VAC. While excessive voltage is rare, low voltage is a more common problem. In summer, it's not unusual for utilities to reduce the voltage they supply to their customers during peak air conditioning demand periods (creating brown outs). If, in addition to the lower voltage supplied by the utility, the home also has wiring problems, it's possible for the supply voltage to drop well below the allowed 10% during these peaks.

### Testing for Low Voltage

A simple voltage check at the outlet will not necessarily verify a low voltage problem. Unless the outlet is under load, the voltage may well read in the normal range. Once under load, however, the voltage can drop considerably. It's important, therefore, that the voltage be checked under load. If the voltage drops more than 10% while the compressor attempts to start, the supply is inadequate and the customer must be instructed to have the wiring problem corrected. Under no circumstances should you attempt to correct the problem yourself.



# Troubleshooting And Diagnosis (continued)

## Isolating Compressor Failures

A clicking noise coming from the back of the refrigerator tells you that the overload is tripping whenever the compressor attempts to start. Overloads usually fail in the open position. So, if you find one that's clicking (making and breaking the circuit), it's doing exactly what it was designed to do and there's little point in testing the overload first. Find out what is causing the excess heat or current condition. Chances are that the compressor is at fault. Once you've determined that the compressor has failed, it will be necessary to isolate the cause. Why did the compressor fail? Was it the voltage supply or were there other reasons? After checking the compressor terminals for leakage to ground, a voltmeter can be used to verify the condition of the power supply. An inadequate supply will show up regardless of the type of load that is connected to it—as long as the current requirement of the load is comparable to that of the compressor. A heat gun or ordinary iron can also be used to test the outlet. If the voltage drops when either of these two is plugged in, the supply is defective and will have to be repaired. If the compressor does not start and the supply is not the problem, further analysis is needed. A few things to look for include:

- 1. Restricted air movement across condensing coil.** Stopped or slow moving fan motors and/or a blocked condenser coil will reduce the airflow and restrict proper cooling of the compressor. Furthermore, the compressor will run for extended periods if the heat picked up by the refrigerant is not removed from the condenser.
- 2. Improper installation.** The refrigerator must not be installed in enclosed areas and must have the proper clearance around it to allow unrestricted air movement. Ranges and other high heat sources should be installed far enough away to avoid heat from radiating directly onto refrigerator exterior walls. High humidity areas, such as utility rooms, should be avoided. (Moisture contains a great deal of latent heat that must be removed causing the compressor to run for longer periods of time.) Garages and other unconditioned rooms should also be avoided since very high temperatures in summer will force the compressor to run extensively; very cold temperatures may cause the refrigerant to return to the compressor in liquid state.
- 3. Defective relays.** Pitted relay contacts can reduce the current available to the start winding. Welded contacts will keep the start winding energized at all times.
- 4. Defective overload,** thermostat or timer contacts. High resistance connections at the contacts can greatly reduce the current available to the compressor during start.
- 5. Welded timer contacts can keep the defroster heater on all of the time.** The additional heat load will not only affect the storage temperatures of the refrigerator but put additional burden on the compressor.
- 6. Air leaks.** Air leaking into the refrigerator not only overburdens the defrost system but puts additional strain on the compressor since the refrigerator will have to run longer to remove the latent heat present in the air.

# **PRODUCT SPECIFICATIONS AND WARRANTY INFORMATION SOURCES**

***IN THE UNITED STATES:***

**FOR PRODUCT SPECIFICATIONS AND WARRANTY INFORMATION CALL:**

**FOR WHIRLPOOL PRODUCTS: 1-800-253-1301**

**FOR KITCHENAID PRODUCTS: 1-800-422-1230**

**FOR ROPER PRODUCTS: 1-800-447-6737**

**FOR TECHNICAL ASSISTANCE WHILE AT THE CUSTOMER'S HOME CALL:**

**THE TECHNICAL ASSISTANCE LINE: 1-800-253-2870**

**HAVE YOUR STORE NUMBER READY TO IDENTIFY YOU AS AN  
AUTHORIZED SERVICER**

**FOR LITERATURE ORDERS:**

**PHONE: 1-800-851-4605**

**FOR TECHNICAL INFORMATION AND SERVICE POINTERS:**

**[www.servicematters.com](http://www.servicematters.com)**

---

***IN CANADA:***

**FOR PRODUCT SPECIFICATIONS AND WARRANTY INFORMATION CALL:**

**1-800-461-5681**

**FOR TECHNICAL ASSISTANCE WHILE AT THE CUSTOMER'S HOME CALL:**

**THE TECHNICAL ASSISTANCE LINE: 1-800-488-4791**

**HAVE YOUR STORE NUMBER READY TO IDENTIFY YOU AS AN  
AUTHORIZED SERVICER**

