

Contents

Introduction 3

Type overview 4

Programme 5

Indication of programme sequence 7

Options and settings 7

Variant settings 9

Test programme 10

Fault indications 12

Components and measurement values 13

Technical data 15

Circuit diagram 16

Timer diagram 18

This service manual describes washing machine type WM25 and is a supplement to the general service manual for the 600 series.



Revision history

Revision	Date	Description	Initials
02	2008-04-28	WM25.2 can be specified with display, hence change type from WM25.2 to WM25.3	MW
		Delayed Start 1-24h implemented W723	MW
		CIM motor (brushless)	

Introduction

You are holding the service manual for the WM25 generation of washing machines.

There are three types of washing machine in the WM25 series: WM25.1, WM25.2, WM25.3. The following page presents the different versions, to help you identify the machine types. The variants are named differently from market to market. The type designation is the most important factor for identifying the machine type. The type designation can be found on the machine plate, which is located inside the machine's door.

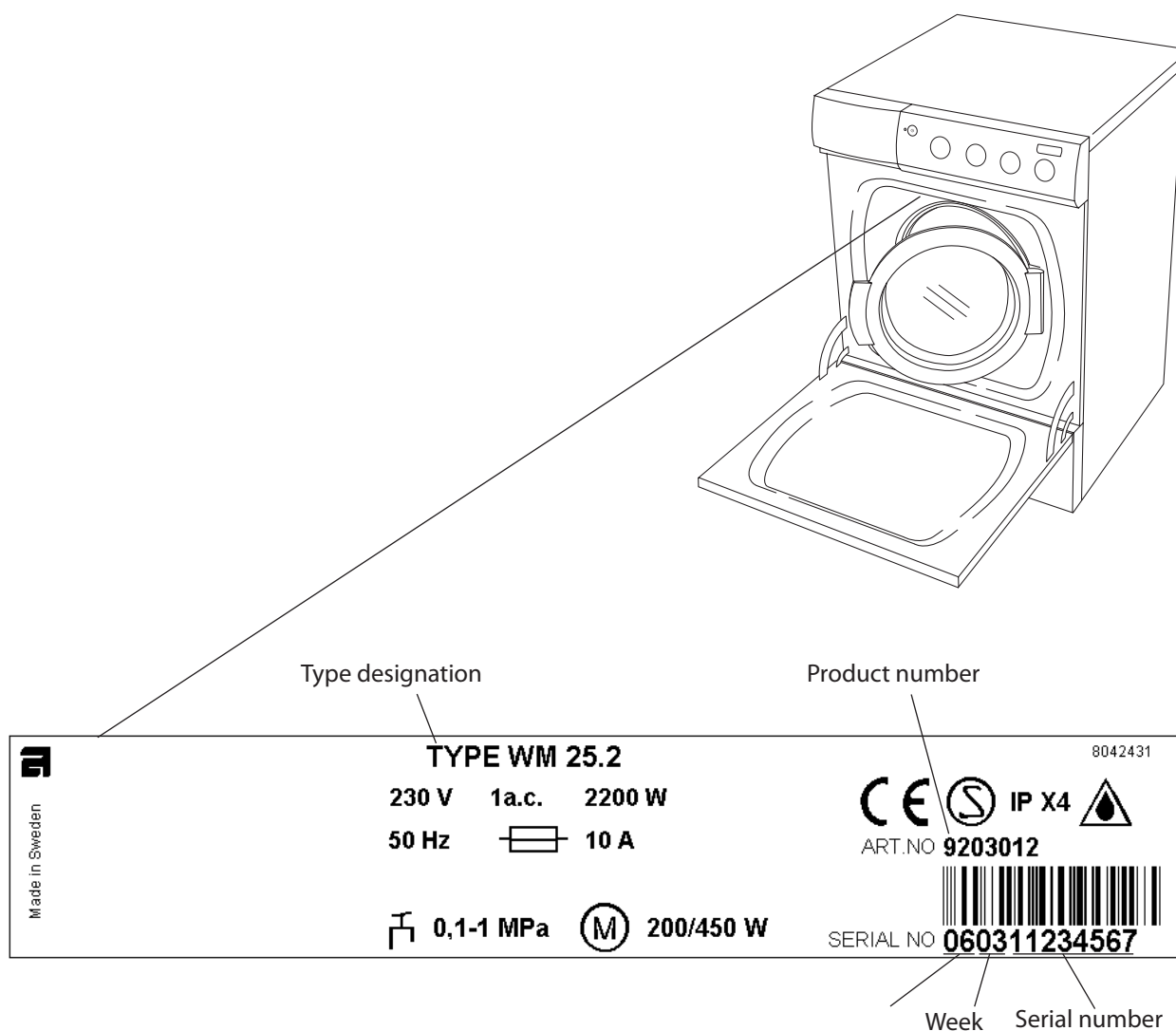

It should be easy to service a washing machine. It is important that you, as a service technician, are given the conditions to be able to carry out work in an efficient and satisfactory way. Our hope is that this service manual is a useful tool for your daily work.

Type overview

WM25.1 (USA)



- Programme: 4 (For further information, see timer diagram at the foot of the document.)
- Options: 2 (For further information, see directions for use)
- Settings: None.

WM25.2 (B)



- Programme: 10 (For further information, see timer diagram at the foot of the document.)
- Options: 1 (designations differ depending on the market, see directions for use.)
- Settings: None.
- Display can be specified With display and Delayed start 1-24h

WM25.3 (C/CI)



- Programme: 10 (For further information, see timer diagram at the foot of the document.)
- Options: 1 (designations differ depending on the market, see directions for use.)
- Settings: 2 (designations differ depending on the market, see directions for use.)
- Delayed start 5h delayed start, from week 723 1-24 delayed start
- CIM-motor Spin speed 400-1600 rpm

WM25.3 (D/DI)

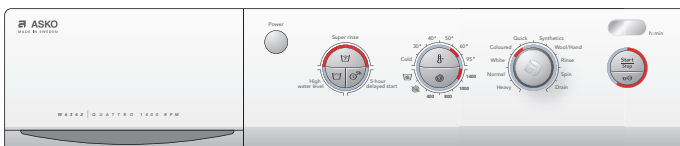

- Programme: 10 (For further information, see timer diagram at the foot of the document.)
- Options: 2 (designations differ depending on the market, see directions for use.)
- Settings: 2 (designations differ depending on the market, see directions for use.)
- Delayed start 5h delayed start, from week 723 1-24 delayed start
- CIM-motor Spin speed 400-1600 rpm

Programme

WM25.1 (USA)

Programme	Pre-wash	Main wash	Temperature °F	End spin cycle	Max rpm	Max load	Short spin (number)	Rinses (number)	Water consumption (approx. litres)	Energy consumption (approx. kWh)	Programme time (approx. min)
White	No	Long	140	Long	1200	1/1	2	5	69	1,14	140
Colour	No	Short	105	Long	1200	1/1	2	5	69	0,5	75
Synthetic	No	Short	105	Short	800	1/2	0	3	30	0,3	65
Hand wash/Wool	No	Short	85	Short	800	1/3	0	3	54	0,3	40

WM25.2 and WM25.3

Machine pre-programmed for 3 rinses												
Programme	Pre-wash	Main wash	Temp°C	Final spin	Max speed(rpm)	Max. load	Short spin (number)	Rinses (number)	Water consumption (approx. litres)	Energy (approx. kWh)	Programme time (approx. min)	
Programme 1	Yes	Long	95	Long	1400	1/1	3	5	80	2,1	170	
Programme 2	No	Long	60	Long	1400	1/1	3	3	54	1,02	130	
Programme 3	No	Short	60	Long	1400	1/1	3	3	50	1,1	107	
Programme 4	No	Short	40	Long	1400	1/1	3	3	45	0,5	70	
Programme 5	No	Short	40	Long	1400	1/2	0	2	25	0,4	40	
Programme 6	No	Short	40	Short	800	1/2	0	3	40	0,4	80	
Programme 7	No	Short	30	Short	800	1/3	0	3	80	0,5	45	
Programme 8	No	-	-	Long	1400	1/1	0	1	15	0,1	20	
Programme 9	No	-	-	Long	1400	1/1	0	0	0	0,1	15	
Programme 10	No	-	-	-	-	-	0	0	0	-	1	

Machine pre-programmed for 5 rinses												
Programme	Pre-wash	Main wash	Tem°C	Final spin	Max speed(rpm)	Max. load	Short spin (number)	Rinses (number)	Water consumption (approx. litres)	Energy (approx. kWh)	Programme time (approx. min)	
Programme 1	Yes	Long	95	Long	1400	1/1	2	5	72	2,1	170	
Programme 2	No	Long	60	Long	1400	1/1	2	5	69	1,02	140	
Programme 3	No	Short	60	Long	1400	1/1	2	5	69	1,1	110	
Programme 4	No	Short	40	Long	1400	1/1	2	5	69	0,5	80	
Programme 5	No	Short	40	Long	1400	1/2	0	2	22	0,4	40	
Programme 6	No	Short	40	Short	800	1/2	0	3	30	0,4	80	
Programme 7	No	Short	30	Short	800	1/3	0	3	54	0,5	45	
Programme 8	No	-	-	Long	1400	1/1	0	1	9	0,1	20	
Programme 9	No	-	-	Long	1400	1/1	0	0	0	0,1	15	
Programme 10	No	-	-	-	-	-	0	0	0	-	1	

The programme is tested in accordance with EN 60456/A11/A12/.

WM25.3 CIM-motor

Machine pre-programmed for 3 rinses											
Programme	Pre-wash	Main wash	Temp°C	Final spin	Max speed(rpm)	Max. load	Short spin (number)	Rinses (number)	Water consumption (approx. litres)	Energy (approx. kWh)	Programme time (approx. min)
Programme 1	Yes	Long	95	Long	1600	1/1	3	5	80	2,1	170
Programme 2	No	Long	60	Long	1600	1/1	3	3	54	1,02	135
Programme 3	No	Short	60	Long	1600	1/1	3	3	55	1,1	135
Programme 4	No	Short	40	Long	1600	1/1	3	3	35	0,8	75
Programme 5	No	Short	40	Long	1600	1/2	0	2	35	0,4	50
Programme 6	No	Short	40	Short	800	1/2	0	3	40	0,4	80
Programme 7	No	Short	30	Short	800	1/3	0	3	80	0,5	45
Programme 8	No	–	–	Long	1600	1/1	0	1	15	0,1	20
Programme 9	No	–	–	Long	1600	1/1	0	0	0	0,1	15
Programme 10	No	–	–	–	–	–	0	0	0	–	1

Machine pre-programmed for 5 rinses											
Programme	Pre-wash	Main wash	Tem°C	Final spin	Max speed(rpm)	Max. load	Short spin (number)	Rinses (number)	Water consumption (approx. litres)	Energy (approx. kWh)	Programme time (approx. min)
Programme 1	Yes	Long	95	Long	1600	1/1	2	5	80	2,1	170
Programme 2	No	Long	60	Long	1600	1/1	2	5	69	1,02	145
Programme 3	No	Short	60	Long	1600	1/1	2	5	69	1,1	145
Programme 4	No	Short	40	Long	1600	1/1	2	5	55	0,9	80
Programme 5	No	Short	40	Long	1600	1/2	0	2	35	0,4	50
Programme 6	No	Short	40	Short	800	1/2	0	3	40	0,4	80
Programme 7	No	Short	30	Short	800	1/3	0	3	80	0,5	45
Programme 8	No	–	–	Long	1600	1/1	0	1	15	0,1	20
Programme 9	No	–	–	Long	1600	1/1	0	0	0	0,1	15
Programme 10	No	–	–	–	–	–	0	0	0	–	1

Indication of programme sequence

During the programme, the current programme sequence is indicated by a fixed light in the LEDs around the start/stop/door open button (see the image).

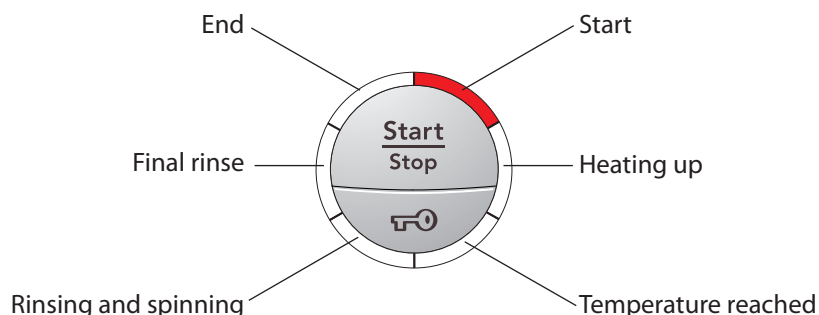

Options and settings

Options



Increases the temperature and extends the time of the main wash
This option is only available on the American market.

White:

140°F / 170°F + approx 40 min

Colours:

105°F / 120°F + approximately 40 min

Permanent
press:

105°F / 120°F + approximately 15 min



Gives 2 – 4 extra rinses

This option cannot be selected with Wool/Hand wash, Rinse programme, Spin or Drain.



Machines without display

Delays the start of the machine by 5 hours

Activated by pressing the "Delayed start" button and then the start/stop button.

The number 5 in the display indicates that Time-delayed start has been activated. The number of hours to start is displayed with a countdown from 5 to 1.



Machines with display

Start machine with 5 hour delay

Activated by pressing the "Delayed Start" button and then the Start/Stop button

The number 5 is shown on the display to indicate that Delayed Start is activated.

The number of hours to start is shown in a countdown from 5 to 1.



1 - 24h delayed start successively from week 723

Start machine with 1-24 hour delay. Activated by pressing the Delayed Start option button as many times as the desired number of hours' delay before start (1-24 h) and then pressing the Start/Stop button. The number of hours to delayed start is shown on the display. The number of hours to start is shown in a countdown that decreases 1 hour at a time.



Produces extra water in the main wash and rinses
Cannot be selected for wool/ hand wash, spinning and draining

Settings

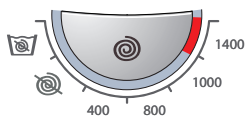

It is possible to select spin speed between 400 and 1400 rpm, CIM-motor between 400 och 1600 rpm, "No spin" and "No draining" (option depending on machine type).

Spin at 400 – 800 rpm means a short spin.

For certain programmes, it is not possible to select a speed in excess of 800 rpm.

"No spin" means that the programme does not include a spin cycle and ends by draining.

"No draining" means that the programme does not include a spin cycle and ends with the water from the final rinse still in the machine.

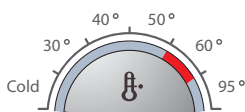

Possible to select temperatures between "Cold" and 95°C.

With "Cold" selected, the water in the machine is not heated.

Programme number 7 does not allow a temperature above 40°C to be selected.

Variant settings

The variable settings below can only be made on a replacement card

S = Push button
L = LED

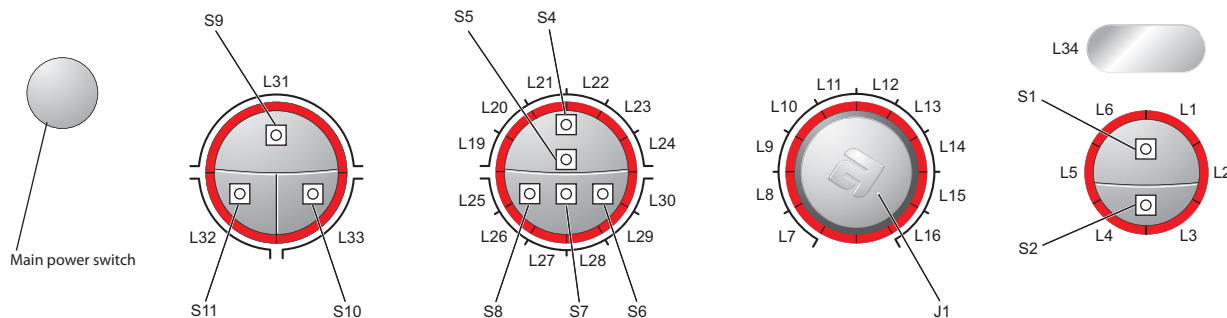

Total reset

1. Hold the start/stop button (S1) in when you switch on the main power switch until an LED on the panel lights.

Number of rinses

1. Hold both the start/stop button (S1) and door open button (S2) pressed in when you switch on the main power switch until L7 – L16 flash.
2. Change the number of rinses by pressing the door open button (S2) repeatedly. L1 – L3 light for three rinses. L1 – L5 light for 5 rinses.
3. Confirm your selection by pressing the start/stop button (S1).

Automatic door opening

1. Hold the door open button (S2) pressed in when you switch on the main power switch until L7 – L16 flash.
2. Change the setting by pressing the door open button (S2). L3 and L4 light when automatic door opening is selected.
3. Confirm your selection by pressing the start/stop button (S1).

Super rinse or Delayed Start

1. Hold S5 or S6 pressed in when you switch on the main power switch until L7 – L16 flash.
2. Change the setting by pressing S5 or S6. All LEDs L19 – L30 light for delayed start.
3. Confirm your selection by pressing the start/stop button (S1).

Temperature/Spin speed or Stain/Super rinse

1. Hold S4 pressed in when you switch on the main power switch until L7 – L16 flash.
2. Change the setting by pressing S4. All LEDs L19 – L30 light for Stain/Super rinse.
3. Confirm your selection by pressing the start/stop button (S1).

The control unit automatically senses and adapts to the panel layout and machine model when you press the S4 or S5 button.

Test programme

The entire test programme is run in a sequence as follows. You can cancel the test programme at any time during the programme by pressing the main power switch.

S = Push button
L = LED

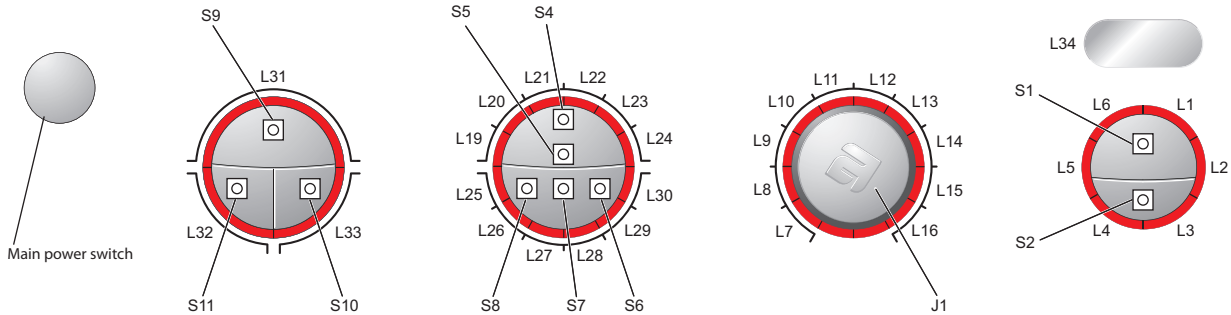

Total reset of programmes and starting test programme

To access the test programme, total reset of the programme must be carried out as follows:

1. Make sure that the main power switch is off.
2. Hold the start/stop button (S1) in and start the machine by pressing the main power switch.
3. Check that any of the LEDs around the programme knob (L7 – L16) light. This indicates that total reset has been carried out.

Testing LEDs

4. Press button S4/S5 and keep it depressed for approximately 20 seconds.

Note! This must be done within 3 seconds after carrying out total reset.

- All LEDs on the panel light up.

Testing inlet valves and water level (wash level)

5. Check that the door is closed.
6. Press the start/stop button (S1).
 - The entire display goes out except L6 (by the start/stop button), which starts to flash and continues to do so for the remainder of the test programme.
 - Valve 1 opens for 2 seconds.
 - Valve 2 opens for 2 seconds.
 - Valve 4 opens for 2 seconds.
 - Valve 2 opens until level P2 (wash level) is reached.
 - Valve 2 closes.

Indication of faults:

Fault indication/symptom	Cause
LED L1 flashes, the test programme stops and "End" is shown in the display (applies to machines with a display).	Level system/valve fault

Testing element, motor, thermistor, high level, for leakage, drain pump, spinning and door opening









7. Press the start/stop button (S1).
 - The element switches on.
 - The washing sequence starts.
 - The water is heated to 20°C.
 - The element switches off.
 - The washing cycle ends.
 - Valve 1 opens until level P6 (rinse level) is reached.
 - Valve 2 opens for 10 seconds.
 - Valve 4 opens for 10 seconds.
 - The washing sequence starts.
 - Leak test carried out for 20 minutes.
 - The drain pump runs until level P1 (empty machine) is reached.
 - The washing cycle ends.
 - Spinning at max rpm occurs for 1 minute.
 - The door opens.

Indication of faults:	
Fault indication/symptom	Cause
LED L1 and L2 flash.	Warming up fault: The temperature rises to 20°C within one minute.
LED L2 flashes.	Warming up fault : The temperature has not increased by 20°C within 10 minutes.
LED L3 flashes, the test programme stops and "End" is shown in the display (applies to machines with a display).	Fault at water intake (valve 1)
LED L4 and L5 flash, the test programme stops and "End" is shown in the display (applies to machines with a display).	Fault during leak test (pressure drop)
LED L4 flashes, the test programme stops and "End" is shown in the display (applies to machines with a display).	Fault during draining
LED L5 flash.	Fault during spin cycle

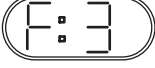
The test programme then stops automatically and "End" is shown in the display (applies to machines with a display).

Fault indications

The following faults are indicated by a flashing red light in the start/stop/door opening button LEDs and as a trouble code on the display (not on all machine versions).

Fault indication		Cause	Action
Display	LEDs (flashing)		
		Over filling. Too much water in the machine	Service action: 1. Check the machine's level system and inlet valve.
		Open the door	Customer information: 1. Close the door and start a programme. Service action: 1. Check the door lock.
		Drainage fault	Customer information: 1. Check that no objects are stuck in the drainage hose outlet. 2. Check that the drain pump is not blocked by foreign objects. 3. Check that there are no kinks in the drainage hose. Service action: 1. If the pump only runs for a short while (approximately 20 seconds), this indicates a fault in the level system. Check the level sensor and hoses. 2. Check wiring and voltage to the pump. If necessary, replace the pump and/or control 3. After implementing corrective action, run the Drain programme or press the Key button (door open) to empty the machine.
		Fault with water supply	Customer information: 1. Check that the tap on the water pipe is open. Service action: 1. Check that the filter in the machine's water intake is not blocked. 2. Check the inlet valve. If necessary, replace the valve. 3. Check voltage to the inlet valve. If there is no voltage, this could be due to a fault in the level system, wiring or control unit.
		Door opening fault	Service action: 1. Check for faults on the door lock or wiring to the door lock. 2. Check the function of the level sensor. 3. Check the control unit.

After carrying out corrective actions as above, reset the fault indications by switching off the machine using the main power switch.

Components and measurement values

Item number	Component	Measurement value	Comments
80 655 63	Motor 50 Hz	Resistances: Pins 2-3 stator 1.41 Ω Pins 1-3 stator 0.57 Ω Pins 4-5 rotor 1.54 Ω (measured diagonally across the collector) Pins 6-7 tachometer 135 Ω	All resistance values have tolerances of $\pm 8\%$.
80 658 33	CIM-motor	Resistances: Pins 1-3 stator 3,7 Ω Pins 1-2 stator 3,6 Ω Pins 2-3 rotor 3,6 Ω Pins 4-5 tachometer 178 Ω	
80 637 33	Motor 60 Hz	Resistances: Pins 2-3 stator 1.05 Ω Pins 1-3 stator 0.58 Ω Pin 4-5 rotor 1.75 Ω (Pins diagonally across the collector) Pins 6-7 tachometer 135 Ω	All resistance values have tolerances of $\pm 8\%$.
80 617 06	Heating Element 2000 W	28.4 Ω	
80 761 02	Thermistor	6.1-3.8 k Ω (at room temperature 20 – 30°C)	The thermistor for temperature reading is located between the motor cradle and the container. The thermistor measures and controls the water temperature that can vary from 0 to 90°C. The element is disconnected if the thermistor is short-circuited or disconnected from the programme control card.
88 012 63.	Drain pump 50 Hz	144 Ω .	The drain pump is combined with an integrated fine filter trap, which can be cleaned by the user. If the drain pump has run for 180 seconds during draining, the programme stops, resets and a trouble code is indicated in the display (on machines without a display, the LEDs flash).
88 012 64.	Drain pump 60 Hz	76 Ω	See above.
80 782 21	Level Switch		Electro mechanical level switch with two levels, see wiring diagram. Indicates levels for door opening, heat and overfilling.

Item number	Component	Measurement value	Comments
80 616 64	Pressure sensor	0.5 V out from the sensor (at 0 bar pressure and 230 V mains voltage, measurement carried out with the drain pump running to ensure 0 level is reached)	ASKO level sensor type 1166. Controls intake and level
80 762 02	EMC filter with inductor 50/60 Hz		The filter eliminates interference to and from the machine.
80 762 01	Inlet valve	3,7 k Ω \pm 0.5 k Ω	3 way inlet valve 10 litres / minute
80 616 79	Door lock	122 Ω	The door lock is electro mechanical and equipped with a magnet.
80 771 27	Control Unit WM25.1		
80 771 28	Control Unit WM25.2		
80 771 29	Control Unit WM25.3		
80 803 88	Control Unit WM25.3 CIM		
80 822 58	Frequency motor control		

Technical data

Height:	850 mm
Width:	595 mm
Depth:	585 mm
Weight:	73 kg / 78 kg (with outer door)
Cylinder volume:	50 l
Max. washing capacity:	6.0 kg
Spin speed max:	800/1400 rpm
Spin speed max: CIM motor max	800/1600 rpm
Connection:	1 phase 10 A
Element power:	See type plate.
Water pressure:	0,1 – 1 MPa., 1 – 10 kp/cm ² , 10 – 100 N/cm ²
Wash drum and liquid compartment material:	Stainless steel
Outer casing material:	Powder-coated and hot-galvanized sheet steel or stainless steel
Set-up:	Stationary on four adjustable, rubber-clad feet
Water connection:	1.5 m PEX tubing, 3/4" – 3/4" or 3/4" – 1/2"
Drain:	1.7 m polypropylene tubing
Protection class:	IP X4

Circuit diagram CIM motor

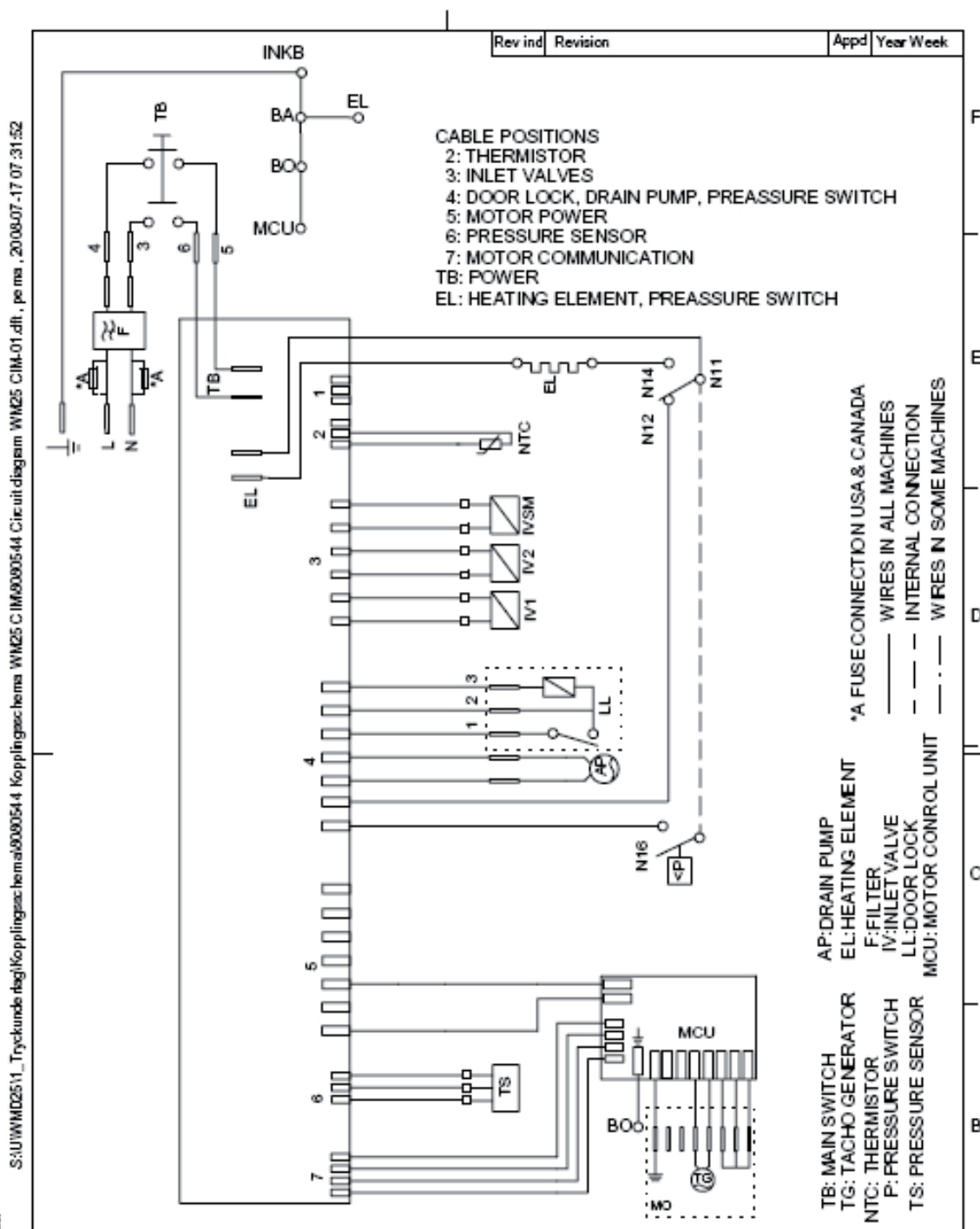

CABLE POSITIONS
 2: THERMISTOR
 3: INLET VALVES
 4: DOOR LOCK, DRAIN PUMP, PREASSURE SWITCH
 5: MOTOR POWER
 6: PRESSURE SENSOR
 7: MOTOR COMMUNICATION
 TB: POWER
 EL: HEATING ELEMENT, PREASSURE SWITCH

AP: DRAIN PUMP
 EL: HEATING ELEMENT
 F: FILTER
 IV: INLET VALVE
 LL: DOOR LOCK
 MCU: MOTOR CONTROL UNIT

TB: MAIN SWITCH
 TG: TACHO GENERATOR
 NTC: THERMISTOR
 P: PRESSURE SWITCH
 TS: PRESSURE SENSOR

*A FUSE CONNECTION USA & CANADA
 Wires in all machines
 Internal connection
 Wires in some machines

This document must not be copied without our written permission, and the contents thereof must not be imparted to a third party without our prior written consent. Any violation of this policy will be prosecuted.

Pos.	Qty	Part No.	Name of item	Material
Material		Dens.Kg/dm3	Dimensions, Type, etc.	
Scale		Gen.tolerance	Description(ENG) CIRCUIT DIAGRAM WM25 CIM	
Designed by		Gen.tol.Angle	Description(SE) KOPPLINGSSCHEMA WM25 CIM	
Released by		Iss by Dept	Year	Week
		UT	03	33
		80 805 44		01
		ASKO CYLINDA		Rev Ind
				Replace
				8080544-00
				Project
				WM25

Timer diagram

Servicemanual WM25

Timer diagram, table explanation

	Option
	Factory settings

Action type	F	Fill action fills up to the specified level
	TF	Fills for selected time, if selected level is not reached within the time, continue to fill to selected level is reached
	D	Drain action, which pumps until specified level is reached + 30 seconds. If specified level is reached within time, skip the light blue steps
	T	Time action that executes level-control and motion as specified. Motor motion when water level exceeds. During refilling no motor motion
	H	Thermostop-step that heats up to selected temperature. The step will end when selected temperature is reached
	HD	Time controlled heat-step. Heats to selected temperature or to specified time elapses
	WT	The time in this step is depending of numbers of refills in the filling step
	TD	Identical to T-action except for the definition of the step-time. Specified step-time reduced with previous F-action or H-action
	S	Spin-action
	TO	Time out

Motor action	NF	Normal fill action: Clockwise 9 seconds on 6 seconds off, counterclockwise 9 seconds on 6 seconds off. 40rpm
	N	Normal action: Clockwise 12 seconds on 3 seconds off, counterclockwise 12 seconds on 3 seconds off. 49rpm
	G	Gentle action: Clockwise 3 seconds on 27 seconds off, counterclockwise 3 seconds on 27 seconds off. 49rpm
	SG	Super gentle action: Clockwise 3 seconds on 57 seconds off, counterclockwise 3 seconds on 57 seconds off. 49rpm
	SSG	Super super gentle action: Same as SG except motion, 40rpm
	G*	Pre-soak action: 1 minut off G-action, 10 minutes no motion

Inlet valves	Valve	Definition
	1	Pre-soak, pre-wash and rinses
	2	Main wash (cold water)
	3	Main wash (hot water)
	4	Final rinse (for rinse agent)

Level table	Fill-action	U-level/Volt	Definition
	P1	1,04	Safety: heater door opening
	P3	1,12	Drain level
	P4	1,58	Refill pre-soak and wool
	P5	1,84	Rinse level
	P6	2,32	Fill level pre-soak and wool
	P7	2,75	Reset level over-flow
	P8	3,32	Over-flow level
	P9	1,36	Normal wash level
	P11-P18	Refill pre-wash & main wash
	1)	-	If P3 not has been reached within 2', these steps will follow: • 3' no action • 1' trying to reach P3