

WASHER/DRYER COMBO TRAINING MANUAL



CAUTION!

**READ THIS MANUAL CAREFULLY
BEFORE DIAGNOSING OR SERVICING THIS PRODUCT.**



Customer Service (and Part Sales)	(800) 243-0000
Technical Support (and Part Sales)	(800) 243-0000
USA Website	us.lge.com
Customer Service Website	us.lgservice.com
B2B Service Website	aic.lgservice.com
LG CS Academy	lgcsacademy.com

Published September 2005 by LG Technical Support Service

WM3677COMBO (Washer/Dryer)

Contents	3
Safety Notices and Warnings	4
OVERVIEW	5
Introduction	5
Specifications	6
Serial Numbers	7
Features	8
INSTALLATION	12
Preparation	12
Connections	13
Water	13
Electrical	13
Drain	13
OPERATION	14
Control Panel	14
Program Chart	15
Dispenser	16
TROUBLESHOOTING	18
Test Mode	18
Checking Water Level Frequency	18
Test Flow Chart	19
Error Codes	20
Diagnosis and Check List	22
DISASSEMBLY and REPAIR	35
Control Panel	35
Main PWB	36
Dispenser	37
Noise Filter	38
Front Cabinet Cover	39
Door and Door Lock Switch	41
Motor	42
Damper	44
Tub Removal and Repair	45
Water Level Switch	50
Pumps (Drain and Circulating)	51
Water Heater and Thermistor	52
Removal of Foreign Objects Between Tub and Drum	52
Ball Sensor (Unbalance switch)	53
Dryer Repair	55
Main PC Board	57
WIRING DIAGRAM	58
EXPLODED VIEWS	59
PARTS LIST	63
	061130

IMPORTANT SAFETY NOTICE

The information in this training manual is intended for use by persons possessing an adequate background in electrical equipment, electronic devices, and mechanical systems. In any attempt to repair a major appliance, personal injury and property damage can result. The manufacturer or seller maintains no liability for the interpretation of this information, nor can it assume any liability in conjunction with its use. When servicing this product, under no circumstances should the original design be modified or altered without permission from LG Electronics. Unauthorized modifications will not only void the warranty, but may lead to property damage or user injury. If wires, screws, clips, straps, nuts, or washers used to complete a ground path are removed for service, they must be returned to their original positions and properly fastened.

CAUTION

To avoid personal injury, disconnect the power before servicing this product. If electrical power is required for diagnosis or test purposes, disconnect the power immediately after performing the necessary checks. Also be aware that many household appliances present a weight hazard. At least two people should be involved in the installation or servicing of such devices. Failure to consider the weight of an appliance could result in physical injury.

DO NOT allow children to play in the COMBO drum. While the door latch is designed to open by only pulling, the door can not be opened from the inside if the COMBO is turned on.

ESD NOTICE

Some of the electronic in appliances are electrostatic discharge (ESD) sensitive. ESD can weaken or damage the electronics in these appliances in a manner that renders them inoperative or reduces the time until their next failure. Connect an ESD wrist strap to a ground connection point or unpainted metal in the appliance. Alternatively, you can touch your finger repeatedly to a ground connection point or unpainted metal in the appliance. Before removing a replacement part from its package, touch the anti-static bag to a ground connection point or unpainted metal in the appliance. Handle the electronic control assembly by its edges only. When repackaging a failed electronic control assembly in an anti-static bag, observe these same precautions.

REGULATORY INFORMATION

This equipment has been tested and found to comply with the limits for a Class B digital device, pursuant to Part 15 of the FCC Rules. These limits are designed to provide reasonable protection against harmful interference when the equipment is operated in a residential installation. This equipment generates, uses, and can radiate radio frequency energy, and, if not installed and used in accordance with the instruction manual, may cause harmful interference to radio communications. However, there is no guarantee that interference will not occur in a particular installation. If this equipment does cause harmful interference to radio or television reception, which can be determined by turning the equipment off and on, the user is encouraged to try to correct the interference by one or more of the following measures: Reorient or relocate the receiving antenna; Increase the separation between the equipment and the receiver; Connect the equipment to an outlet on a different circuit than that to which the receiver is connected; or consult the dealer or an experienced radio/TV technician for help.

DISCLAIMER

Every effort has been made to create a training manual free from defects. In the event of corrections or updates, the most current manual will be available online via LG CS Academy. (See page 2.)

COMPLIANCE

The responsible party for this device's compliance is LG Electronics Alabama, Inc.; 201 James Record Road, Huntsville, AL, 35824.

INTRODUCTION

The 2005 lineup of LG Washers and Dryers includes the WM3677HW Combo. The control panel is on the front of the machine.

The COMBO is different in that it has all the features of our regular washing machine plus a condenser dryer built into the same housing. The washing machine functions like our standard washer. The condenser dryer works by condensing the moisture from the air circulating in the tub and expelling it via the drain hose.

In simplest terms, the dryer fan blows air across a 1,000-watt electric warming element and into the drum as the damp clothes tumble. Since warm air absorbs more moisture than cold air, this air stream absorbs moisture from the clothing as it passes through the drum. The moist air is then directed through the condensing duct, where a fine mist of cold water keeps the duct cool. The moisture in the air condenses and precipitates to the drain pump, where it is expelled through the drain hose. This dried air is then blown across the warming element and the cycle repeats itself.

Because the air is recirculated, no vent stack is necessary. This dryer takes longer than a conventional dryer but allows both washing and drying in one machine.

Drying time will likely be the most frequent complaint with the COMBO. When used as a washing machine, the combo will wash a large load. However, when used as a dryer, it will dry a load only half the size of the maximum wash load. This is because the clothes need more room to tumble to allow the air to flow through as they dry. Notice the dryers at the Laundromat[®] have twice the capacity of the washers. Similarly, the LG dryer (DLG5988 ~ 7.3 cu. ft.) has twice the capacity of the washer (WM2277HW ~ 3.7 cu. ft.). To use the drying function effectively, the user must fill the COMBO no more than half full of laundry to dry the load after washing. This is NOT a product defect.

The COMBO can be used as a washer only, or as a dryer only, in addition to being able to both wash and dry clothes in just one cycle. To wash clothes without drying, simply do not select a drying option. To dry clothes without washing, press the ON button and DO NOT SELECT a wash cycle; instead, press the DRY button to cycle through the dryer options. If you move the large control knob and select a wash cycle, turn the machine off and back on, and then choose a dry cycle as described above.

SPECIFICATIONS

COMBO	WM3766HW
Color	White, Black, Titanium
Wash Capacity	3.22 cu. ft.t3 (3.72 ft ³ IEC)
Dry Capacity	Max. 11 lbs. (8 kg)
Power Supply	120 VAC, 60 Hz, 5 Amps
Energy Consumption	Washing 280 W
	Drain Motor 80 W
	Fan Motor 25 W
	Dry Heater 1,200 W
Wash Heater	1,000 W
Drum Speed	Wash 42 rpm
	Spin 0~1,200 rpm
Water Pressure	4.5 - 145 psi (31 - 1000 kPa)
Motor	Direct Drive
Water Heater	Yes
Temperature Settings	5
Cycle Programs	7
Size	27" W x 31" D (51" with door open) x 39" (H)
Weight	201 lbs.
Delay Wash	9 hours
Wash Speed	46 rpm
Spin Speed (Max. RPM)	1,200 rpm
Water Circulation	Yes

SERIAL NUMBER IDENTIFICATION

The serial number is unique to each product. It gives information concerning the time and place of manufacture. The serial number is required to be paid for warranty service and to get the correct part in the event a running production change was made.

This chart will help you decode the serial number.

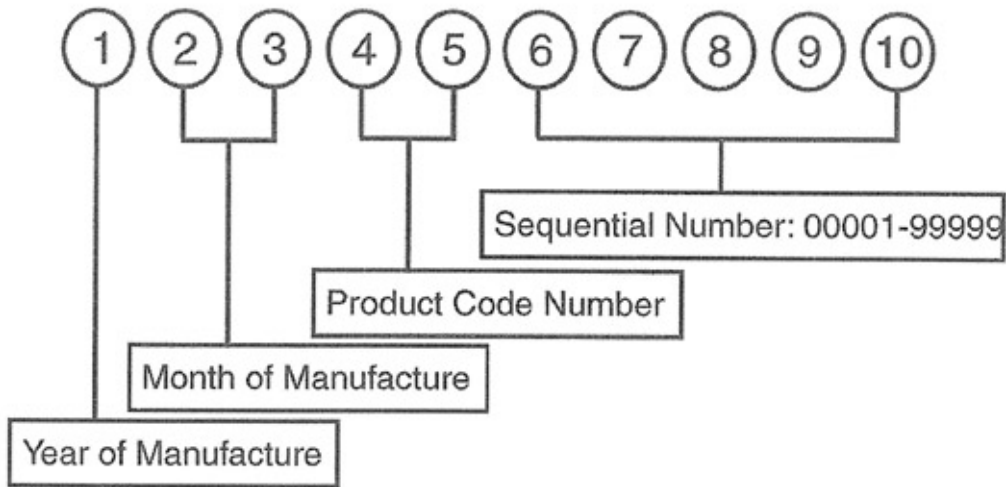

Example

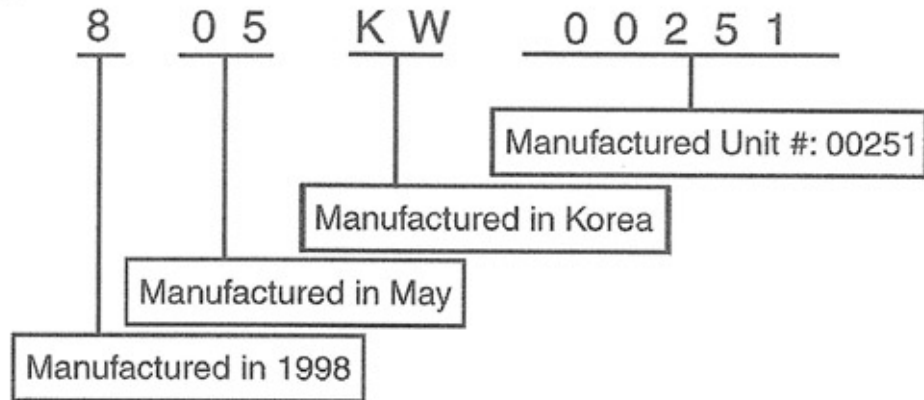

KEY FEATURES



DIRECT DRIVE MOTOR

The advanced brushless DC motor drives the drum directly without a belt or pulleys.

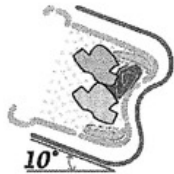

TILTED DRUM & LARGE DOOR

The 10° tilt and large door opening make it easy to load and unload the combo.



WATER CIRCULATION

The detergent solution in the drum is recirculated and sprayed repeatedly. The clothes are soaked more quickly during the wash cycle. Suds are eliminated by the water shower during the rinse cycle. The recirculation system uses water and detergent more efficiently.

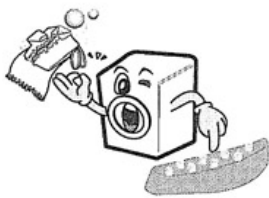

ROLLER JETS

The baffles in the drum include roller balls to enhance washing performance and reduce wear on clothing. The jets lift water and drizzle it throughout the wash load for better fabric care.

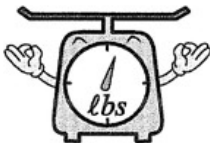

AUTOMATIC LOAD DETECTION

The COMBO automatically detects the size of the wash load and optimizes the washing performance via fuzzy logic.

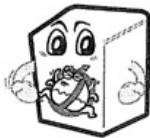

BUILT-IN HEATER

The internal heater automatically heats the water to the optimum temperature on selected cycles.



CHILD LOCK

This feature keeps the kids from pressing buttons and changing the settings during operation.

FUZZY LOGIC

To get the best washing performance, the user selects one of the standard cycles and sensors in the COMBO make an infinitely variable number of adjustments as the cycle progresses. Adjustments are made for load size, incoming water temperature, soil level, rinses required, and other variables.

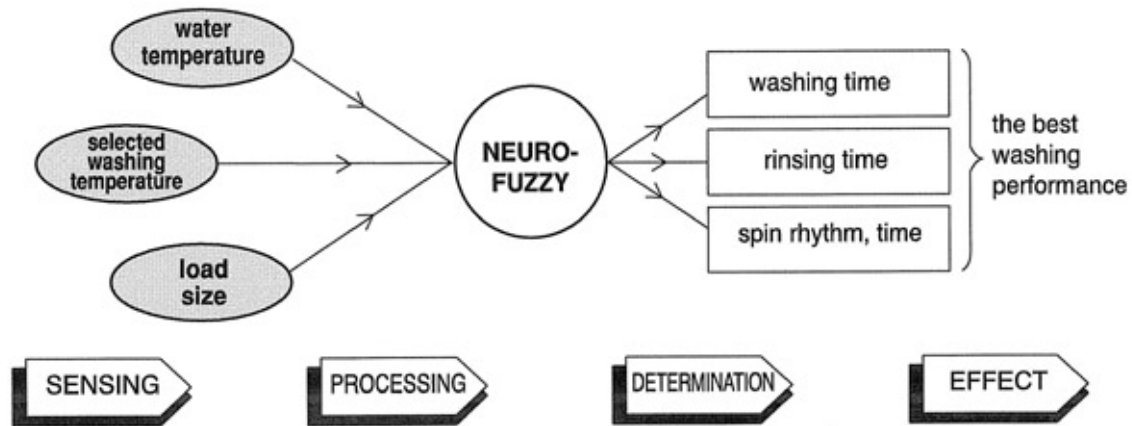

DOOR LOCK

The door has an automatic, electrically operated lock system. When the machine is off or paused, the door can be opened by pulling it. When the machine is operating, the electric latch keeps the door closed.

The door cannot be opened:

- When the COMBO is operating
- When the power failed or the washer is unplugged (until the capacitor discharges and releases the lock)
- When the DOOR LOCK light is on
- When the drum is still turning

DOOR LOCKED LAMP

The DOOR LOCK lamp lights:

- When the COMBO is operating
- When the water level sensor frequency is lower than 22.9 kHz
- When the temperature inside the tub is over 45° C (113°F)

WATER CIRCULATION

The recirculation pump circulates the water during most of the cycle. During the WASH cycle, it runs continuously for 3 minutes and then intermittently throughout the cycle. During the RINSE cycle, it runs continuously as soon as the appropriate amount of rinse water has been added. This recirculated water enters the drum at the top of the door at a small shower head. This spray not only keeps the window and gasket clean, it allows the clothes to be soaked with detergent or rinse water more quickly and can be used to control an oversudsing event.

PARTS IDENTIFICATION

(Front of COMBO)

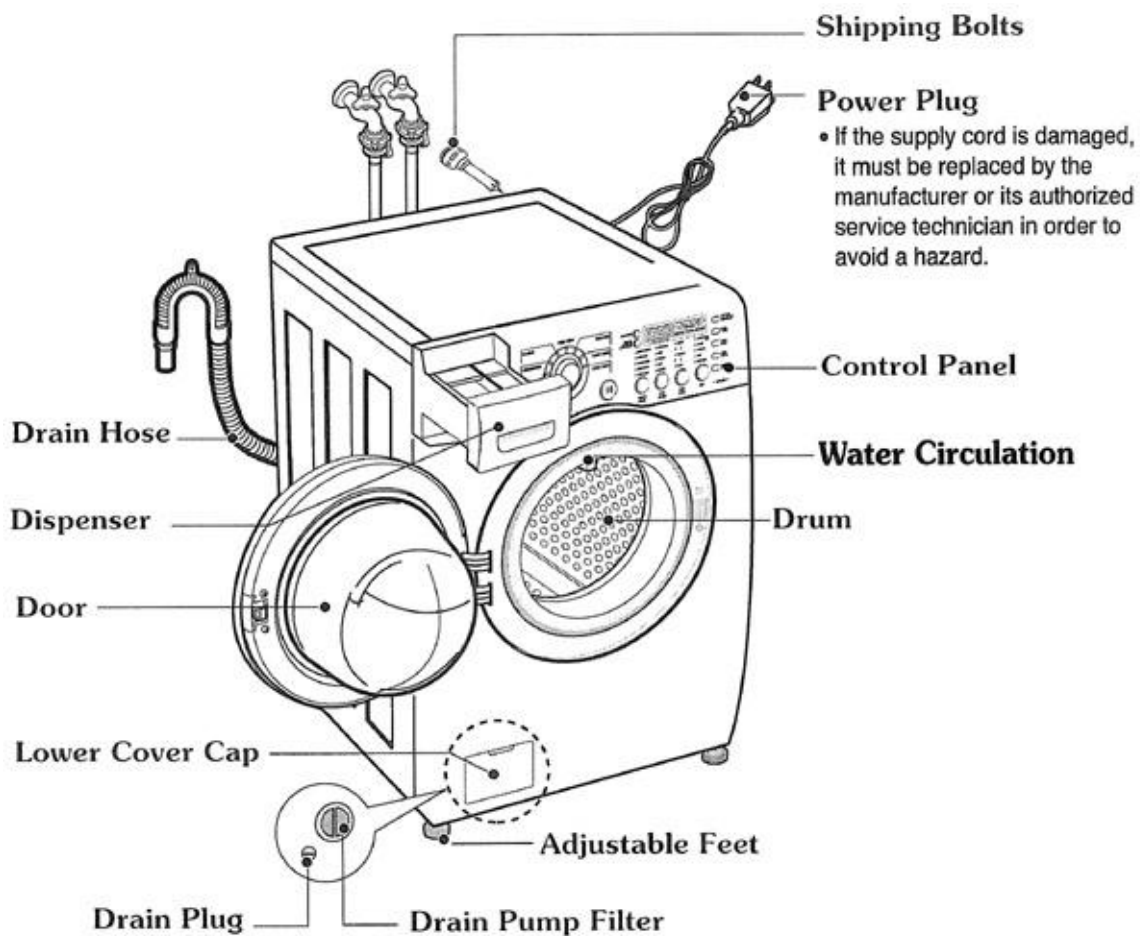

(Back of COMBO)

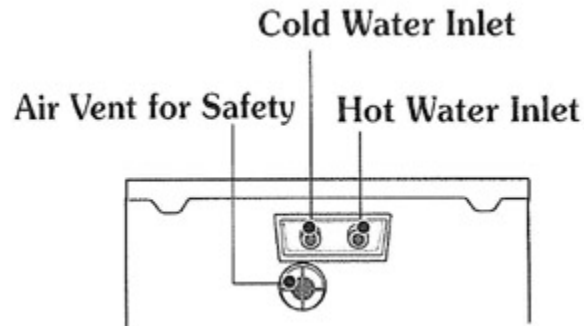

The air vent must be left open and clear at all times. If the combo is installed in a closet or closed laundry alcove, there must be sufficient clearance and ventilation. The closet should have a full louvered door with at least 800 square inches of open area for ventilation.

The COMBO requires a space of at least 1 inch between the wall and the machine on each side and at least 4 inches between the back of the washer and the wall. Additional space may be needed for servicing.

ACCESSORIES

The COMBO comes with the two input hoses. The blue stripe is for cold water and the red stripe is for hot water. While the hoses are mechanically identical, it is critical to the performance of the COMBO to have the hot and cold hoses connected correctly.

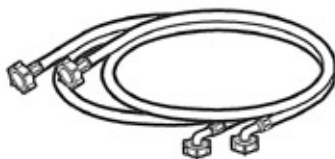

Hot/Cold (1 each)
Hose



Wrench



Tie strap (Option)
to secure drain hose to standpipe,
inlet hose, or laundry tub

The wrench is used to remove (and replace) the shipping bolts and to adjust the leveling feet. Be sure to leave it and encourage the customer to retain the wrench, the four shipping bolts, and the manual in a safe place in the event the washer requires service or the customer moves.

The shipping bolts **MUST BE REMOVED** before operating the COMBO.

INSTALLATION

REMOVE THE SHIPPING BOLTS.

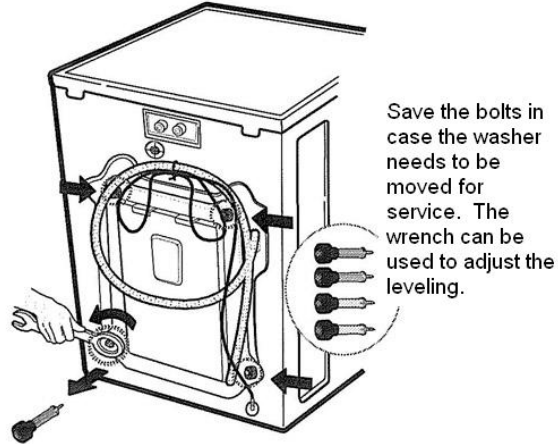

INSTALL THE COMBO ON A FIRM, FLAT SURFACE.

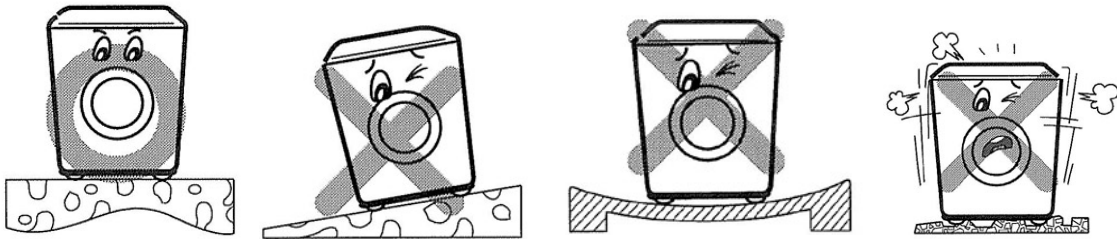

ADJUST THE FEET TO BE LEVEL.

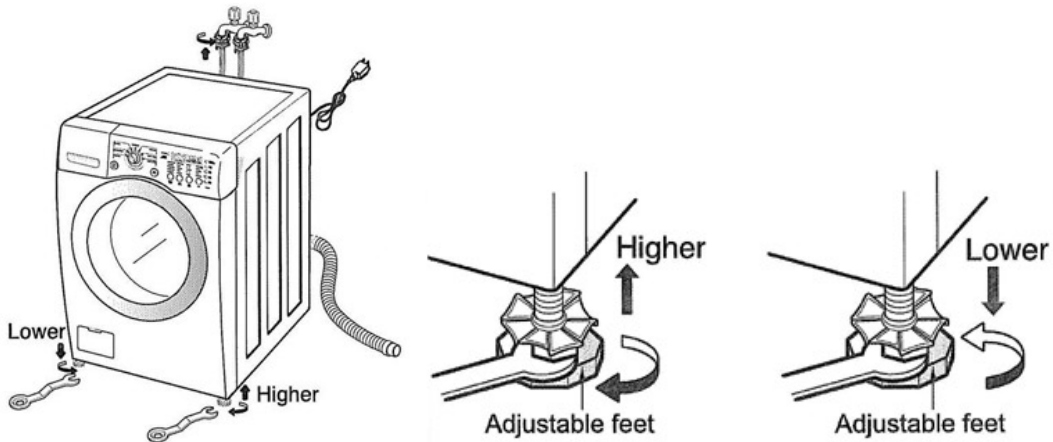

CONNECTIONS

WATER

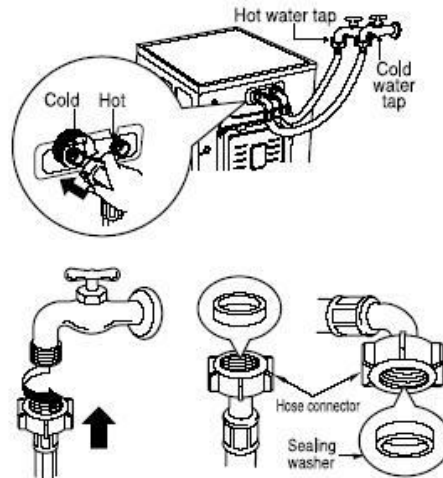

Be sure the rubber washer is inside the hose end. Attach the hoses to the COMBO (red is HOT, blue is COLD). Tighten them firmly but don't strip the plastic threads on the washer connections.

DRAIN

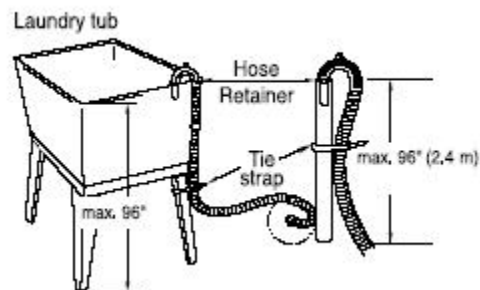

The drain pipe should be firmly attached to the standpipe or the laundry tub or sink where it drains. The pump has sufficient power to cause the pipe to move around when the water is expelled. The pump can lift the drain water a maximum of 96 inches, but there is no minimum height requirement. The hose can lay flat into a floor drain as long as the end of it is not submerged.

ELECTRICAL

The COMBO requires 120 VAC, 60 Hz., on a dedicated 20-amp circuit.

DETERGENT DISPENSER



The dispenser drawer is a multi-chambered reservoir that allows the user to add all the appropriate laundry additives before starting the cycle. It has a place for pre-wash detergent, main wash detergent, fabric softener, and bleach. Powdered or liquid detergents may be used, but softener and bleach must be liquids. Detergents should carry the **HE** designation. Do not use regular detergents in the combo or oversudsing will occur.

The top of the dispenser box is shown here.

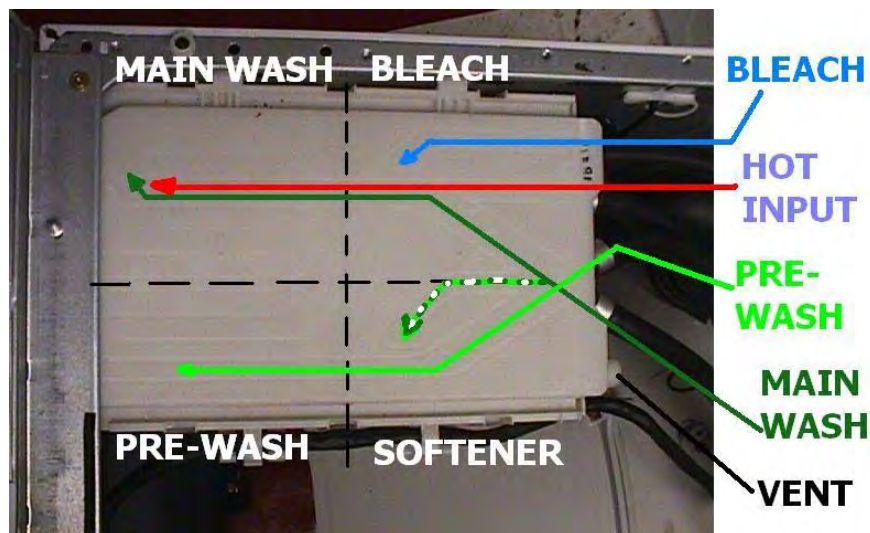

The dispenser works by using various solenoids to apply water to different compartments. The liquid products are dispensed from a siphon box. As the appropriate chamber is flooded, the box fills and the water flushes the laundry

product into the tub. It is mixed with water before contacting the laundry to prevent spotting or damaging the fabric.

Notice that the pre-wash and main wash fill tubes enter the dispenser at an angle. If one or the other fill valve is opened, the water goes into the appropriate detergent compartment. However, if they are opened simultaneously, the streams deflect and dispense the softener. Some water may run through the main and pre-wash compartments, but since the detergent has already been dispensed in an earlier part of the cycle, this is of no consequence.

If liquid detergent is added to the pre-wash box, it will run immediately into the tub. This doesn't affect the operation of the cycle. To use liquid detergent in the main wash, place the detergent siphon box in the main wash compartment. Otherwise, the main wash liquid detergent will run into the tub along with the pre-wash detergent, causing oversudsing in the pre-wash and no cleaning in the main wash.

The siphon boxes are designed to hold a liquid laundry product until the appropriate time for dispensing into the load. When the box fills with water, it begins to discharge its contents into the washer fill stream. Once the siphon action has started, it will continue until the siphon box has emptied itself. Use only regular viscosity bleaches and softeners; the ultra versions are usually thicker and do not dispense well, if at all.



By the end of any cycle, water will have run through all of the dispenser compartments, preventing any cross-contamination of subsequent loads.

TEST MODE

The COMBO must be empty and off to enter TEST MODE.

1. Press and hold the SPIN SPEED and SOIL LEVEL buttons.
2. Press the POWER button. The buzzer will sound twice.
3. Press START/PAUSE repeatedly to cycle through the test modes.

Number of times the Start/Pause button is pressed	Check Point	Display Status
None	Turns on all lamps and locks the door.	
1 time	Tumble clockwise.	rpm (40~50)
2 times	Low speed Spin.	rpm x 10 (60±)
3 times	High speed Spin.	rpm x 10 (110±)
4 times	Inlet valve for prewash turns on.	Water level frequency (25~65)
5 times	Inlet valve for main wash turns on.	Water level frequency (25~65)
6 times	Inlet valve for hot water turns on.	Water level frequency (25~65)
7 times	Inlet valve for bleach turns on.	Water level frequency (25~65)
8 times	Inlet valve for dry turns on.	Water level frequency (25~65)
9 times	Tumble counterclockwise.	rpm (40~50)
10 times	Heater turns on for 3 sec.	Water temperature
11 times	Circulation pump turns on.	Water level frequency (25~65)
12 times	Drain pump turns on.	Water level frequency (25~65)
13 times	Dry fan & motor turns on.	Water level frequency (25~65)
14 times	Power off and unlock the door.	Turn off all lamps.

HOW TO CHECK THE WATER LEVEL FREQUENCY

* Press the SPIN SPEED and SOIL LEVEL buttons simultaneously.

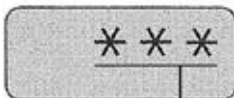

● The digits indicate the water level frequency (x.1 kHz).

So, a display indicating 241 = a Water level frequency of 241 x.1 kHz
= 24.1 kHz



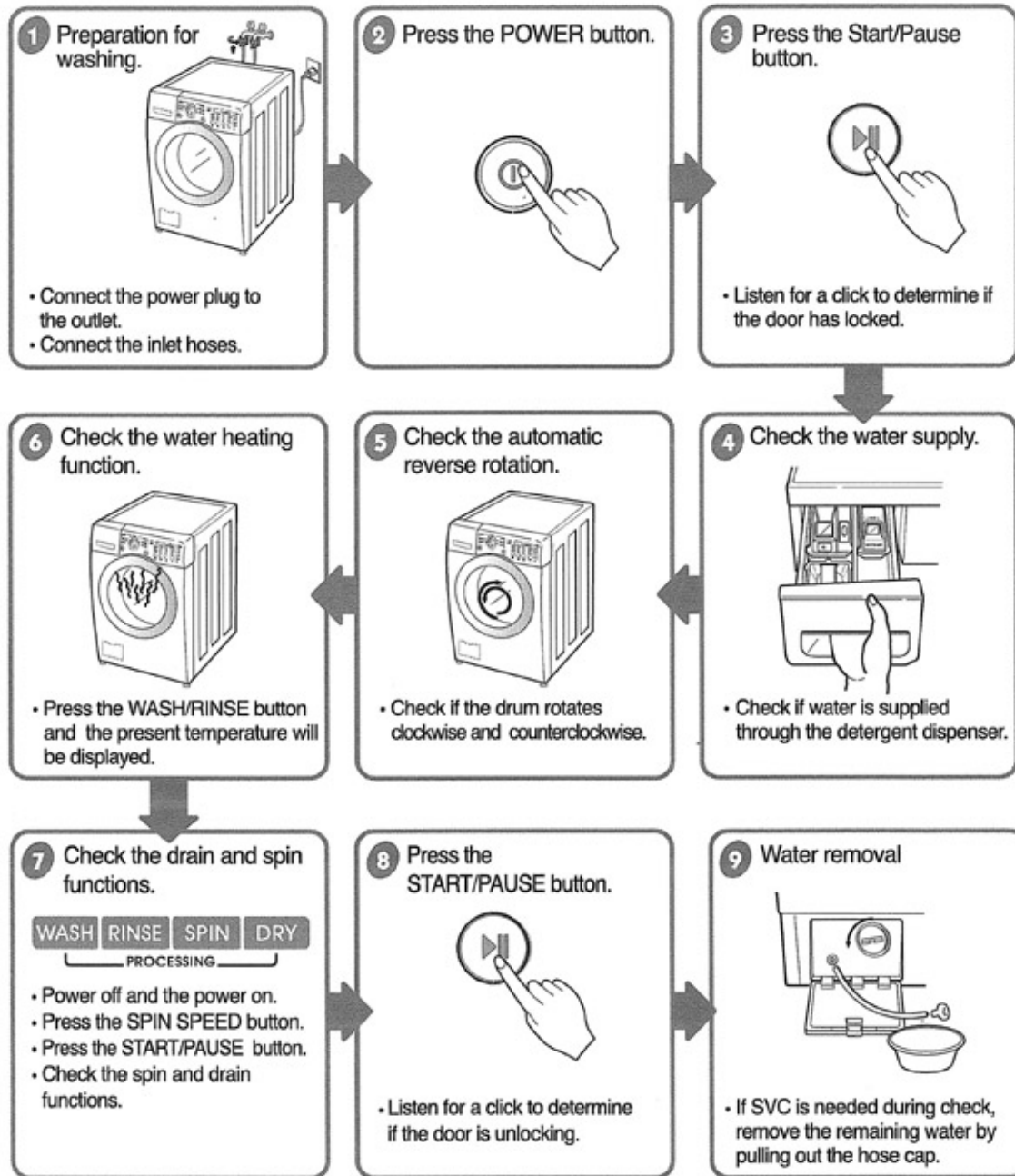

TEST OPERATION

Always test the COMBO for proper operation after installation and after any repairs or adjustments are made. Use this flow chart.



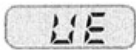

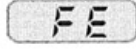
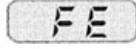
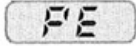
ERROR CODES

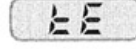



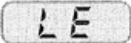

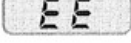
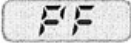
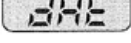
- If you press START/PAUSE when an error code is displayed, the error code will disappear and the COMBO will go into PAUSE status.
(Exception: **PE**)
- In a case of **PE**, **tE**, or **dE**, if the error is not resolved within 20 seconds, the COMBO will power OFF.
- In the case of any other error code, if the error is not resolved within 4 minutes, the COMBO will power OFF.
- In the case of **FE**, the COMBO will not power off.

	ERROR	SYMPTOM	CAUSE
1	WATER INLET ERROR		<ul style="list-style-type: none"> • Correct water level (246) is not reached within 8 minutes after water is supplied or it does not reach the preset water level within 25 minutes.
2	IMBALANCE ERROR		<ul style="list-style-type: none"> • The load is too small. • The appliance is tilted. • Laundry is gathered to one side. • Non distributable things are put into the drum.
3	DRAIN ERROR		<ul style="list-style-type: none"> • Not fully drained within 10 minutes.
4	OVER FLOW ERROR		<ul style="list-style-type: none"> • Water is overflowing (water level frequency is over 213). ※ If  is displayed, the drain pump will operate to drain the water automatically.
5	PRESSURE SENSOR ERROR		<ul style="list-style-type: none"> • The SENSOR SWITCH ASSEMBLY is out of order.
6	DOOR OPEN ERROR		<ul style="list-style-type: none"> • Door not all the way closed. • Loose electrical connections at Door switch and PWB Assembly. • The DOOR SWITCH ASSEMBLY is out of order.
7	HEATING ERROR		<ul style="list-style-type: none"> • The THERMISTOR is out order.

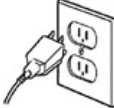
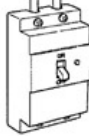
continued on next page

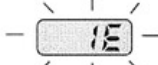





	ERROR	SYMPTOM	CAUSE
8	OVER CURRENT ERROR		<ul style="list-style-type: none"> • MAIN PWB ASSEMBLY is out of order. • Winding in the STATOR ASSEMBLY is short-circuited.
9	LOCKED MOTOR ERROR		<ul style="list-style-type: none"> • The connector (3-pin, male, white) in the MOTOR HARNESS is not connected to the connector (3-pin, female, white) of STATOR ASSEMBLY. • The electric contact between the connectors (3-pin, male, white) in the MOTOR HARNESS and 4-pin, female, white connector in the MAIN PWB ASSEMBLY is bad or unstable. • The MOTOR HARNESS between the STATOR ASSEMBLY and MAIN PWB ASSEMBLY is cut (open circuited). • The hall sensor is out of order/defective.
10	BALL SENSOR ERROR		<ul style="list-style-type: none"> • Loose Ball Sensor Connector. • Ball Sensor is out of order. ※ Displayed only when the START/PAUSE button is first pressed in the QC Test Mode.
11	EEPROM ERROR		<ul style="list-style-type: none"> • EEPROM is out of order. ※ Displayed only when the START/PAUSE button is first pressed in the QC Test Mode.
12	POWER FAILURE		<ul style="list-style-type: none"> • The washer experienced a power failure.
13	DRY HEATER ERROR		<ul style="list-style-type: none"> • The Dry Heater is out of order. <ul style="list-style-type: none"> - Replace the Dry Heater • The connector of the Dry Heater is not connected properly to the connector in the main PWB ASSEMBLY. <ul style="list-style-type: none"> - Reconnect or repair the connector. • The Dry Fan Motor is out of order. <ul style="list-style-type: none"> - Replace the fan motor.

DIAGNOSIS and CHECK LIST (Abnormal Operation)

SYMPTOM	GUIDE FOR SERVICE CALL
<p>No power</p>	<div style="display: flex; justify-content: space-between;"> <div style="width: 60%;"> <p>Is the power plug connected firmly to 120 V AC outlet?</p> <p style="text-align: center;">↓ YES ↓</p> <p>Power failure? or Breaker opened? Is the outlet controlled by a switch?</p> <p style="text-align: center;">↓ NO ↓</p> <p style="text-align: center;">Visit to service.</p> </div> <div style="width: 35%; text-align: center;">   </div> </div>
<p>Water inlet trouble</p> 	<div style="display: flex; justify-content: space-between;"> <div style="width: 60%;"> <p>Is  displayed?</p> <p style="text-align: center;">↓ YES ↓</p> <p>Is the tap opened?</p> <p style="text-align: center;">↓ YES ↓</p> <p>Is the tap frozen?</p> <p style="text-align: center;">↓ NO ↓</p> <p>Is the water supply shut-off?</p> <p style="text-align: center;">↓ NO ↓</p> <p>Is filter in the inlet valve clogged with foreign material?</p> <p style="text-align: center;">↓ NO ↓</p> <p style="text-align: center;">Visit to service.</p> </div> <div style="width: 35%; text-align: center;">     <div style="border: 1px solid black; padding: 5px; margin-top: 10px;"> <p style="text-align: center;">Clean the filter of inlet valve</p>  </div> </div> </div>

continued on next page

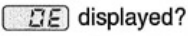
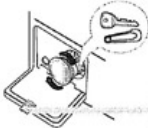
DIAGNOSIS and CHECK LIST (Abnormal Operation, continued)

SYMPTOM	GUIDE FOR SERVICE CALL
<p>Door error</p> 	<p>Started with door opened? YES → </p> <p>NO ↓</p> <p>Was the load too large? YES → Avoid overloading.</p> <p>NO ↓</p> <p>Clicking sound is heard once or twice, when the START/PAUSE button is pressed to start the cycle?</p> <p>NO ↓</p> <p>Visit to service.</p> <p>Check if the door switch is OK.</p> <p>Close the door. </p>
<p>Drain trouble</p> 	<p>Is  displayed? YES ↓</p> <p>Is the drain pump filter clogged with foreign material such as pins, coins, etc? YES → Clean up the filter. </p> <p>NO ↓</p> <p>Is the drain hose frozen, kinked, or crushed? NO ↓</p> <p>Visit to service. </p>

continued on next page

DIAGNOSIS and CHECK LIST (Abnormal Operation, continued)

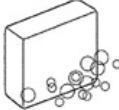
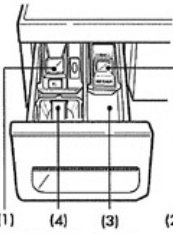
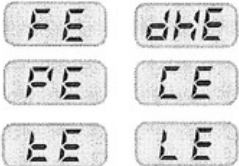
SYMPTOM	GUIDE FOR SERVICE CALL
<p>Suds overflow from the appliance. (In this condition, wash and spin do not operate normally)</p>	<div style="display: flex; justify-content: space-between;"> <div style="width: 60%;"> <p>Is a low-sudsing detergent used?</p> <p style="text-align: center;">↓ YES ↓</p> <p>Is the proper amount of detergent used as recommended?</p> <p style="text-align: center;">↓ YES ↓</p> <p>Recommend to reduce the amount of detergent.</p> <ul style="list-style-type: none"> * This appliance has an automatic suds sensing function which prevents overflow. * When excessive suds are sensed, the suds removing implementations such as drain, water input, pause will operate, without rotating the drum. </div> <div style="width: 35%; text-align: center;">  <p>LOW-SUDSING</p> </div> </div>
<p>Liquid laundry products do not flow in.</p>	<div style="display: flex; justify-content: space-between;"> <div style="width: 60%;"> <p>Is liquid laundry product put in the correct compartment of the dispenser?</p> <p style="text-align: center;">↓ YES ↓</p> <p>Is the cap clogged?</p> <p style="text-align: center;">↓ YES ↓</p> <p>Explain proper use of liquid laundry products.</p> <p>Clean the compartment.</p> </div> <div style="width: 35%; text-align: center;">  <p>(1) Liquid chlorine Bleach Compartment (2) Liquid fabric Softener Compartment (3) Prewash Compartment (4) Main Wash Compartment</p> </div> </div>
	<p style="text-align: center;">Visit to service.</p>

FAULT DIAGNOSIS and TROUBLESHOOTING

NO POWER

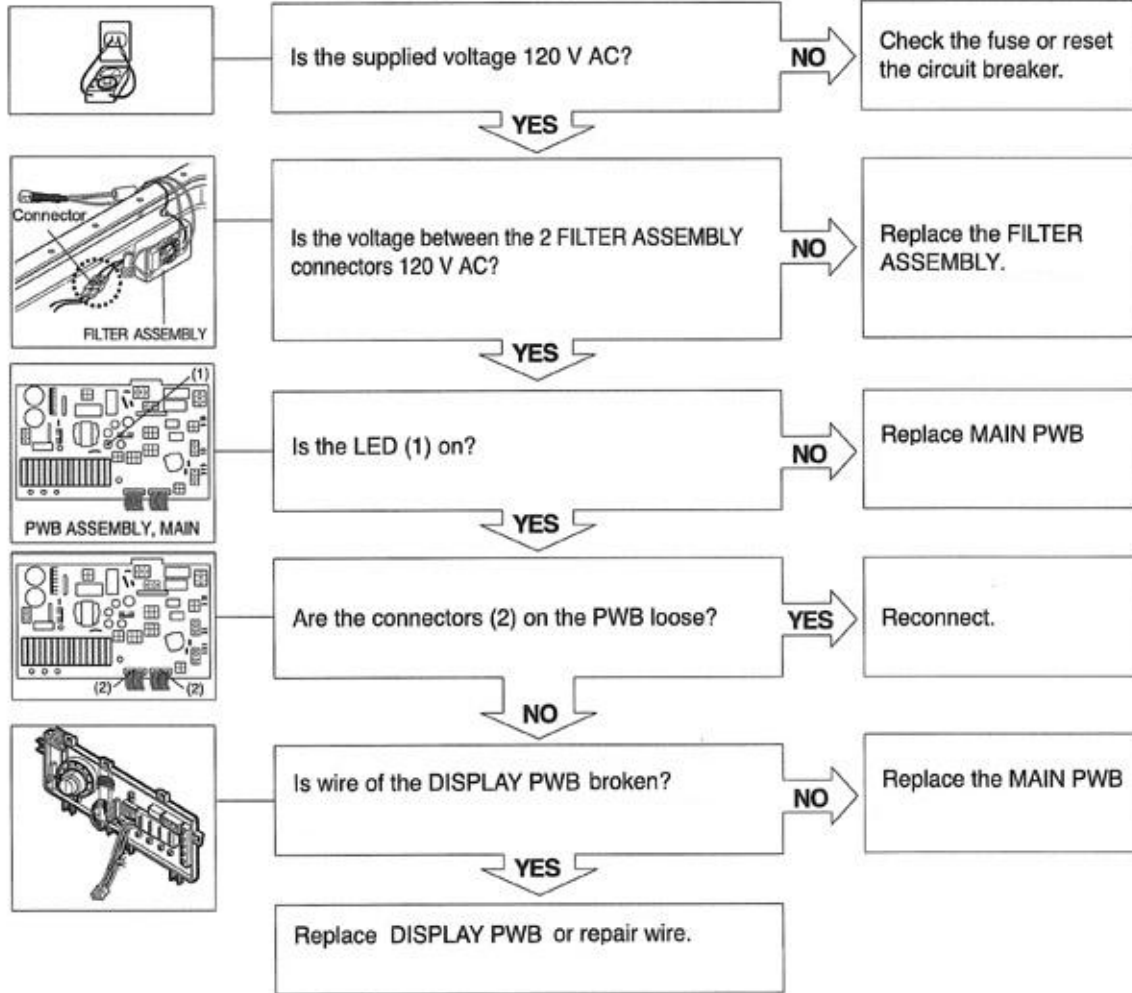

VIBRATION and SPIN NOISE

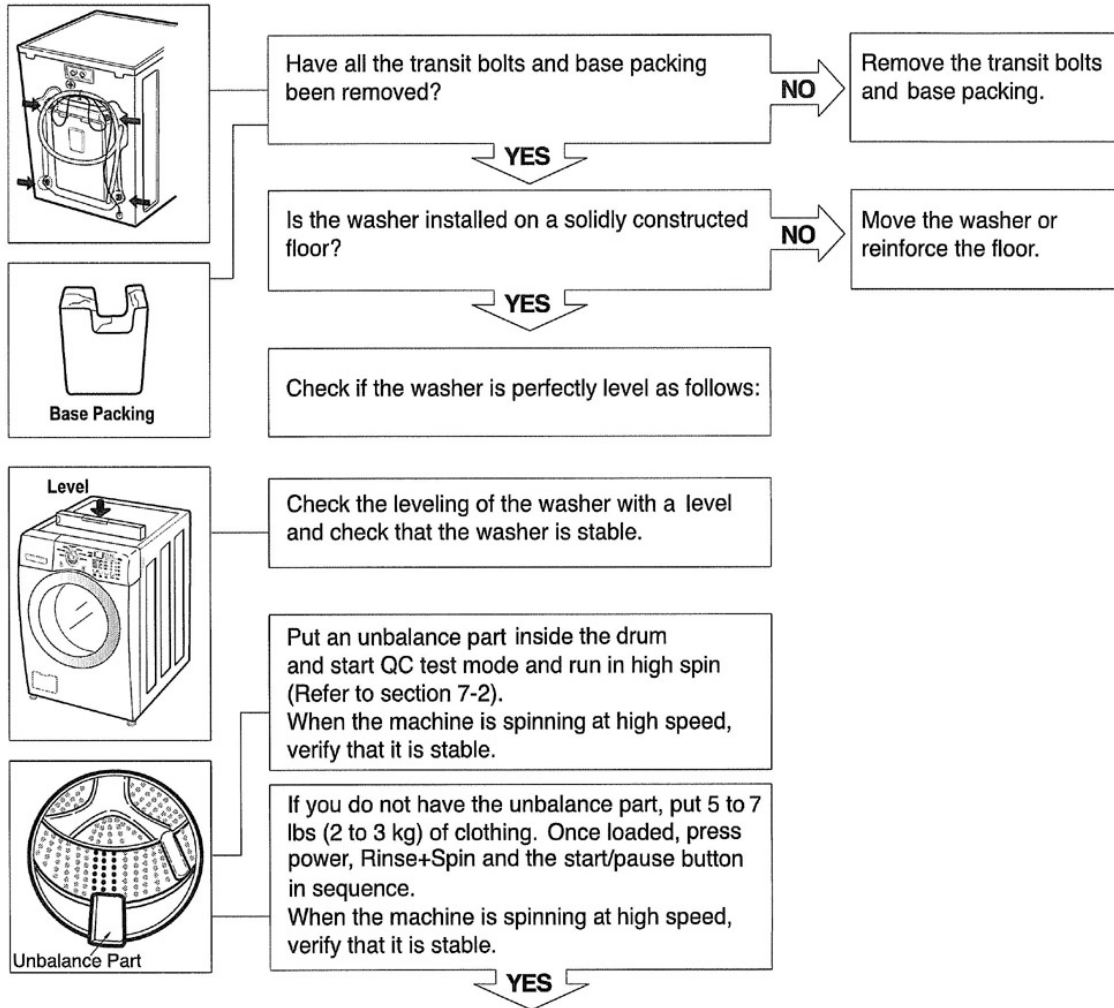

NO WATER SUPPLY

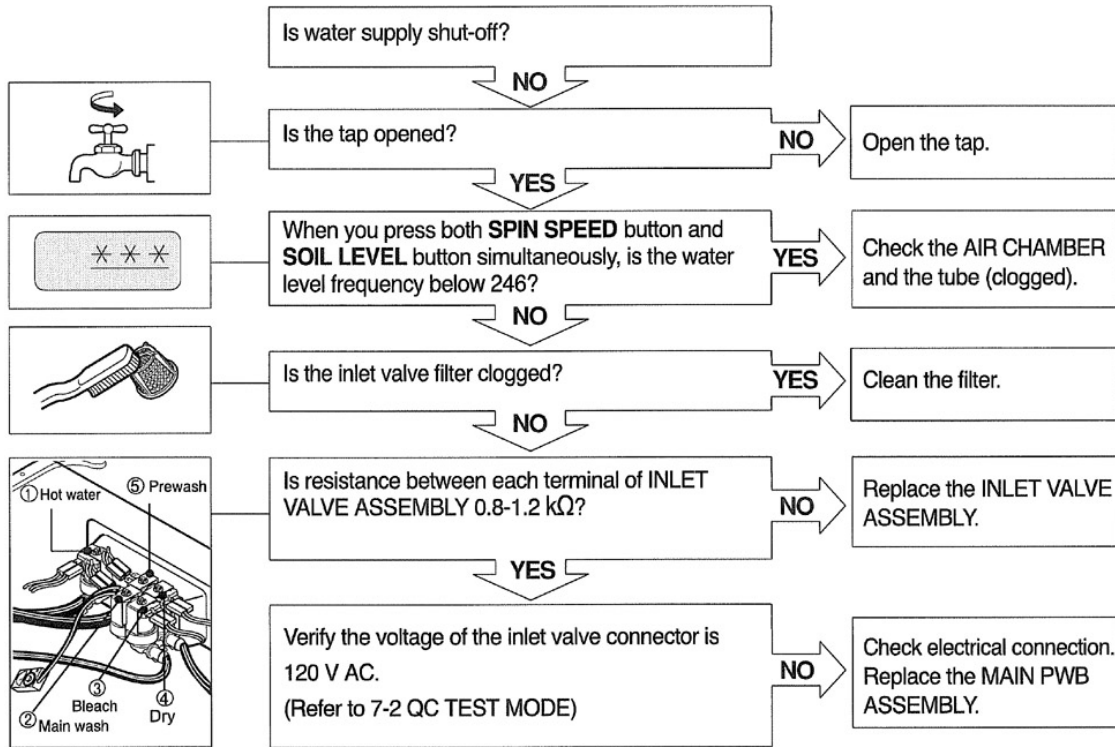

DETERGENT DOES NOT DISPENSE

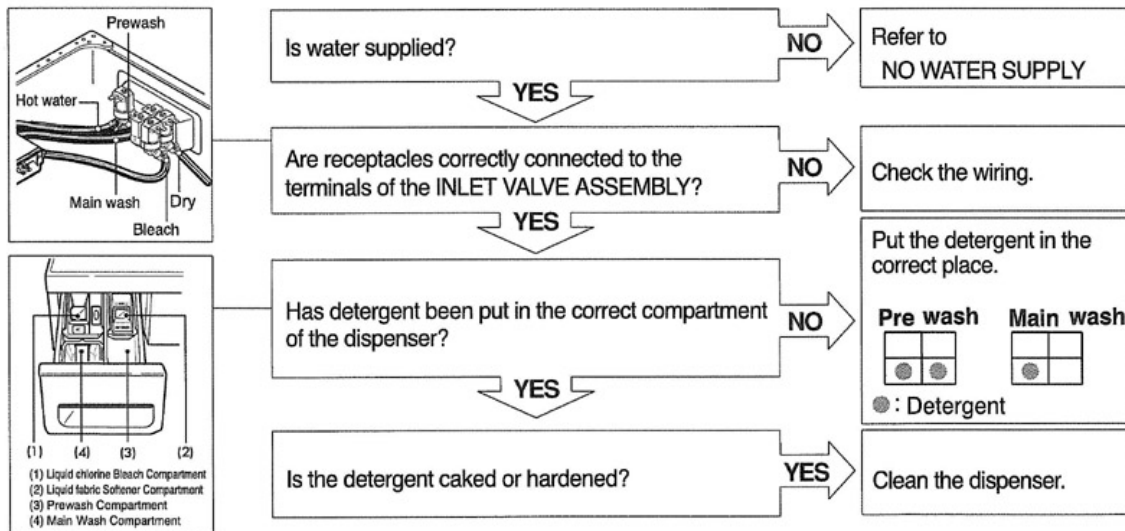

LIQUID DETERGENT/BLEACH/SOFTENER DO NOT DISPENSE

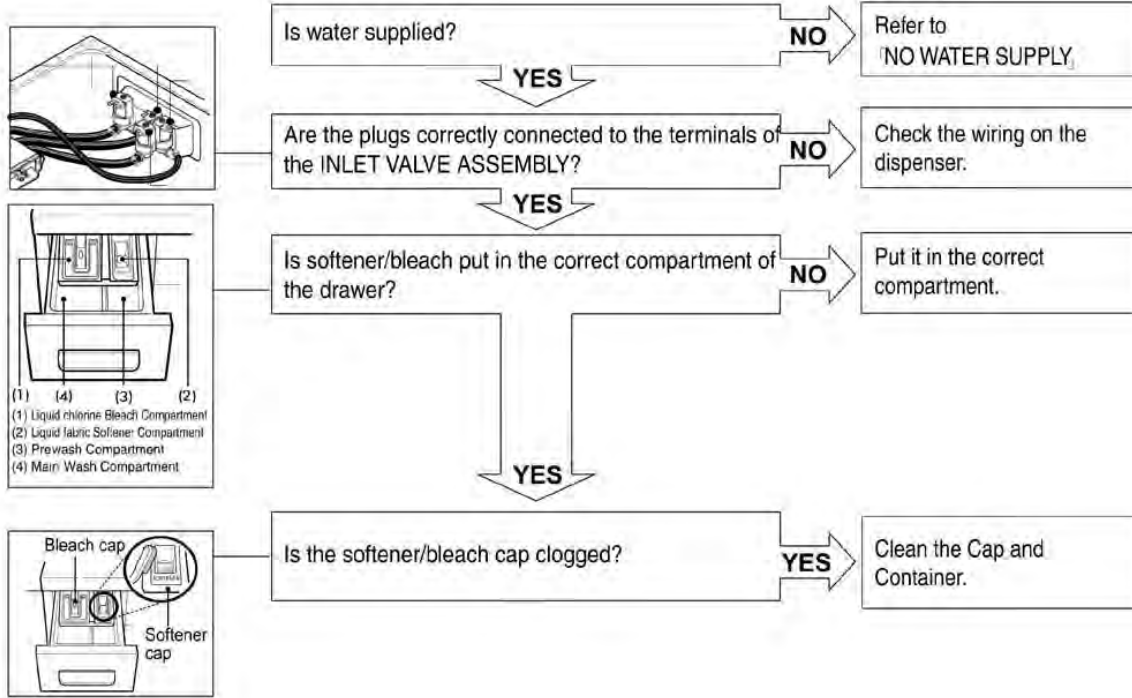

ABNORMAL SOUND

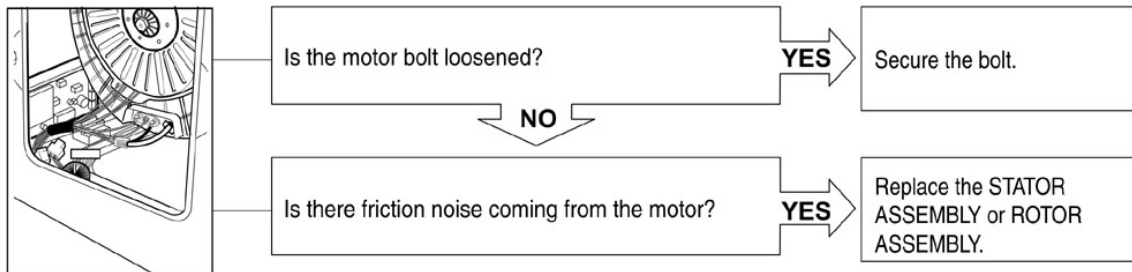

HEATING WITHOUT WATER

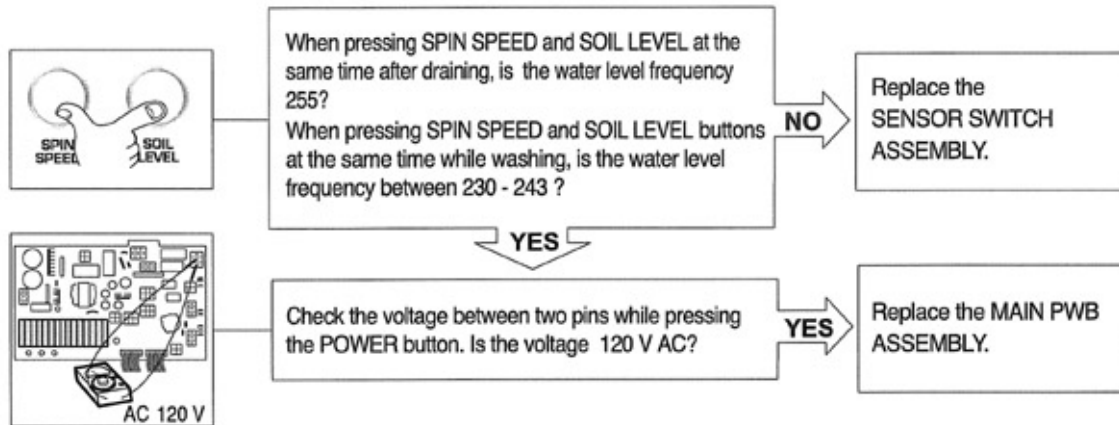

DRAIN MALFUNCTION

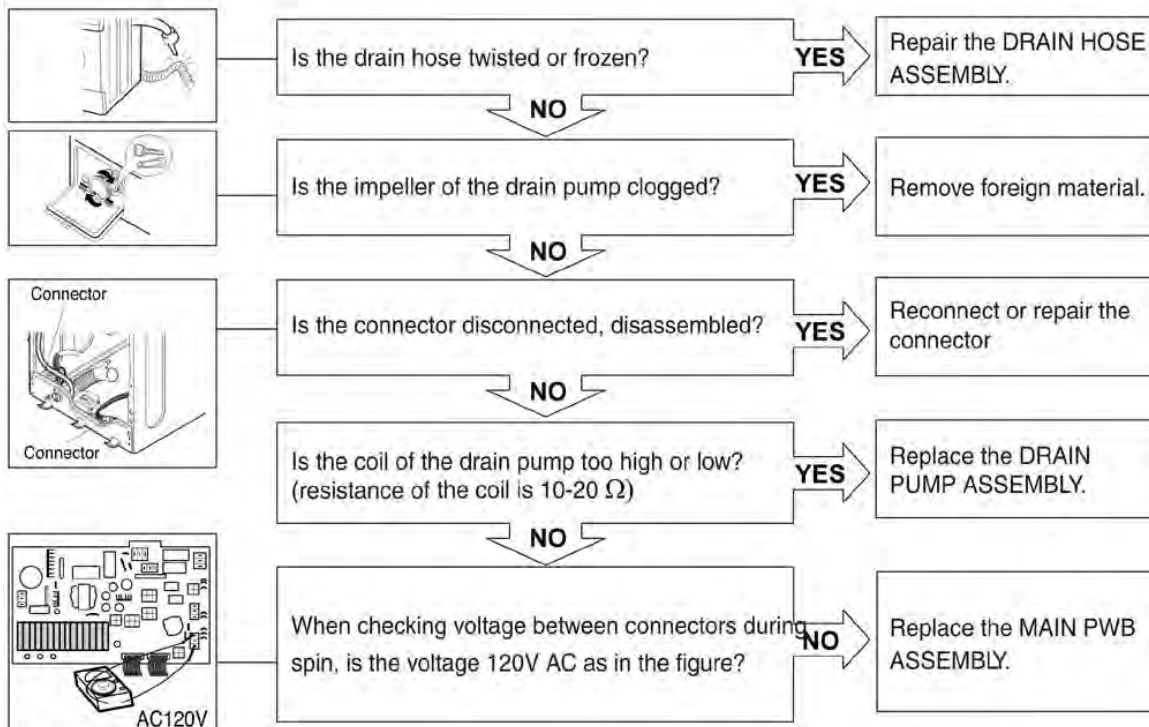

WASH HEATER MALFUNCTION

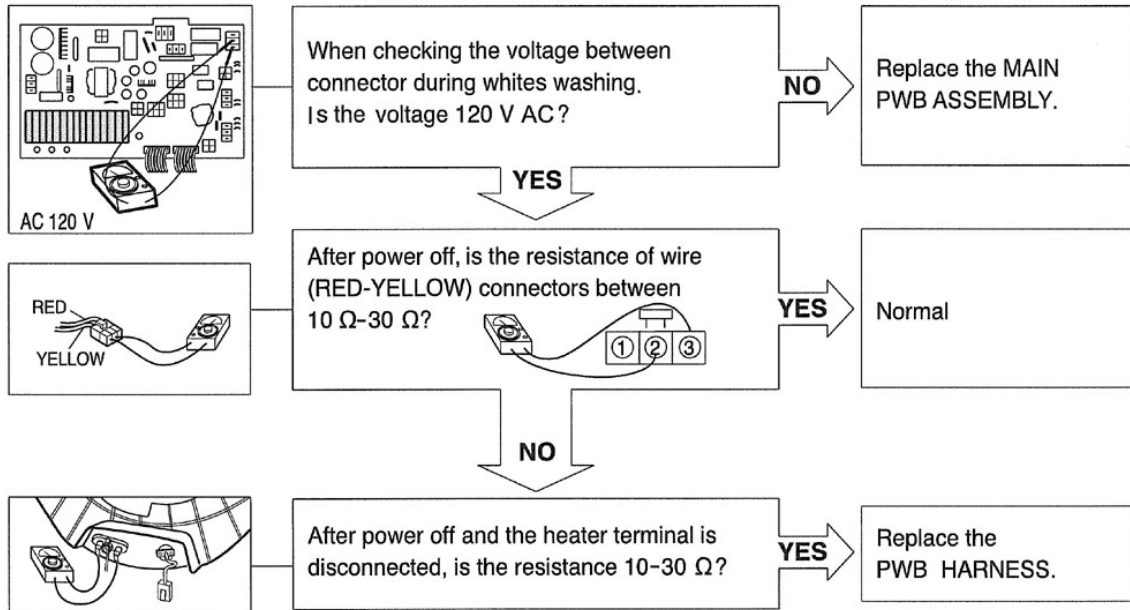

OVERHEATING WATER (Above Set Temperature)

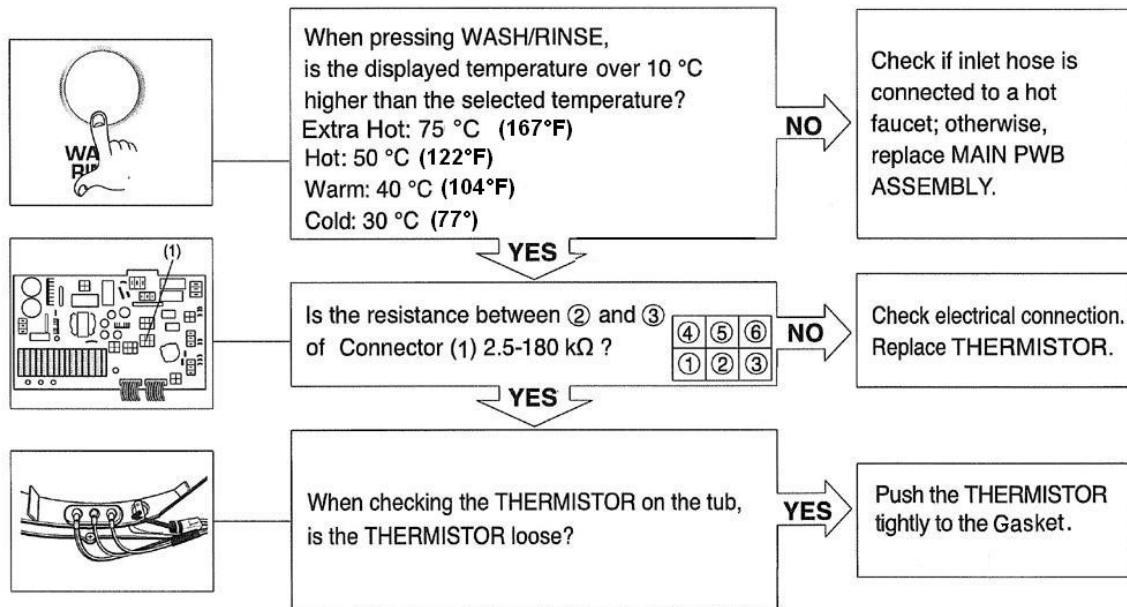

NO CIRCULATION

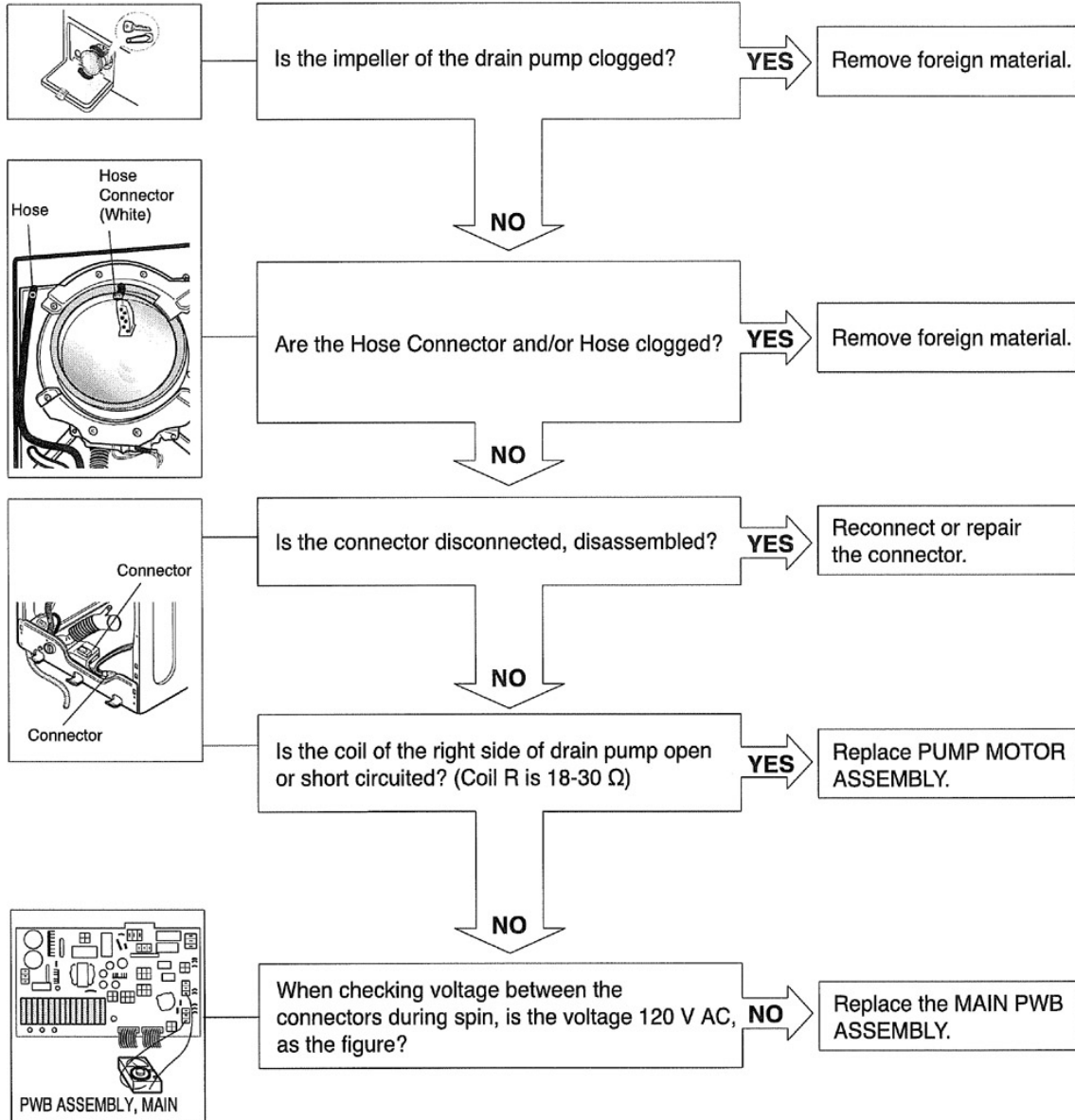

SPIN MALFUNCTION

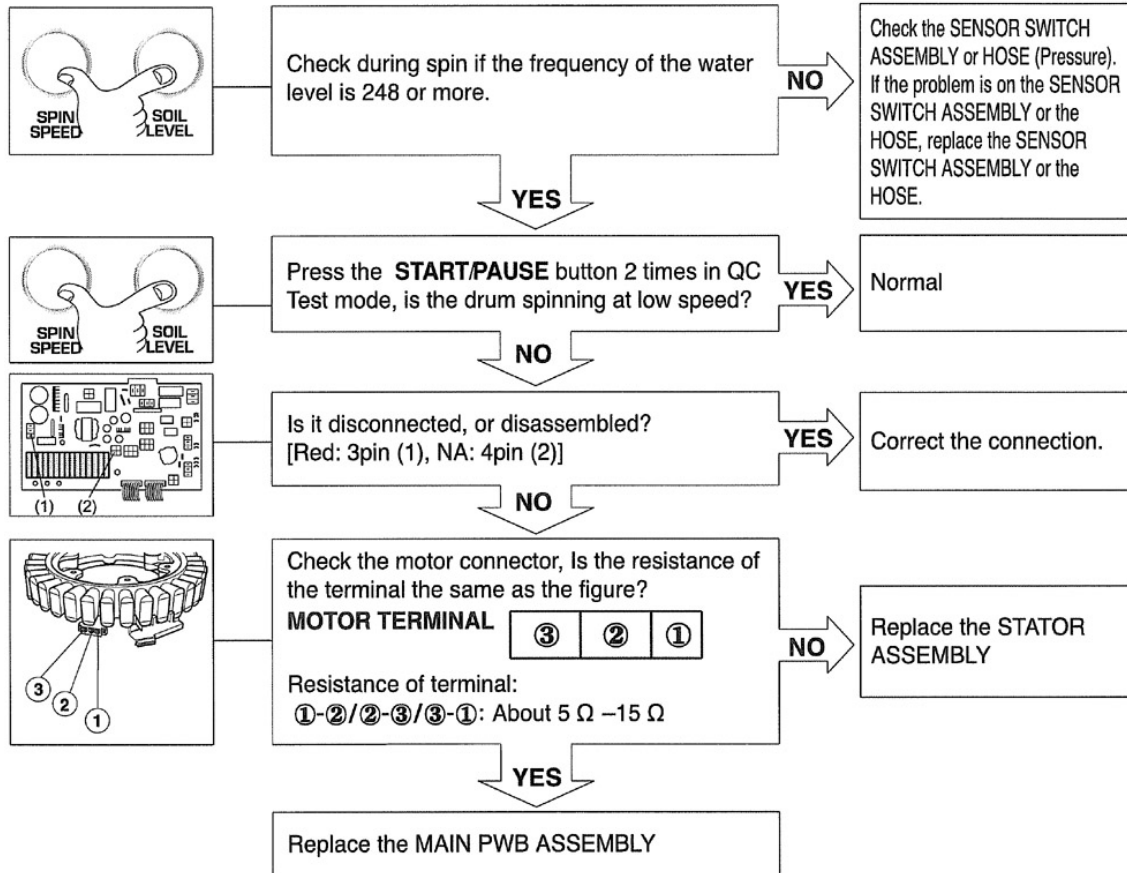

dE ERROR CODE

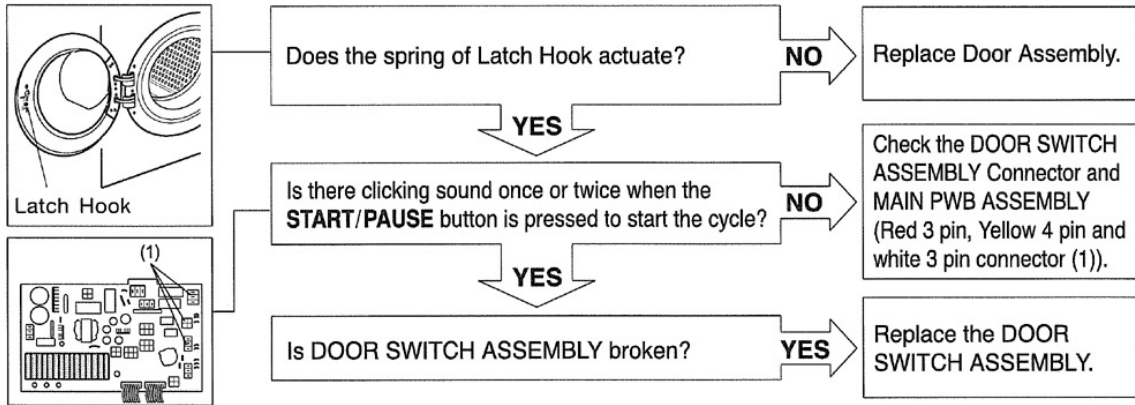

dHE ERROR CODE

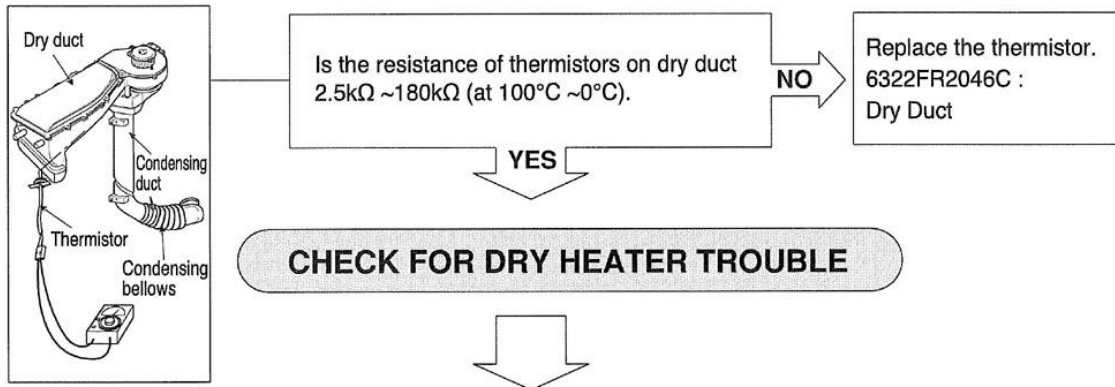

DRYER FAN MALFUNCTION

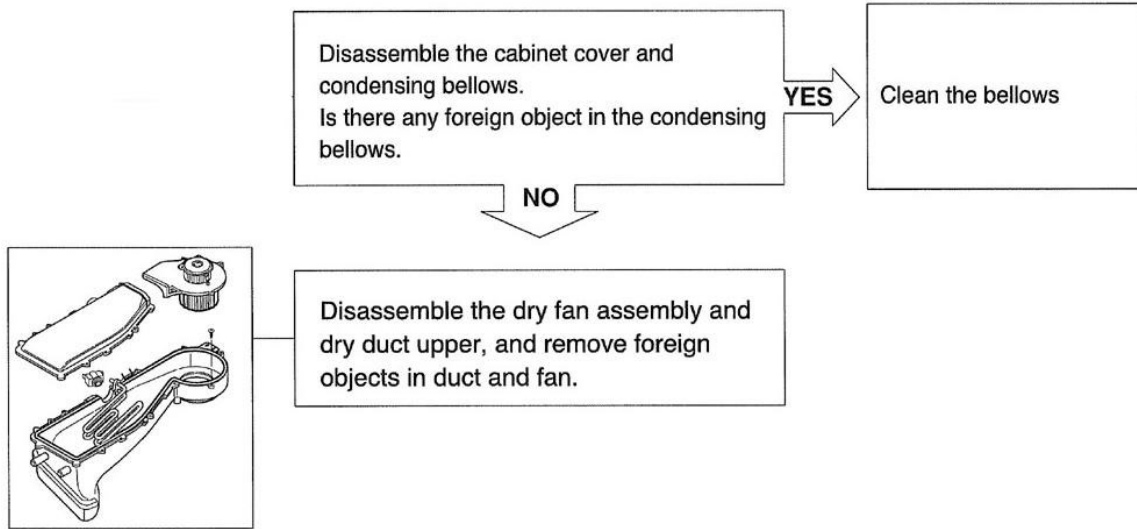

DRYER HEATER MALFUNCTION

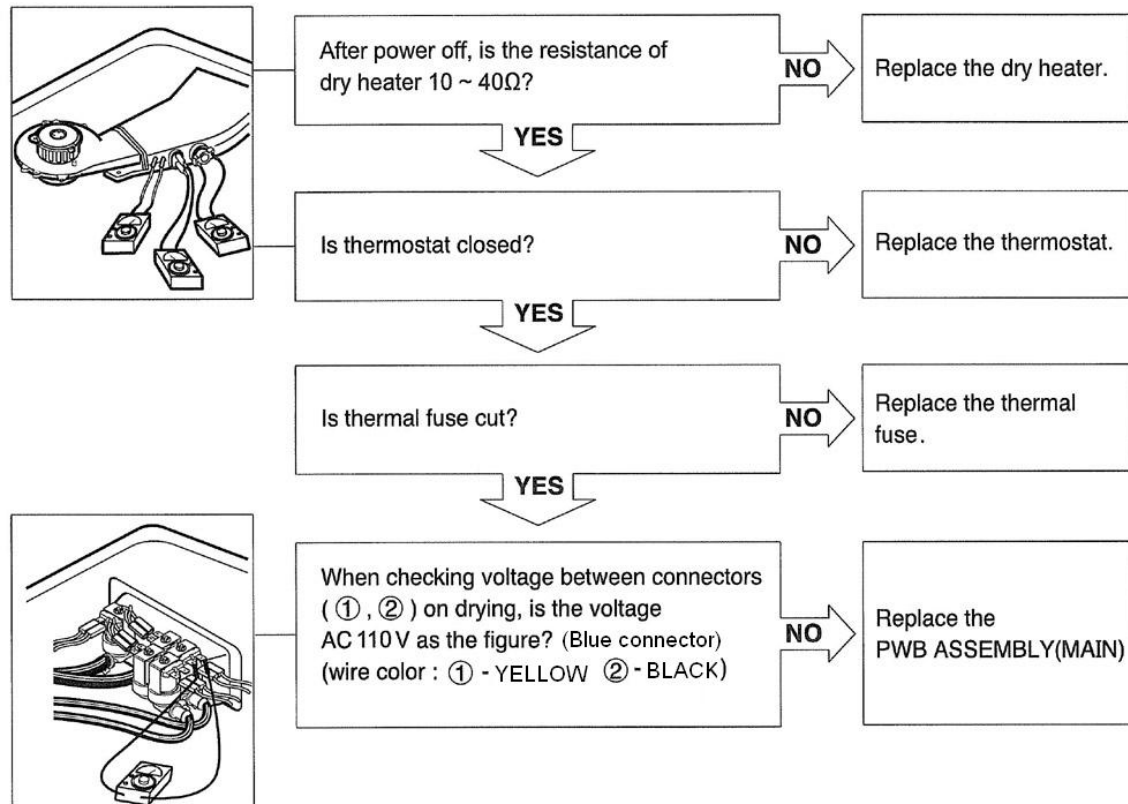

Repair instructions are on page 55.

DISASSEMBLY and REPAIR

CONTROL PANEL

Unplug the COMBO before disassembly and repair.

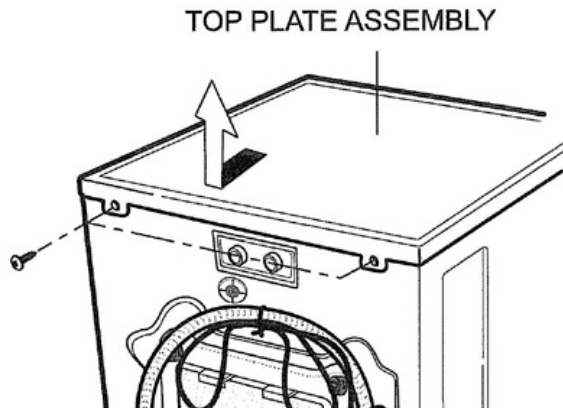

1. Remove the two screws on the top of the back plate.
2. Slide the top plate backward and lift it, as shown.

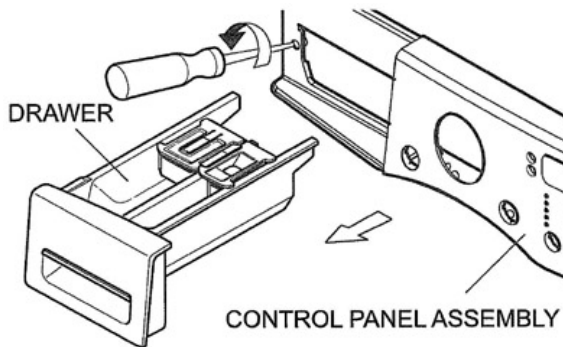

3. Disconnect the Display PWB connectors. (3 connectors)
4. Remove the dispenser drawer.
5. Remove the two screws behind the dispenser drawer.
6. Lift off the left side of the Control Panel and pull it out.

DISPLAY PWB ASSEMBLY

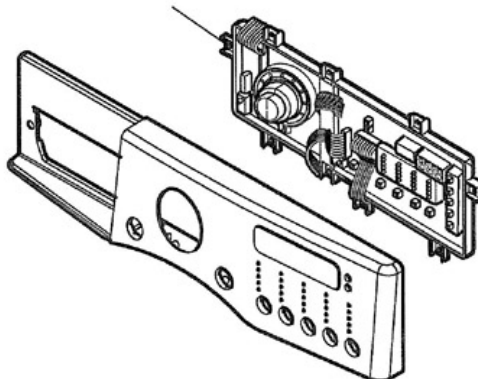

7. Remove the nine screws that secure the PWB.
8. Remove the PWB.
9. Reassembly is the reverse of these steps.

MAIN PWB

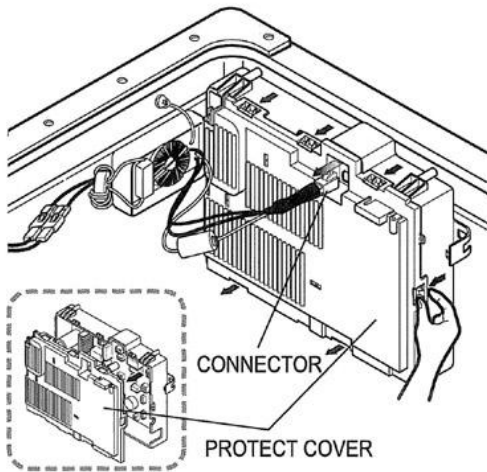

1. Disconnect the POWER connector and the SENSOR SWITCH assembly.
2. Remove the protective cover by lifting the plastic clips around the top and sides.

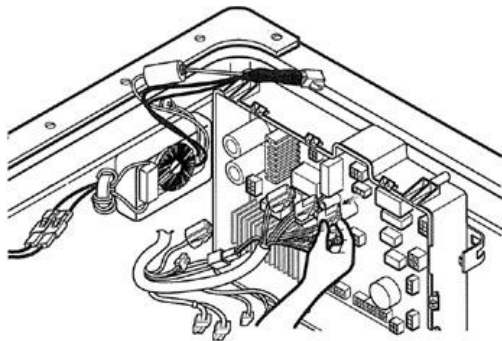

3. Disconnect all the connectors. Note that they are all different shapes and colors to prevent any mistakes upon replacement.

(See photo, page 57.)

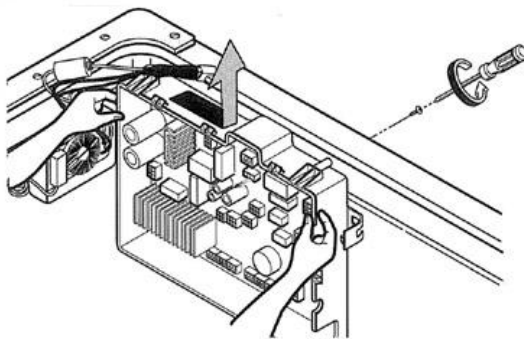

4. Remove the screw on the back.
5. Remove the MAIN PWB from the COMBO. Slide it to the right and then lift.
6. Reassembly is the reverse of these steps.

DISPENSER

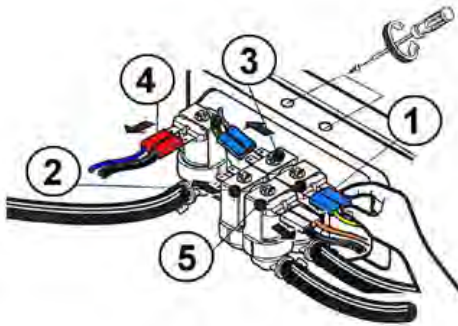
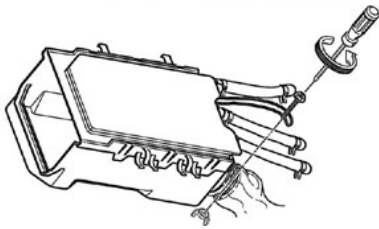
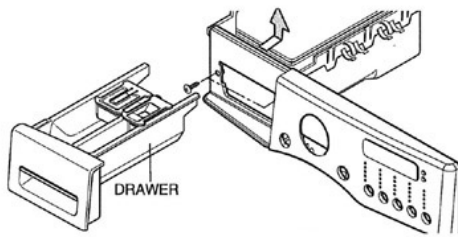

1. Remove the top plate.
2. Remove the dispenser.
3. Remove the two screws from the front of the dispenser.
4. Remove the clamp and the large hose on the back of the dispenser.
5. Leave the small feed hoses on the dispenser.
6. Disconnect the electrical connectors on the valves. The connector and wire colors will aid upon reassembly.
7. Remove the two screws that secure the cold water valve assembly.
8. Reassembly is the reverse of these steps.

Valve Assembly Wire/Connector Chart

(#)	(Connector)	(Wire)	(Dispenser valve opened)
1	BLUE	Yellow and Black	(dryer water - cold)
2	WHITE	White and Black	(main wash - cold)
3	BLUE	Gray and Black	(pre-wash - cold)
4	RED	Blue and Black	(hot input)
5	WHITE	Orange and Black	(bleach - cold)

(To dispense softener, both the main and pre-wash solenoids are opened. See page 16 for details.)

NOISE FILTER

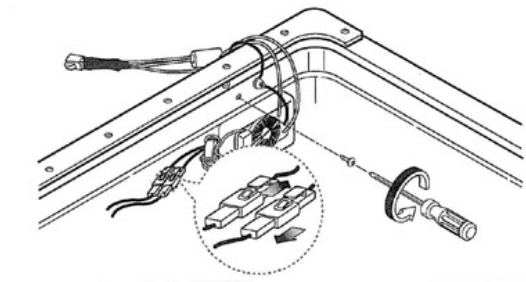

1. Unplug the power connection from the MAIN PWB.
2. Disconnect the two connectors from the power cord.
3. Remove the screw and ring connector for the ground. Replace the screw and any wires other than the ground for the noise filter.
4. Remove the screw securing the noise filter to the frame of the COMBO.
5. Replacement is the reverse of these steps.

FRONT CABINET COVER

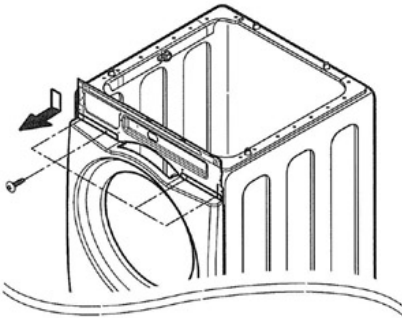

1. Remove the four screws from the top edge of the front cabinet cover.

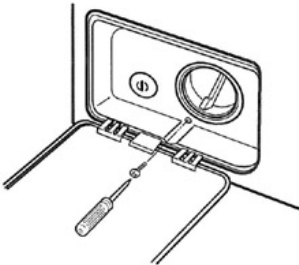

2. Remove the screw behind the filter cover.

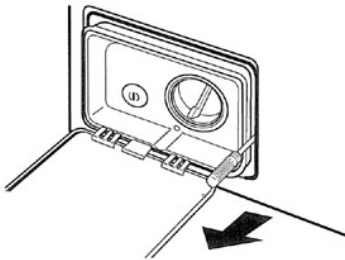

3. Use a putty knife or screwdriver on both sides (one at a time) of the filter cover and pull it out.

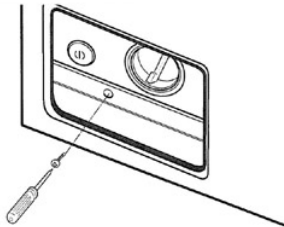

4. Remove the screw that was hidden by the filter cover.

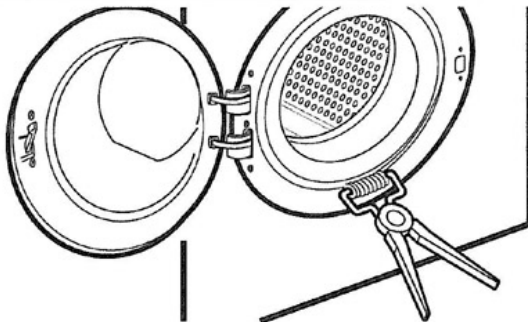

5. Open the COMBO door.
6. Use the special gasket pliers (part # **383EER4001A**) to remove the gasket clamp/spring assembly.

(See photo, page 66.)

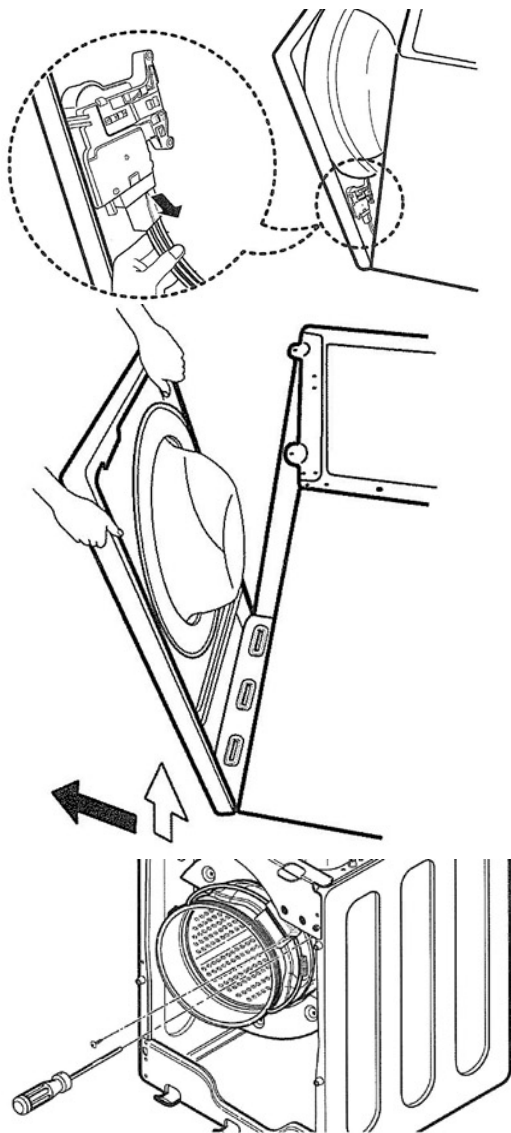

7. Tilt out the cabinet cover.
8. Disconnect the door switch connector. (Don't forget it when you put the cover back on!)
9. Lift the cabinet cover (front) off and set it aside where it will not fall or be damaged.
10. Remove the gasket clamp on the tub side.
11. Remove the gasket.

DOOR

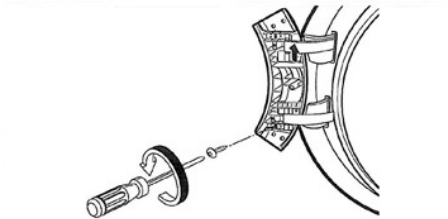
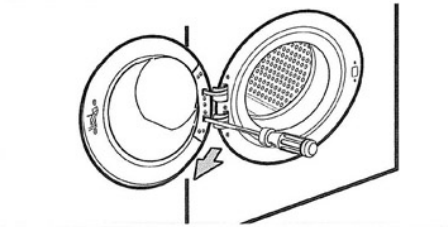
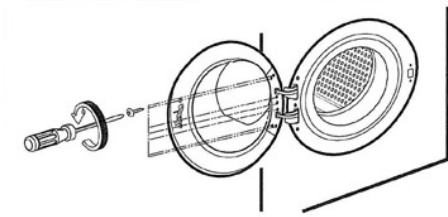

1. Open the door.
2. Remove the seven screws from the hinge cover.
3. Put a flat screwdriver into the hinge opening and gently pry off the hinge cover.
4. Remove the screw from the lower hinge pin.
5. Lift the door off the hinge.

BE CAREFUL! The door is heavy!

DOOR LOCK SWITCH ASSEMBLY

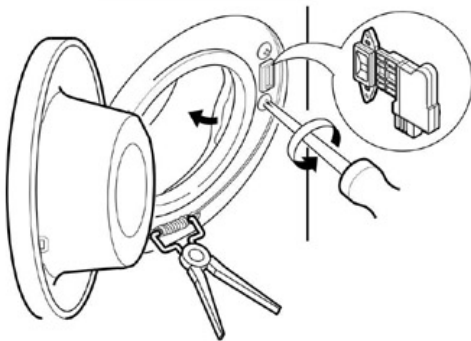



1. Open the door.
2. Using the special pliers, remove the gasket clamp.
3. Remove the screws.
4. Pull the switch out and disconnect the wiring harness.

NOTE! Be sure you reconnect the wires when you replace the switch.

MOTOR

The direct drive motor is a brushless DC motor built on the shaft of the drum. The elimination of belts and pulleys allows greater efficiency and reliability with less noise and vibration. The use of direct current allows the MICOM to control both the speed and the direction of rotation. There are no brushes to wear away as in a conventional electric motor. Unlike a more traditional brushless motor, the Direct Drive's rotor surrounds the stator rather than being attached to it. A Hall sensor reports the motor's speed to the MICOM.

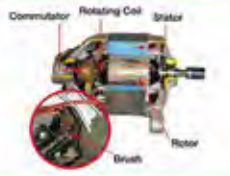
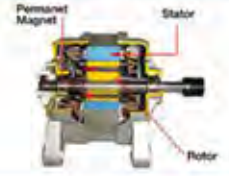
DIRECT DRIVE MOTOR

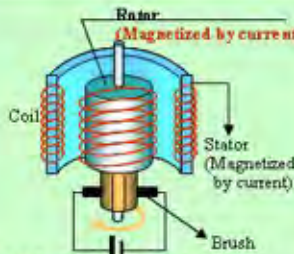
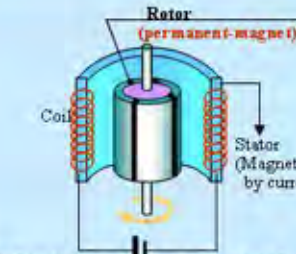
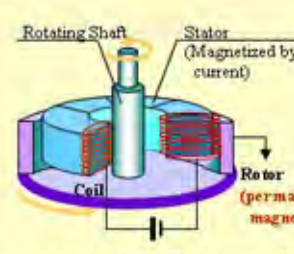
Universal AC Motor	BLDC Motor	Direct Drive Motor
		
 <p>Brush delivers electricity to rotate the coiled Rotor.</p>	 <p>Rotor is a permanent magnet. It does not need a Brush.</p>	 <p>Permanent magnet Rotor and Multi-coiled Stator are big and powerful enough to replace the pulley.</p>
<ul style="list-style-type: none"> ● Brush makes Friction Noises ● Coiled rotor needs electricity. ● Brush abrades and needs replacement. 	<ul style="list-style-type: none"> ★ No Friction Noises ★ Rotor doesn't need electricity ★ No brush replacement 	<ul style="list-style-type: none"> ★ Powerful & Reliable control ★ Minimum vibration & noise ★ Optimum energy consumption

MOTOR (continued)

This motor is a 36-pole DC direct-drive motor. There are 12 magnets permanently attached to the rotor. Each magnet is opposite 3 poles of the stator at any given time. A Hall Effect sensor is mounted on the stator. It counts the poles of the magnets as the rotor turns to feedback the information to the controller. The motor controller can determine the direction and speed of rotation by adjusting the polarity and amplitude of the power applied to the stator.

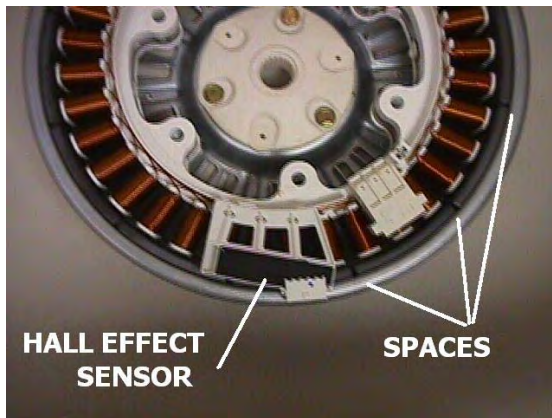

The Hall Effect sensor is easily removed and replaced. You'll have to remove the rotor and stator to access the sensor. The rotor is splined and fits snugly on the drum's shaft. When replacing the rotor, you will probably need a helper to hold the drum in place while you push the rotor onto the shaft. Otherwise, the drum may move forward far enough to make it difficult to replace the bolt. The helper can also keep the drum from turning while you torque the bolt.

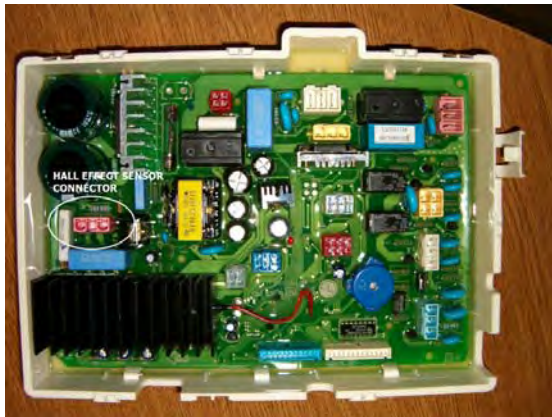

Before going to this trouble, check the connector on the main board. It is the 3-pin red connector nearest the heat sink. (This connector has the red wire in the middle instead of on one end.) You can separate this connector to determine that the board is receiving signals from the Hall Effect sensor.)

wrong connector it is the yellow one near the top

MOTOR (continued)

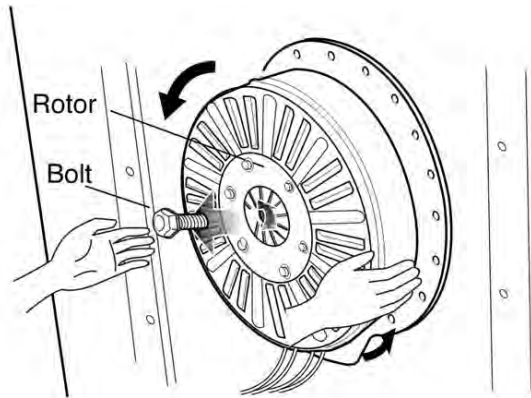

1. Remove the back cover.
2. Remove the large bolt (17 mm) from the center of the rotor.
3. Pull the rotor off the shaft. (You may have to wiggle it off. The shaft is splined. When replacing it, you may need a helper to keep the drum from being pushed forward so the bolt will reach and can be tightened.)

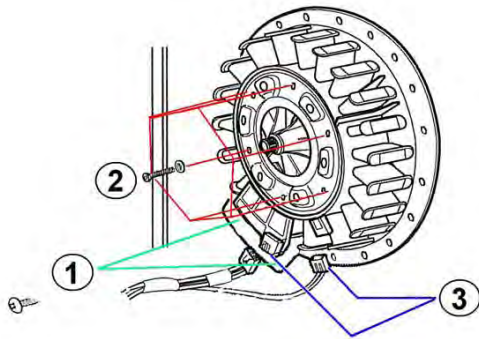

1. Remove the two screws from the tub bracket.
2. Remove the six bolts on the stator.
3. Remove the two electrical connectors on the stator.

DAMPER

The dampers (3) support the tub at the bottom; it is supported by two springs at the top and by the gasket on the front. Use special tool **383EER4003A**. (See photo, pages 47 and 66.) Hold in the locking tab so the pin will slide out.

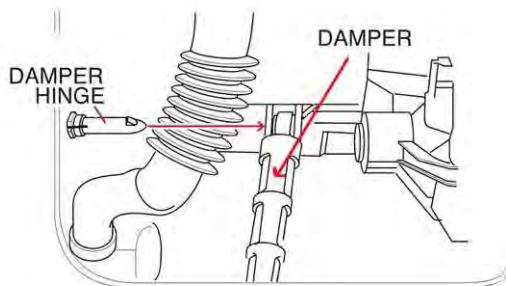

1. Remove the damper hinge pins. (A special tool is available for this. Using a $\frac{5}{8}$ " deep well socket makes this easier by holding down the locking tab so the pin slides out easily.)
2. Replace the damper with a new part. Do not reuse a damper that has been disassembled.

TUB REMOVAL AND REPAIR

Removing the tub requires that you first remove the control panel and the front panel. The front panel can be removed without removing the door. (See previous pages for this procedure.) When the front has been removed, it is easy to remove the tub. Remove the counterweights first to make this job easier. Regardless, most of this procedure will require a helper.

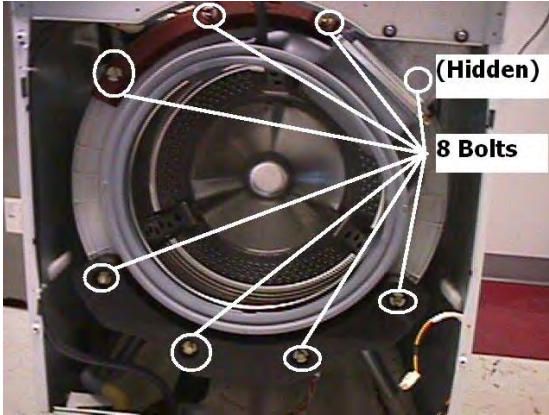

1. Remove the bolts retaining the weights. (4 per weight)
2. Set the weights aside where they will not fall and break or cause injury.

The weights balance the motor when removing the tub. If you remove them, the tub will be back-heavy.

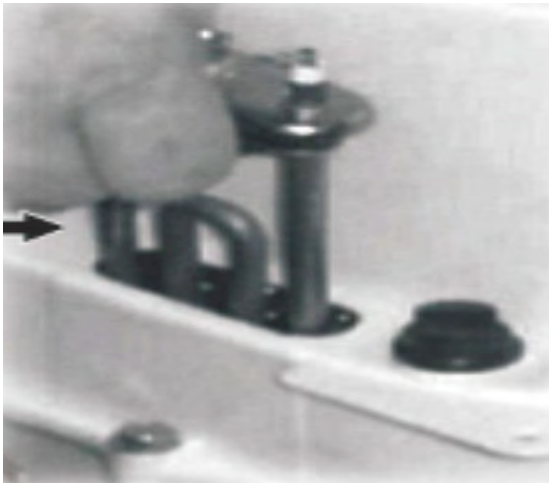

3. Disconnect the wire lead to the thermistor.
4. Disconnect the wires on the heating element.
5. Remove the center bolt securing the ground and the element.
6. Pull the element out carefully.

TUB REMOVAL AND REPAIR, continued.



1. Remove the back cover. (Six screws.) Remember to drain the water if you haven't already done it.

2. Remove the large bolt securing the rotor. This is much easier if there is an assistant available to hold the drum still on the inside while loosening the bolt. Extreme torque is not required when replacing the bolt; instead use a drop of Loctite®.

Use extreme caution! This part holds the motor's permanent magnets.



3. Disconnect the electrical connections and grounding screw.

4. Remove the 6 bolts that hold the windings in place.

5. Disconnect the small hose that attaches to the water level sensor.

6. Disconnect the dryer duct hose.

7. Disconnect the drain hose on the back of the pump.

8. Disconnect the recirculating hose at the top of the door gasket.

9. Disconnect the air vent hose. Be especially careful of the ball check valve. It must be replaced correctly to function properly.

10. Disconnect the vacuum break.



TUB REMOVAL AND REPAIR, continued.

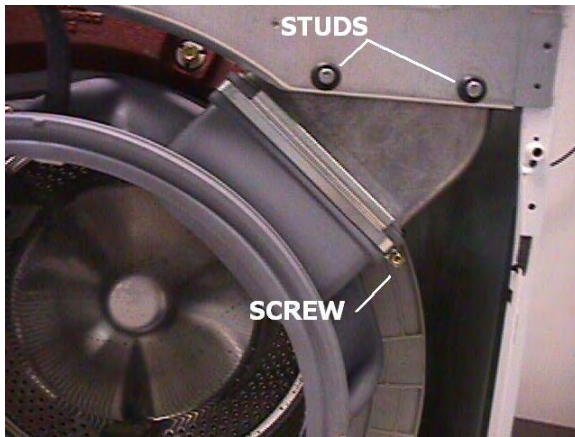

11. Remove the clamp where the dryer duct connects to the gasket. Separate the gasket and duct for when the tub comes out. This will allow the dryer assembly to remain in place when the tub comes out.

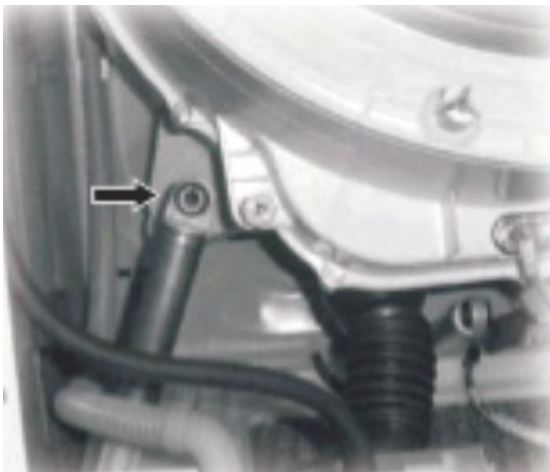

12. Remove the three dampers that support the tub.

BE CAUTIOUS! Separated dampers must be replaced.

Press in the tab on the small end and use the pliers to push the pin out. It is easiest to remove the bottom pin first. After removing the drum, the pin on the other end is easy to reach if it must be removed at all.

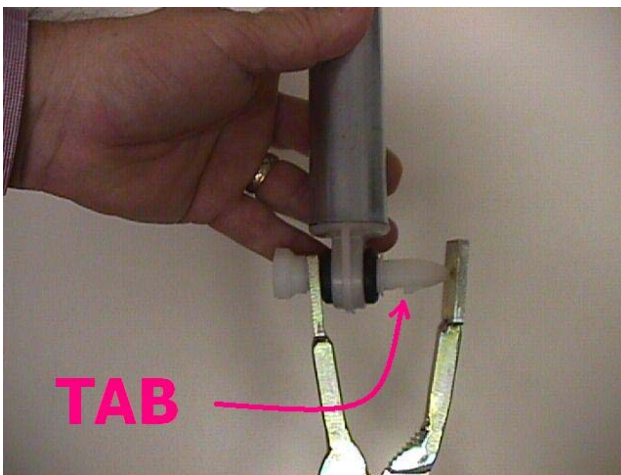

13. Use special tool **383EER4003A** to remove the pins. Press the security tab in to push the pin through.

Attach the larger, metal end to the drum and the smaller, plastic piston end to the frame of the COMBO. (Insert the pins from the front on the two side dampers, and from the right on the rear damper.)

TUB REMOVAL AND REPAIR, continued.

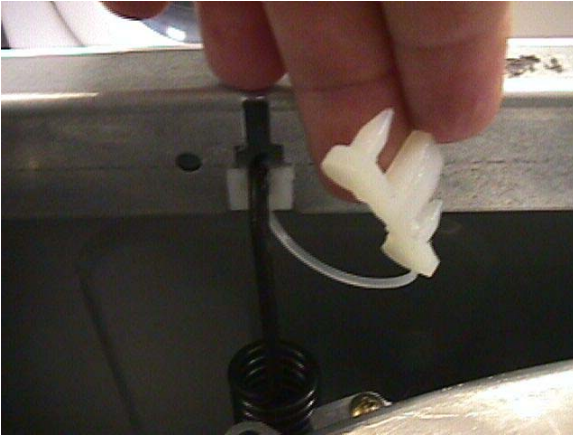

14. Open the spring clip on each side where the spring supports the tub.
15. Lift the springs out of the holders and take the tub out through the front of the COMBO.

(This may require a helper!)

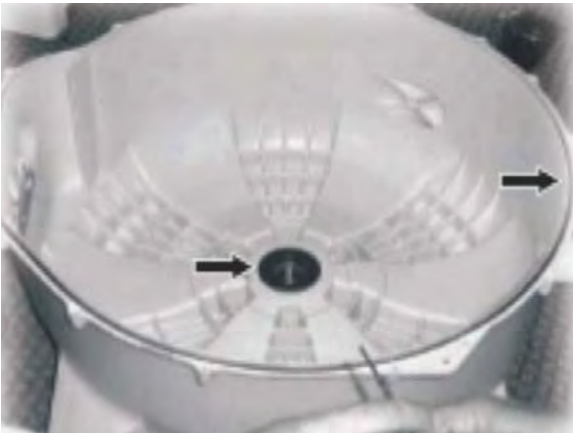

16. Separate the tub halves to remove the drum. Remove the bolts around the circumference of the tub. Do not use a screwdriver or other sharp instrument to pry the halves apart. (The bearing is visible in this photo.)
17. Do not disturb the seal (gasket) between the tub halves unless it requires replacement.

TUB REMOVAL AND REPAIR, continued.



18. Remove two bolts from the end on the spider of the drum. Then remove the screw on the outside of the drum. Squeeze the sides of the baffle slightly to release the positioning tabs.



19. Repairing or replacing the roller jet (baffle) requires removing the drum.

Remove the three screws that secure the inner part. Lift it out and remove the six glass roller balls.

The roller balls help turn the clothes over and the baffle fills up with water as the drum rotates, allowing it to shower that water out as it continues to rotate.



20. As always, reassembly is basically the reverse of these steps.

WATER LEVEL SWITCH

The water level detector switch monitors the water level and feeds this information to the MICOM. The sensor reads air pressure in an air chamber on the tub. The air pressure changes in relation to the depth of the water, moving a diaphragm in the switch. As the water level fluctuates, it raises or lowers the iron center in the coil, which, in turn, changes the electric resonance of the oscillator circuit of which it is a part. As water level decreases, frequency increases. (e.g. A low water level may read 25.5kHz, while a high water level may read 21.4 kHz. These readings are approximate; washers in the field may vary slightly from these figures.)

To read the frequency while the COMBO is running, press and hold the SPIN SPEED and SOIL LEVEL buttons. The number on the display should be divided by 10 to obtain the frequency reading in kHz. A display of 254 would indicate a frequency of 25.4 kHz. The MICOM interprets the frequency reading as one of eight levels, with one being the lowest water level and any level greater than eight indicating an overflow situation.

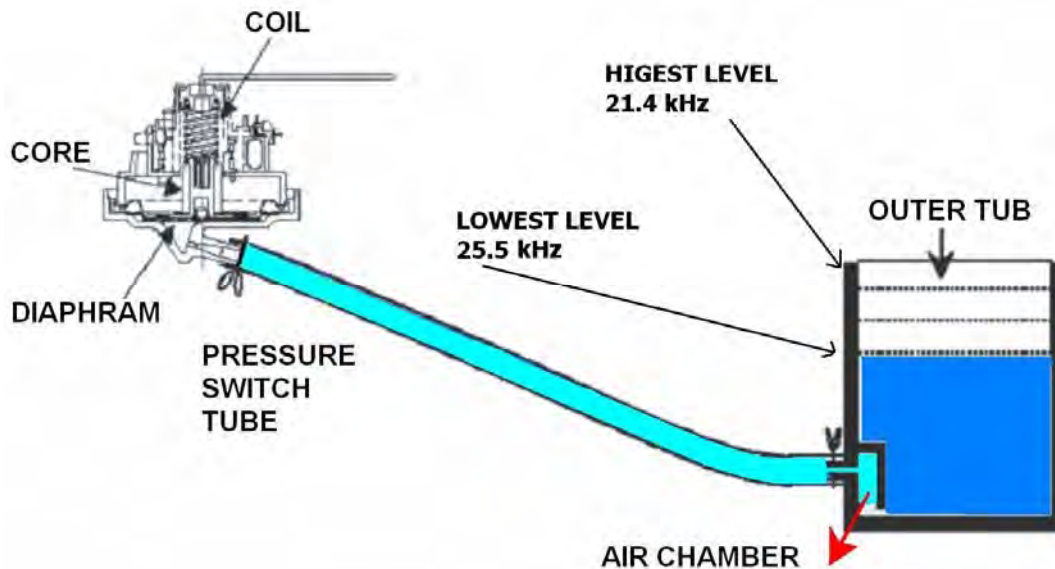

PUMP

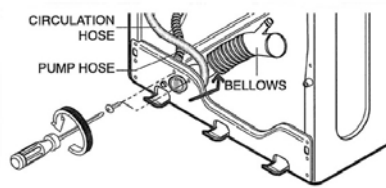

1. Remove the cabinet (front).
2. Remove the pump hose, the bellows, and the circulation hose from the pump body.
3. Remove the two screws on the front plate.
4. Push the pump backward and lift it out. (See drawing.)

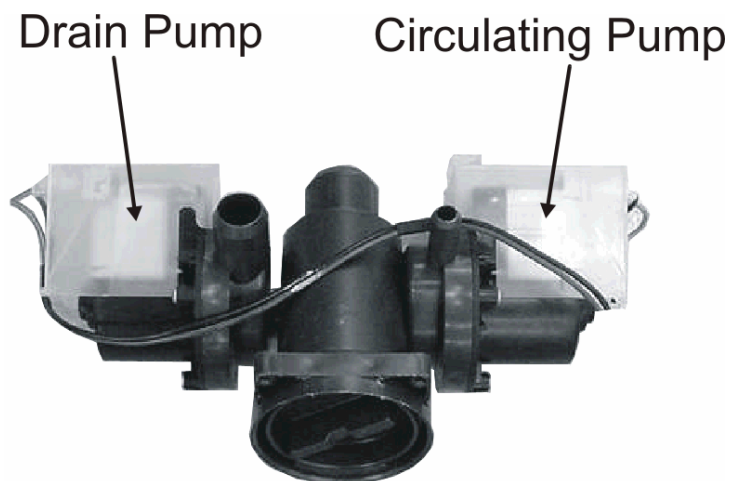

The drain pump and the circulating pump are attached to either side of the filter housing. The drain pump is used to exhaust the water from the washer. The recirculating pump serves three purposes: it sprays water from the tub onto the laundry, creating a better saturation of detergent and better rinsing, it keeps the window clean, and it allows the customer to see water in the tub. The filter are between the pumps is not a lint filter in the traditional since. It serves to trap larger objects (keys, coins, buttons, etc.) that may find their way into the washer and protects the pumps from physical damage.

WATER HEATER

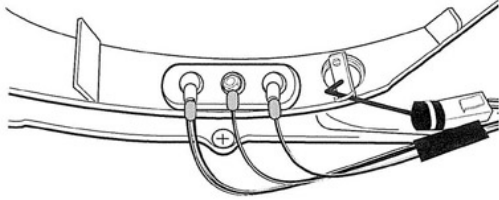

1. Remove the front cover.
2. Separate the connectors from the heater element.
3. Remove the nut (also the ground connection) and pull the heater out.

THERMISTOR

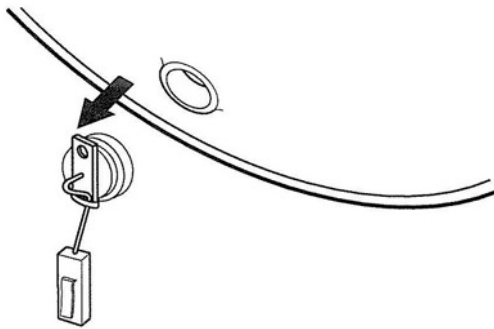

1. Remove the front cover.
2. Disconnect the thermistor at the white connector.
3. Pull the thermistor out by the bracket.

REMOVAL OF FOREIGN OBJECTS BETWEEN TUB and DRUM

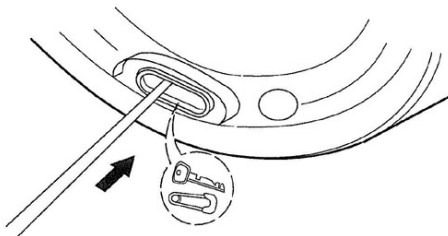

1. Remove the front cover.
2. Remove the heater from the tub.
3. Use a long bar or a wire to fish out anything that could be in the space there.

BALL SENSOR (Unbalance Switch)

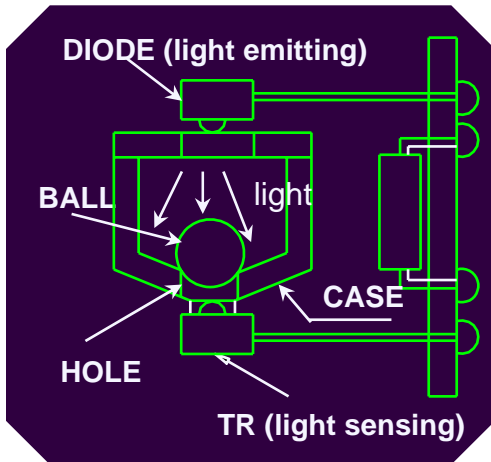

The BALL SENSOR is so named because it contains a small ball covering an even smaller hole. The ball rests so it blocks the light from the LED above from shining through the hole to the phototransistor below. If the tub moves enough to strike the ball, the ball is moved temporarily from its resting place, allowing the light to trigger the phototransistor. This, in turn, causes the drum rotation to stop and then attempt to rebalance the load.

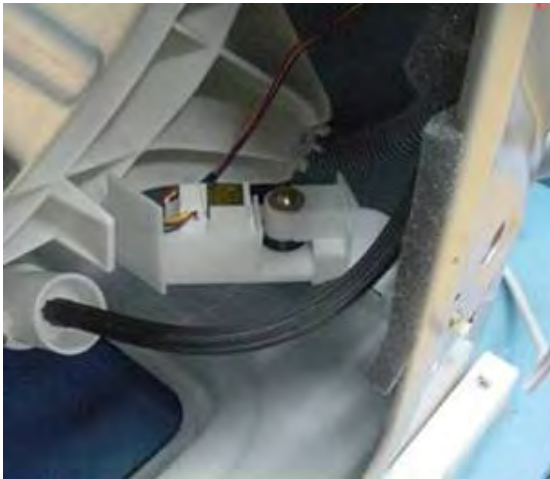

The sensor assembly is bolted to the back of the washer near the bottom. The tub (surrounding the drum) is suspended on springs and dampers to allow some motion while the drum rotates. However, if the load is out of balance and the tub moves too far out of place, a tab on the tub will strike the ball sensor.

The black hose connects the air chamber to the water level switch. If this hose fails or is broken off its connector, the COMBO will continue to fill because the sensor does not detect an increase in water level.

BALL SENSOR (continued)

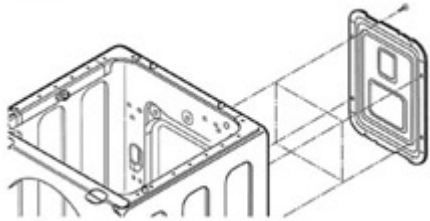

1. Remove the four screws and the back cover.

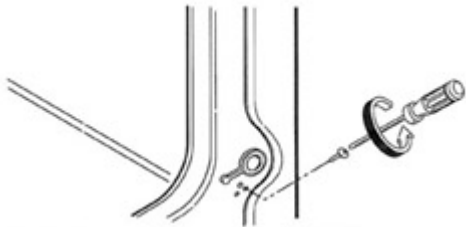

2. Remove the single screw that secures the sensor (bottom right as you face the back of the COMBO.)



3. Separate the connector.

DRYER REPAIR

The dryer portion of the COMBO is a condenser type dryer. It works on the principal that water condenses on a cool surface, similar to moisture collecting on a cold drink on a hot and humid summer day. A fan circulates air through the warming duct, drum, and condenser and over and over. The air is warmed because warmer air holds more moisture than cooler air and the heat causes more of the water to be evaporated from the laundry. The warm, moist air is directed through the condensing duct, which is cooled by a spray of cold water. This difference in temperature causes the moisture to precipitate in the condenser, where it and the cooling water are exhausted by the drain pump. The air, now dry, is passed over the warming element and through the laundry again as the process repeats itself. Because the air is recycled instead of exhausted, a vent and lint filter are not necessary for this type dryer.

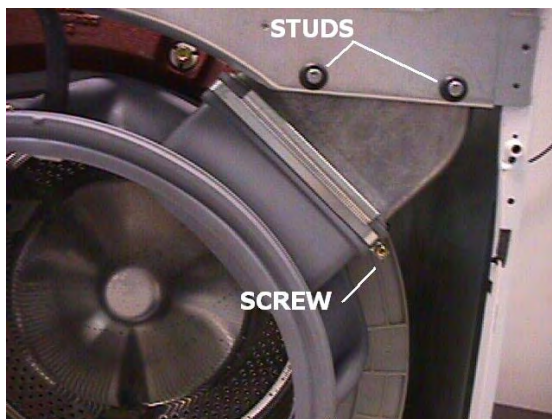

1. Remove the clamp screw and pull the boot off the dryer duct.
2. Disconnect all the electrical connections from the dryer duct.
3. Remove the two screws that secure the dryer fan housing to the back of the cabinet.
4. Lift the dryer fan housing and duct off from the back end to clear the cabinet. The studs will pull free and you can remove the heater assembly.

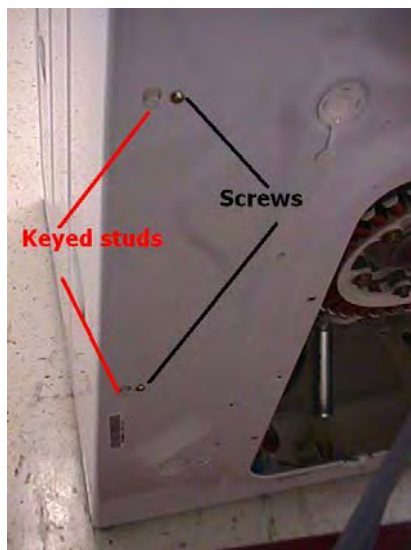

5. Remove the two screws that hold the condenser duct to the back cabinet.

If you haven't drained the water from the tub, this would be a good time to do it.

6. Disconnect the condenser boot on the tub end. (This will aid disassembly and assembly because it easier to reach.)

Dryer Repair, continued



7. Release the clamp and remove the dryer water supply hose at the solenoid end.

Lift out the condenser duct assembly. Be careful to avoid damaging the boot.



8. Leave the hose in the duct end.

If this comes out, you must first fit the gasket into the hole in the duct, with the smaller side of the gasket facing the duct. Then insert the hose connector and rotate it 90° to lock it in place.
9. Dryer reassembly is the reverse of these steps.

Test and diagnostic procedures are shown on pages 33~34.

MAIN BOARD

The main board controls all the functions of the COMBO. All the sensors in the machine report to the main board and the microprocessor makes all adjustments based on sensor input. There are no panel controls for such things as water level or washing time because these are determined via fuzzy logic based on the selected cycle and sensor input.

The main board is potted into a plastic case to protect it from vibration and water. It cannot be repaired and must be replaced as an assembly.

The connectors on the main board are color coded (See Wiring Diagram, page 58.) and are unique. It is not possible to cross the connectors. They are identifiable by pin count, conductor count, and shape, as shown on the diagram. Two less common color abbreviations on the diagram are SB (Sky Blue) and NA (Natural, which is cream or white.)

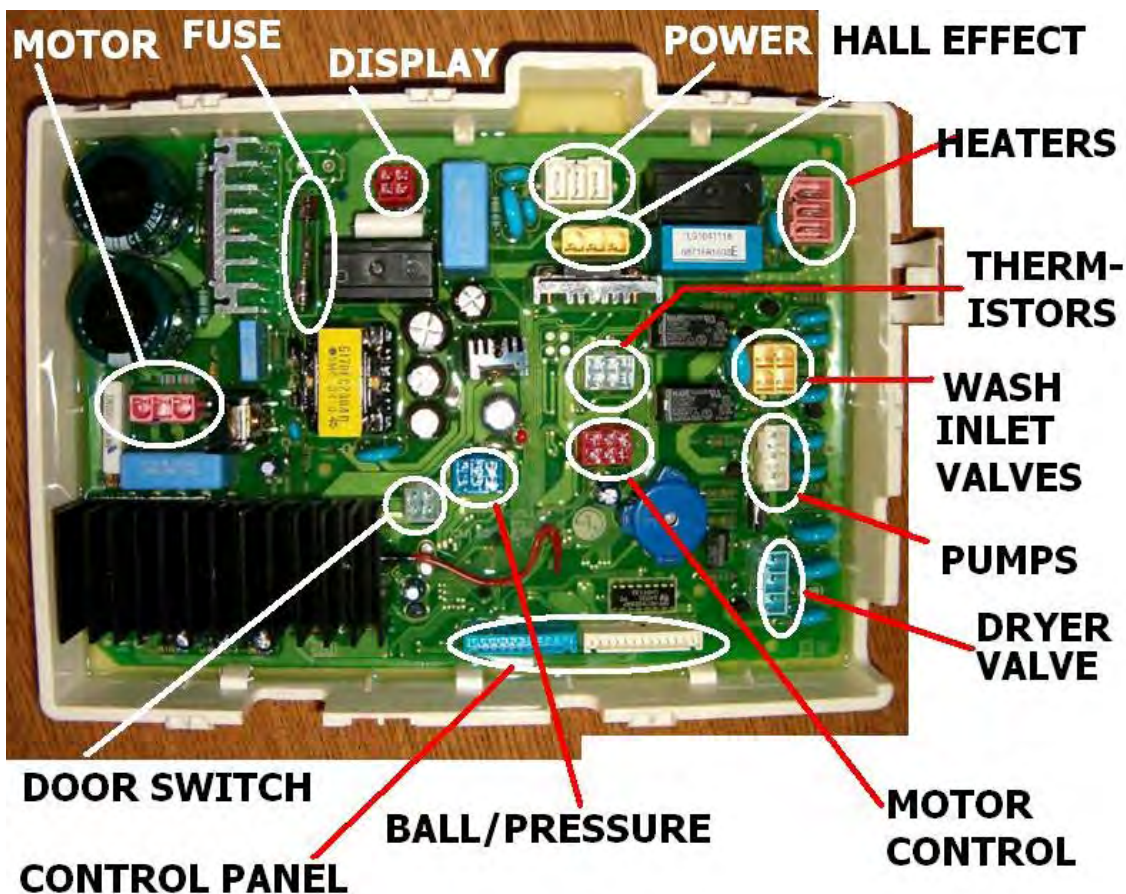

WIRING DIAGRAM

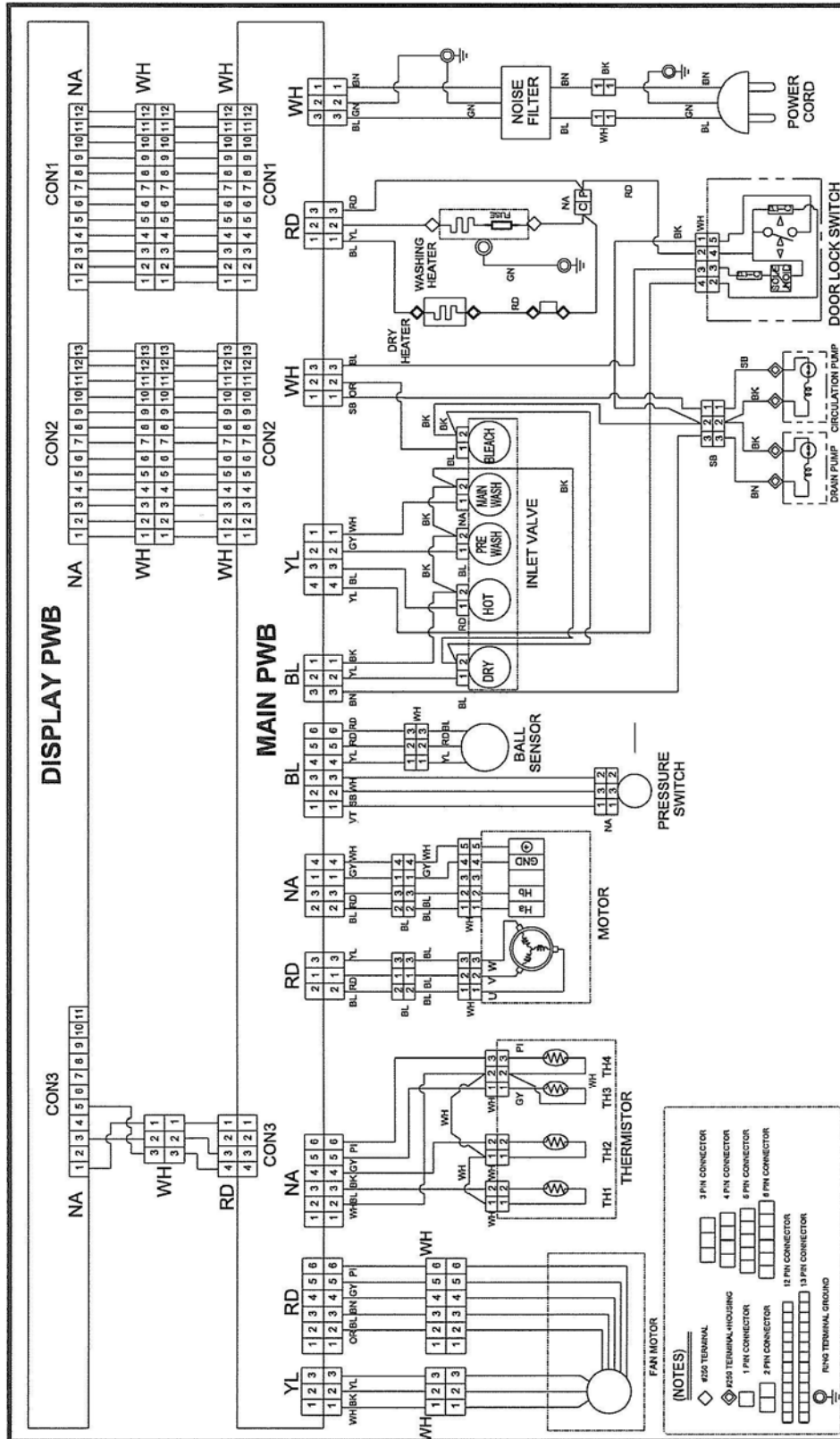

EXPLODED VIEW (Control Panel and Cabinet)

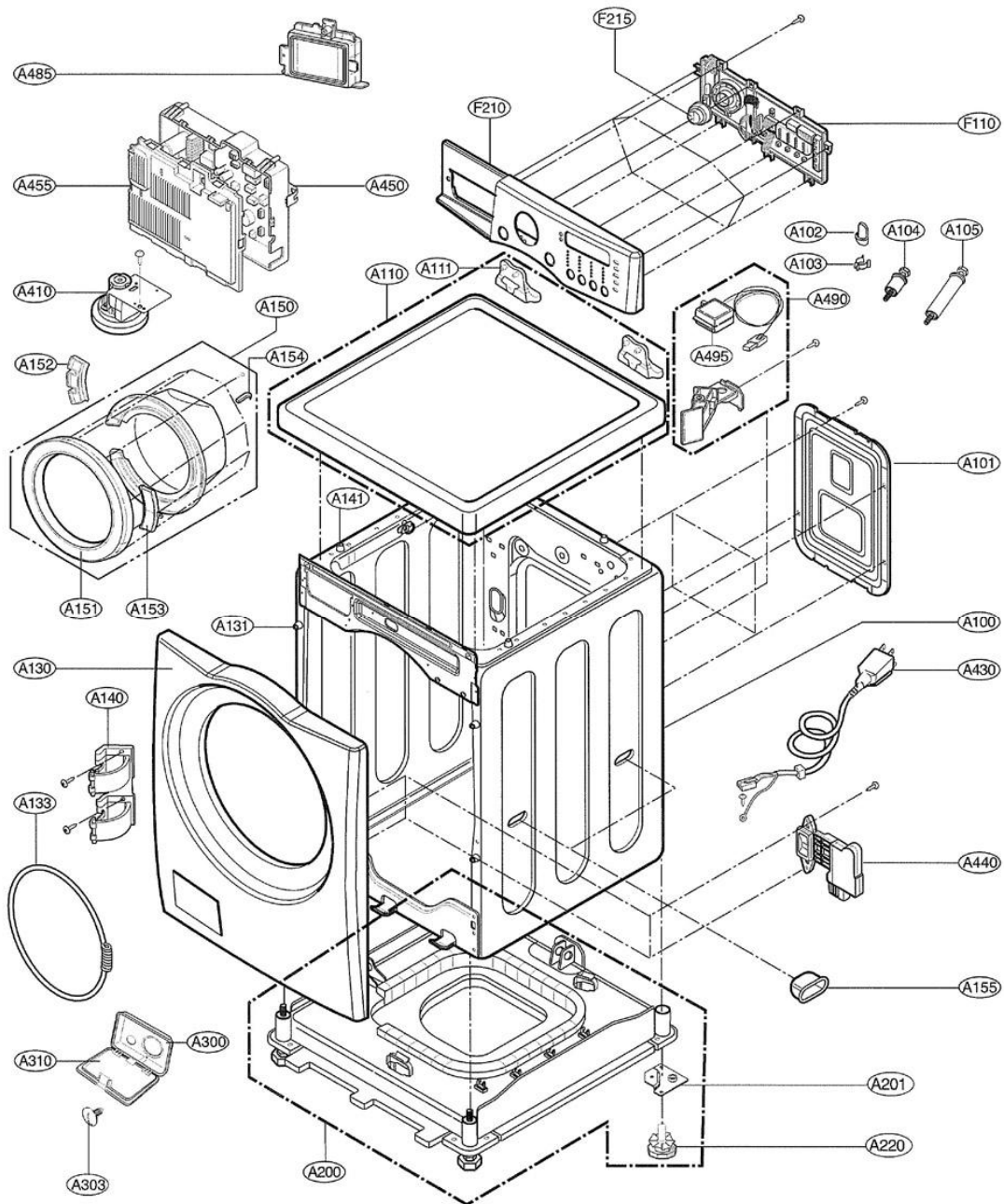

EXPLODED VIEW (Drum and Tub)

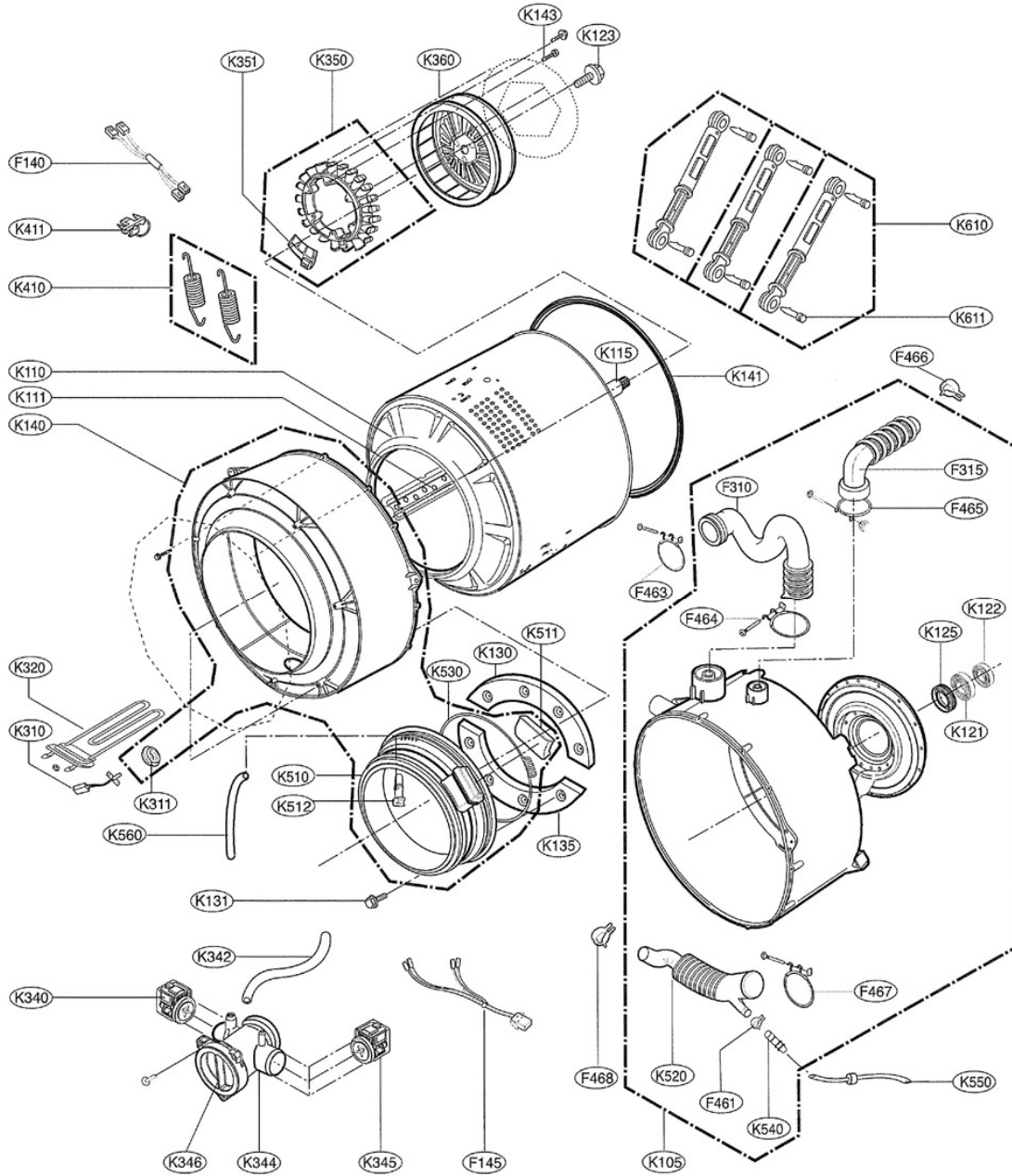

EXPLODED VIEW (Dispenser)

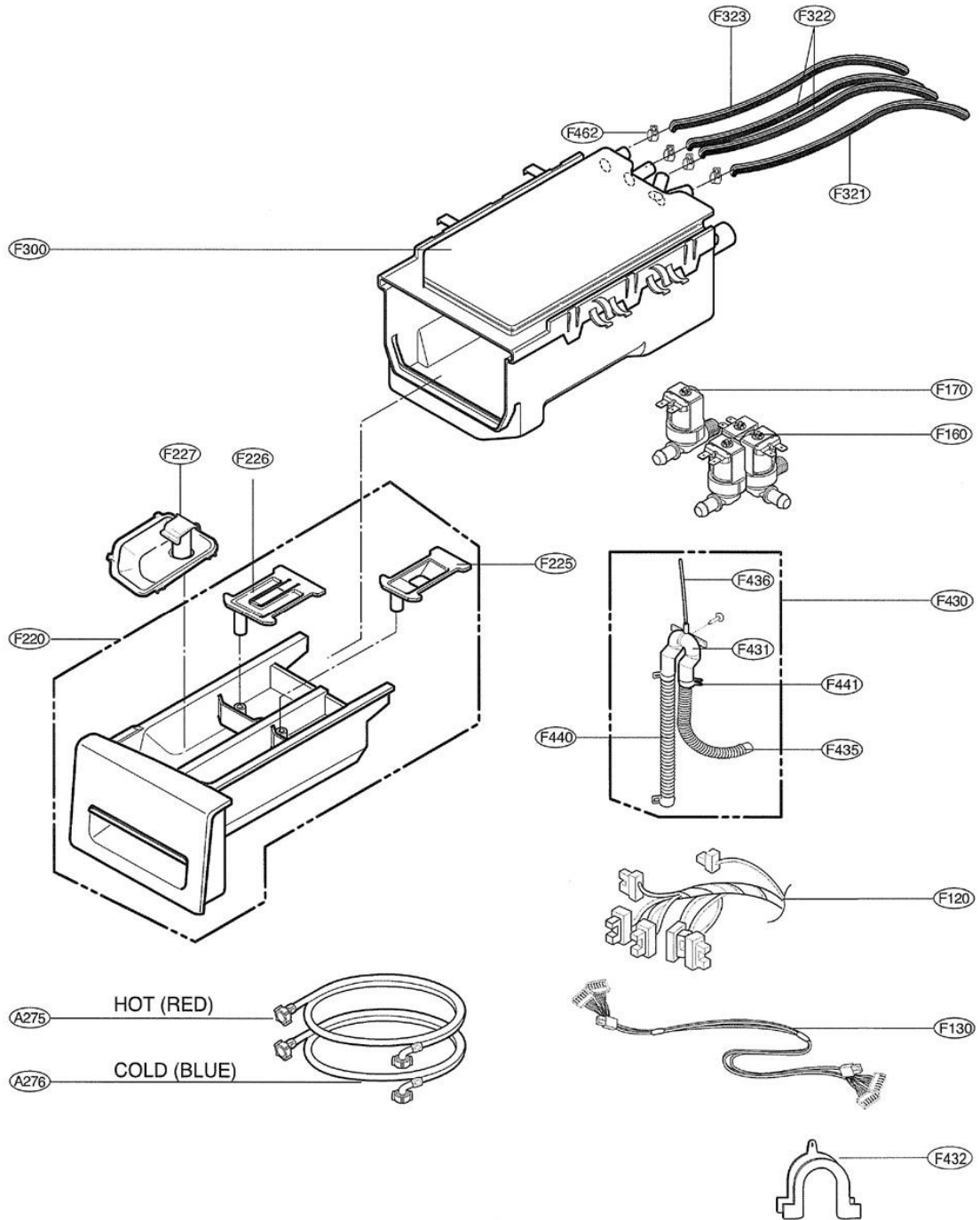

EXPLODED VIEW (Dryer Parts)

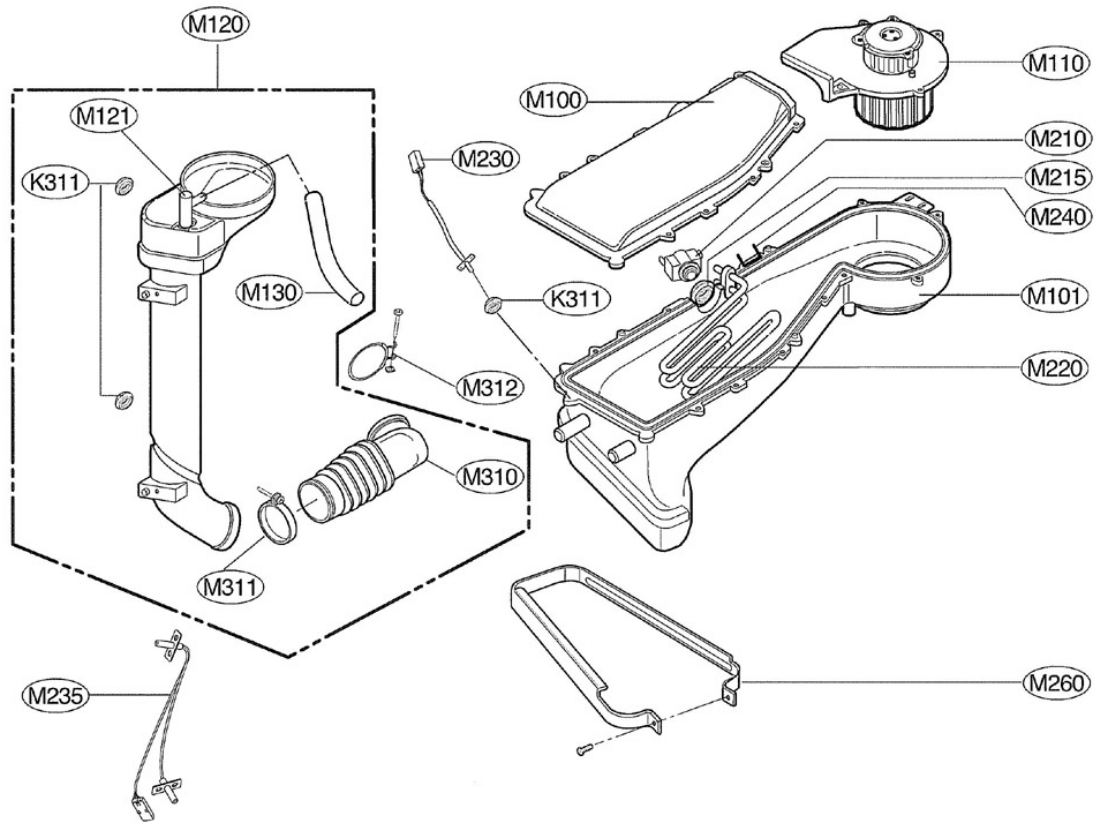

PARTS LIST

Loc #	Part No	Description
*001	3829ER3025L	OWNERS MANUAL
*002	3890EZ3524A	BOX
*003	3W20018B	WRENCH
*004	3828ER3027G	SERVICE MANUAL
A100	3091ER0004A	CABINET ASSEMBLY
A101	3808FR1202A	BACK COVER
A102	4830ER3001A	BUSHING
A103	4930ER3014A	HOLDER
A104	4011FR3159E	BOLT ASSEMBLY
A105	4011FR3159D	BOLT ASSEMBLY
A110	3457ER1006A	TOP PLATE ASSEMBLY
A111	4810ER3021A	HINGE BRACKET
A130	3551ER0023A	CABINET COVER ASSEMBLY
A131	4930ER4005A	HOLDER
A133	2W20017E	CLAMP ASSEMBLY
A140	4775ER2002A	HINGE ASSEMBLY
A141	4930ER4018A	HOLDER
A150	3581ER1008A	DOOR ASSEMBLY
A151	3212ER1023A	INNER DOOR FRAME
A152	3212ER1016A	INNER DOOR FRAME
A153	3650ER2004A	HANDLE
A154	4026ER4004A	LATCH HOOK
A155	3650FA3488M	HANDLE
A200	3041ER0001C	CABINET BASE ASSEMBLY
A201	4810ER3006A	BASE BRACKET
A220	4779ER3002A	LEG ASSEMBLY
A275	5215FD3715G	INLET HOSE
A276	5215FD3715H	INLET HOSE
A300	3110ER2003A	CASE
A303	5006FR3146D	DRAIN HOSE CAP
A310	5006ER2003E	DRAIN COVER
A410	6601ER1006E	SENSOR SWITCH ASSEMBLY
A430	6411ER1005K	POWER CORD ASSEMBLY
A440	6601ER1004C	DOOR SWITCH ASSEMBLY

Loc #	Part No	Description
A450	6871ER1003E	MAIN PWB (PCB) ASSEMBLY
A455	3550ER1020A	MAIN PWB PROTECTIVE COVER
A485	6201EC1006A	FILTER ASSEMBLY(CIRC)
A490	4811ER3001A	BRACKET ASSEMBLY
A495	6501FA2462C	SENSOR ASSEMBLY
F110	6871EC1116B	DISPLAY PWB (PCB) ASSEMBLY
F120	6877ER1023J	PWB HARNESS
F130	6850EC2001D	FLAT CABLE
F140	6877ER1016B	MOTOR HARNESS
F145	6877ER3003B	MOTOR HARNESS
F160	5220FR2008E	VALVE ASSEMBLY, INLET
F170	5220FR2006H	VALVE ASSEMBLY, INLET
F210	3721ER1126D	CONTROL PANEL ASSEMBLY
F215	4941ER3002A	KNOB ASSEMBLY
F220	3721ER1073N	DRAWER PANEL ASSEMBLY
F225	5006ER3014B	CAP, SOFTENER
F226	5006ER3018A	CAP, SIPHON
F227	3891ER2003A	BOX ASSEMBLY, DETERGENT
F300	4925ER1015B	DISPENSER ASSEMBLY
F310	4738ER1004B	BELLOWS
F315	4738ER2002A	BELLOWS
F321	5214ER4001A	HOSE, INLET
F322	5214ER4001B	HOSE, INLET
F323	5214ER4001J	HOSE, INLET
F430	5215ER2002G	DRAIN HOSE ASSEMBLY
F431	4932FR3156A	CONNECTOR (MECH), DRAIN HOSE
F432	3W50712A	HANGER ASSEMBLY, PIVOT
F435	5214FD3663E	HOSE, DRAIN
F436	5214FR4125S	HOSE, INLET
F440	5214FR3188K	HOSE, PUMP
F441	4861FR3068C	CLAMP
F461	4861FR3068E	CLAMP
F462	4861FR3068A	CLAMP
F463	4860FR3092D	CLAMP
F464	4860FR3092C	CLAMP
F465	4860FR3092D	CLAMP
F466	4861FR3068E	CLAMP
F467	4860FR3092C	CLAMP
F468	4861FR3068E	CLAMP
K105	3045ER0008K	TUB ASSEMBLY, OUTER

Loc #	Part No	Description
K110	3045ER1006A	TUB ASSEMBLY, INNER [DRUM]
K111	4433ER1001A	LIFTER ASSEMBLY
K115	4434ER0001A	SPIDER
K121	4280FR4048L	BEARING, BALL
K122	4280FR4048E	BEARING, BALL
K123	4040FR4051C	BOLT ASSEMBLY
K125	4036ER2004A	SEAL
K130	4866ER1013A	BALANCE WEIGHT
K131	1SZZER4002A	SCREW, DRAWING
K135	4866ER0004A	BALANCE WEIGHT
K140	3551ER0003B	TUB COVER ASSEMBLY
K141	4036ER4001B	SEAL
K143	4011FA4353B	BOLT, DRAWING
K310	6322FR2046F	THERMISTOR ASSEMBLY
K311	4036FR4050A	SEAL
K311	4036FR4050A	SEAL
K311	4036FR4050A	SEAL
K320	5301FR1158J	HEATER ASSEMBLY
K340	4681EA2001D	MOTOR ASSEMBLY, PUMP
K342	5214FR4006L	HOSE, CONNECTOR
K344	3108ER1001A	CASING, PUMP
K345	4681EA2001C	MOTOR ASSEMBLY, PUMP
K346	383EER2001A	SERVICE PARTS
K350	4417FA1994G	STATOR ASSEMBLY
K351	6501KW2002A	SENSOR ASSEMBLY
K360	4413EA1002B	ROTOR ASSEMBLY
K410	4970FR2084P	SPRING, HINGE
K411	4930FR3040A	HOLDER
K510	4986ER0002A	GASKET
K511	4974ER2003A	GUIDE,WATER
K512	4932ER4002A	CONNECTOR (MECH), HOSE
K520	4738ER1002A	BELLOWS
K530	4861ER2001D	CLAMP ASSEMBLY
K540	3504ER3002A	CHAMBER, AIR
K550	5214FR4125N	HOSE,INLET
K560	5214FR4006P	HOSE,CONNECTOR
K610	383EER3001E	SERVICE PARTS
M100	5208ER0002A	DUCT, OUTLET
M101	5208ER0001A	DUCT, OUTLET
M110	4681ER1004A	MOTOR ASSEMBLY, FAN

Loc #	Part No	Description
M120	5209ER0002B	DUCT ASSEMBLY
M121	5200ER3001A	PIPE
M130	5214ER4001C	HOSE, INLET
M210	6931FR3108A	THERMOSTAT ASSEMBLY
M215	4036FR4045A	SEAL
M220	5301FR2076G	HEATER ASSEMBLY
M230	6322FR2046C	THERMISTOR ASSEMBLY
M235	6322FR2046J	THERMISTOR ASSEMBLY
M240	6901ER4001A	FUSE ASSEMBLY
M260	4860ER3002A	CLAMP
M310	4738ER2005A	BELLOWS
M311	4860FR3092A	CLAMP
M312	4860FR3092A	CLAMP
	383EER4001A	GASKET PLIER (SPECIAL TOOL)
	383EER4003A	DAMPER PLIER (SPECIAL TOOL)
	383EER4004A	GASKET PLIER (SPECIAL TOOL)
	5214FR3018D	DRAIN HOSE EXTENSION (5 FEET)

Special tool set for front-loader washers. The Putty knife is used only for the Columbus Series.

The stamped wrench is included with the washer.



061130

(this page intentionally blank)

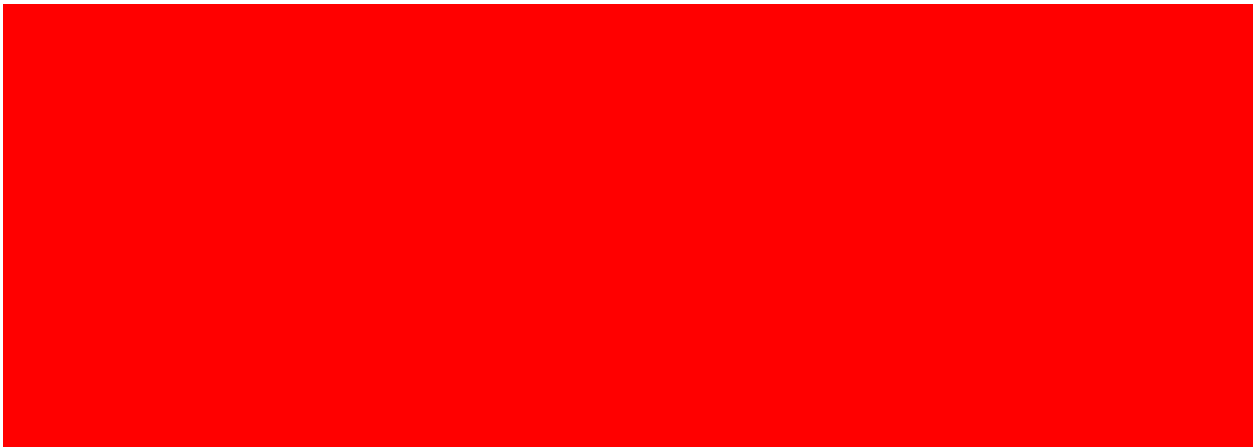

**© 2005 LG Electronics, Inc.
Printed in the USA**